

**OMNIMATE Signal - series B2C/S2C 3.50 - 2-row
S2CD-THR 3.50/36/90G 3.2SN BK BX**

Weidmüller Interface GmbH & Co. KG
 Klingenbergstraße 16
 D-32758 Detmold
 Germany
 Fon: +49 5231 14-0
 Fax: +49 5231 14-292083
 www.weidmueller.com

Product image

Similar to illustration

The new benchmark for component density: the virtual 0.875mm pitch - for 1mm² I/O connections

The only 4-row double level male connectors for standard IP20 sensor interfaces with 3.5 pitch

The S2L in a double pack - a standard has surpassed itself:

- Each 3.5mm wide, 4 I/O contacts for 1mm² connection cross-section
- Force-fit enclosure geometry guarantees maximum stability
- Solder flange eliminates the need for a screw fastening

Less is more - basic advantages for your applications:

- 75% space savings on the circuit board
- Solder flange reduces process costs
- Less mechanical load on the soldering points
- More space for displays in the front panel, for example

A "small" contribution to greater competitiveness: additional features in the same installation space or a more compact device with the same range of functions.

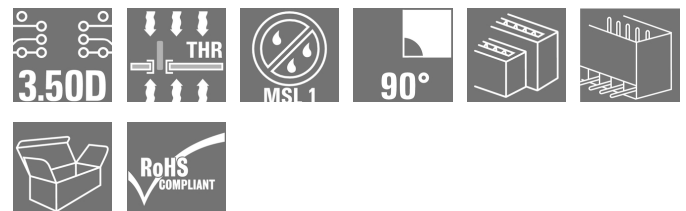
**General ordering data**

Type	S2CD-THR 3.50/36/90G 3.2SN BK BX
Order No.	1357880000
Version	PCB plug-in connector, male header, closed side, THT/THR solder connection, 3.50 mm, No. of poles: 36, 90°, Solder pin length (l): 3.2 mm, tinned, black, Box
GTIN (EAN)	4050118160567
Qty.	20 pc(s).
Product data	IEC: 200 V / 7.9 A UL: 150 V / 9.5 A
Packaging	Box

**OMNIMATE Signal - series B2C/S2C 3.50 - 2-row
S2CD-THR 3.50/36/90G 3.2SN BK BX**

Weidmüller Interface GmbH & Co. KG
 Klingenbergstraße 16
 D-32758 Detmold
 Germany
 Fon: +49 5231 14-0
 Fax: +49 5231 14-292083
 www.weidmueller.com

Technical data**Dimensions and weights**

Width	32.9 mm	Width (inches)	1.295 inch
Height	35 mm	Height (inches)	1.378 inch
Height of lowest version	31.8 mm	Depth	24.4 mm
Depth (inches)	0.961 inch	Net weight	18.5 g

System specifications

Product family	OMNIMATE Signal - series B2C/S2C 3.50 - 2-row	Type of connection	Board connection
Mounting onto the PCB	THT/THR solder connection	Pitch in mm (P)	3.5 mm
Pitch in inches (P)	0.138 inch	Outgoing elbow	90°
No. of poles	36	Number of solder pins per pole	1
Solder pin length (l)	3.2 mm	Solder pin dimensions	d = 1.0 mm, Octagonal
Solder eyelet hole diameter (D)	1.3 mm	Solder eyelet hole diameter tolerance (D)+	0, 1 mm
Outside diameter of solder pad	2.1 mm	Template aperture diameter	1.9 mm
L1 in mm	59.5 mm	L1 in inches	2.343 inch
Pin series quantity	2	Touch-safe protection acc. to DIN VDE 57 106	Safe from finger touch
Touch-safe protection acc. to DIN VDE 0470	IP 20	Can be coded	Yes
Plugging cycles	25		

Material data

Insulating material	LCP GF	Colour	black
Colour chart (similar)	RAL 9011	Insulating material group	IIIb
CTI	≥ 175	Insulation strength	≥ 10 ⁸ Ω
Moisture Level (MSL)	1	UL 94 flammability rating	V-0
GWIT	930 °C	GWFI	960 °C
Contact material	Copper alloy	Contact surface	tinned
Layer structure of solder connection	1-3 µm Ni / 2-5 µm Sn matt	Storage temperature, min.	-25 °C
Storage temperature, max.	55 °C	Max. relative humidity during storage	80 %
Operating temperature, min.	-50 °C	Operating temperature, max.	120 °C
Temperature range, installation, min.	-40 °C	Temperature range, installation, max.	120 °C

Rated data acc. to IEC

tested acc. to standard	IEC 60664-1, IEC 61984	Rated current, min. no. of poles (Tu=20°C)	7.9 A
Rated current, max. no. of poles (Tu=20°C)	5 A	Rated current, min. no. of poles (Tu=40°C)	6.8 A
Rated current, max. no. of poles (Tu=40°C)	5 A	Rated voltage for surge voltage class / pollution degree II/2	200 V
Rated voltage for surge voltage class / pollution degree III/2	160 V	Rated voltage for surge voltage class / pollution degree III/3	100 V
Rated impulse voltage for surge voltage class/ pollution degree II/2	2.5 kV	Rated impulse voltage for surge voltage class/ pollution degree III/2	2.5 kV
Rated impulse voltage for surge voltage class/ contamination degree III/3	1.5 kV	Short-time withstand current resistance	3 x 1s with 80 A

**OMNIMATE Signal - series B2C/S2C 3.50 - 2-row
S2CD-THR 3.50/36/90G 3.2SN BK BX**

Weidmüller Interface GmbH & Co. KG
 Klingenbergstraße 16
 D-32758 Detmold
 Germany
 Fon: +49 5231 14-0
 Fax: +49 5231 14-292083
 www.weidmueller.com

Technical data**Rated data acc. to CSA**

Institute (CSA)		Certificate No. (CSA)	200039-1121690
Rated voltage (Use group B / CSA)	50 V	Rated voltage (Use group C / CSA)	50 V
Rated voltage (Use group D / CSA)	150 V	Rated current (Use group B / CSA)	5 A
Rated current (Use group C / CSA)	9.5 A	Rated current (Use group D / CSA)	9.5 A
Reference to approval values	Specifications are maximum values, details - see approval certificate.		

Rated data acc. to UL 1059

Institute (cURus)		Certificate No. (cURus)	E60693
Rated voltage (Use group B / UL 1059)	150 V	Rated voltage (Use group C / UL 1059)	50 V
Rated voltage (Use group D / UL 1059)	50 V	Rated current (Use group B / UL 1059)	9.5 A
Rated current (Use group C / UL 1059)	9.5 A	Rated current (Use group D / UL 1059)	9.5 A
Reference to approval values	Specifications are maximum values, details - see approval certificate.		

Packing

Packaging	Box	VPE length	43 mm
VPE width	125 mm	VPE height	143 mm

Classifications

ETIM 4.0	EC002637	ETIM 5.0	EC002637
ETIM 6.0	EC002637	eClass 6.2	27-26-07-04
eClass 7.1	27-44-04-02	eClass 8.1	27-44-04-02
eClass 9.0	27-44-04-02	eClass 9.1	27-44-04-02

Notes

Notes	<ul style="list-style-type: none"> • Gold-plated contact surfaces on request • Rated current related to rated cross-section & min. No. of poles. • Spacing between rows: see hole layout • P on drawing = pitch • Rated data refer only to the component itself. Clearance and creepage distances to other components are to be designed in accordance with the relevant application standards.
IPC conformity	Conformity: The products are developed, manufactured and delivered according international recognized standards and norms and comply with the assured properties in the data sheet resp. fulfill decorative properties in accordance with IPC-A-610 "Class 2". Further claims on the products can be evaluated on request.

Data sheet**OMNIMATE Signal - series B2C/S2C 3.50 - 2-row
S2CD-THR 3.50/36/90G 3.2SN BK BX**

Weidmüller Interface GmbH & Co. KG
Klingenbergstraße 16
D-32758 Detmold
Germany
Fon: +49 5231 14-0
Fax: +49 5231 14-292083
www.weidmueller.com

Technical data**Approvals**

Approvals



ROHS

Conform

DownloadsApproval/Certificate/Document of
Conformity[Declaration of the Manufacturer](#)

Brochure/Catalogue

[FL DRIVES EN](#)
[MB DEVICE MANUF. EN](#)
[FL DRIVES DE](#)
[CAT 2 PORTFOLIOGUIDE EN](#)
[FL BUILDING SAFETY EN](#)
[FL APPL LED LIGHTING EN](#)
[FL INDUSTR.CONTROLS EN](#)
[FL MACHINE SAFETY EN](#)
[FL HEATING ELECTR EN](#)
[FL APPL INVERTER EN](#)
[FL_BASE_STATION_EN](#)
[FL ELEVATOR EN](#)
[FL POWER SUPPLY EN](#)
[FL 72H SAMPLE SER EN](#)
[PO OMNIMATE EN](#)

SMT white paper

[Download Whitepaper](#)

**OMNIMATE Signal - series B2C/S2C 3.50 - 2-row
S2CD-THR 3.50/36/90G 3.2SN BK BX**

Weidmüller Interface GmbH & Co. KG
 Klingenbergstraße 16
 D-32758 Detmold
 Germany
 Fon: +49 5231 14-0
 Fax: +49 5231 14-292083
 www.weidmueller.com

Drawings

Dimensional drawing

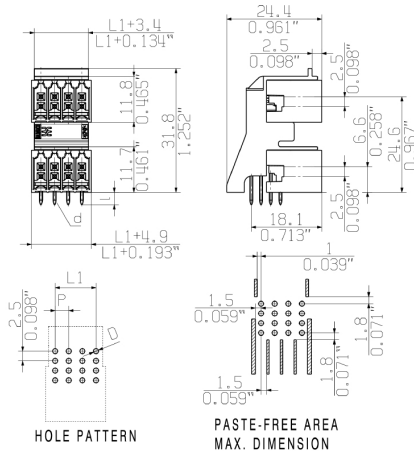

MASSE OHNE TOLERANZ SIND KEINE PRUEFMASSE
 DIMS. WITHOUT TOLERANCE ARE NOT CONTROL DIMS.

ALLGEMEINGUELTIGE KUNDENZEICHUNG, AKTUELLER STAND NUR AUF ANFRAGE
 GENERAL CUSTOMER DRAWING, TOPICAL VERSION ONLY IF REQUIRED

DIE DEUTSCHE VERSION IST VERBINDLICH
 THE GERMAN VERSION IS BINDING

WEITERGABE SOWIE VERVIELFAELTIGUNG DIESER DOKUMENTS, VERWERTUNG SEINER INHALTS SIND VERBOTEN, SOWEIT NICHT AUSDRUECKLICH GESTATTET.
 ZUWIDERHANDLUNGEN VERPFLICHTEN ZU SCHADENERSATZ. ALLE RECHTE FUER DEN FALL DER PATENT-, GEBRAUCHSMUSTER- ODER GESCHMACKSMUSTERREINTRAGUNG VORBEHALTEN.
 THE REPRODUCTION, DISTRIBUTION AND UTILIZATION OF THIS DOCUMENT AS WELL AS THE COMMUNICATION OF ITS CONTENTS TO OTHERS WITHOUT EXPLICIT AUTHORIZATION IS PROHIBITED.
 OFFENDERS WILL BE HELD LIABLE FOR THE PAYMENT OF DAMAGES. WEIDMUELLER EXCLUSIVELY RESERVES THE RIGHT TO FILE FOR PATENTS, UTILITY MODELS OR DESIGNS.
 © WEIDMUELLER INTERFACE GmbH & Co.KG

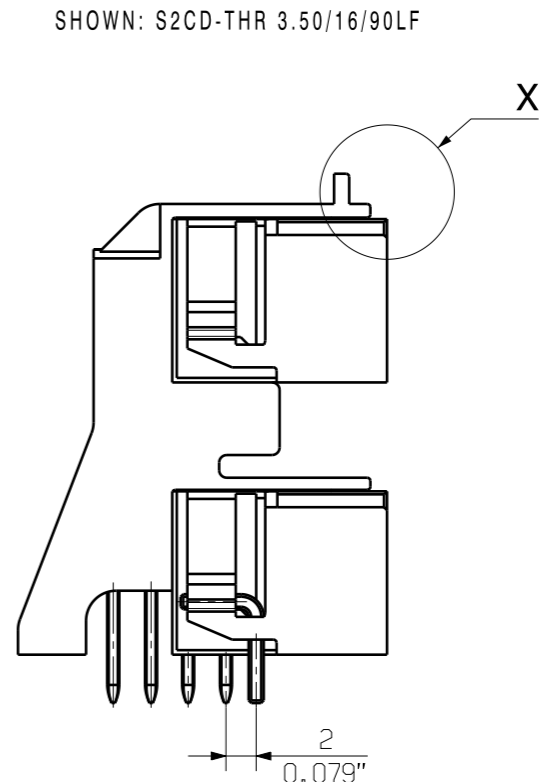
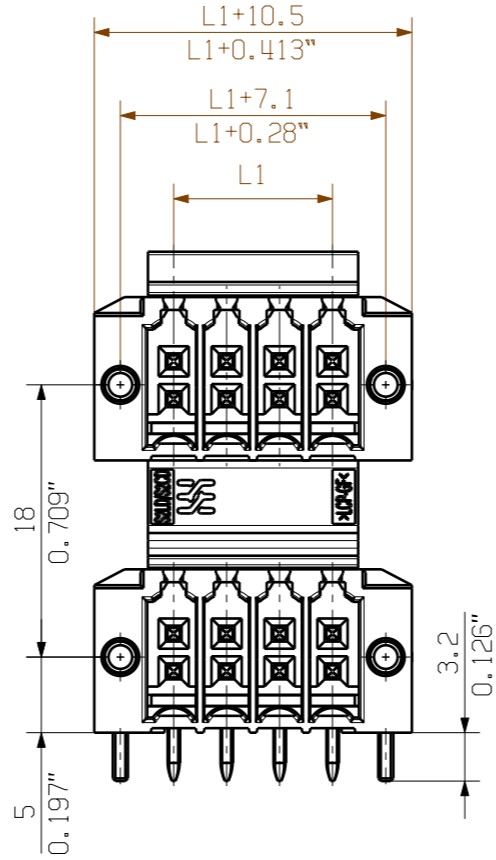
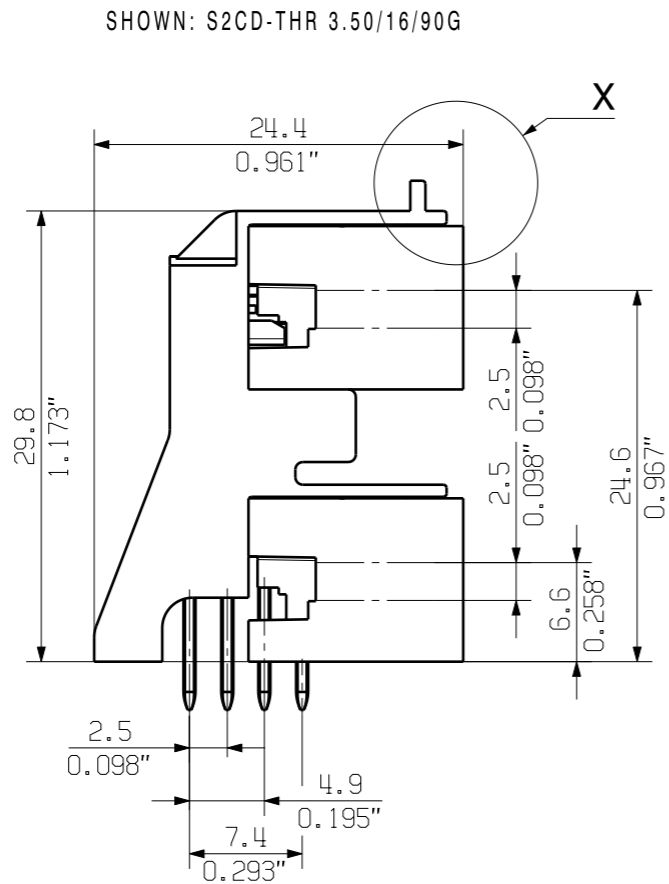
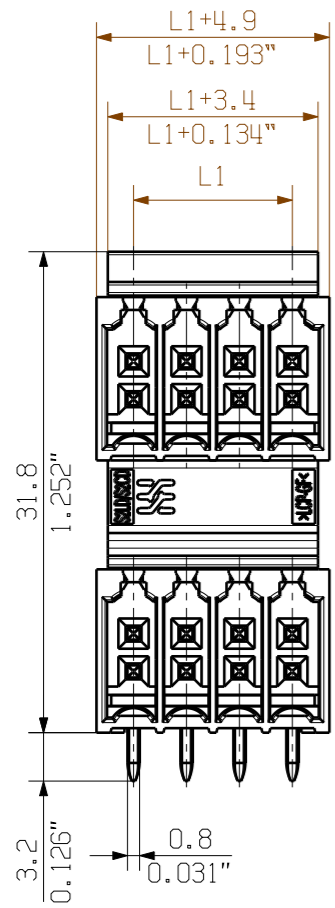

M 1/1
 S2CD-THR 3.50/16/90G

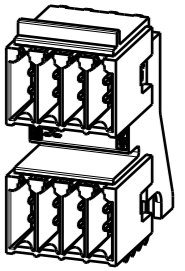

M 1/1
 S2CD-THR 3.50/16/90LF

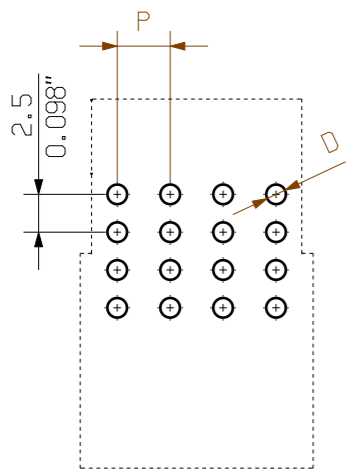
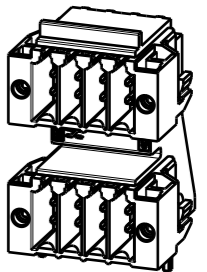

HOLE PATTERN

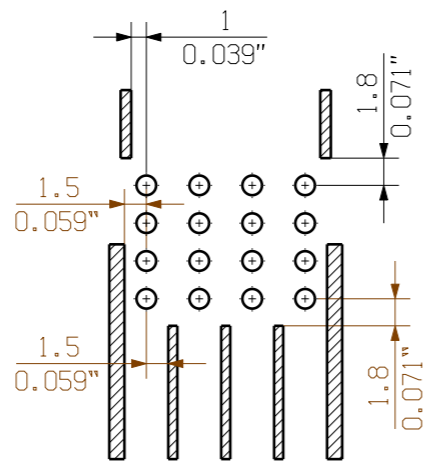

PASTE FREE AREA
 MAX. DIMENSION

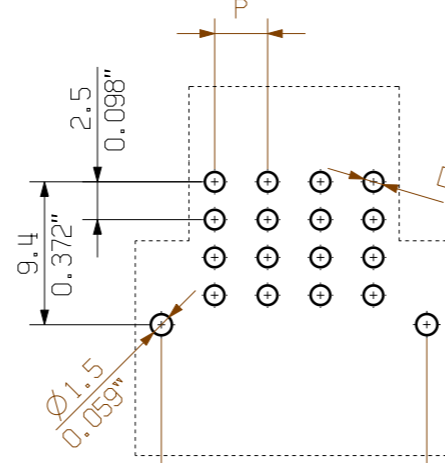

HOLE PATTERN

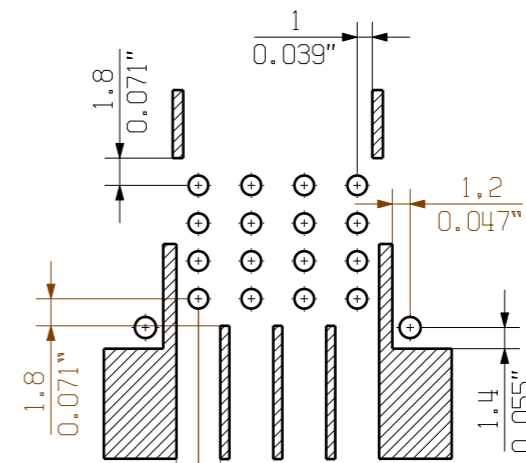

PASTE FREE AREA
 MAX. DIMENSION

X 4/1
 ACHTUNG
 ATTENTION

ABSTUEZUNG ERFORDERLICH
 SUPPORT NECESSARY
 BEI ALLEN VERSIONEN
 FOR ALL VERSIONS

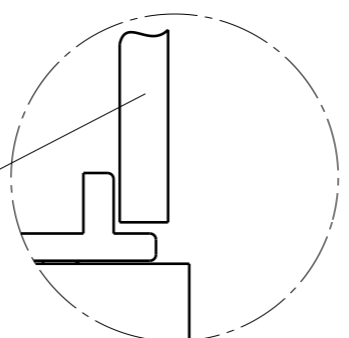

For the mounting of PCBs, it should be noted that the rated data relates only to the PCB components alone. The necessary creepage and clearance paths must be observed in connection with the respective applicant in accordance to IEC 664 / VDE 0110. The current-carrying capacity and pitch tolerance is to be determined according to DIN IEC 326 part 3 very fine.

Weidmüller PCB components are tested to the DIN EN 61984 standard, and are valid for its field of application. Provided that the components are used to the intended purpose, all requirements with respect to the occurring of electrical, mechanical, thermic and corrosive stress will be satisfied.

36	59.5	2.343
32	52.5	2.067
28	45.5	1.791
24	38.5	1.516
20	31.5	1.240
16	24.5	0.965
12	17.5	0.689
8	10.5	0.413
n	POLZAHL POLES	L1 [mm] L1 [inch]

P = 3.50 RASTER PITCH
 D = Ø1.3 +0.1 / 0.051
 d = 0.8x0.8 / 0.031"x0.031"

GENERAL TOLERANCE: DIN ISO 2768-m		74586/5 01.07.14 TIELKER_S 01		CAT.NO.:	
RoHS COMPLIANT		MODIFICATION		Weidmüller	
DRAWN		DATE	NAME	DRAWING NO. C 55770 01	
RESPONSIBLE		07.07.2014	HELI5_MA	SHEET 01 OF 01 SHEETS	
CHECKED		APPROVED		ISSUE NO.	
SCALE: 2/1		HANKE_D		S2CD-THR 3.50/.../90	
SUPERSEDES: .		PRODUCT FILE: B2CF/S2C		STIFTLISTE MALE HEADER	
				7400	

Recommended wave soldering profiles

Weidmüller Interface GmbH & Co. KG
 Klängenbergstraße 16
 D-32758 Detmold
 Germany
 Fon: +49 5231 14-0
 Fax: +49 5231 14-292083
 www.weidmueller.com

Single Wave:



Double Wave:



Wave soldering profiles

Wired connection elements should be processed in accordance with the DIN EN 61760-1 standard. We have included two recommendations for practical wave soldering profiles, with which Weidmüller PCB terminals and connectors are qualified.

When choosing a suitable profile for your application, the following factors also need to be considered:

- PCB thickness
- Proportion of Cu in the layers
- Single/double-sided assembly
- Product range
- Heating and cooling rates

The single and double wave profiles each indicate the recommended operating range, including the maximum soldering temperature of 260°C. In practice, the maximum soldering temperature is quite often well below the above maximum profile.

Recommended reflow soldering profile

Weidmüller Interface GmbH & Co. KG
 Klingenbergstraße 16
 D-32758 Detmold
 Germany
 Fon: +49 5231 14-0
 Fax: +49 5231 14-292083
 www.weidmueller.com



Reflow soldering profile

The perfect soldering profile for SMT Surface Mount Technology is one the most exiting question in SMT production. But there are more than one correct answer: The diagram of temperature-on-time is related to processing features of solder paste and to maximum load of components.

We have to consider the following parameters:

- Time for pre heating
- Maximum temperature
- Time above melting point
- Time for cooling
- Maximum heating rate
- Maximum cooling rate

We recommend a typical solder profile with associated process limits. With preheating components and board are prepared smoothly for the solder phase. Heating rate is typically $\leq +3\text{K/s}$. In parallel the solder paste is ‚activated‘. The time above melting point of 217°C the paste gets liquid and components and boards begin to connect. The maximum temperature of 245°C to 254°C should stay between 10 and 40 seconds. In the cooling phase at $\geq -6\text{K/s}$ solder is cured. Board and components cool down while avoiding cold cracks.