

**Data sheet | Item number: 2042-3839**

Relay module; Nominal input voltage: 24 ... 230 V AC/DC; 1 changeover contact; Limiting continuous current: 4 A; Green status indicator; Module width: 15 mm

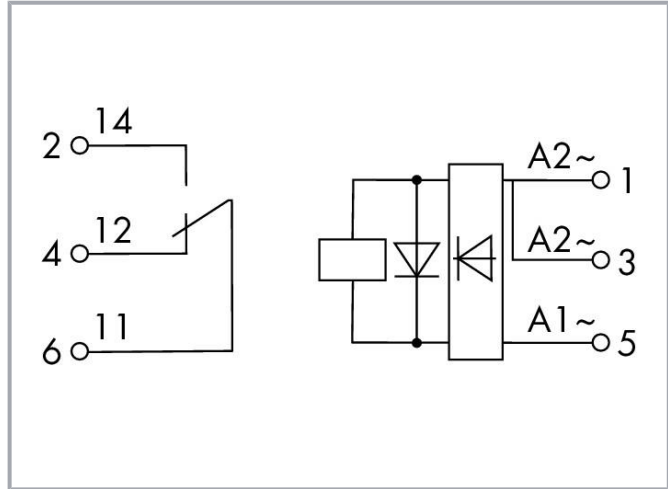

[www.wago.com/2042-3839](http://www.wago.com/2042-3839)

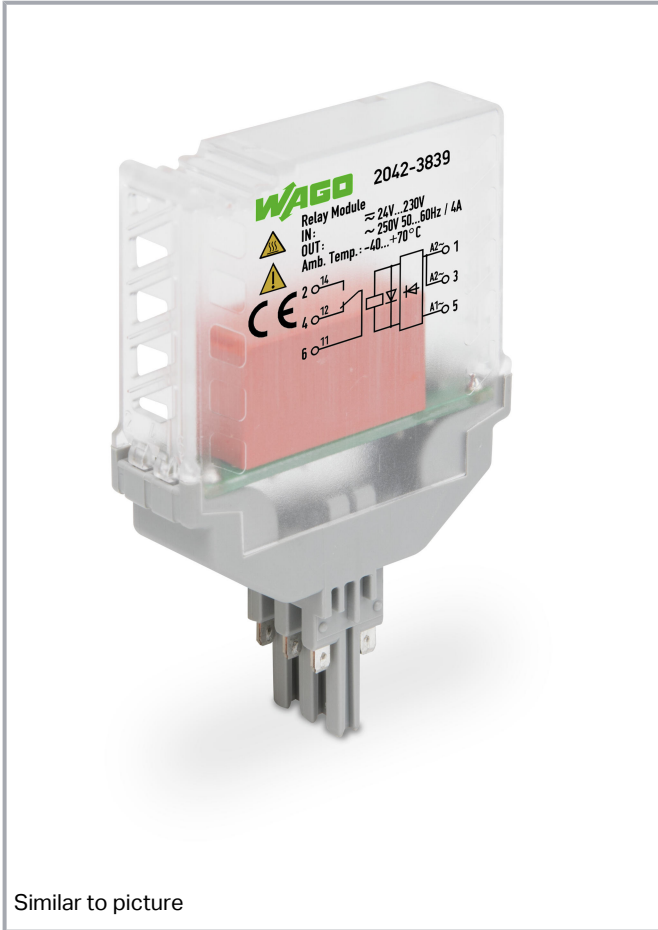

Similar to picture

Subject to changes. Please also observe the further product documentation!

WAGO Kontakttechnik GmbH & Co. KG  
Hansastr. 27  
32423 Minden  
Phone: +49571 887-0 | Fax: +49571 887-169  
Email: [info.de@wago.com](mailto:info.de@wago.com) | Web: [www.wago.com](http://www.wago.com)

Do you have any questions about our products?  
We are always happy to take your call at +49 (571) 887-44222.

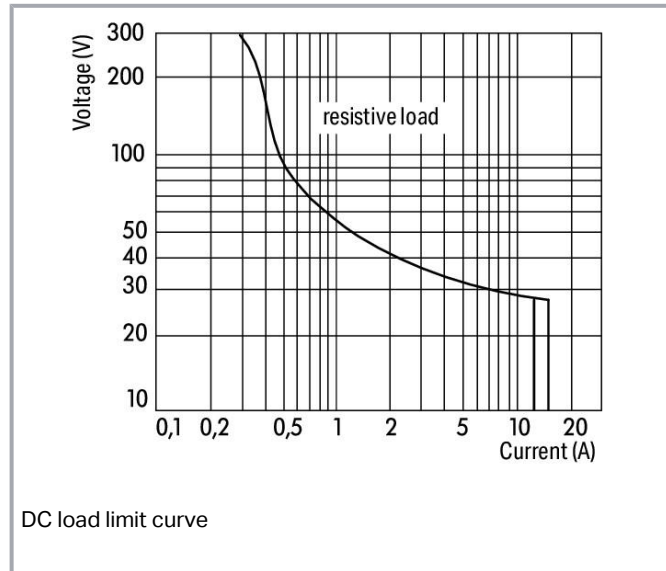
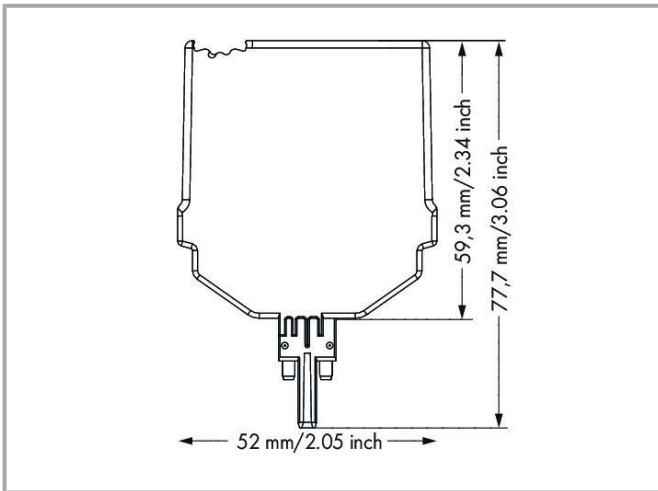

## Data

### Technical data

### Control circuit

Nominal input voltage $U_N$	AC/DC 24 ... 230 V
Input voltage range	$\pm 10\%$
Nominal input current at $U_N$	6 mA (230 V); 50.2 mA (24 V)

### Load circuit

Number of changeover/switchover contacts	1
Contact material (relay)	AgNi
Limiting continuous current	4 A
Inrush current (resistive) (max.)	(AC) 30 A / 4 s
Switching voltage (max.)	AC 250 V
Switching power (resistive) (max.)	AC 1000 VA; DC (see load limit curve)
Switching capacity	AC-15: 6 A / AC 250 V; DC-13: 2 A / DC 24 V
Recommended minimum load	12 V / 10 mA
Pull-in time (typ.)	8 ms
Drop-out time (typ.)	6 ms
Bounce time (typ.)	4 ms
Electrical life (NO; resistive load; 23 °C)	$100 \times 10^3$ switching operations

Subject to changes. Please also observe the further product documentation!

Mechanical life	10 x 10 <sup>6</sup> switching operations
-----------------	---

## Signaling

Status indicator	Green LED
------------------	-----------

## Safety and protection

Rated voltage	250 V
Pollution degree	2
Dielectric strength, control/load circuit (AC, 1 min)	3 kVrms
Dielectric strength, open contact (AC, 1 min)	1 kVrms
Protection type	IP20

## Physical data

Width	15.5 mm / 0.61 inch
Height	77.7 mm / 3.059 inch
Height from the surface	59.3 mm / 2.335 inch
Depth	52 mm / 2.047 inch

## Mechanical data

Mounting type	Pluggable module for TOPJOB <sup>®</sup> S carrier terminal block
---------------	---

## Material data

Flammability class per UL94	V0
Weight	36.3 g

## Environmental requirements

Surrounding air temperature (operation at U <sub>N</sub> )	-40 ... 70 °C
Surrounding air temperature (storage)	-40 ... 85 °C
Processing temperature	-25 ... +50 °C
Operating altitude (max.)	2000 m

## Standards and specifications

Standards/Specifications	EN 61010-2-201; EN 61373; EN 50121-3-2
--------------------------	--

Subject to changes. Please also observe the further product documentation!

## Commercial data

Packaging type	BOX
Country of origin	DE
GTIN	4055143651943
Customs tariff number	85364900990





## Approvals / Certificates

### UL-Approvals





Logo	Approval	Additional Approval Text	Certificate name
	<b>UL</b> Underwriters Laboratories Inc. (ORDINARY LOCATIONS)	UL 61010-1	E175199

## Compatible products

### clamps









	<b>Item no.: 2002-1661</b> 2-conductor carrier terminal block; for DIN-rail 35 x 15 and 35 x 7.5; 2.5 mm <sup>2</sup> ; Push-in CAGE CLAMP®; 2,50 mm <sup>2</sup> ; gray	<a href="http://www.wago.com/2002-1661">www.wago.com/2002-1661</a>
	<b>Item no.: 2002-1761</b> 3-conductor carrier terminal block; for DIN-rail 35 x 15 and 35 x 7.5; 2.5 mm <sup>2</sup> ; Push-in CAGE CLAMP®; 2,50 mm <sup>2</sup> ; gray	<a href="http://www.wago.com/2002-1761">www.wago.com/2002-1761</a>
	<b>Item no.: 2002-1861</b> 4-conductor carrier terminal block; for DIN-rail 35 x 15 and 35 x 7.5; 2.5 mm <sup>2</sup> ; Push-in CAGE CLAMP®; 2,50 mm <sup>2</sup> ; gray	<a href="http://www.wago.com/2002-1861">www.wago.com/2002-1861</a>
	<b>Item no.: 2002-1961</b> 2-conductor carrier terminal block; with additional jumper position; for DIN-rail 35 x 15 and 35 x 7.5; 2.5 mm <sup>2</sup> ; Push-in CAGE CLAMP®; 2,50 mm <sup>2</sup> ; gray	<a href="http://www.wago.com/2002-1961">www.wago.com/2002-1961</a>

### Marking accessories















	<b>Item no.: 2009-110</b> Marking strips; for Smart Printer; on reel; not stretchable; plain; snap-on type; white	<a href="http://www.wago.com/2009-110">www.wago.com/2009-110</a>
	<b>Item no.: 2009-115</b> WMB-Inline; for Smart Printer; 1500 pieces on roll; stretchable 5 - 5.2 mm; plain; snap-on type; white	<a href="http://www.wago.com/2009-115">www.wago.com/2009-115</a>
	<b>Item no.: 2009-115/000-002</b> WMB-Inline; for Smart Printer; 1500 pieces on roll; stretchable 5 - 5.2 mm; plain; snap-on type; yellow	<a href="http://www.wago.com/2009-115/000-002">www.wago.com/2009-115/000-002</a>
	<b>Item no.: 2009-115/000-006</b> WMB-Inline; for Smart Printer; 1500 pieces on roll; stretchable 5 - 5.2 mm; plain; snap-on type; blue	<a href="http://www.wago.com/2009-115/000-006">www.wago.com/2009-115/000-006</a>

Subject to changes. Please also observe the further product documentation!



*	<b>Item no.: 2009-115/000-007</b> WMB-Inline; for Smart Printer; 1500 pieces on roll; stretchable 5 - 5.2 mm; plain; snap-on type; gray	<a href="http://www.wago.com/2009-115/000-007">www.wago.com/2009-115/000-007</a>
*	<b>Item no.: 2009-115/000-012</b> WMB-Inline; for Smart Printer; 1500 pieces on roll; stretchable 5 - 5.2 mm; plain; snap-on type; orange	<a href="http://www.wago.com/2009-115/000-012">www.wago.com/2009-115/000-012</a>
*	<b>Item no.: 2009-115/000-017</b> WMB-Inline; for Smart Printer; 1500 pieces on roll; stretchable 5 - 5.2 mm; plain; snap-on type; light green	<a href="http://www.wago.com/2009-115/000-017">www.wago.com/2009-115/000-017</a>
*	<b>Item no.: 2009-115/000-023</b> WMB-Inline; for Smart Printer; 1500 pieces on roll; stretchable 5 - 5.2 mm; plain; snap-on type; green	<a href="http://www.wago.com/2009-115/000-023">www.wago.com/2009-115/000-023</a>
*	<b>Item no.: 2009-115/000-024</b> WMB-Inline; for Smart Printer; 1500 pieces on roll; stretchable 5 - 5.2 mm; plain; snap-on type; violet	<a href="http://www.wago.com/2009-115/000-024">www.wago.com/2009-115/000-024</a>
	<b>Item no.: 793-501</b> WMB marking card; as card; not stretchable; plain; snap-on type; white	<a href="http://www.wago.com/793-501">www.wago.com/793-501</a>
	<b>Item no.: 793-501/000-002</b> WMB marking card; as card; not stretchable; plain; snap-on type; yellow	<a href="http://www.wago.com/793-501/000-002">www.wago.com/793-501/000-002</a>
	<b>Item no.: 793-501/000-005</b> WMB marking card; as card; not stretchable; plain; snap-on type; red	<a href="http://www.wago.com/793-501/000-005">www.wago.com/793-501/000-005</a>
	<b>Item no.: 793-501/000-006</b> WMB marking card; as card; not stretchable; plain; snap-on type; blue	<a href="http://www.wago.com/793-501/000-006">www.wago.com/793-501/000-006</a>
	<b>Item no.: 793-501/000-007</b> WMB marking card; as card; not stretchable; plain; snap-on type; gray	<a href="http://www.wago.com/793-501/000-007">www.wago.com/793-501/000-007</a>
	<b>Item no.: 793-501/000-012</b> WMB marking card; as card; not stretchable; plain; snap-on type; orange	<a href="http://www.wago.com/793-501/000-012">www.wago.com/793-501/000-012</a>
	<b>Item no.: 793-501/000-017</b> WMB marking card; as card; not stretchable; plain; snap-on type; light green	<a href="http://www.wago.com/793-501/000-017">www.wago.com/793-501/000-017</a>
	<b>Item no.: 793-501/000-023</b> WMB marking card; as card; not stretchable; plain; snap-on type; green	<a href="http://www.wago.com/793-501/000-023">www.wago.com/793-501/000-023</a>
	<b>Item no.: 793-501/000-024</b> WMB marking card; as card; not stretchable; plain; snap-on type; violet	<a href="http://www.wago.com/793-501/000-024">www.wago.com/793-501/000-024</a>

Subject to changes. Please also observe the further product documentation!

	<b>Item no.: 793-5501</b> WMB marking card; as card; for terminal block width 5 - 17.5 mm; stretchable 5 - 5.2 mm; plain; snap-on type; white	<a href="http://www.wago.com/793-5501">www.wago.com/793-5501</a>
	<b>Item no.: 793-5501/000-002</b> WMB marking card; as card; for terminal block width 5 - 17.5 mm; stretchable 5 - 5.2 mm; plain; snap-on type; yellow	<a href="http://www.wago.com/793-5501/000-002">www.wago.com/793-5501/000-002</a>
	<b>Item no.: 793-5501/000-005</b> WMB marking card; as card; for terminal block width 5 - 17.5 mm; stretchable 5 - 5.2 mm; plain; snap-on type; red	<a href="http://www.wago.com/793-5501/000-005">www.wago.com/793-5501/000-005</a>
	<b>Item no.: 793-5501/000-006</b> WMB marking card; as card; for terminal block width 5 - 17.5 mm; stretchable 5 - 5.2 mm; plain; snap-on type; blue	<a href="http://www.wago.com/793-5501/000-006">www.wago.com/793-5501/000-006</a>
	<b>Item no.: 793-5501/000-007</b> WMB marking card; as card; for terminal block width 5 - 17.5 mm; stretchable 5 - 5.2 mm; plain; snap-on type; gray	<a href="http://www.wago.com/793-5501/000-007">www.wago.com/793-5501/000-007</a>
	<b>Item no.: 793-5501/000-012</b> WMB marking card; as card; for terminal block width 5 - 17.5 mm; stretchable 5 - 5.2 mm; plain; snap-on type; orange	<a href="http://www.wago.com/793-5501/000-012">www.wago.com/793-5501/000-012</a>
	<b>Item no.: 793-5501/000-014</b> WMB marking card; as card; for terminal block width 5 - 17.5 mm; stretchable 5 - 5.2 mm; plain; snap-on type; brown	<a href="http://www.wago.com/793-5501/000-014">www.wago.com/793-5501/000-014</a>
	<b>Item no.: 793-5501/000-017</b> WMB marking card; as card; for terminal block width 5 - 17.5 mm; stretchable 5 - 5.2 mm; plain; snap-on type; green	<a href="http://www.wago.com/793-5501/000-017">www.wago.com/793-5501/000-017</a>
	<b>Item no.: 793-5501/000-023</b> WMB marking card; as card; for terminal block width 5 - 17.5 mm; stretchable 5 - 5.2 mm; plain; snap-on type; light green	<a href="http://www.wago.com/793-5501/000-023">www.wago.com/793-5501/000-023</a>
	<b>Item no.: 793-5501/000-024</b> WMB marking card; as card; for terminal block width 5 - 17.5 mm; stretchable 5 - 5.2 mm; plain; snap-on type; violet	<a href="http://www.wago.com/793-5501/000-024">www.wago.com/793-5501/000-024</a>
<b>End plate</b>		
	<b>Item no.: 2002-1691</b> End and intermediate plate; 1 mm thick; gray	<a href="http://www.wago.com/2002-1691">www.wago.com/2002-1691</a>
	<b>Item no.: 2002-1692</b> End and intermediate plate; 1 mm thick; orange	<a href="http://www.wago.com/2002-1692">www.wago.com/2002-1692</a>
	<b>Item no.: 2002-1791</b> End and intermediate plate; 1 mm thick; gray	<a href="http://www.wago.com/2002-1791">www.wago.com/2002-1791</a>
	<b>Item no.: 2002-1792</b> End and intermediate plate; 1 mm thick; orange	<a href="http://www.wago.com/2002-1792">www.wago.com/2002-1792</a>

Subject to changes. Please also observe the further product documentation!



	<b>Item no.: 2002-1891</b> End and intermediate plate; 1 mm thick; gray	<a href="http://www.wago.com/2002-1891">www.wago.com/2002-1891</a>
	<b>Item no.: 2002-1892</b> End and intermediate plate; 1 mm thick; orange	<a href="http://www.wago.com/2002-1892">www.wago.com/2002-1892</a>

**Downloads  
Documentation**

**Bid Text**

2042-3839 X81 - Datei	2019 Feb 19	xml 3.9 kB	Download
2042-3839 docx - Datei	2019 Feb 20	docx 17.3 kB	Download

**Instruction Leaflet**

Pluggable Relay Module / Pluggable Solid-State Relay Module	V 1.1.0	pdf 2.0 MB	Download
---	---------	---------------	----------

**Additional Information**

Disposal; Electrical and electronic equipment, Packaging	V 1.0.0	pdf 265.8 kB	Download
--	---------	-----------------	----------

**CAD/CAE-Data**

**CAD data**

2D/3D Models 2042-3839	URL	Download
------------------------	-----	----------

**CAE data**

ZUKEN Portal 2042-3839	URL	Download
------------------------	-----	----------

**Environmental Product Compliance**

**Compliance Search**

Environmental Product Compliance 2042-3839 Relay module; Nominal input voltage: 24 ... 230 V AC/DC; 1 changeover contact; Limiting continuous current: 4 A; Green status indicator; Module width: 15 mm	URL	Download
---	-----	----------

Subject to changes. Please also observe the further product documentation!



## Installation Notes

Subject to changes. Please also observe the further product documentation!

---

WAGO Kontakttechnik GmbH & Co. KG  
Hansastr. 27  
32423 Minden  
Phone: +49571 887-0 | Fax: +49571 887-169  
Email: [info.de@wago.com](mailto:info.de@wago.com) | Web: [www.wago.com](http://www.wago.com)

Do you have any questions about our products?  
We are always happy to take your call at +49 (571) 887-44222.