

Data sheet | Item number: 2042-3829

Relay module; Nominal input voltage: 24 ... 230 V AC/DC; 4 make contacts;
Limiting continuous current: 3 A; Green status indicator; Module width: 25 mm

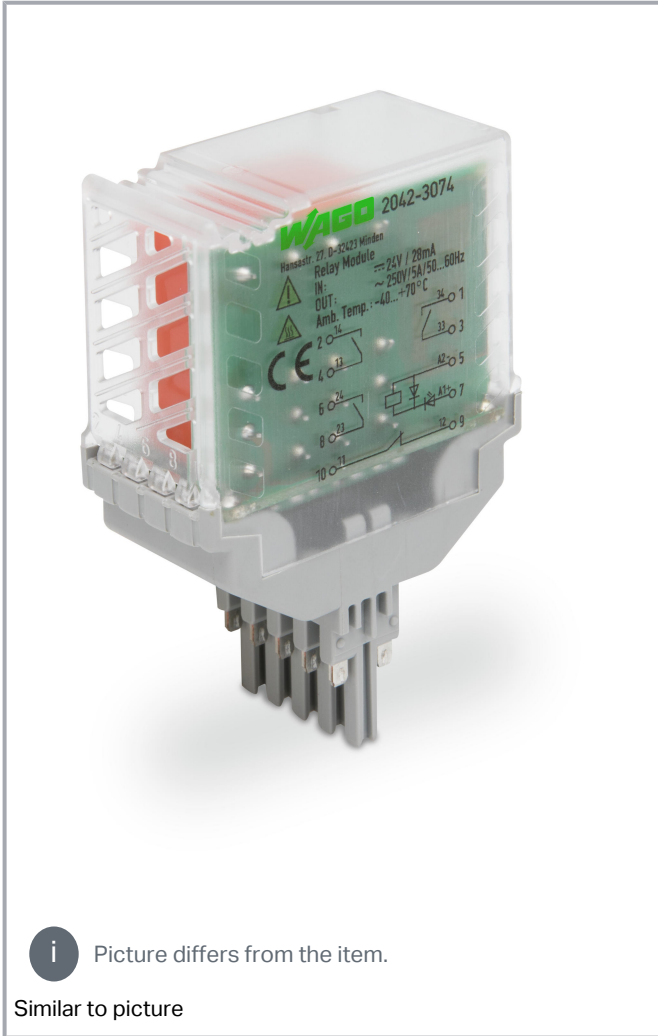

www.wago.com/2042-3829



 Picture differs from the item.

Similar to picture

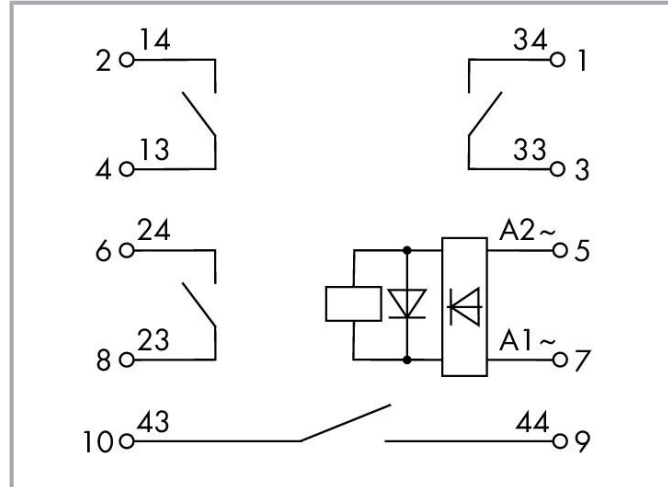

Subject to changes. Please also observe the further product documentation!

WAGO Kontakttechnik GmbH & Co. KG
Hansastr. 27
32423 Minden
Phone: +49571 887-0 | Fax: +49571 887-169
Email: info.de@wago.com | Web: www.wago.com

Do you have any questions about our products?
We are always happy to take your call at +49 (571) 887-44222.

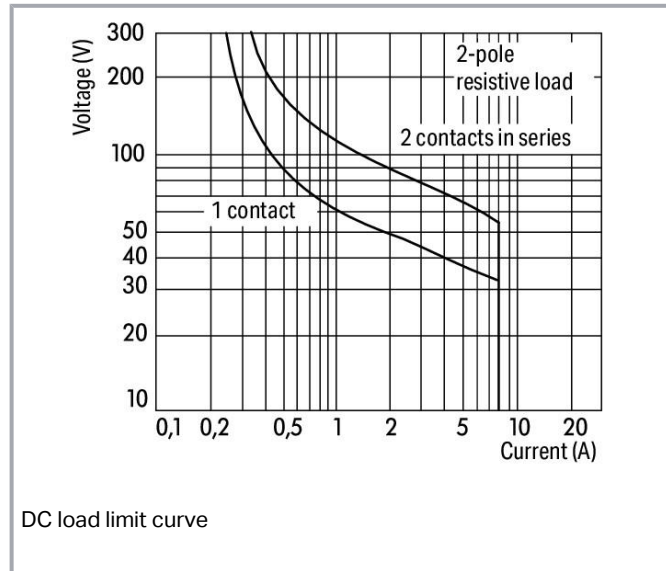
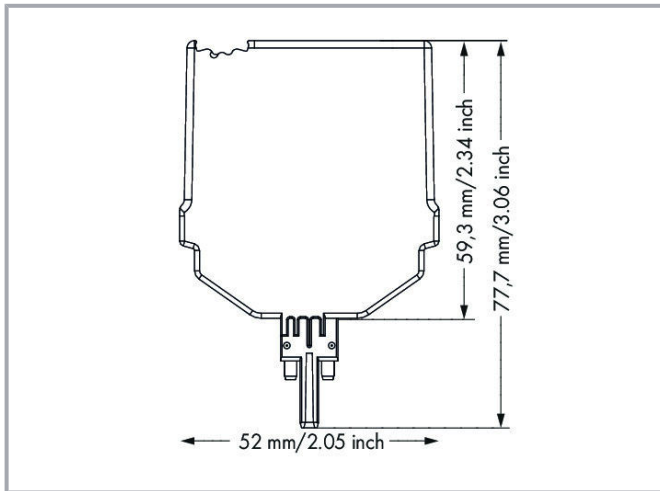

Data

Technical data

Control circuit

Nominal input voltage U_N	AC/DC 24 ... 230 V
Input voltage range	$\pm 10\%$
Nominal input current at U_N	6 mA (230 V); 58.4 mA (24 V)

Load circuit

Number of make/switch-on contacts	4
Contact material (relay)	AgNi
Limiting continuous current	3 A
Inrush current (resistive) (max.)	(AC) 15 A / 4 s
Switching voltage (max.)	AC 250 V
Switching power (resistive) (max.)	AC 750 VA; DC (see load limit curve)
Recommended minimum load	12 V / 10 mA
Pull-in time (typ.)	8 ms
Drop-out time (typ.)	6 ms
Bounce time (typ.)	4 ms
Electrical life (NO; resistive load; 23 °C)	100×10^3 switching operations
Mechanical life	10×10^6 switching operations

Subject to changes. Please also observe the further product documentation!



Signaling

Status indicator	Green LED
------------------	-----------

Safety and protection

Rated voltage	250 V
Pollution degree	2
Dielectric strength, control/load circuit (AC, 1 min)	3 kV _{rms}
Dielectric strength, open contact (AC, 1 min)	1 kV _{rms}
Dielectric strength, channel/channel (AC, 1 min.)	1.5 kV _{rms}
Protection type	IP20

Physical data

Width	25.9 mm / 1.02 inch
Height	77.7 mm / 3.059 inch
Height from the surface	59.3 mm / 2.335 inch
Depth	52 mm / 2.047 inch

Mechanical data

Mounting type	Pluggable module for TOPJOB [®] S carrier terminal block
---------------	---

Material data

Flammability class per UL94	V0
Weight	59.5 g

Environmental requirements

Surrounding air temperature (operation at U _N)	-40 ... 50 °C
Surrounding air temperature (storage)	-40 ... 85 °C
Processing temperature	-25 ... +50 °C
Operating altitude (max.)	2000 m

Standards and specifications

Standards/Specifications	EN 61010-2-201; EN 61373; EN 50121-3-2
--------------------------	--

Subject to changes. Please also observe the further product documentation!

WAGO Kontakttechnik GmbH & Co. KG
 Hansastr. 27
 32423 Minden
 Phone: +49571 887-0 | Fax: +49571 887-169
 Email: info.de@wago.com | Web: www.wago.com

Do you have any questions about our products?
 We are always happy to take your call at +49 (571) 887-44222.

Commercial data

Packaging type	BOX
Country of origin	DE
GTIN	4055143651936
Customs tariff number	85364900990







Approvals / Certificates

UL-Approvals



Logo	Approval	Additional Approval Text	Certificate name
	UL Underwriters Laboratories Inc. (ORDINARY LOCATIONS)	UL 61010-1	E175199

Compatible products















End plate

	Item no.: 2002-1691 End and intermediate plate; 1 mm thick; gray	www.wago.com/2002-1691
	Item no.: 2002-1692 End and intermediate plate; 1 mm thick; orange	www.wago.com/2002-1692
	Item no.: 2002-1791 End and intermediate plate; 1 mm thick; gray	www.wago.com/2002-1791
	Item no.: 2002-1792 End and intermediate plate; 1 mm thick; orange	www.wago.com/2002-1792
	Item no.: 2002-1891 End and intermediate plate; 1 mm thick; gray	www.wago.com/2002-1891
	Item no.: 2002-1892 End and intermediate plate; 1 mm thick; orange	www.wago.com/2002-1892













clamps

	Item no.: 2002-1661 2-conductor carrier terminal block; for DIN-rail 35 x 15 and 35 x 7.5; 2.5 mm ² ; Push-in CAGE CLAMP®; 2,50 mm ² ; gray	www.wago.com/2002-1661
	Item no.: 2002-1761 3-conductor carrier terminal block; for DIN-rail 35 x 15 and 35 x 7.5; 2.5 mm ² ; Push-in CAGE CLAMP®; 2,50 mm ² ; gray	www.wago.com/2002-1761
	Item no.: 2002-1861 4-conductor carrier terminal block; for DIN-rail 35 x 15 and 35 x 7.5; 2.5 mm ² ; Push-in CAGE CLAMP®; 2,50 mm ² ; gray	www.wago.com/2002-1861

Subject to changes. Please also observe the further product documentation!

	Item no.: 2002-1961 2-conductor carrier terminal block; with additional jumper position; for DIN-rail 35 x 15 and 35 x 7.5; 2.5 mm ² ; Push-in CAGE CLAMP®; 2,50 mm ² ; gray	www.wago.com/2002-1961
Marking accessories		
	Item no.: 2009-110 Marking strips; for Smart Printer; on reel; not stretchable; plain; snap-on type; white	www.wago.com/2009-110
	Item no.: 2009-115 WMB-Inline; for Smart Printer; 1500 pieces on roll; stretchable 5 - 5.2 mm; plain; snap-on type; white	www.wago.com/2009-115
	Item no.: 2009-115/000-002 WMB-Inline; for Smart Printer; 1500 pieces on roll; stretchable 5 - 5.2 mm; plain; snap-on type; yellow	www.wago.com/2009-115/000-002
	Item no.: 2009-115/000-006 WMB-Inline; for Smart Printer; 1500 pieces on roll; stretchable 5 - 5.2 mm; plain; snap-on type; blue	www.wago.com/2009-115/000-006
	Item no.: 2009-115/000-007 WMB-Inline; for Smart Printer; 1500 pieces on roll; stretchable 5 - 5.2 mm; plain; snap-on type; gray	www.wago.com/2009-115/000-007
	Item no.: 2009-115/000-012 WMB-Inline; for Smart Printer; 1500 pieces on roll; stretchable 5 - 5.2 mm; plain; snap-on type; orange	www.wago.com/2009-115/000-012
	Item no.: 2009-115/000-017 WMB-Inline; for Smart Printer; 1500 pieces on roll; stretchable 5 - 5.2 mm; plain; snap-on type; light green	www.wago.com/2009-115/000-017
	Item no.: 2009-115/000-023 WMB-Inline; for Smart Printer; 1500 pieces on roll; stretchable 5 - 5.2 mm; plain; snap-on type; green	www.wago.com/2009-115/000-023
	Item no.: 2009-115/000-024 WMB-Inline; for Smart Printer; 1500 pieces on roll; stretchable 5 - 5.2 mm; plain; snap-on type; violet	www.wago.com/2009-115/000-024
	Item no.: 793-501 WMB marking card; as card; not stretchable; plain; snap-on type; white	www.wago.com/793-501
	Item no.: 793-501/000-002 WMB marking card; as card; not stretchable; plain; snap-on type; yellow	www.wago.com/793-501/000-002
	Item no.: 793-501/000-005 WMB marking card; as card; not stretchable; plain; snap-on type; red	www.wago.com/793-501/000-005
	Item no.: 793-501/000-006 WMB marking card; as card; not stretchable; plain; snap-on type; blue	www.wago.com/793-501/000-006

Subject to changes. Please also observe the further product documentation!

	Item no.: 793-501/000-007 WMB marking card; as card; not stretchable; plain; snap-on type; gray	www.wago.com/793-501/000-007
	Item no.: 793-501/000-012 WMB marking card; as card; not stretchable; plain; snap-on type; orange	www.wago.com/793-501/000-012
	Item no.: 793-501/000-017 WMB marking card; as card; not stretchable; plain; snap-on type; light green	www.wago.com/793-501/000-017
	Item no.: 793-501/000-023 WMB marking card; as card; not stretchable; plain; snap-on type; green	www.wago.com/793-501/000-023
	Item no.: 793-501/000-024 WMB marking card; as card; not stretchable; plain; snap-on type; violet	www.wago.com/793-501/000-024
	Item no.: 793-5501 WMB marking card; as card; for terminal block width 5 - 17.5 mm; stretchable 5 - 5.2 mm; plain; snap-on type; white	www.wago.com/793-5501
	Item no.: 793-5501/000-002 WMB marking card; as card; for terminal block width 5 - 17.5 mm; stretchable 5 - 5.2 mm; plain; snap-on type; yellow	www.wago.com/793-5501/000-002
	Item no.: 793-5501/000-005 WMB marking card; as card; for terminal block width 5 - 17.5 mm; stretchable 5 - 5.2 mm; plain; snap-on type; red	www.wago.com/793-5501/000-005
	Item no.: 793-5501/000-006 WMB marking card; as card; for terminal block width 5 - 17.5 mm; stretchable 5 - 5.2 mm; plain; snap-on type; blue	www.wago.com/793-5501/000-006
	Item no.: 793-5501/000-007 WMB marking card; as card; for terminal block width 5 - 17.5 mm; stretchable 5 - 5.2 mm; plain; snap-on type; gray	www.wago.com/793-5501/000-007
	Item no.: 793-5501/000-012 WMB marking card; as card; for terminal block width 5 - 17.5 mm; stretchable 5 - 5.2 mm; plain; snap-on type; orange	www.wago.com/793-5501/000-012
	Item no.: 793-5501/000-014 WMB marking card; as card; for terminal block width 5 - 17.5 mm; stretchable 5 - 5.2 mm; plain; snap-on type; brown	www.wago.com/793-5501/000-014
	Item no.: 793-5501/000-017 WMB marking card; as card; for terminal block width 5 - 17.5 mm; stretchable 5 - 5.2 mm; plain; snap-on type; green	www.wago.com/793-5501/000-017
	Item no.: 793-5501/000-023	

Subject to changes. Please also observe the further product documentation!

	WMB marking card; as card; for terminal block width 5 - 17.5 mm; stretchable 5 - 5.2 mm; plain; snap-on type; light green	www.wago.com/793-5501/000-023
---	---	--

	Item no.: 793-5501/000-024 WMB marking card; as card; for terminal block width 5 - 17.5 mm; stretchable 5 - 5.2 mm; plain; snap-on type; violet	www.wago.com/793-5501/000-024
---	---	--

**Downloads
Documentation**

Bid Text

2042-3829 X81 - Datei	2019 Feb 19	xml 3.9 kB	Download
2042-3829 docx - Datei	2019 Feb 20	docx 17.3 kB	Download

Instruction Leaflet

Pluggable Relay Module / Pluggable Solid-State Relay Module	V 1.1.0	pdf 2.0 MB	Download
---	---------	---------------	----------

Additional Information

Disposal; Electrical and electronic equipment, Packaging	V 1.0.0	pdf 265.8 kB	Download
--	---------	-----------------	----------

CAD/CAE-Data

CAD data

2D/3D Models 2042-3829	URL	Download
------------------------	-----	----------

CAE data

ZUKEN Portal 2042-3829	URL	Download
------------------------	-----	----------

Environmental Product Compliance

Compliance Search

Environmental Product Compliance 2042-3829	URL	Download
--	-----	----------

Subject to changes. Please also observe the further product documentation!

Data sheet | Item number: 2042-3829

www.wago.com/2042-3829



Relay module; Nominal input voltage: 24 ... 230 V AC/DC; 4 make contacts; Limiting continuous current: 3 A; Green status indicator; Module width: 25 mm

Installation Notes

Subject to changes. Please also observe the further product documentation!

WAGO Kontakttechnik GmbH & Co. KG
Hansastr. 27
32423 Minden
Phone: +49571 887-0 | Fax: +49571 887-169
Email: info.de@wago.com | Web: www.wago.com

Do you have any questions about our products?
We are always happy to take your call at +49 (571) 887-44222.