

Aluminum Electrolytic Capacitors Axial High Temperature, High Ripple Current

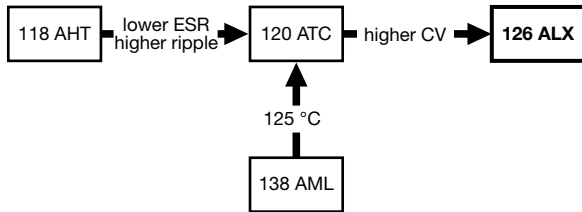

Fig. 1



FEATURES

- Extra long useful life: up to 8000 h at 125 °C
- Low ESR levels provide very high ripple current capability
- Miniaturized, high CV-product per unit volume
- Polarized aluminum electrolytic capacitors, non-solid electrolyte
- Axial leads, cylindrical aluminum case, insulated with a blue sleeve
- Taped versions up to case Ø 15 mm x 30 mm available for automatic insertion
- AEC-Q200 qualified
- Material categorization: for definitions of compliance please see www.vishay.com/doc?99912

APPLICATIONS

- Automotive, industrial, and telecommunication
- Smoothing, filtering, buffering
- Low mounting height applications, vibration and shock resistant
- SMPS and standard power supplies

MARKING

The capacitors are marked (where possible) with the following information:

- Rated capacitance (in µF)
- Tolerance on rated capacitance, code letter in accordance with IEC 60062 (M for ± 20 %)
- Rated voltage (in V)
- Upper category temperature (125 °C)
- Date code in accordance with IEC 60062
- Code for factory of origin
- Name of manufacturer
- Negative terminal identification
- Series number (126)

QUICK REFERENCE DATA	
DESCRIPTION	VALUE
Nominal case sizes (Ø D x L in mm)	6.5 x 18 to 10 x 25 10 x 30 to 21 x 38
Rated capacitance range, C _R	33 µF to 12 000 µF
Tolerance on C _R	± 20 %
Rated voltage range, U _R	10 V to 63 V
Category temperature range	-40 °C to +125 °C
Endurance test at 125 °C	2000 h 3000 h
Useful life at 125 °C	4000 h 8000 h
Useful life at 85 °C, 1.4 x I _R applied	40 000 h
Shelf life at 0 V, 125 °C	1000 h
Based on sectional specification	IEC 60384-4 / EN 130300
Climatic category IEC 60068	40 / 125 / 56

SELECTION CHART FOR C _R , U _R , AND RELEVANT NOMINAL CASE SIZE (Ø D x L in mm)					
C _R (µF)	U _R (V)				
	10	16	25	40	63
33	→	→	→	→	6.5 x 18
56	→	→	→	→	8 x 18
68	→	→	→	6.5 x 18	-
120	→	→	→	8 x 18	10 x 25
150	→	→	6.5 x 18	10 x 18	10 x 30
180	→	6.5 x 18	-	-	-
220	→	→	8 x 18	10 x 25	-
270	→	→	10 x 18	-	-
330	→	8 x 18	→	10 x 30	12.5 x 30
470	6.5 x 18	10 x 18	→	→	15 x 30
560	→	→	10 x 25	12.5 x 30	-
680	8 x 18	10 x 25	10 x 30	→	18 x 30

SELECTION CHART FOR C_R, U_R, AND RELEVANT NOMINAL CASE SIZE ($\varnothing D \times L$ in mm)					
C_R (μF)	U_R (V)				
	10	16	25	40	63
820	→	→	→	15 x 30	-
1000	10 x 18	10 x 30	→	→	18 x 38
1200	→	→	12.5 x 30	18 x 30	21 x 38
1500	10 x 30	-	-	-	-
1800	→	→	15 x 30	18 x 38	-
2200	→	12.5 x 30	-	-	-
2700	12.5 x 30	15 x 30	18 x 30	21 x 38	-
3900	15 x 30	→	18 x 38	-	-
4700	→	18 x 30	-	-	-
5600	→	→	21 x 38	-	-
6800	18 x 30	18 x 38	-	-	-
8200	→	21 x 38	-	-	-
10 000	18 x 38	-	-	-	-
12 000	21 x 38	-	-	-	-

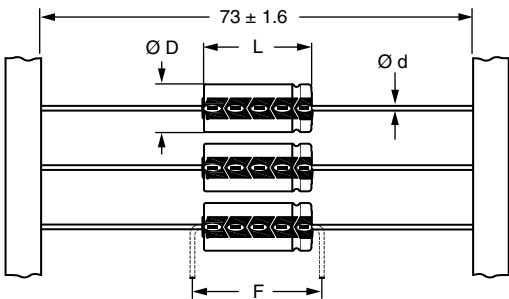
DIMENSIONS in millimeters AND AVAILABLE FORMS

Form BA: taped in box (ammopack)
Case $\varnothing D \times L = 6.5 \text{ mm} \times 18 \text{ mm}$ to $10 \text{ mm} \times 25 \text{ mm}$
Form BR: taped on reel
Case $\varnothing D \times L = 6.5 \text{ mm} \times 18 \text{ mm}$ to $15 \text{ mm} \times 30 \text{ mm}$

Fig. 2 - Form BA and BR

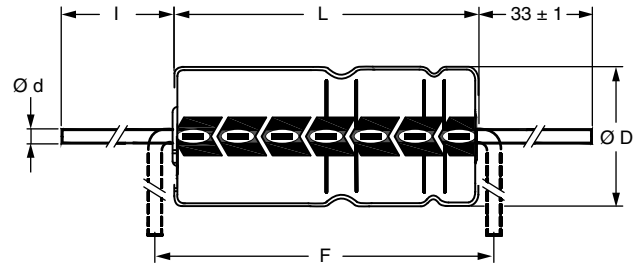

Form AA: Axial in box
Case $\varnothing D \times L = 10 \text{ mm} \times 30 \text{ mm}$ to $21 \text{ mm} \times 38 \text{ mm}$

Fig. 3 - Form AA

Table 1

AXIAL; DIMENSIONS in millimeters, MASS, AND PACKAGING QUANTITIES										
NOMINAL CASE SIZE $\varnothing D \times L$ (mm)	CASE CODE	AXIAL: FORM AA, BA, AND BR					MASS (g)	PACKAGING QUANTITIES		
		$\varnothing d$	l	$\varnothing D_{max}$	L_{max}	F_{min}		FORM AA	FORM BA	FORM BR
6.5 x 18	4	0.8	-	6.9	18.5	25	1.3	-	1000	1000
8 x 18	5	0.8	-	8.5	18.5	25	1.7	-	500	500
10 x 18	6	0.8	-	10.5	18.5	25	2.5	-	500	500
10 x 25	7	0.8	-	10.5	25.5	30	3.3	-	500	500
10 x 30	00	0.8	55 ± 1	10.5	30.5	35	4.8	340	-	500
12.5 x 30	01	0.8	55 ± 1	13.0	30.5	35	7.4	260	-	400
15 x 30	02	0.8	55 ± 1	15.5	30.5	35	11.7	200	-	250
18 x 30	03	0.8	55 ± 1	18.5	30.5	35	12.9	120	-	-
18 x 38	04	0.8	34 ± 1	18.5	39.5	44	19	125	-	-
21 x 38	05	0.8	34 ± 1	21.5	39.5	44	24	100	-	-

Note

- For detailed tape dimensions, please see www.vishay.com/doc?28361

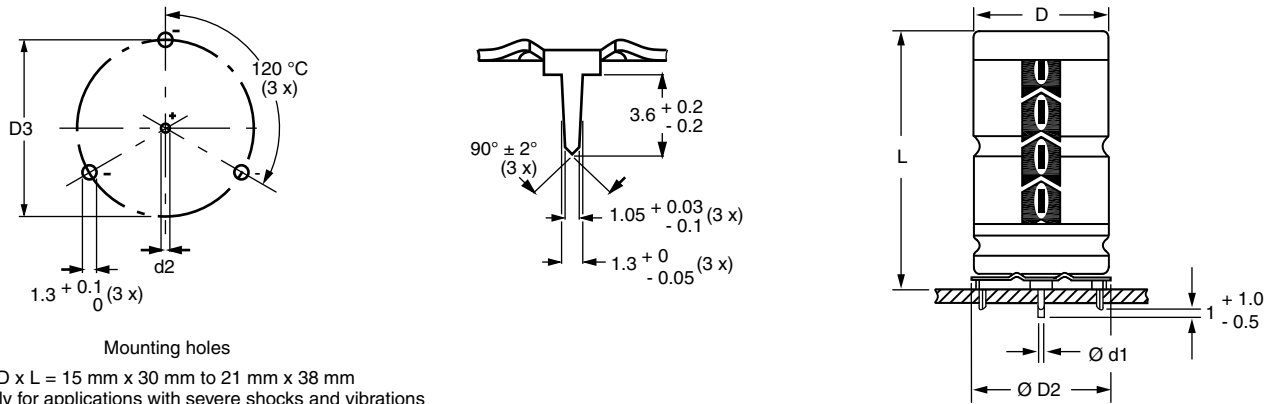

 Fig. 4 - Mounting hole diagram and outline; **form MR:** With mounting ring and pins

Table 2

MOUNTING RING; DIMENSIONS in millimeters, MASS, AND PACKAGING QUANTITIES									
NOMINAL CASE SIZE $\varnothing D \times L$	CASE CODE	MOUNTING RING: FORM MR						MASS (g)	PACKAGING QUANTITIES
		$\varnothing d1$	$\varnothing d2$	$\varnothing D_{max.}$	$\varnothing D2_{max.}$	D3	$L_{max.}$		
15 x 30	02	0.8	1.0 + 0.4	15.5	17.5	16.5 ± 0.2	33	≈ 8.6	200
18 x 30	03	0.8	1.0 + 0.4	18.5	19.5	18.5 ± 0.2	33	≈ 11.5	240
18 x 38	04	0.8	1.0 + 0.4	18.5	19.5	18.5 ± 0.2	42	≈ 14.0	100
21 x 38	05	0.8	1.0 + 0.4	21.5	22.5	21.5 ± 0.2	42	≈ 19.2	100

ELECTRICAL DATA	
SYMBOL	DESCRIPTION
C_R	Rated capacitance at 100 Hz, tolerance ± 20 %
I_R	Rated RMS ripple current at 10 kHz, 125 °C
I_{L1}	Max. leakage current after 1 min at U_R
I_{L5}	Max. leakage current after 5 min at U_R
ESR	Equivalent series resistance at 100 Hz (calculated from $\tan \delta_{max.}$ and C_R)
Z	Max. impedance at 10 kHz

Note

- Unless otherwise specified, all electrical values in Table 3 apply at $T_{amb} = 20 \text{ °C}$, $P = 86 \text{ kPa}$ to 106 kPa , $RH = 45 \text{ %}$ to 75 % .

ORDERING EXAMPLE

Electrolytic capacitor 126 series

 1000 μF / 16 V; ± 20 %

 Nominal case size: $\varnothing 10 \text{ mm} \times 30 \text{ mm}$; form BR

Ordering code: MAL212625102E3



Table 3

ELECTRICAL DATA AND ORDERING INFORMATION													
U _R (V)	C _R 100 Hz (μF)	NOMINAL CASE SIZE Ø D x L (mm)	I _R 100 Hz 125 °C (mA)	I _{L1} 1 min (μA)	I _{L5} 5 min (μA)	tan δ 100 Hz	MAX. ESR 100 Hz (Ω)	MAX. ESR 10 kHz (Ω)	Z MAX. 10 kHz (Ω)	ORDERING CODE MAL2126.....			
										IN BOX FORM AA	TAPED ON REEL FORM BR	TAPED IN BOX FORM BA	MOUNTING RING FORM MR
10	470	6.5 x 18	190	96	59	0.30	1.016	0.991	2.100	-	24471E3	34471E3	-
	680	8 x 18	300	122	67	0.30	0.702	0.579	1.000	-	24681E3	34681E3	-
	1000	10 x 18	520	160	80	0.32	0.509	0.382	0.750	-	24102E3	34102E3	-
	1500	10 x 30	670	220	100	0.32	0.224	0.091	0.078	14152E3	24152E3	-	-
	2700	12.5 x 30	890	364	148	0.34	0.132	0.070	0.061	14272E3	24272E3	-	-
	3900	15 x 30	1140	508	196	0.36	0.097	0.055	0.046	14392E3	24392E3	-	44392E3
	6800	18 x 30	1450	856	312	0.42	0.065	0.037	0.043	14682E3	-	-	44682E3
	10 000	18 x 38	1880	1240	440	0.50	0.053	0.032	0.029	14103E3	-	-	44103E3
	12 000	21 x 38	2200	1480	520	0.54	0.047	0.029	0.029	14123E3	-	-	44123E3
16	180	6.5 x 18	180	75	52	0.20	1.768	1.121	2.500	-	25181E3	35181E3	-
	330	8 x 18	230	103	61	0.20	0.965	0.517	1.500	-	25331E3	35331E3	-
	470	10 x 18	330	130	70	0.20	0.677	0.330	0.830	-	25471E3	35471E3	-
	680	10 x 25	490	171	84	0.20	0.468	0.228	0.550	-	25681E3	35681E3	-
	1000	10 x 30	630	232	104	0.22	0.231	0.090	0.108	15102E3	25102E3	-	-
	2200	12.5 x 30	860	462	181	0.24	0.115	0.058	0.061	15222E3	25222E3	-	-
	2700	15 x 30	1090	558	213	0.24	0.093	0.051	0.046	15272E3	25272E3	-	45272E3
	4700	18 x 30	1480	942	341	0.28	0.063	0.034	0.043	15472E3	-	-	45472E3
	6800	18 x 38	1930	1346	475	0.32	0.049	0.029	0.035	15682E3	-	-	45682E3
8200	21 x 38	2100	1614	565	0.36	0.046	0.027	0.029	15822E3	-	-	45822E3	
25	150	6.5 x 18	160	85	55	0.18	1.910	1.162	2.300	-	26151E3	36151E3	-
	220	8 x 18	210	106	62	0.18	1.302	0.670	0.910	-	26221E3	36221E3	-
	270	10 x 18	270	121	67	0.18	1.061	0.497	1.250	-	26271E3	36271E3	-
	560	10 x 25	440	208	96	0.18	0.512	0.239	0.570	-	26561E3	36561E3	-
	680	10 x 30	580	244	108	0.18	0.278	0.099	0.119	16681E3	26681E3	-	-
	1200	12.5 x 30	790	400	160	0.20	0.175	0.050	0.061	16122E3	26122E3	-	-
	1800	15 x 30	1020	580	220	0.20	0.117	0.041	0.046	16182E3	26182E3	-	46182E3
	2700	18 x 30	1320	850	310	0.24	0.093	0.033	0.043	16272E3	-	-	46272E3
	3900	18 x 38	1840	1210	430	0.26	0.070	0.030	0.036	16392E3	-	-	46392E3
5600	21 x 38	2100	1720	600	0.30	0.056	0.024	0.029	16562E3	-	-	46562E3	
40	68	6.5 x 18	120	73	51	0.11	2.575	1.566	2.800	-	27689E3	37689E3	-
	120	8 x 18	180	98	59	0.11	1.459	0.751	1.300	-	27121E3	37121E3	-
	150	10 x 18	250	112	64	0.11	1.167	0.546	1.000	-	27151E3	37151E3	-
	220	10 x 25	350	146	75	0.11	0.786	0.372	0.680	-	27221E3	37221E3	-
	330	10 x 30	490	198	93	0.11	0.350	0.125	0.150	17331E3	27331E3	-	-
	560	12.5 x 30	750	309	130	0.11	0.206	0.081	0.097	17561E3	27561E3	-	-
	820	15 x 30	970	434	171	0.11	0.141	0.050	0.055	17821E3	27821E3	-	47821E3
	1200	18 x 30	1250	616	232	0.13	0.114	0.041	0.049	17122E3	-	-	47122E3
	1800	18 x 38	1640	904	328	0.13	0.076	0.036	0.043	17182E3	-	-	47182E3
2700	21 x 38	1810	1336	472	0.15	0.058	0.027	0.031	17272E3	-	-	47272E3	



ELECTRICAL DATA AND ORDERING INFORMATION													
U _R (V)	C _R 100 Hz (μF)	NOMINAL CASE SIZE Ø D x L (mm)	I _R 100 Hz 125 °C (mA)	I _{L1} 1 min (μA)	I _{L5} 5 min (μA)	tan δ 100 Hz	MAX. ESR 100 Hz (Ω)	MAX. ESR 10 kHz (Ω)	Z MAX. 10 kHz (Ω)	ORDERING CODE MAL2126.....			
										IN BOX FORM AA	TAPED ON REEL FORM BR	TAPED IN BOX FORM BA	MOUNTING RING FORM MR
63	33	6.5 x 18	100	65	48	0.08	3.858	2.347	5.600	-	28339E3	38339E3	-
	56	8 x 18	150	82	54	0.08	2.274	1.171	1.500	-	28569E3	38569E3	-
	120	10 x 25	280	131	70	0.08	1.061	0.497	0.700	-	28121E3	38121E3	-
	180	10 x 30	410	176	85	0.08	0.467	0.121	0.249	18181E3	28181E3	-	-
	330	12.5 x 30	660	289	123	0.08	0.255	0.099	0.126	18331E3	28331E3	-	-
	470	15 x 30	860	395	158	0.08	0.179	0.070	0.091	18471E3	28471E3	-	48471E3
	680	18 x 30	1130	554	211	0.08	0.124	0.048	0.074	18681E3	-	-	48681E3
	1000	18 x 38	1460	796	292	0.10	0.105	0.041	0.049	18102E3	-	-	48102E3
	1200	21 x 38	1680	947	342	0.12	0.105	0.041	0.043	18122E3	-	-	48122E3

ADDITIONAL ELECTRICAL DATA			
PARAMETER	CONDITIONS	VALUE	
		AXIAL	MOUNTING RING
Voltage			
Surge voltage		U _s ≤ 1.15 x U _R	
Reverse voltage		U _{rev} ≤ 1 V	
Current			
Leakage current	After 1 min at U _R	I _{L1} ≤ 0.012 C _R x U _R + 40 μA	
	After 5 min at U _R	I _{L5} ≤ 0.004 C _R x U _R + 40 μA	
Inductance			
Equivalent series inductance (ESL)	Case Ø D x L mm:		
	6.5 x 18	Typ. 15 nH	
	8 x 18	Typ. 35 nH	
	10 x 18	Typ. 69 nH	
	10 x 25, 10 x 30	Typ. 38 nH	
	12.5 x 30	Typ. 46 nH	
	15 x 30	Typ. 48 nH	Typ. 39 nH
	18 x 30	Typ. 50 nH	Typ. 39 nH
	18 x 38	Typ. 54 nH	Typ. 39 nH
21 x 38	Typ. 59 nH	Typ. 39 nH	

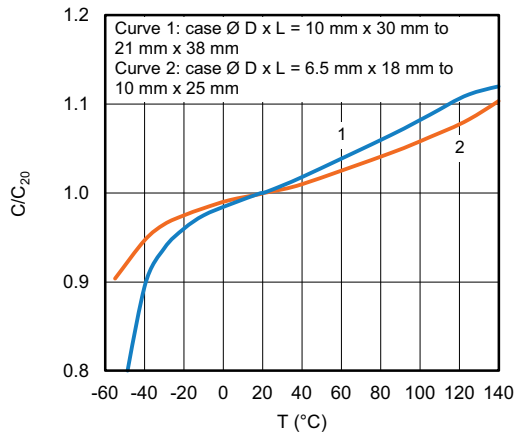
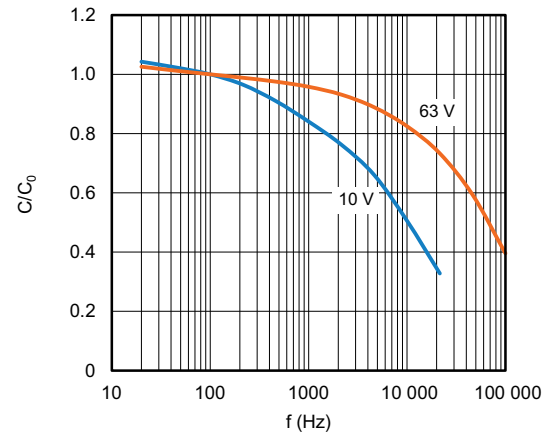
CAPACITANCE (C)

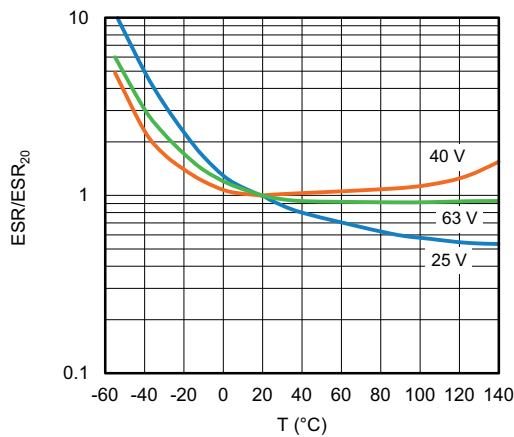
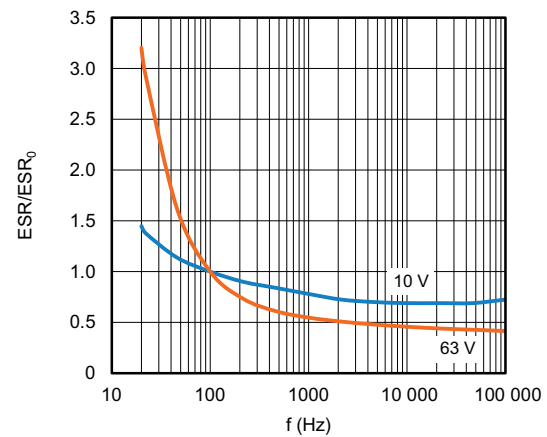
 Fig. 5 - Typical multiplier of capacitance as a function of ambient temperature (C_{20} = capacitance at 20 °C, 100 Hz)

 Fig. 6 - Typical multiplier of capacitance as a function of frequency (C_0 = typical capacitance at 100 Hz at 20 °C)

EQUIVALENT SERIES RESISTANCE (ESR)

 Fig. 7 - Typical multiplier of ESR as a function of ambient temperature (ESR_{20} = typical ESR at 100 Hz at 20 °C)

 Fig. 8 - Typical multiplier of ESR as a function of frequency (ESR_0 = typical ESR at 100 Hz at 20 °C)

RIPPLE CURRENT AND USEFUL LIFE

Table 4

ENDURANCE TEST DURATION AND USEFUL LIFE		
NOMINAL CASE SIZE Ø D x L (mm)	ENDURANCE AT 125 °C (h)	USEFUL LIFE AT 125 °C (h)
6.5 x 18	2000	4000
8 x 18	2000	4000
10 x 18	2000	4000
10 x 25	2000	4000
10 x 30	3000	8000
12.5 x 30	3000	8000
15 x 30	3000	8000
18 x 30	3000	8000
18 x 38	3000	8000
21 x 38	3000	8000

Note

- Multiplier of useful life code: MBC242

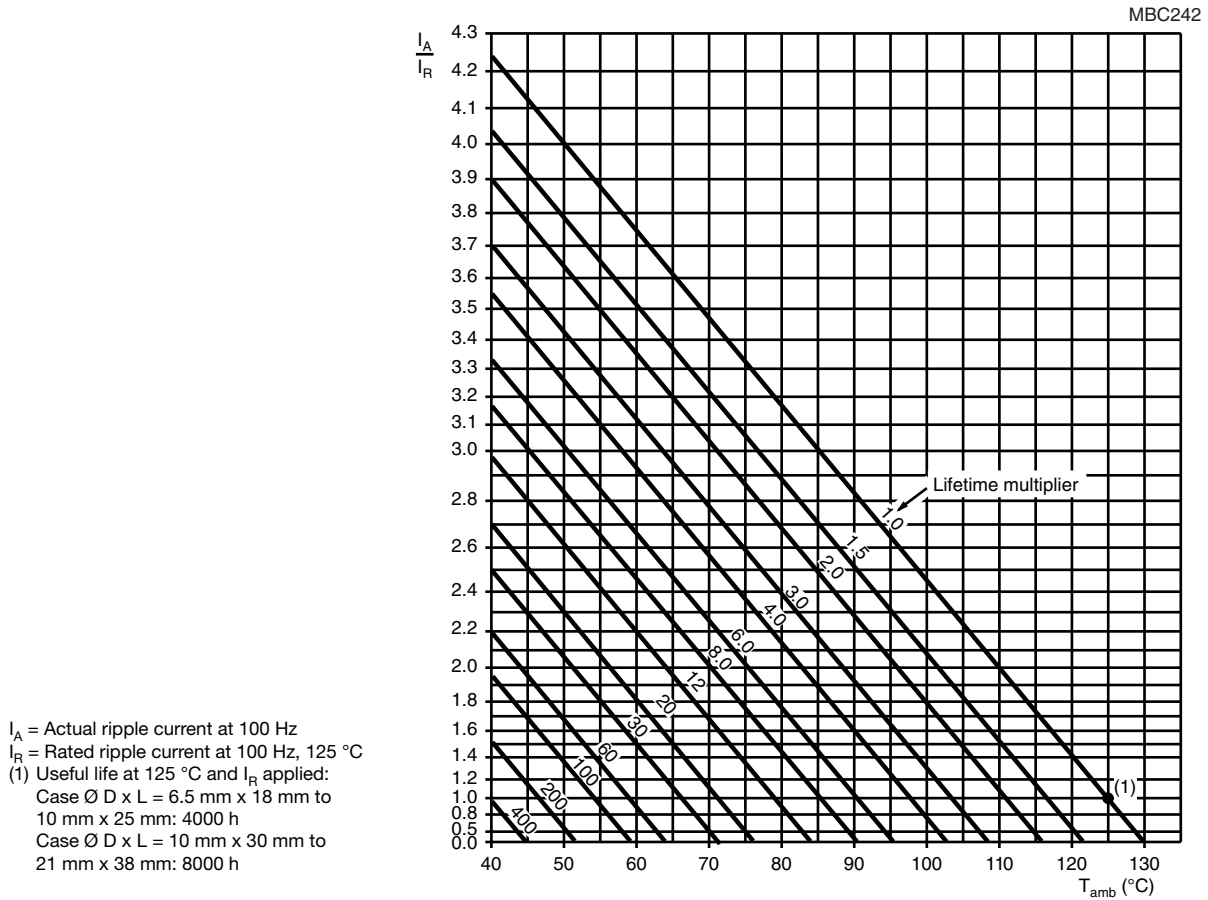

Fig. 9 - Multiplier of useful life as a function of ambient temperature and ripple current load

Table 5

MULTIPLIER OF RIPPLE CURRENT (I_R) AS A FUNCTION OF FREQUENCY						
U_R (V)	FREQUENCY (Hz)					
	50	100	300	1000	3000	$\geq 10\ 000$
	I_R MULTIPLIER					
10	0.95	1.00	1.07	1.12	1.15	1.20
16	0.95	1.00	1.07	1.12	1.15	1.20
25	0.95	1.00	1.07	1.12	1.15	1.20
40	0.90	1.00	1.12	1.20	1.25	1.30
63	0.90	1.00	1.12	1.20	1.25	1.30

Table 6

TEST PROCEDURES AND REQUIREMENTS			
TEST		PROCEDURE (quick reference)	REQUIREMENTS
NAME OF TEST	REFERENCE		
Endurance	IEC 60384-4 / EN 130300 subclause 4.13	$T_{amb} = 125\text{ }^{\circ}\text{C}$; U_R applied; Case sizes: 6.5 mm x 18 mm to 10 mm x 25 mm: 2000 h; 10 mm x 30 mm to 21 mm x 38 mm: 3000 h	$U_R = 10\text{ V}$; $\Delta C/C: \pm 20\%$ $U_R > 10\text{ V}$; $\Delta C/C: \pm 15\%$ $\tan \delta \leq 1.3 \times \text{spec. limit}$ $Z \leq 2 \times \text{spec. limit}$ $I_{L5} \leq \text{spec. limit}$
Useful life	CECC 30301 subclause 1.8.1	$T_{amb} = 125\text{ }^{\circ}\text{C}$; U_R and I_R applied; Case $\emptyset D \times L = 6.5\text{ mm} \times 18\text{ mm}$ to $10\text{ mm} \times 25\text{ mm}$: 4000 h Case $\emptyset D \times L = 10\text{ mm} \times 30\text{ mm}$ to $21\text{ mm} \times 38\text{ mm}$: 8000 h	$U_R > 10\text{ V}$; $\Delta C/C: \pm 45\%$ $\tan \delta \leq 3 \times \text{spec. limit}$ $Z \leq 3 \times \text{spec. limit}$ $I_{L5} \leq \text{spec. limit}$ no short or open circuit total failure percentage: $\leq 1\%$
Shelf life (storage at high temperature)	IEC 60384-4 / EN 130300 subclause 4.17	$T_{amb} = 125\text{ }^{\circ}\text{C}$; no voltage applied; $U_R = 6.3\text{ V}$ to 63 V : 1000 h; After test: U_R to be applied for 30 min, 24 h to 48 h before measurement	$\Delta C/C$, $\tan \delta$, Z : for requirements see "Endurance test" above $I_{L5} \leq 2 \times \text{spec. limit}$
Reverse voltage	IEC 60384-4 / EN 130300 subclause 4.15	$T_{amb} = 125\text{ }^{\circ}\text{C}$: 125 h at $U = -1\text{ V}$ followed by 125 h at U_R	$\Delta C/C: \pm 20\%$ $\tan \delta \leq \text{spec. limit}$ $I_{L5} \leq \text{spec. limit}$

Statements about product lifetime are based on calculations and internal testing. They should only be interpreted as estimations. Also due to external factors, the lifetime in the field application may deviate from the calculated lifetime. In general, nothing stated herein shall be construed as a guarantee of durability.



Disclaimer

ALL PRODUCT, PRODUCT SPECIFICATIONS AND DATA ARE SUBJECT TO CHANGE WITHOUT NOTICE TO IMPROVE RELIABILITY, FUNCTION OR DESIGN OR OTHERWISE.

Vishay Intertechnology, Inc., its affiliates, agents, and employees, and all persons acting on its or their behalf (collectively, "Vishay"), disclaim any and all liability for any errors, inaccuracies or incompleteness contained in any datasheet or in any other disclosure relating to any product.

Vishay makes no warranty, representation or guarantee regarding the suitability of the products for any particular purpose or the continuing production of any product. To the maximum extent permitted by applicable law, Vishay disclaims (i) any and all liability arising out of the application or use of any product, (ii) any and all liability, including without limitation special, consequential or incidental damages, and (iii) any and all implied warranties, including warranties of fitness for particular purpose, non-infringement and merchantability.

Statements regarding the suitability of products for certain types of applications are based on Vishay's knowledge of typical requirements that are often placed on Vishay products in generic applications. Such statements are not binding statements about the suitability of products for a particular application. It is the customer's responsibility to validate that a particular product with the properties described in the product specification is suitable for use in a particular application. Parameters provided in datasheets and / or specifications may vary in different applications and performance may vary over time. All operating parameters, including typical parameters, must be validated for each customer application by the customer's technical experts. Product specifications do not expand or otherwise modify Vishay's terms and conditions of purchase, including but not limited to the warranty expressed therein.

Hyperlinks included in this datasheet may direct users to third-party websites. These links are provided as a convenience and for informational purposes only. Inclusion of these hyperlinks does not constitute an endorsement or an approval by Vishay of any of the products, services or opinions of the corporation, organization or individual associated with the third-party website. Vishay disclaims any and all liability and bears no responsibility for the accuracy, legality or content of the third-party website or for that of subsequent links.

Except as expressly indicated in writing, Vishay products are not designed for use in medical, life-saving, or life-sustaining applications or for any other application in which the failure of the Vishay product could result in personal injury or death. Customers using or selling Vishay products not expressly indicated for use in such applications do so at their own risk. Please contact authorized Vishay personnel to obtain written terms and conditions regarding products designed for such applications.

No license, express or implied, by estoppel or otherwise, to any intellectual property rights is granted by this document or by any conduct of Vishay. Product names and markings noted herein may be trademarks of their respective owners.