

## Power MOSFET

TO-247AC

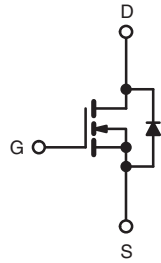
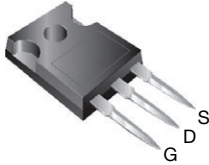

N-Channel MOSFET

### FEATURES

- Low gate charge  $Q_g$  results in simple drive requirement
- Improved gate, avalanche and dynamic  $dV/dt$  ruggedness
- Fully characterized capacitance and avalanche voltage and current
- Enhanced body diode  $dV/dt$  capability
- Material categorization: for definitions of compliance please see [www.vishay.com/doc?99912](http://www.vishay.com/doc?99912)

**RoHS\***  
Available

### Note

\* This datasheet provides information about parts that are RoHS-compliant and / or parts that are non RoHS-compliant. For example, parts with lead (Pb) terminations are not RoHS-compliant. Please see the information / tables in this datasheet for details

### APPLICATIONS

- Hard switching primary or PFC switch
- Switch mode power supply (SMPS)
- Uninterruptible power supply
- High speed power switching
- Motor drive

### PRODUCT SUMMARY

$V_{DS}$ (V)	600	
$R_{DS(on)}$ ( $\Omega$ )	$V_{GS} = 10\text{ V}$	0.18
$Q_g$ (max.) (nC)	180	
$Q_{gs}$ (nC)	56	
$Q_{gd}$ (nC)	86	
Configuration	Single	

### ORDERING INFORMATION

Package	TO-247AC
Lead (Pb)-free	IRFP27N60KPbF

### ABSOLUTE MAXIMUM RATINGS ( $T_C = 25\text{ }^\circ\text{C}$ , unless otherwise noted)

PARAMETER	SYMBOL	LIMIT	UNIT	
Drain-source voltage	$V_{DS}$	600	V	
Gate-source voltage	$V_{GS}$	$\pm 30$		
Continuous drain current	$V_{GS}$ at 10 V	$T_C = 25\text{ }^\circ\text{C}$	A	
		$T_C = 100\text{ }^\circ\text{C}$		
Pulsed drain Current <sup>a</sup>	$I_{DM}$	110		
Linear derating Factor		4.0	W/ $^\circ\text{C}$	
Single pulse avalanche energy <sup>b</sup>	$E_{AS}$	530	mJ	
Repetitive avalanche current <sup>a</sup>	$I_{AR}$	27	A	
Repetitive avalanche energy <sup>a</sup>	$E_{AR}$	50	mJ	
Maximum power dissipation	$T_C = 25\text{ }^\circ\text{C}$	$P_D$	W	
Peak diode recovery $dV/dt$ <sup>c</sup>	$dV/dt$	13	V/ns	
Operating junction and storage temperature range	$T_J, T_{stg}$	-55 to +150	$^\circ\text{C}$	
Soldering recommendations (peak temperature) <sup>d</sup>	for 10 s	300 <sup>d</sup>		
Mounting torque	6-32 or M3 screw		10	lbf · in
			1.1	N · m

### Notes

- Repetitive rating; pulse width limited by maximum junction temperature (see fig. 11)
- Starting  $T_J = 25\text{ }^\circ\text{C}$ ,  $L = 1.4\text{ mH}$ ,  $R_g = 25\text{ }\Omega$ ,  $I_{AS} = 27\text{ A}$ ,  $dV/dt = 13\text{ V/ns}$  (see fig. 12)
- $I_{SD} \leq 27\text{ A}$ ,  $dI/dt \leq 390\text{ A}/\mu\text{s}$ ,  $V_{DD} \leq V_{DS}$ ,  $T_J \leq 150\text{ }^\circ\text{C}$
- 1.6 mm from case



THERMAL RESISTANCE RATINGS				
PARAMETER	SYMBOL	TYP.	MAX.	UNIT
Maximum junction-to-ambient	$R_{thJA}$	-	40	°C/W
Case-to-sink, flat, greased surface	$R_{thCS}$	0.24	-	
Maximum junction-to-case (drain)	$R_{thJC}$	-	0.29	

SPECIFICATIONS ( $T_J = 25\text{ }^\circ\text{C}$ , unless otherwise noted)						
PARAMETER	SYMBOL	TEST CONDITIONS	MIN.	TYP.	MAX.	UNIT
<b>Static</b>						
Drain-source breakdown voltage	$V_{DS}$	$V_{GS} = 0\text{ V}, I_D = 250\text{ }\mu\text{A}$	600	-	-	V
$V_{DS}$ temperature coefficient	$\Delta V_{DS}/T_J$	Reference to $25\text{ }^\circ\text{C}, I_D = 1\text{ mA}$	-	640	-	mV/°C
Gate-source threshold voltage	$V_{GS(th)}$	$V_{DS} = V_{GS}, I_D = 250\text{ }\mu\text{A}$	3.0	-	5.0	V
Gate-source leakage	$I_{GSS}$	$V_{GS} = \pm 30\text{ V}$	-	-	$\pm 100$	nA
Zero gate voltage drain current	$I_{DSS}$	$V_{DS} = 600\text{ V}, V_{GS} = 0\text{ V}$	-	-	50	$\mu\text{A}$
		$V_{DS} = 480\text{ V}, V_{GS} = 0\text{ V}, T_J = 125\text{ }^\circ\text{C}$	-	-	250	
Drain-source on-state resistance	$R_{DS(on)}$	$V_{GS} = 10\text{ V}, I_D = 16\text{ A}^b$	-	0.18	0.22	$\Omega$
Forward transconductance	$g_{fs}$	$V_{DS} = 50\text{ V}, I_D = 16\text{ A}$	14	-	-	S
<b>Dynamic</b>						
Input capacitance	$C_{iss}$	$V_{GS} = 0\text{ V}, V_{DS} = 25\text{ V}, f = 1.0\text{ MHz}, \text{ see fig. 5}$	-	4660	-	pF
Output capacitance	$C_{oss}$		-	460	-	
Reverse transfer capacitance	$C_{rss}$		-	41	-	
Output capacitance	$C_{oss}$	$V_{GS} = 0\text{ V}, V_{DS} = 1.0\text{ V}, f = 1.0\text{ MHz}$	-	5490	-	pF
		$V_{GS} = 0\text{ V}, V_{DS} = 480\text{ V}, f = 1.0\text{ MHz}$	-	120	-	
Effective output capacitance	$C_{oss\text{ eff.}}$	$V_{GS} = 0\text{ V}, V_{DS} = 0\text{ V to } 480\text{ V}$	-	250	-	pF
Total gate charge	$Q_g$	$V_{GS} = 10\text{ V}, I_D = 27\text{ A}, V_{DS} = 480\text{ V}, \text{ see fig. 6 and 13}^b$	-	-	180	nC
Gate-source charge	$Q_{gs}$		-	-	56	
Gate-drain charge	$Q_{gd}$		-	-	86	
Turn-on delay time	$t_{d(on)}$	$V_{DD} = 300\text{ V}, I_D = 27\text{ A}, R_g = 4.3\text{ }\Omega, V_{GS} = 10\text{ V}, \text{ see fig. 10}^b$	-	27	-	ns
Rise time	$t_r$		-	110	-	
Turn-off delay time	$t_{d(off)}$		-	43	-	
Fall time	$t_f$		-	38	-	
<b>Drain-Source Body Diode Characteristics</b>						
Continuous source-drain diode current	$I_S$	MOSFET symbol showing the integral reverse p-n junction diode 	-	-	27	A
Pulsed diode forward current <sup>a</sup>	$I_{SM}$		-	-	110	
Body diode voltage	$V_{SD}$	$T_J = 25\text{ }^\circ\text{C}, I_S = 27\text{ A}, V_{GS} = 0\text{ V}^b$	-	-	1.5	V
Body diode reverse recovery time	$t_{rr}$	$T_J = 25\text{ }^\circ\text{C}, I_F = 27\text{ A}, dI/dt = 100\text{ A}/\mu\text{s}^b$	-	620	920	ns
Body diode reverse recovery charge	$Q_{rr}$		-	11	16	$\mu\text{C}$
Reverse recovery current	$I_{RRM}$		-	36	53	A
Forward turn-on time	$t_{on}$	Intrinsic turn-on time is negligible (turn-on is dominated by $L_S$ and $L_D$ )				

**Notes**

- a. Repetitive rating; pulse width limited by maximum junction temperature (see fig. 11)
- b. Pulse width  $\leq 300\text{ }\mu\text{s}$ ; duty cycle  $\leq 2\%$
- c.  $C_{oss\text{ eff.}}$  is a fixed capacitance that gives the same charging time as  $C_{oss}$  while  $V_{DS}$  is rising from 0 % to 80%  $V_{DS}$



## TYPICAL CHARACTERISTICS (25 °C, unless otherwise noted)

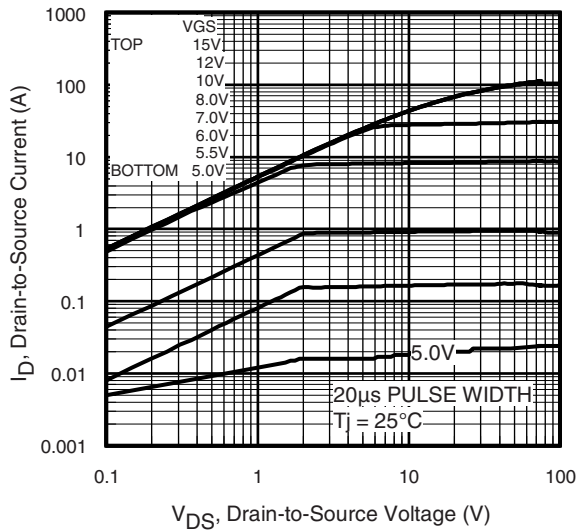

Fig. 1 - Typical Output Characteristics

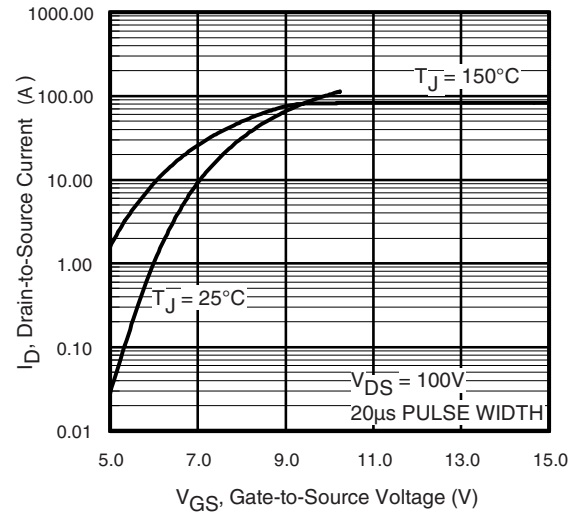

Fig. 3 - Typical Transfer Characteristics

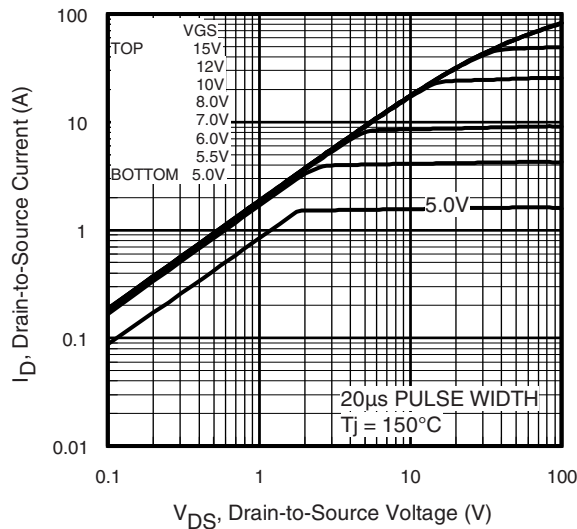

Fig. 2 - Typical Output Characteristics

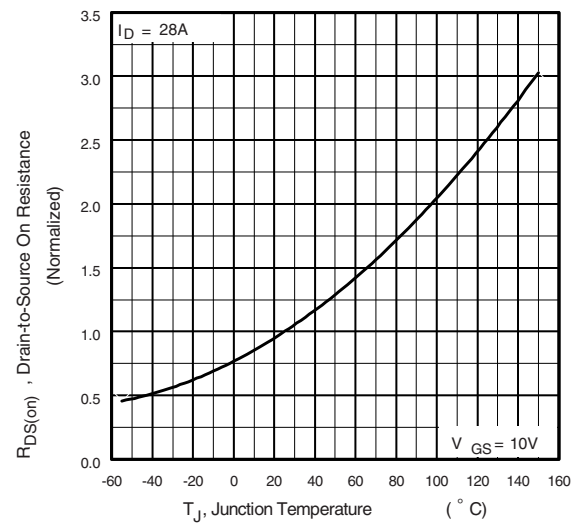

Fig. 4 - Normalized On-Resistance vs. Temperature

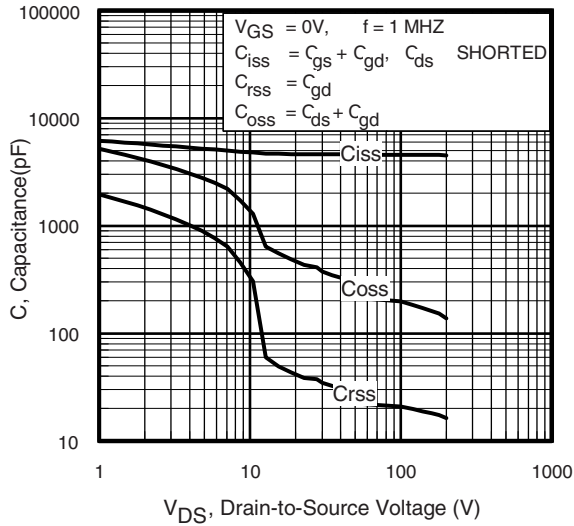

Fig. 5 - Typical Capacitance vs. Drain-to-Source Voltage

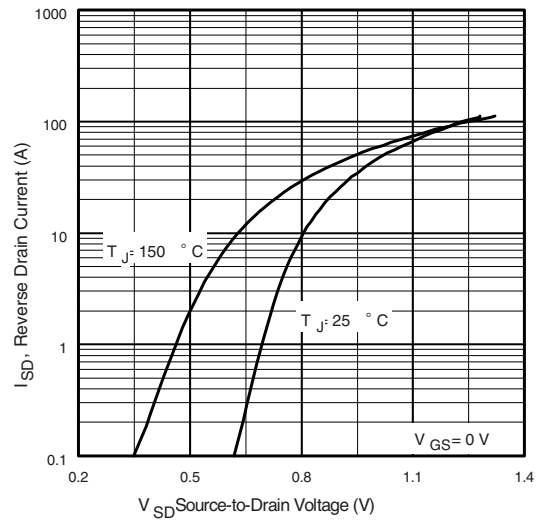

Fig. 7 - Typical Source-Drain Diode Forward Voltage

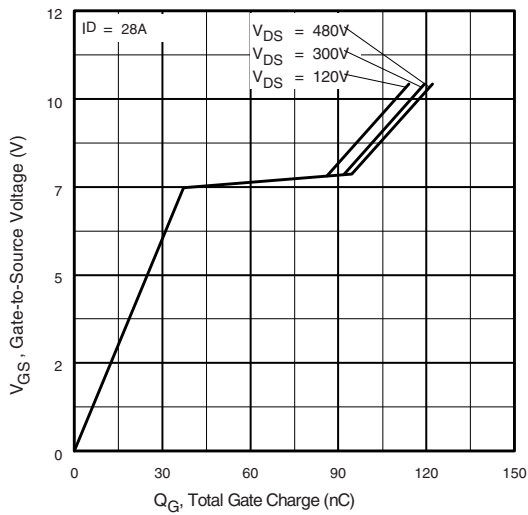

Fig. 6 - Typical Gate Charge vs. Gate-to-Source Voltage

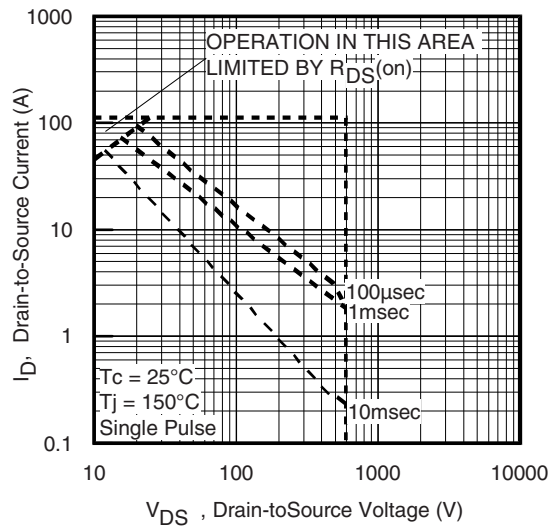

Fig. 8 - Maximum Safe Operating Area

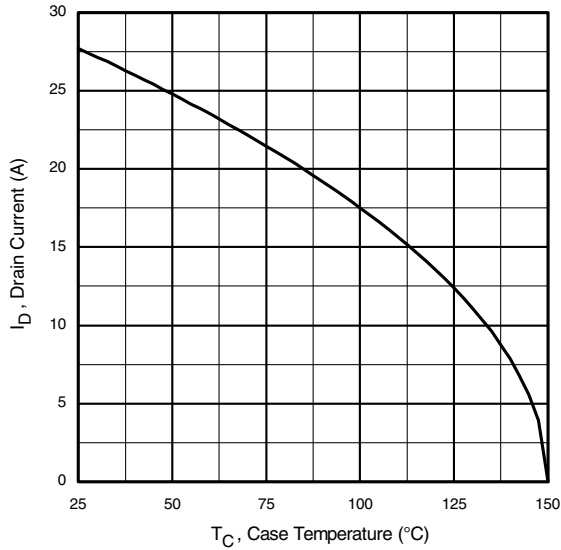

Fig. 9 - Maximum Drain Current vs. Case Temperature

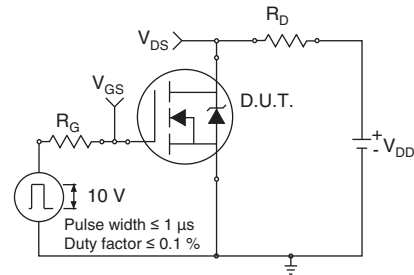

Fig. 10 - Switching Time Test Circuit

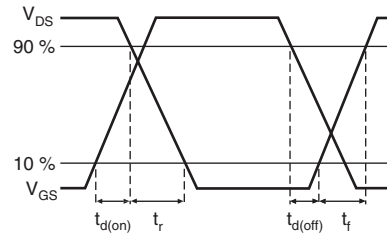

Fig. 11 - Switching Time Waveforms

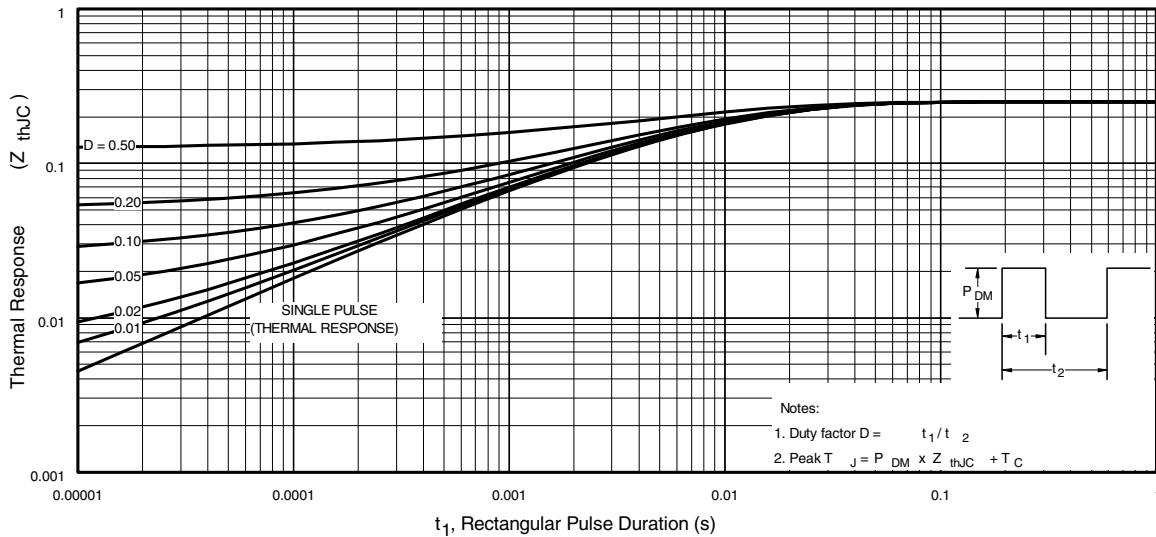

Fig. 12 - Maximum Effective Transient Thermal Impedance, Junction-to-Case

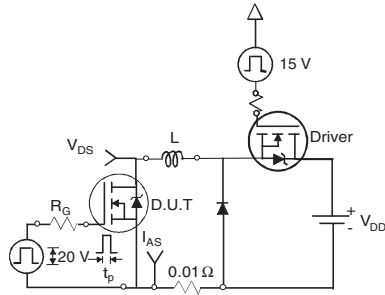

Fig. 13 - Unclamped Inductive Test Circuit

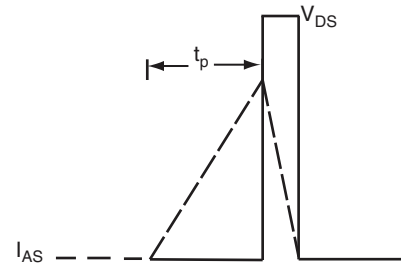

Fig. 14 - Unclamped Inductive Waveforms

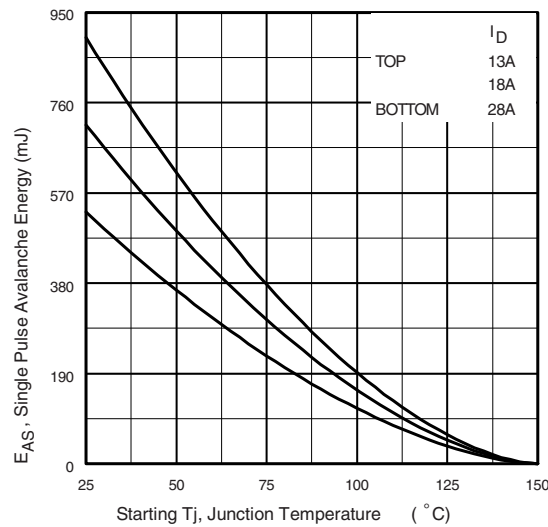

Fig. 15 - Maximum Avalanche Energy vs. Drain Current

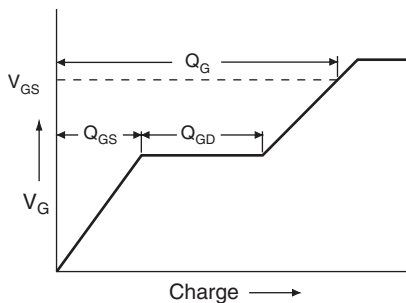

Fig. 16 - Basic Gate Charge Waveform

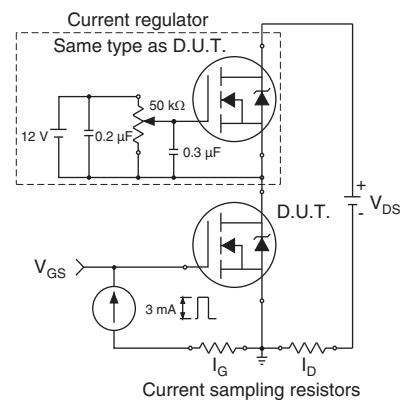
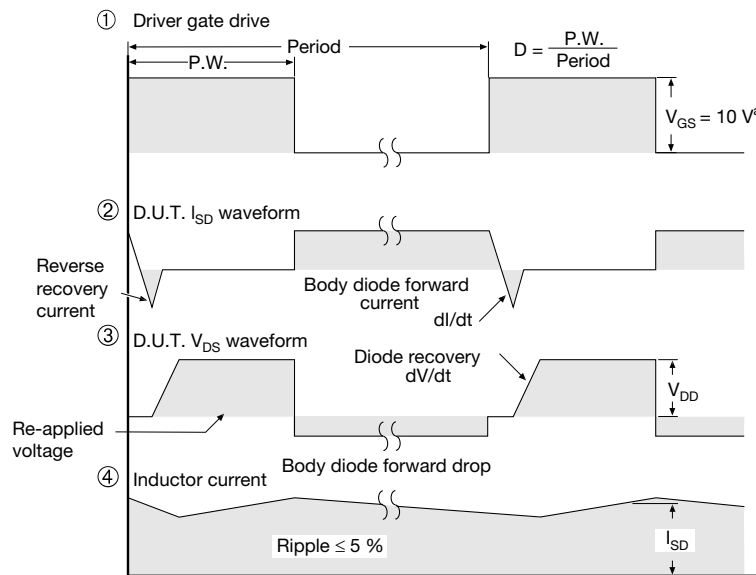
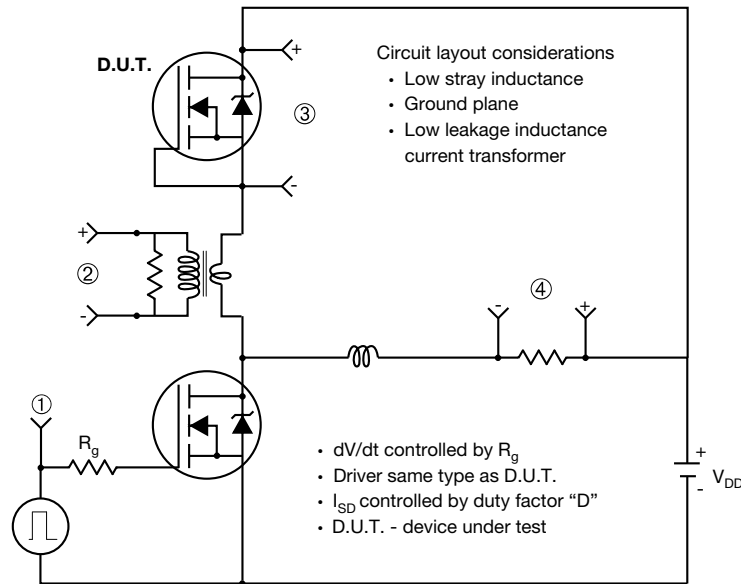

Fig. 17 - Gate Charge Test Circuit

### Peak Diode Recovery dV/dt Test Circuit



**Note**

a.  $V_{GS} = 5 V$  for logic level devices

**Fig. 18 - For N-Channel**

Vishay Siliconix maintains worldwide manufacturing capability. Products may be manufactured at one of several qualified locations. Reliability data for Silicon Technology and Package Reliability represent a composite of all qualified locations. For related documents such as package/tape drawings, part marking, and reliability data, see [www.vishay.com/ppg?91219](http://www.vishay.com/ppg?91219).



# TO-247AC (High Voltage)

VERSION 1: FACILITY CODE = 9



Section C--C, D--D, E--E

DIM.	MILLIMETERS		NOTES
	MIN.	MAX.	
A	4.83	5.21	
A1	2.29	2.55	
A2	1.50	2.49	
b	1.12	1.33	
b1	1.12	1.28	
b2	1.91	2.39	6
b3	1.91	2.34	
b4	2.87	3.22	6, 8
b5	2.87	3.18	
c	0.55	0.69	6
c1	0.55	0.65	
D	20.40	20.70	4

DIM.	MILLIMETERS		NOTES
	MIN.	MAX.	
D1	16.25	16.85	5
D2	0.56	0.76	
E	15.50	15.87	4
E1	13.46	14.16	5
E2	4.52	5.49	3
e	5.44 BSC		
L	14.90	15.40	
L1	3.96	4.16	6
Ø P	3.56	3.65	7
Ø P1	7.19 ref.		
Q	5.31	5.69	
S	5.54	5.74	

**Notes**

- (1) Package reference: JEDEC® TO247, variation AC
- (2) All dimensions are in mm
- (3) Slot required, notch may be rounded
- (4) Dimension D and E do not include mold flash. Mold flash shall not exceed 0.127 mm per side. These dimensions are measured at the outermost extremes of the plastic body
- (5) Thermal pad contour optional with dimensions D1 and E1
- (6) Lead finish uncontrolled in L1
- (7) Ø P to have a maximum draft angle of 1.5° to the top of the part with a maximum hole diameter of 3.91 mm
- (8) Dimension b2 and b4 does not include dambar protrusion. Allowable dambar protrusion shall be 0.1 mm total in excess of b2 and b4 dimension at maximum material condition





**VERSION 2: FACILITY CODE = Y**



DIM.	MILLIMETERS		NOTES
	MIN.	MAX.	
A	4.58	5.31	
A1	2.21	2.59	
A2	1.17	2.49	
b	0.99	1.40	
b1	0.99	1.35	
b2	1.53	2.39	
b3	1.65	2.37	
b4	2.42	3.43	
b5	2.59	3.38	
c	0.38	0.86	
c1	0.38	0.76	
D	19.71	20.82	
D1	13.08	-	

DIM.	MILLIMETERS		NOTES
	MIN.	MAX.	
D2	0.51	1.30	
E	15.29	15.87	
E1	13.72	-	
e	5.46 BSC		
Ø k	0.254		
L	14.20	16.25	
L1	3.71	4.29	
Ø P	3.51	3.66	
Ø P1	-	7.39	
Q	5.31	5.69	
R	4.52	5.49	
S	5.51 BSC		

**Notes**

- (1) Dimensioning and tolerancing per ASME Y14.5M-1994
- (2) Contour of slot optional
- (3) Dimension D and E do not include mold flash. Mold flash shall not exceed 0.127 mm (0.005") per side. These dimensions are measured at the outermost extremes of the plastic body
- (4) Thermal pad contour optional with dimensions D1 and E1
- (5) Lead finish uncontrolled in L1
- (6) Ø P to have a maximum draft angle of 1.5 to the top of the part with a maximum hole diameter of 3.91 mm (0.154")
- (7) Outline conforms to JEDEC outline TO-247 with exception of dimension c



**VERSION 3: FACILITY CODE = N**



MILLIMETERS		
DIM.	MIN.	MAX.
A	4.65	5.31
A1	2.21	2.59
A2	1.17	1.37
b	0.99	1.40
b1	0.99	1.35
b2	1.65	2.39
b3	1.65	2.34
b4	2.59	3.43
b5	2.59	3.38
c	0.38	0.89
c1	0.38	0.84
D	19.71	20.70
D1	13.08	-

MILLIMETERS		
DIM.	MIN.	MAX.
D2	0.51	1.35
E	15.29	15.87
E1	13.46	-
e	5.46 BSC	
k	0.254	
L	14.20	16.10
L1	3.71	4.29
N	7.62 BSC	
P	3.56	3.66
P1	-	7.39
Q	5.31	5.69
R	4.52	5.49
S	5.51 BSC	

ECN: E20-0545-Rev. F, 19-Oct-2020  
 DWG: 5971

**Notes**

- (1) Dimensioning and tolerancing per ASME Y14.5M-1994
- (2) Contour of slot optional
- (3) Dimension D and E do not include mold flash. Mold flash shall not exceed 0.127 mm (0.005") per side. These dimensions are measured at the outermost extremes of the plastic body
- (4) Thermal pad contour optional with dimensions D1 and E1
- (5) Lead finish uncontrolled in L1
- (6) Ø P to have a maximum draft angle of 1.5 to the top of the part with a maximum hole diameter of 3.91 mm (0.154")



## Disclaimer

ALL PRODUCT, PRODUCT SPECIFICATIONS AND DATA ARE SUBJECT TO CHANGE WITHOUT NOTICE TO IMPROVE RELIABILITY, FUNCTION OR DESIGN OR OTHERWISE.

Vishay Intertechnology, Inc., its affiliates, agents, and employees, and all persons acting on its or their behalf (collectively, "Vishay"), disclaim any and all liability for any errors, inaccuracies or incompleteness contained in any datasheet or in any other disclosure relating to any product.

Vishay makes no warranty, representation or guarantee regarding the suitability of the products for any particular purpose or the continuing production of any product. To the maximum extent permitted by applicable law, Vishay disclaims (i) any and all liability arising out of the application or use of any product, (ii) any and all liability, including without limitation special, consequential or incidental damages, and (iii) any and all implied warranties, including warranties of fitness for particular purpose, non-infringement and merchantability.

Statements regarding the suitability of products for certain types of applications are based on Vishay's knowledge of typical requirements that are often placed on Vishay products in generic applications. Such statements are not binding statements about the suitability of products for a particular application. It is the customer's responsibility to validate that a particular product with the properties described in the product specification is suitable for use in a particular application. Parameters provided in datasheets and / or specifications may vary in different applications and performance may vary over time. All operating parameters, including typical parameters, must be validated for each customer application by the customer's technical experts. Product specifications do not expand or otherwise modify Vishay's terms and conditions of purchase, including but not limited to the warranty expressed therein.

Hyperlinks included in this datasheet may direct users to third-party websites. These links are provided as a convenience and for informational purposes only. Inclusion of these hyperlinks does not constitute an endorsement or an approval by Vishay of any of the products, services or opinions of the corporation, organization or individual associated with the third-party website. Vishay disclaims any and all liability and bears no responsibility for the accuracy, legality or content of the third-party website or for that of subsequent links.

Except as expressly indicated in writing, Vishay products are not designed for use in medical, life-saving, or life-sustaining applications or for any other application in which the failure of the Vishay product could result in personal injury or death. Customers using or selling Vishay products not expressly indicated for use in such applications do so at their own risk. Please contact authorized Vishay personnel to obtain written terms and conditions regarding products designed for such applications.

No license, express or implied, by estoppel or otherwise, to any intellectual property rights is granted by this document or by any conduct of Vishay. Product names and markings noted herein may be trademarks of their respective owners.