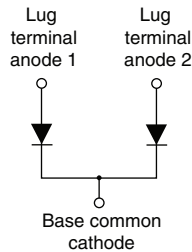

FRED Pt[®] Gen 5, Ultrafast Rectifier Diode, 600 V, 240 A

TO-244

FEATURES

- Ultrafast and optimized Q_{rr}
- Best in class forward voltage drop and switching losses trade off
- Optimized for high speed operation
- 175 °C maximum operation junction temperature
- UL approved file E222165
- Material categorization: for definitions of compliance please see www.vishay.com/doc?99912

**RoHS
COMPLIANT**
BENEFITS

- Reduced RFI and EMI
- Higher frequency operation
- Reduced snubbing
- Reduced parts count

DESCRIPTION / APPLICATIONS

Featuring a unique combination of low conduction and switching losses the FRED Pt[®] Gen 5 is the right choice for soft switched and resonant converters, as well as medium frequency hard switching converters.

These devices are also ideally suited for HF welding, power converters, and other applications where switching losses are significant portion of the total losses.

PRIMARY CHARACTERISTICS

$I_{F(AV)}$ at 95 °C (per module)	240 A
V_R	600 V
Q_{rr} (typical)	260 nC
t_{rr}	52 ns
Type	Modules - diode, FRED Pt [®]
Package	TO-244
Circuit configuration	Two diodes common cathode

ABSOLUTE MAXIMUM RATINGS

PARAMETER	SYMBOL	TEST CONDITIONS	MAX.	UNITS
Cathode to anode voltage	V_R		600	V
Continuous forward current per diode	$I_{F(DC)}$	$T_C = 25\text{ °C}$	229	A
		$T_C = 85\text{ °C}$	160	
		$T_C = 115\text{ °C}$	120	
Non-repetitive single pulse forward current per diode	I_{FSM}	$T_C = 25\text{ °C}$	1300	
Maximum power dissipation per diode	P_D	$T_C = 25\text{ °C}$	395	W
		$T_C = 115\text{ °C}$	158	
Storage temperature range	T_{Stg}		-40 to +150	°C
Operating junction temperature range	T_J		-40 to +175	°C

ELECTRICAL SPECIFICATIONS PER LEG ($T_J = 25\text{ °C}$ unless otherwise specified)

PARAMETER	SYMBOL	TEST CONDITIONS	MIN.	TYP.	MAX.	UNITS
Breakdown voltage	V_{BR}	$I_R = 200\text{ }\mu\text{A}$	600	-	-	V
Forward voltage	V_{FM}	$I_F = 120\text{ A}$	-	1.52	1.68	
		$I_F = 240\text{ A}$	-	1.67	1.96	
		$I_F = 120\text{ A}, T_J = 150\text{ °C}$	-	1.17	-	
		$I_F = 240\text{ A}, T_J = 150\text{ °C}$	-	1.46	-	
Reverse leakage current	I_{RM}	$T_J = 150\text{ °C}, V_R = 600\text{ V}$	-	0.18	0.5	mA
Series inductance	L_S	From top of terminal hole to mounting plane	-	5	-	nH
Maximum junction capacitance per leg	C_T	$V_{DC} = 5\text{ V}, f = 1\text{ MHz}, 25\text{ °C}$	-	-	0.7	nF



DYNAMIC RECOVERY CHARACTERISTICS (T _J = 25 °C unless otherwise specified)							
PARAMETER	SYMBOL	TEST CONDITIONS		MIN.	TYP.	MAX.	UNITS
Reverse recovery time	t _{rr}	T _J = 25 °C	I _F = 50 A, di/dt = 200 A/μs, V _R = 300 V	-	52	-	ns
		T _J = 125 °C		-	135	-	
Peak recovery current	I _{RRM}	T _J = 25 °C		-	4.0	-	A
		T _J = 125 °C		-	11.0	-	
Reverse recovery charge	Q _{rr}	T _J = 25 °C		-	260	-	nC
		T _J = 125 °C		-	1530	-	

THERMAL - MECHANICAL SPECIFICATIONS						
PARAMETER	SYMBOL	MIN.	TYP.	MAX.	UNITS	
Thermal resistance, junction to case	per leg	-	-	0.38	°C/W	
	per module	-	-	0.19		
Thermal resistance, case to heatsink	R _{thCS}	-	0.10	-		
Weight		-	68	-	g	
		-	2.4	-	oz.	
Mounting torque		30 (3.4)	-	40 (4.6)	lbf · in (N · m)	
Mounting torque center hole		12 (1.4)	-	18 (2.1)		
Terminal torque		30 (3.4)	-	40 (4.6)		
Vertical pull		-	-	80	lbf · in	
2" lever pull		-	-	35		
Case style		TO-244				

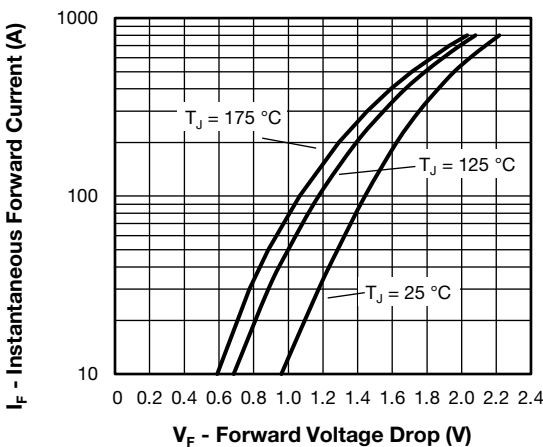

Fig. 1 - Typical Forward Voltage Drop vs. Instantaneous Forward Current (Per Diode)

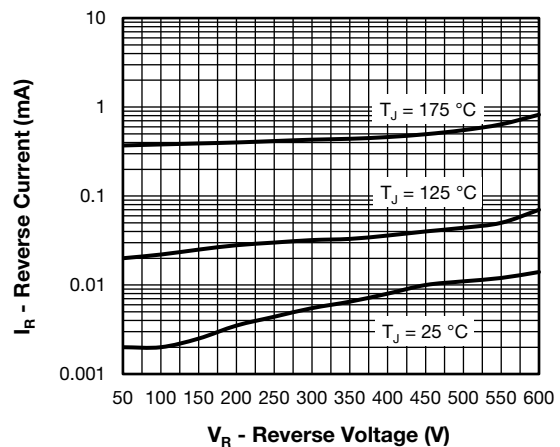

Fig. 2 - Typical Reverse Current vs. Reverse Voltage (Per Diode)

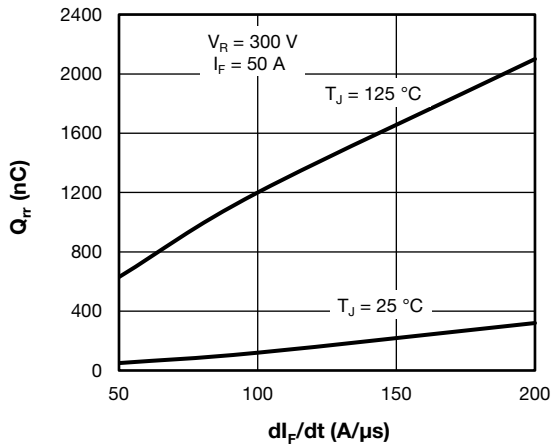

Fig. 3 - Typical Reverse Recovery Charge vs di_F/dt (Per Diode)

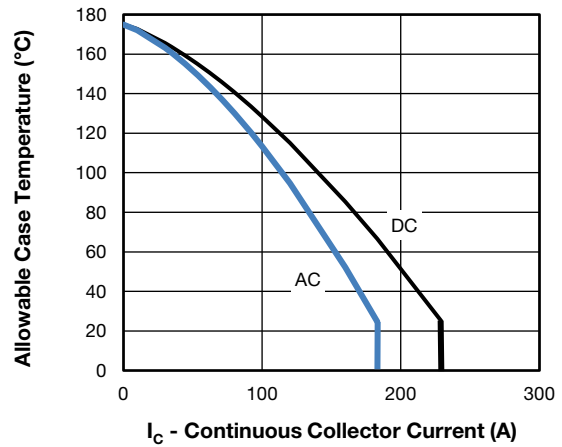

Fig. 6 - Maximum Continuous Forward Current vs. Case Temperature

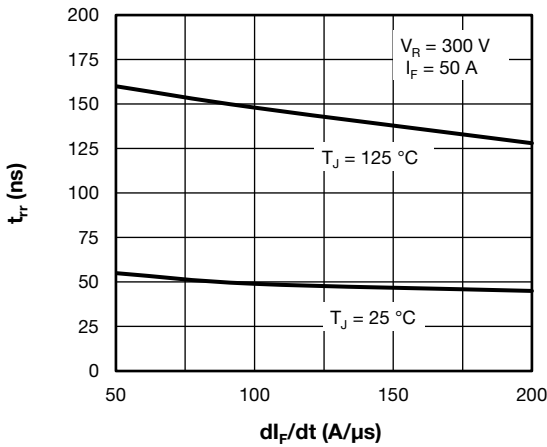

Fig. 4 - Typical Reverse Recovery Time vs di_F/dt (Per Diode)

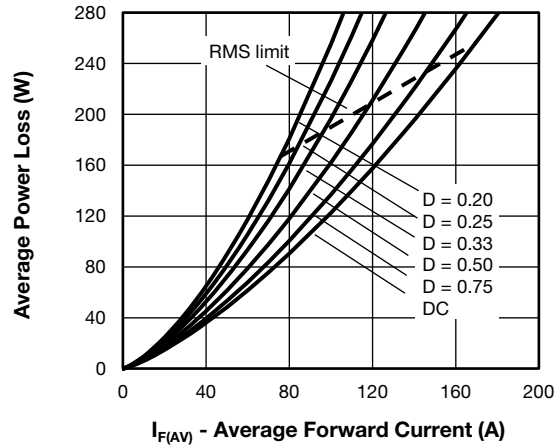

Fig. 7 - Average Power Loss vs. Average Forward Current (Forward Power Loss Characteristics)

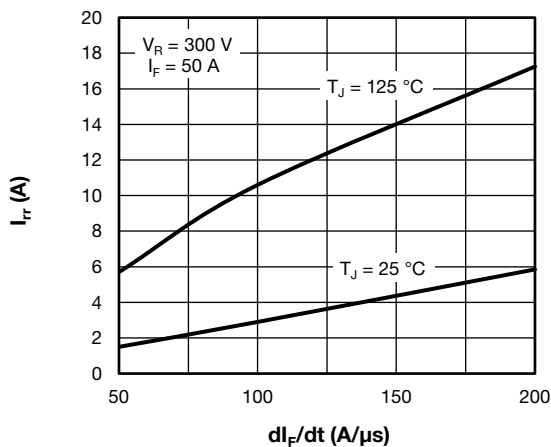

Fig. 5 - Typical Reverse Recovery Current vs di_F/dt (Per Diode)

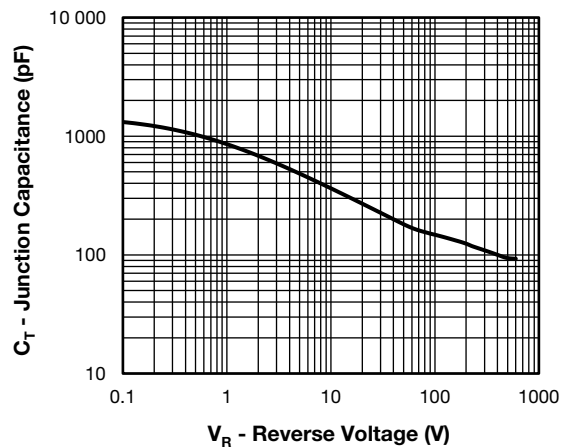

Fig. 8 - Typical Junction Capacitance vs. Reverse Voltage

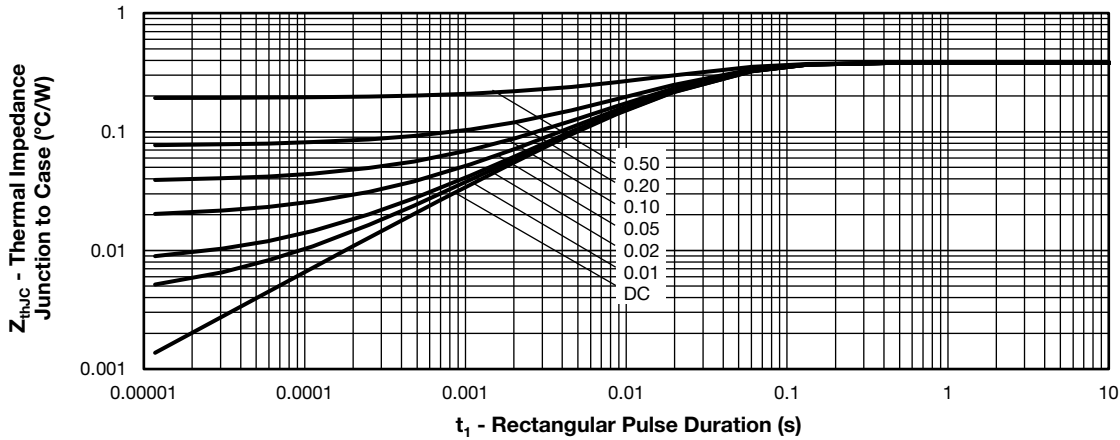

Fig. 9 - Z_{thJC} Maximum Thermal Impedance Junction to Case vs. t_1 Rectangular Pulse Duration

ORDERING INFORMATION TABLE

Device code	VS-VS	5HD	240	C	W	60
	①	②	③	④	⑤	⑥
	1	2	3	4	5	6
	-	-	-	-	-	-
	-	-	-	-	-	-
	-	-	-	-	-	-
	-	-	-	-	-	-
	-	-	-	-	-	-
	-	-	-	-	-	-
	-	-	-	-	-	-

- 1 - Vishay Semiconductors product
- 2 - 5HD = high speed FRED Pt[®] Gen 5
- 3 - Current rating (240 = 240 A)
- 4 - Circuit configuration:
C = two diodes common cathode
- 5 - W = TO-244 wire bondable not isolated
- 6 - Voltage rating (60 = 600 V)

CIRCUIT CONFIGURATION		
CIRCUIT	CIRCUIT CONFIGURATION CODE	CIRCUIT DRAWING
Two diodes common cathode	C	

LINKS TO RELATED DOCUMENTS	
Dimensions	www.vishay.com/doc?95021



DIMENSIONS in millimeters (inches)

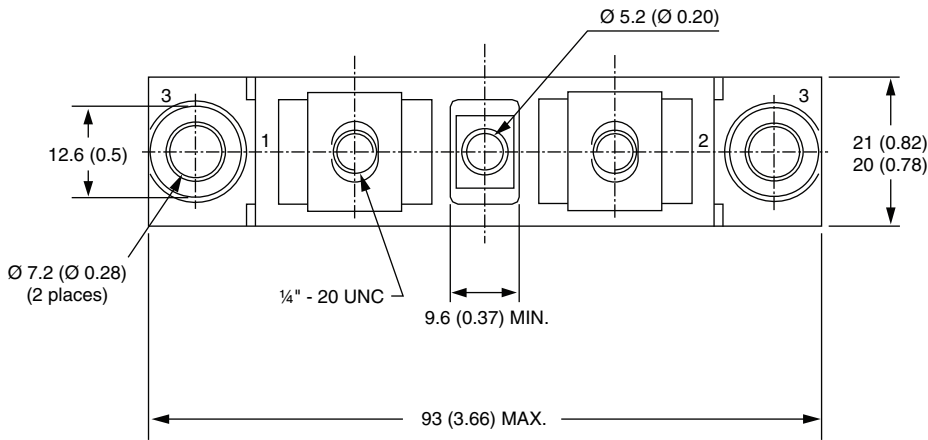
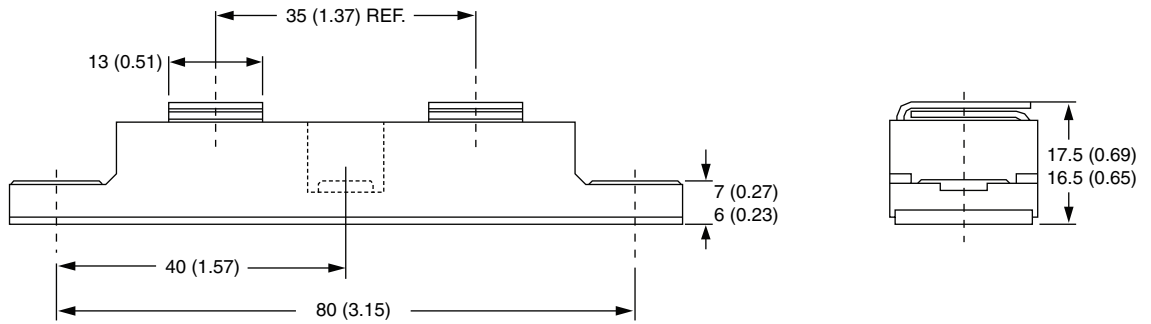



Disclaimer

ALL PRODUCT, PRODUCT SPECIFICATIONS AND DATA ARE SUBJECT TO CHANGE WITHOUT NOTICE TO IMPROVE RELIABILITY, FUNCTION OR DESIGN OR OTHERWISE.

Vishay Intertechnology, Inc., its affiliates, agents, and employees, and all persons acting on its or their behalf (collectively, "Vishay"), disclaim any and all liability for any errors, inaccuracies or incompleteness contained in any datasheet or in any other disclosure relating to any product.

Vishay makes no warranty, representation or guarantee regarding the suitability of the products for any particular purpose or the continuing production of any product. To the maximum extent permitted by applicable law, Vishay disclaims (i) any and all liability arising out of the application or use of any product, (ii) any and all liability, including without limitation special, consequential or incidental damages, and (iii) any and all implied warranties, including warranties of fitness for particular purpose, non-infringement and merchantability.

Statements regarding the suitability of products for certain types of applications are based on Vishay's knowledge of typical requirements that are often placed on Vishay products in generic applications. Such statements are not binding statements about the suitability of products for a particular application. It is the customer's responsibility to validate that a particular product with the properties described in the product specification is suitable for use in a particular application. Parameters provided in datasheets and / or specifications may vary in different applications and performance may vary over time. All operating parameters, including typical parameters, must be validated for each customer application by the customer's technical experts. Product specifications do not expand or otherwise modify Vishay's terms and conditions of purchase, including but not limited to the warranty expressed therein.

Hyperlinks included in this datasheet may direct users to third-party websites. These links are provided as a convenience and for informational purposes only. Inclusion of these hyperlinks does not constitute an endorsement or an approval by Vishay of any of the products, services or opinions of the corporation, organization or individual associated with the third-party website. Vishay disclaims any and all liability and bears no responsibility for the accuracy, legality or content of the third-party website or for that of subsequent links.

Except as expressly indicated in writing, Vishay products are not designed for use in medical, life-saving, or life-sustaining applications or for any other application in which the failure of the Vishay product could result in personal injury or death. Customers using or selling Vishay products not expressly indicated for use in such applications do so at their own risk. Please contact authorized Vishay personnel to obtain written terms and conditions regarding products designed for such applications.

No license, express or implied, by estoppel or otherwise, to any intellectual property rights is granted by this document or by any conduct of Vishay. Product names and markings noted herein may be trademarks of their respective owners.