

## Silicon NPN Phototransistor

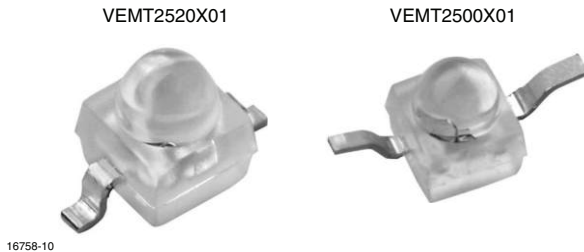

### DESCRIPTION

VENT2500X01 series are silicon NPN epitaxial planar phototransistors in a miniature dome lens, clear epoxy package for surface mounting. The device is sensitive to visible and near infrared radiation.

### FEATURES

- Package type: surface mount
- Package form: GW, RGW
- Dimensions (L x W x H in mm): 2.3 x 2.3 x 2.8
- AEC-Q101 qualified
- High radiant sensitivity
- Suitable for visible and near infrared radiation
- Fast response times
- Angle of half sensitivity:  $\varphi = \pm 15^\circ$
- Package matched with IR emitter series VSMB2000X01
- Floor life: 4 weeks, MSL 2a, acc. J-STD-020
- Lead (Pb)-free reflow soldering
- Compliant to RoHS directive 2002/95/EC and in accordance to WEEE 2002/96/EC
- Halogen-free according to IEC 61249-2-21 definition
- Find out more about Vishay's Automotive Grade Product requirements at: [www.vishay.com/applications](http://www.vishay.com/applications)



**RoHS**  
COMPLIANT  
HALOGEN  
**FREE**



### APPLICATIONS

- Detector in automotive applications
- Photo interrupters
- Miniature switches
- Counters
- Encoders
- Position sensors

### PRODUCT SUMMARY

COMPONENT	$I_{ca}$ (mA)	$\varphi$ (deg)	$\lambda_{0.1}$ (nm)
VENT2500X01	6	$\pm 15$	470 to 1090
VENT2520X01	6	$\pm 15$	470 to 1090

#### Note

Test condition see table "Basic Characteristics"

### ORDERING INFORMATION

ORDERING CODE	PACKAGING	REMARKS	PACKAGE FORM
VENT2500X01	Tape and reel	MOQ: 6000 pcs, 6000 pcs/reel	Reverse gullwing
VENT2520X01	Tape and reel	MOQ: 6000 pcs, 6000 pcs/reel	Gullwing

#### Note

MOQ: minimum order quantity

### ABSOLUTE MAXIMUM RATINGS

PARAMETER	TEST CONDITION	SYMBOL	VALUE	UNIT
Collector emitter voltage		$V_{CEO}$	20	V
Emitter collector voltage		$V_{ECO}$	7	V
Collector current		$I_C$	50	mA
Power power dissipation	$T_{amb} \leq 75^\circ C$	$P_V$	100	mW



ABSOLUTE MAXIMUM RATINGS				
PARAMETER	TEST CONDITION	SYMBOL	VALUE	UNIT
Junction temperature		$T_j$	100	$^{\circ}\text{C}$
Operating temperature range		$T_{\text{amb}}$	- 40 to + 100	$^{\circ}\text{C}$
Storage temperature range		$T_{\text{stg}}$	- 40 to + 100	$^{\circ}\text{C}$
Soldering temperature	Acc. reflow profile fig. 7	$T_{\text{sd}}$	260	$^{\circ}\text{C}$
Thermal resistance junction/ambient	Acc. J-STD-051	$R_{\text{thJA}}$	250	K/W

**Note**

$T_{\text{amb}} = 25^{\circ}\text{C}$ , unless otherwise specified

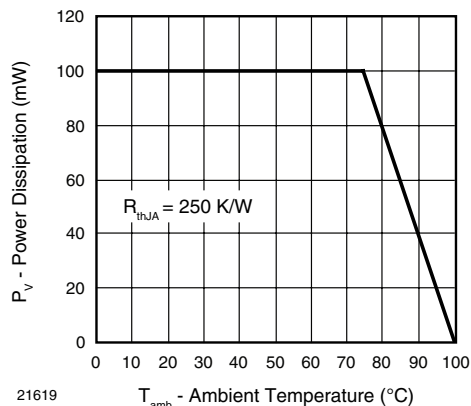

Fig. 1 - Power Dissipation Limit vs. Ambient Temperature

BASIC CHARACTERISTICS						
PARAMETER	TEST CONDITION	SYMBOL	MIN.	TYP.	MAX.	UNIT
Collector emitter breakdown voltage	$I_C = 0.1\text{ mA}$	$V_{\text{CEO}}$	20			V
Collector dark current	$V_{\text{CE}} = 5\text{ V}, E = 0$	$I_{\text{CEO}}$		1	100	nA
Collector emitter capacitance	$V_{\text{CE}} = 0\text{ V}, f = 1\text{ MHz}, E = 0$	$C_{\text{CEO}}$		25		pF
Collector light current	$E_e = 1\text{ mW/cm}^2, \lambda = 950\text{ nm}, V_{\text{CE}} = 5\text{ V}$	$I_{\text{CA}}$	3	6	9	mA
Angle of half sensitivity		$\phi$		$\pm 15$		deg
Wavelength of peak sensitivity		$\lambda_p$		850		nm
Range of spectral bandwidth		$\lambda_{0.1}$		470 to 1090		nm
Collector emitter saturation voltage	$I_C = 0.05\text{ mA}$	$V_{\text{CEsat}}$			0.4	V

**Note**

$T_{\text{amb}} = 25^{\circ}\text{C}$ , unless otherwise specified

## BASIC CHARACTERISTICS

$T_{amb} = 25\text{ }^{\circ}\text{C}$ , unless otherwise specified

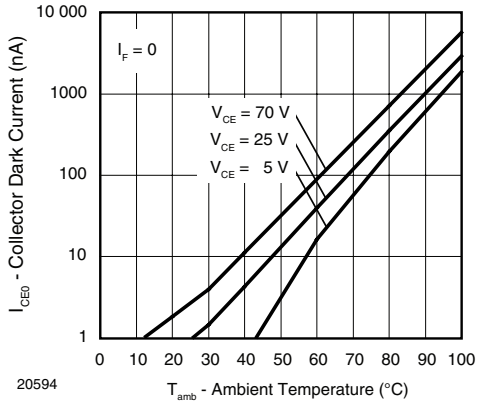

Fig. 2 - Collector Dark Current vs. Ambient Temperature

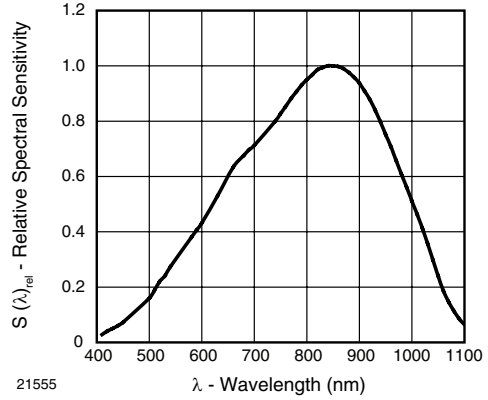

Fig. 5 - Relative Spectral Sensitivity vs. Wavelength

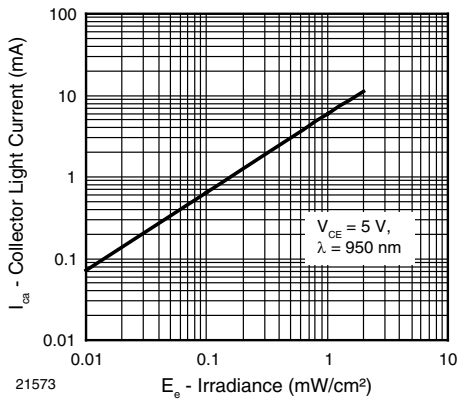

Fig. 3 - Collector Light Current vs. Irradiance

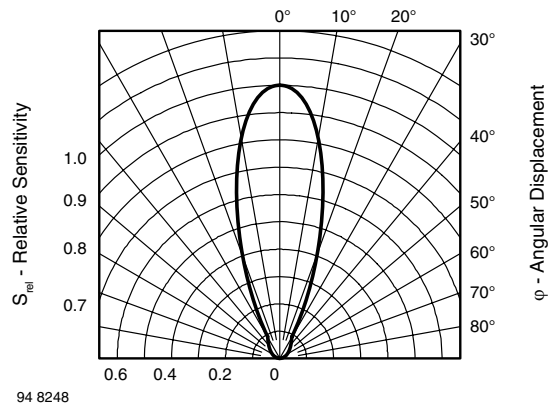

Fig. 6 - Relative Radiant Sensitivity vs. Angular Displacement

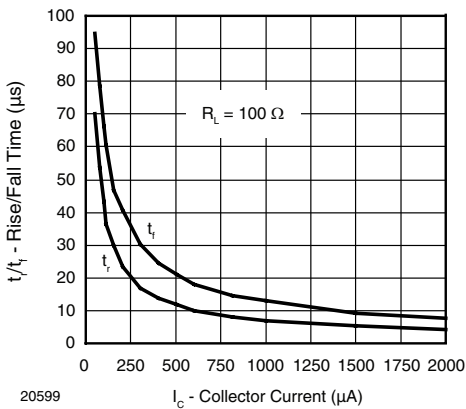

Fig. 4 - Rise/Fall Time vs. Collector Current

## REFLOW SOLDER PROFILE

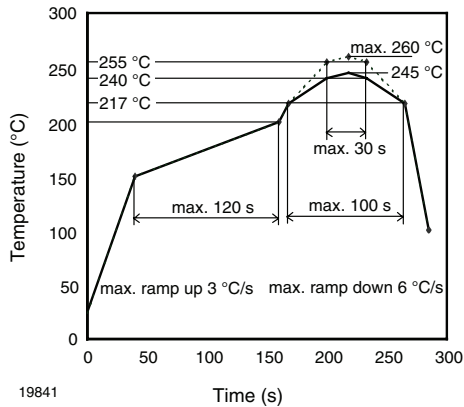

Fig. 7 - Lead (Pb)-free Reflow Solder Profile acc. J-STD-020

## DRYPACK

Devices are packed in moisture barrier bags (MBB) to prevent the products from moisture absorption during transportation and storage. Each bag contains a desiccant.

## FLOOR LIFE

Floor life (time between soldering and removing from MBB) must not exceed the time indicated on MBB label:

Floor life: 4 weeks

Conditions:  $T_{amb} < 30\text{ °C}$ , RH < 60 %

Moisture sensitivity level 2a, acc. to J-STD-020.

## DRYING

In case of moisture absorption devices should be baked before soldering. Conditions see J-STD-020 or label. Devices taped on reel dry using recommended conditions 192 h at 40 °C (+ 5 °C), RH < 5 %.

## PACKAGE DIMENSIONS VENT2500X01 in millimeters

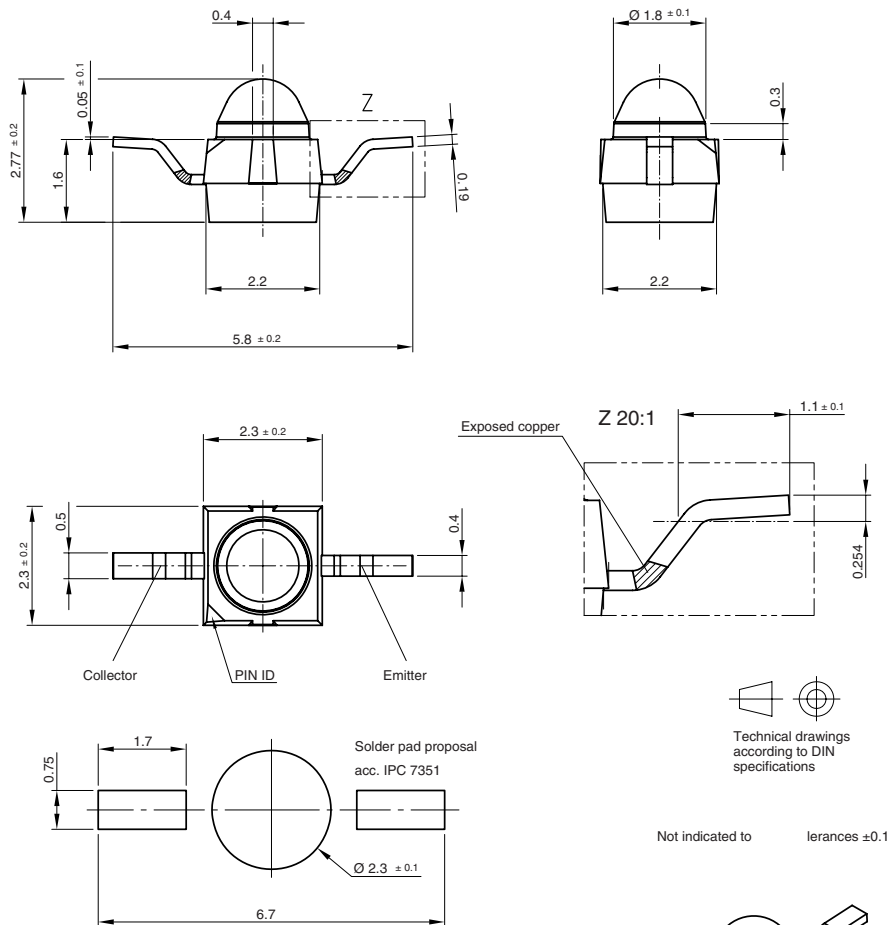

Drawing-No.: 6.544-5391.01-4  
Issue: 1; 26.09.08  
21570

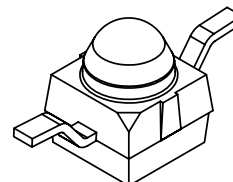



# VENT2500X01, VEMT2520X01

Silicon NPN Phototransistor

Vishay Semiconductors

## PACKAGE DIMENSIONS VEMT2520X01 in millimeters

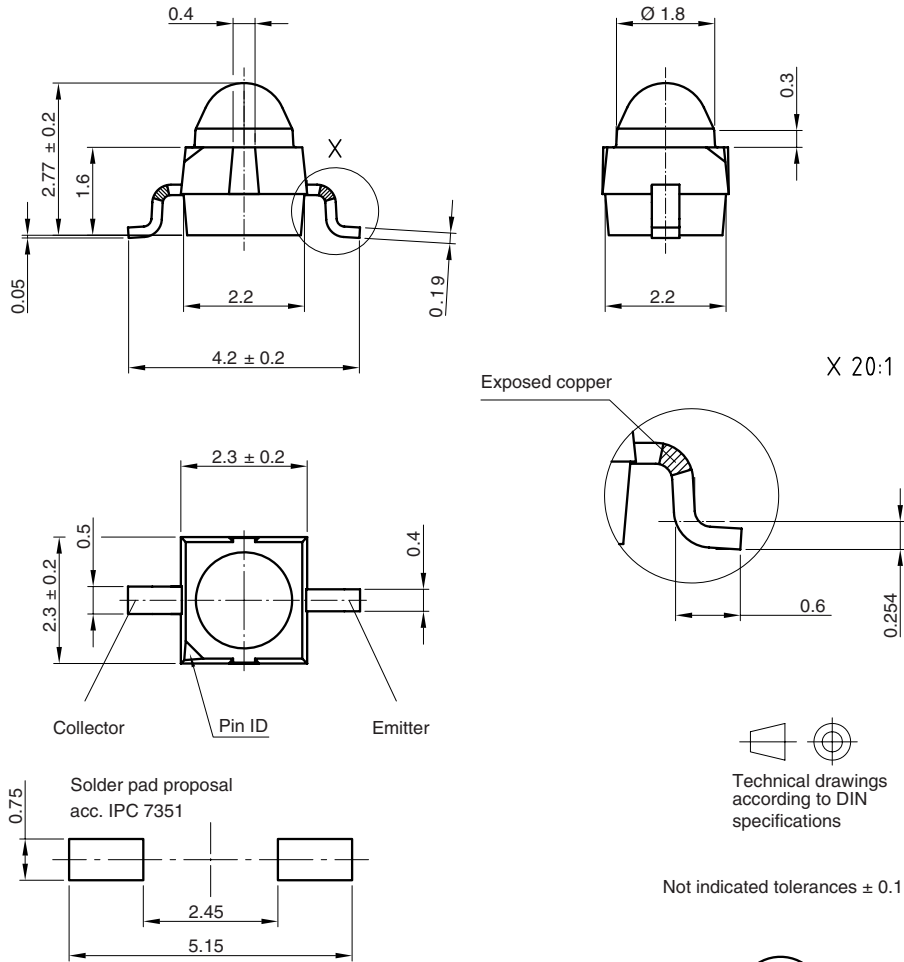

Drawing-No.: 6.544-5383.01-4  
Issue: 4; 28.01.09  
21569

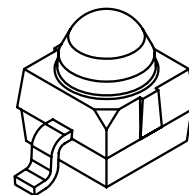

# VENT2500X01, VEMT2520X01

Vishay Semiconductors

Silicon NPN Phototransistor



## TAPE AND REEL DIMENSIONS VEMT2500X01 in millimeters

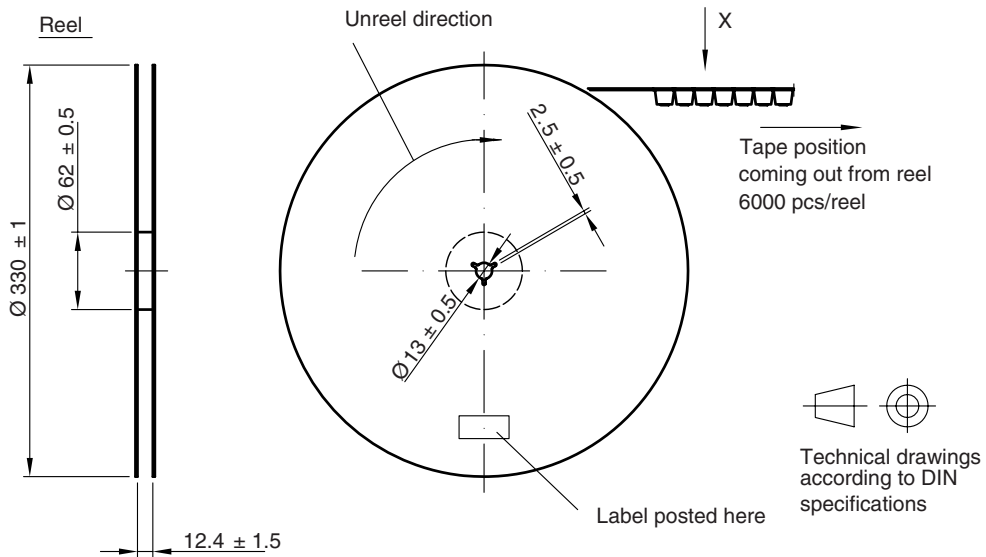

### Leader and trailer tape:

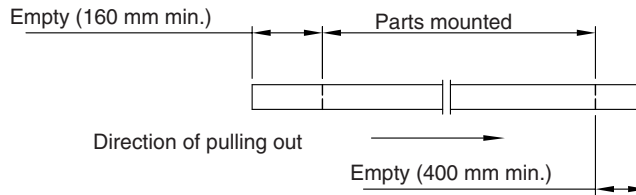

### Terminal position in tape

Device	Lead I	Lead II
VENT2000	Collector	Emitter
VEMT2500	Collector	Emitter
VEMD2000	Cathode	Anode
VSMB2000	Cathode	Anode

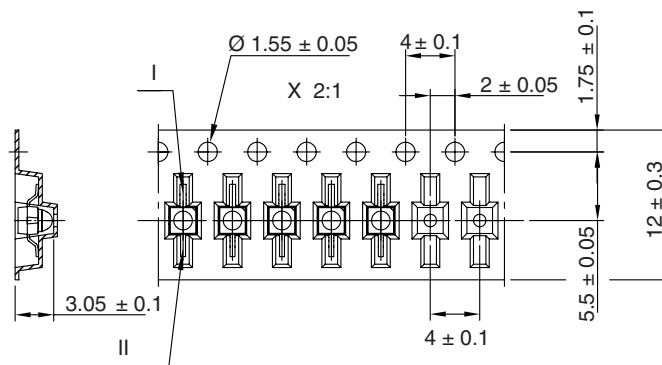

Drawing-No.: 9.800-5100.01-4  
 Issue: X; 29.04.09  
 21572



# VENT2500X01, VEMT2520X01

Silicon NPN Phototransistor

Vishay Semiconductors

## TAPE AND REEL DIMENSIONS VEMT2520X01 in millimeters

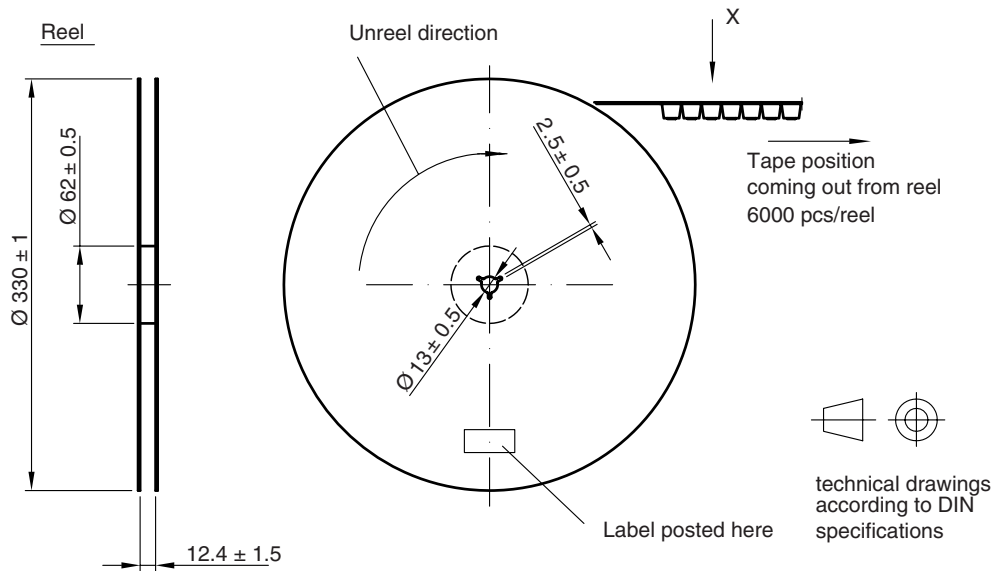

### Leader and trailer tape:

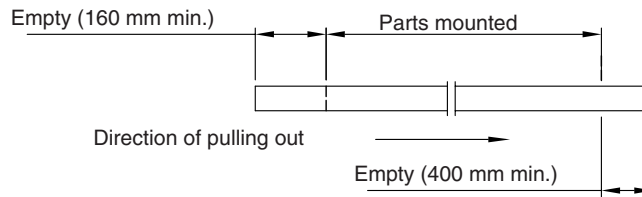

### Terminal position in tape

Device	Lead I	Lead II
VENT2020	Collector	Emitter
VEMT2520		
VSMB2020	Cathode	Anode
VEMD2020		

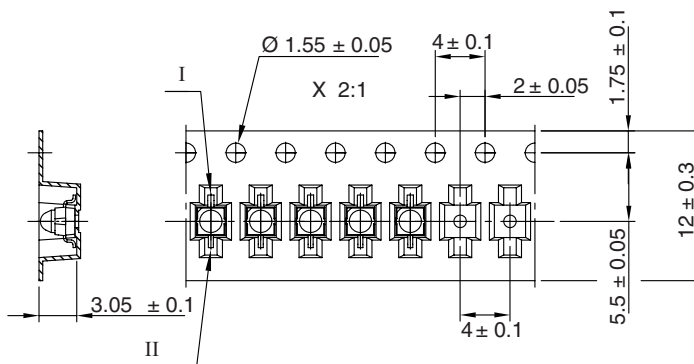

Drawing-No.: 9.800-5091.01-4

Issue: X; 29.04.09

21571



## **Disclaimer**

ALL PRODUCT, PRODUCT SPECIFICATIONS AND DATA ARE SUBJECT TO CHANGE WITHOUT NOTICE TO IMPROVE RELIABILITY, FUNCTION OR DESIGN OR OTHERWISE.

Vishay Intertechnology, Inc., its affiliates, agents, and employees, and all persons acting on its or their behalf (collectively, "Vishay"), disclaim any and all liability for any errors, inaccuracies or incompleteness contained in any datasheet or in any other disclosure relating to any product.

Vishay makes no warranty, representation or guarantee regarding the suitability of the products for any particular purpose or the continuing production of any product. To the maximum extent permitted by applicable law, Vishay disclaims (i) any and all liability arising out of the application or use of any product, (ii) any and all liability, including without limitation special, consequential or incidental damages, and (iii) any and all implied warranties, including warranties of fitness for particular purpose, non-infringement and merchantability.

Statements regarding the suitability of products for certain types of applications are based on Vishay's knowledge of typical requirements that are often placed on Vishay products in generic applications. Such statements are not binding statements about the suitability of products for a particular application. It is the customer's responsibility to validate that a particular product with the properties described in the product specification is suitable for use in a particular application. Parameters provided in datasheets and / or specifications may vary in different applications and performance may vary over time. All operating parameters, including typical parameters, must be validated for each customer application by the customer's technical experts. Product specifications do not expand or otherwise modify Vishay's terms and conditions of purchase, including but not limited to the warranty expressed therein.

Except as expressly indicated in writing, Vishay products are not designed for use in medical, life-saving, or life-sustaining applications or for any other application in which the failure of the Vishay product could result in personal injury or death. Customers using or selling Vishay products not expressly indicated for use in such applications do so at their own risk. Please contact authorized Vishay personnel to obtain written terms and conditions regarding products designed for such applications.

No license, express or implied, by estoppel or otherwise, to any intellectual property rights is granted by this document or by any conduct of Vishay. Product names and markings noted herein may be trademarks of their respective owners.