

High Frequency 50 GHz Thin Film Chip Resistor

 CH02016
(flip chip)

 CH0402
(flip chip)

 CH0603
(flip chip)

ADDITIONAL RESOURCES



Those miniaturized components are designed in such a way that their internal reactance is very small. When correctly mounted and utilized, they function as almost pure resistors on a very large range of frequency, up to 50 GHz.

FEATURES

- Operating frequency 50 GHz
- Thin film microwave resistors
- Flip chip, wraparound or one face termination
- Small size, down to 20 mils by 16 mils
- Edged trimmed block resistors
- Pure alumina substrate (99.5 %)
- Ohmic range: 10R to 500R
- Design kits available
- Small internal reactance (LC down to 1×10^{-24})
- Tolerance 1 %, 2 %, 5 %
- TCR: 100 ppm/°C in (-55 °C, +155 °C) temperature range
- TCR: 50 ppm/°C available upon request for 10 Ω to 150 Ω ohmic range
- Material categorization: for definitions of compliance please see www.vishay.com/doc?99912



RoHS
COMPLIANT
HALOGEN
FREE
GREEN
(5-2008)

STANDARD ELECTRICAL SPECIFICATIONS

MODEL	SIZE	RESISTANCE RANGE Ω	RATED POWER Pn W	LIMITING ELEMENT VOLTAGE V	TOLERANCE ± %	TEMPERATURE COEFFICIENT ± ppm/°C
CH02016	02016	10 to 500	0.030	30	2, 5	100 (50 upon request)
CH0402	0402	10 to 500	0.050	37	1, 2, 5	100 (50 upon request)
CH0603	0603	10 to 500	0.125	50	1, 2, 5	100 (50 upon request)

DIMENSIONS in millimeters (inches)

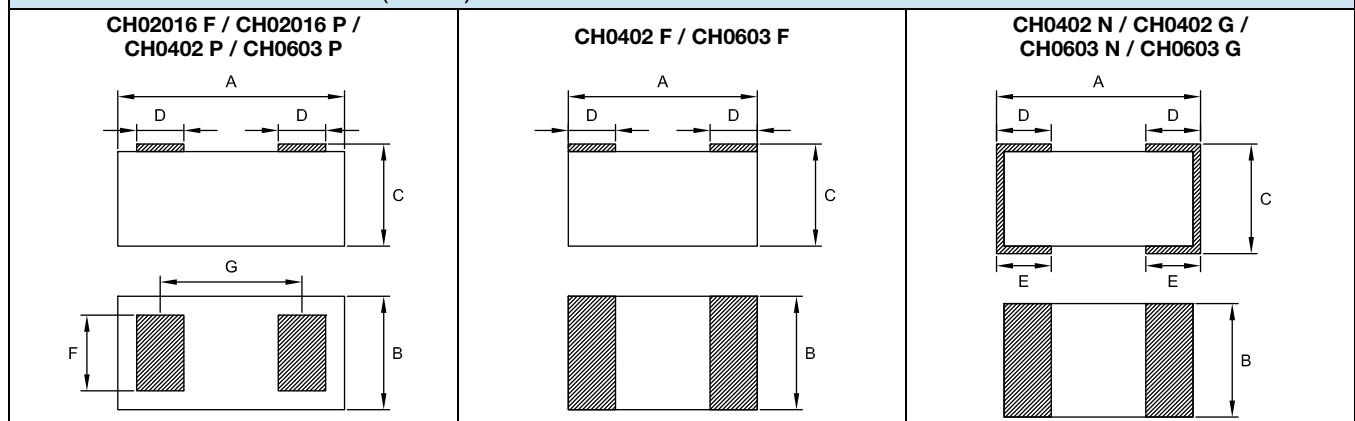

CASE SIZE MODEL / TERMINATION	DIMENSIONS						
	± 0.10 (± 0.004)	± 0.10 (± 0.004)	± 0.127 (± 0.005)	D E when applicable		± 0.050 (± 0.002)	± 0.050 (± 0.002)
				MIN.	MAX.		
CH02016 F CH02016 P	0.480 (0.020)	0.390 (0.016)	0.420 (0.016) ⁽¹⁾	0.110 (0.004)	0.150 (0.006)	0.260 (0.010)	0.300 (0.012)
CH0402 F CH0402 N CH0402 G	1.000 (0.040)	0.600 (0.023)	0.500 (0.020)	0.150 (0.006)	0.350 (0.014)	n/a	n/a
CH0402 P	1.200 (0.047)	0.600 (0.023)	0.500 (0.020)	0.110 (0.004)	0.150 (0.006)	0.320 (0.013)	0.880 (0.035)
CH0603 F CH0603 N CH0603 G	1.520 (0.060)	0.750 (0.030)	0.500 (0.020)	0.250 (0.010)	0.510 (0.020)	n/a	n/a
CH0603 P	1.720 (0.068)	0.750 (0.030)	0.500 (0.020)	0.235 (0.009)	0.275 (0.011)	0.660 (0.026)	1.355 (0.053)

Note

⁽¹⁾ ± 0.070 (± 0.003)

TOLERANCE VS. OHMIC VALUES		
Ohmic range	$10 \Omega \leq R < 50 \Omega$	$50 \Omega \leq R \leq 500 \Omega$
Tolerance CH02016	5 %	2 %, 5 %
Tolerance CH0402 and CH0603	2 %, 5 %	1 %, 2 %, 5 %

LAND PATTERN FOR F 'FLIP CHIP' TERMINATIONS in millimeters (inches)			
CHIP SIZE	$Z_{max.}$	$X_{max.}$	$G_{min.}$
02016	0.53 (0.021)	0.44 (0.017)	0.15 (0.006)
0402	1.40 (0.055)	0.65 (0.026)	0.40 (0.016)
0603	1.71 (0.067)	0.90 (0.035)	0.76 (0.030)

Note

- Suggested land pattern: According to IPC-7351

LAND PATTERN FOR N AND G WRAPAROUND TERMINATIONS in millimeters (inches)			
CHIP SIZE	$Z_{max.}$	$G_{min.}$	$X_{max.}$
0402	1.55 (0.061)	0.15 (0.006)	0.73 (0.029)
0603	2.37 (0.093)	0.35 (0.014)	0.98 (0.039)

Dimension and tolerance of land pattern shall be defined by PCB designer; PCB can be designed according to IPC-7351A "Generic Requirements for Surface Mount Design and Land Pattern Standard"



PREFERRED MODELS AND VALUES

Vishay Sfernice highly recommend to use the smallest sizes and flip chip version to get the best performances.

Recommended Values:

10R/18R/25R/50R/75R/100R/150R/180R/200R/250R/330R/500R

Those values are available with a **MOQ of 100 pieces.**

Other values can be ordered upon request, but higher MOQ will apply: 1000 pieces for CH02016, 500 pieces for CH0402, 50 pieces for CH0603.

Recommended termination:

F

Recommended tolerance:

2 %

DESIGN KITS

Design kits are available Ex Stock in CH02016 and CH0402 sizes. There are 20 pieces per recommended value. F termination. 5 % tolerance.

Those kits are packaged in pieces of tape and delivered in ESD bags.

PACKAGING

Standard packaging is plastic tape and reel for all sizes.

Paper tape and reel is available for sizes 0402 and 0603.

Waffle pack is available for all sizes.

Depending on the type of terminations, parts will be packed differently:

One face:

- Gold terminations: (P termination option): active face up
- Tin / silver terminations: (F termination option): active face down in tape and reel
active face up in waffle pack

Note

- Please refer to Vishay Sfernice Application Note "Guidelines for Vishay Sfernice Resistive and Inductive Products" for soldering recommendation (document number 52029, 3. Guidelines for Surface Mounting Components (SMD), profile number 3 applies

SIZE	MOQ	NUMBER OF PIECES PER PACKAGE			TAPE WIDTH
		WAFFLE PACK 2" x 2"	TAPE AND REEL		
			MIN.	MAX.	
02016	See MOQ mentioned on preferred models and values	484	100	5000	8 mm
0402		100			
0603		100			

PACKAGING RULES

Waffle Pack

Can be filled up to maximum quantity indicated in the table here above, taking into account the minimum order quantity. When quantity ordered exceeds maximum quantity of a single waffle pack, the waffle packs are stacked up on the top of each other and closed by one single cover. To get "not stacked up" waffle pack in case of ordered quantity > maximum number of pieces per package: Please consult Vishay Sfernice for specific ordering code.

Tape and Reel

See Part Numbering information to get the quantity desired by tape.

In regard to the CH02016 size only, up to 5 empty cavities can be found every 1000 parts in the reel. Nevertheless, the number of requested parts will be respected.

GLOBAL PART NUMBER INFORMATION

New Global Part Numbering: CH0402-50RJF (preferred part number format)

C	H	0	4	0	2	-	5	0	R	J	F	T		9	9	9	
GLOBAL MODEL CH		SIZE 02016 0402 0603		OHMIC VALUE 10R to 500R			TOLERANCE F = 1 % G = 2 % J = 5 %		TERMINATION F (flip chip): SnAg over nickel barrier N (W/A): SnAg over nickel barrier (except 02016) P (one face): ⁽¹⁾ gold bonding pads G (W/A): gold over nickel barrier (except 02016)			PACKAGING For more information see Codification of Packaging table			OPTION From 1 to 3 digits. Leave blank if no option.		

Historical Part Number example: CH02016-100RGFPT1K (tapes of 1K pieces)
CH0402-50RJF (wafer pack)

CHKIT Part Numbers ⁽²⁾:
CHKIT-02016
CHKIT-0402

Notes

- Historical part numbers are not recommended but can still be used for ordering
- ⁽¹⁾ Gold termination for application in hermetic package. Can also be mounted on PCB with SnAg solder paste
- ⁽²⁾ CHKIT for 0603 size is not available

CODIFICATION OF PACKAGING

WAFFLE PACK (available for all sizes)	
W	100 min., 1 mult.
PLASTIC TAPE (standard packaging for all sizes)	
T	100 min., 1 mult.
TA	100 min., 100 mult.
TB	250 min., 250 mult.
TC	500 min., 500 mult.
TD	1000 min., 1000 mult.
TE	2500 min., 2500 mult.
TF	Full tape (quantity depending on size of chips)
PAPER TAPE (available for 0402 and 0603)	
PT	100 min., 1 mult.
PA	100 min., 100 mult.
PB	250 min., 250 mult.
PC	500 min., 500 mult.
PD (not available for size 0402)	1000 min., 1000 mult.
PE (not available for size 0402)	2500 min., 2500 mult.
PF (not available for size 0402)	Full tape (quantity depending on size of chips)

TYPICAL HIGH FREQUENCY PERFORMANCE ELECTRICAL MODEL

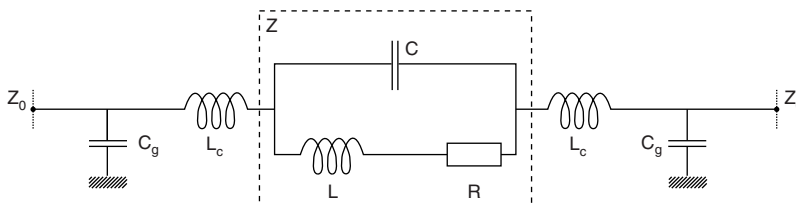

C	Internal shunt capacitance
L	Internal inductance
R	Resistance
Z	Internal impedance (R, L, C)
L _c	External connection inductance
C _g	External capacitance to ground

The complex impedance of the chip resistor is given by the following equations:

$$Z = \frac{R + j\omega(L - R^2C - L^2C\omega^2)}{1 + C[(R^2C - 2L)\omega^2 + L^2C\omega^4]}$$

$$\frac{[Z]}{R} = \frac{1}{1 + C[(R^2C - 2L)\omega^2 + L^2C\omega^4]} \times \sqrt{1 + \left[\frac{\omega(L - R^2C - L^2C\omega^2)}{R}\right]^2}$$

$$\theta = \tan^{-1} \frac{\omega(L - R^2C - L^2C\omega^2)}{R}$$

Notes

- $\omega = 2 \times \pi \times f$
- f : frequency

R, L and C are relevant to the chip resistor itself.

L_c and C_g also depend on the way the chip resistor is mounted.

It is important to notice that after assembly the external reactance of L_c and C_g will be combined to internal reactance of L and C. This combination can upgrade or downgrade the HF behavior of the component.

This is why we are displaying three sets of data:

- $\frac{[Z]}{R}$ versus frequency curves which aim to show at a glance the intrinsic HF performance of a given chip resistor
- $\frac{[Z_{total}]}{R}$ versus frequency curves which aim to show the behavior of the chip resistor when mounted

These lines are terminated with adapted source and load impedance respectively Z_s and Z_l with $Z_0 = Z_L = Z_s$ (for others configurations please consult us).

Equivalent circuit for S-parameters:

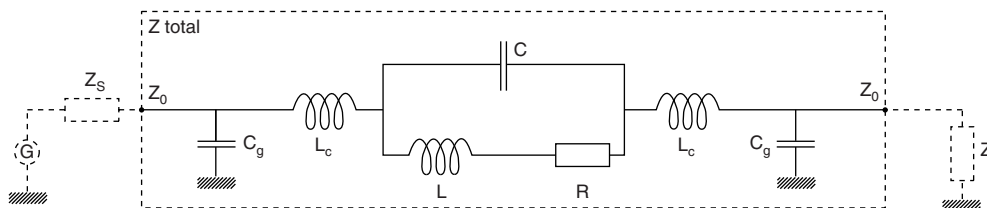

S-parameters are computed taking into account all the resistive, inductive and capacitive elements (Z_{total}) and $Z_0 = Z_L = Z_s = R$.

For simulation purposes, those S-parameter data are available for download here: www.vishay.com/doc?53061



INTERNAL IMPEDANCE CURVES

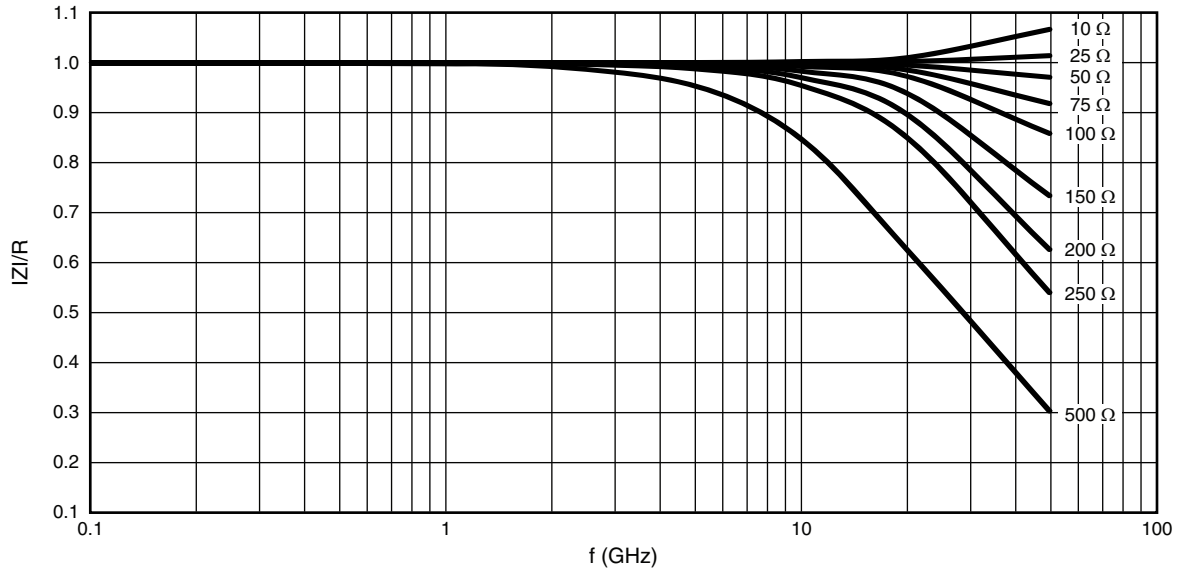

Internal impedance curve for 02016 size (F and P terminations)

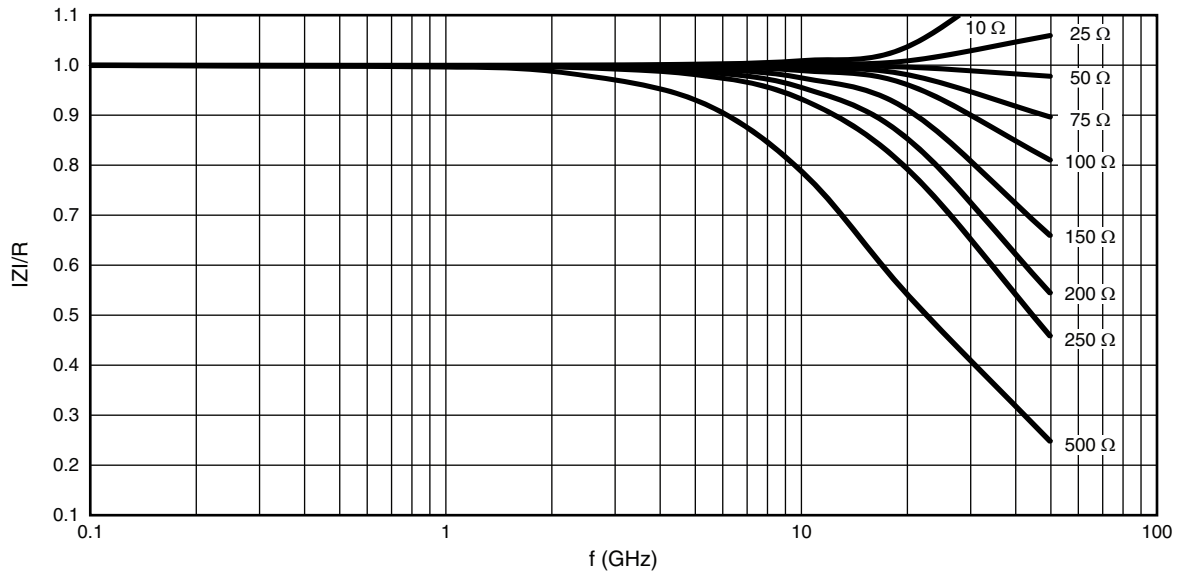

Internal impedance curve for 0402 size (F and P terminations)



INTERNAL IMPEDANCE CURVES

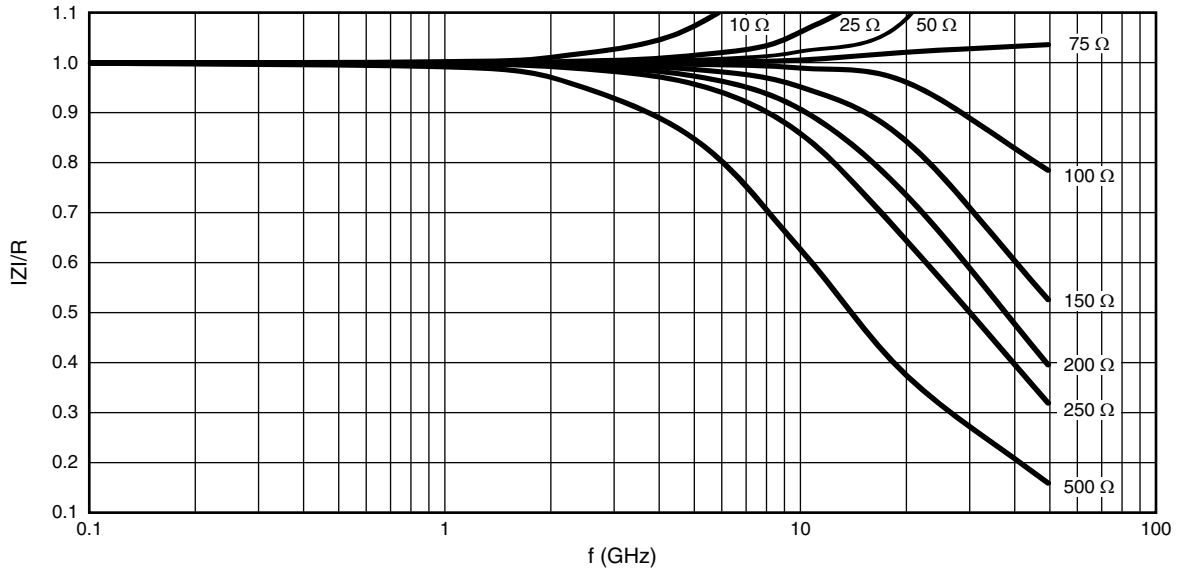

Internal impedance curve for 0402 size (N and G terminations)



Internal impedance curve for 0603 size (F and P terminations)



INTERNAL IMPEDANCE CURVES

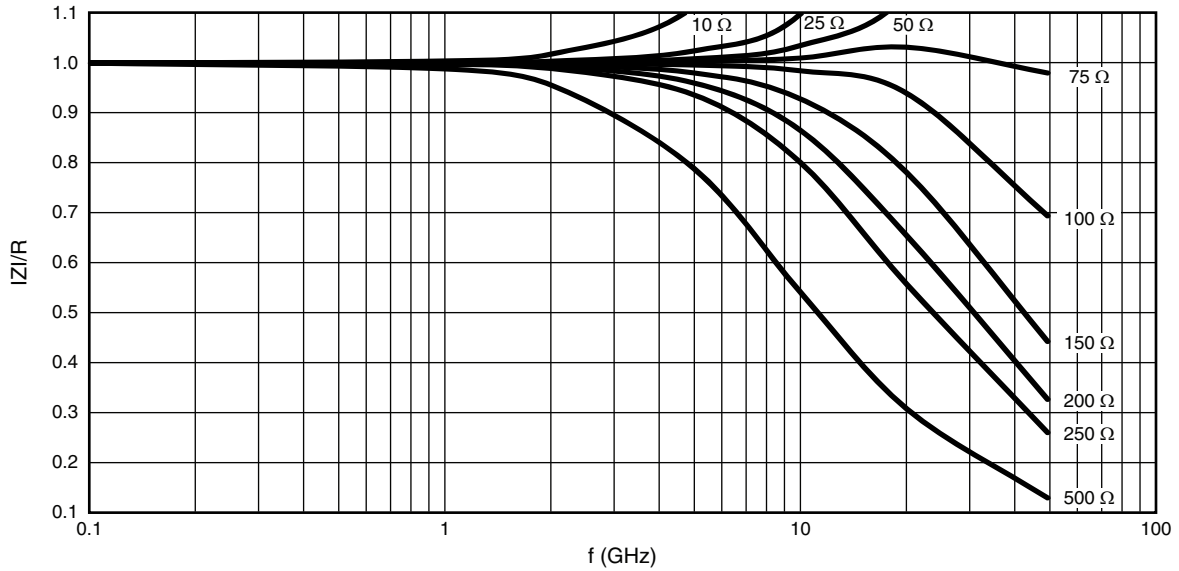

Internal impedance curve for 0603 size (N and G terminations)

INTERNAL IMPEDANCE CURVES ($|Z_{TOTAL}| / R$)

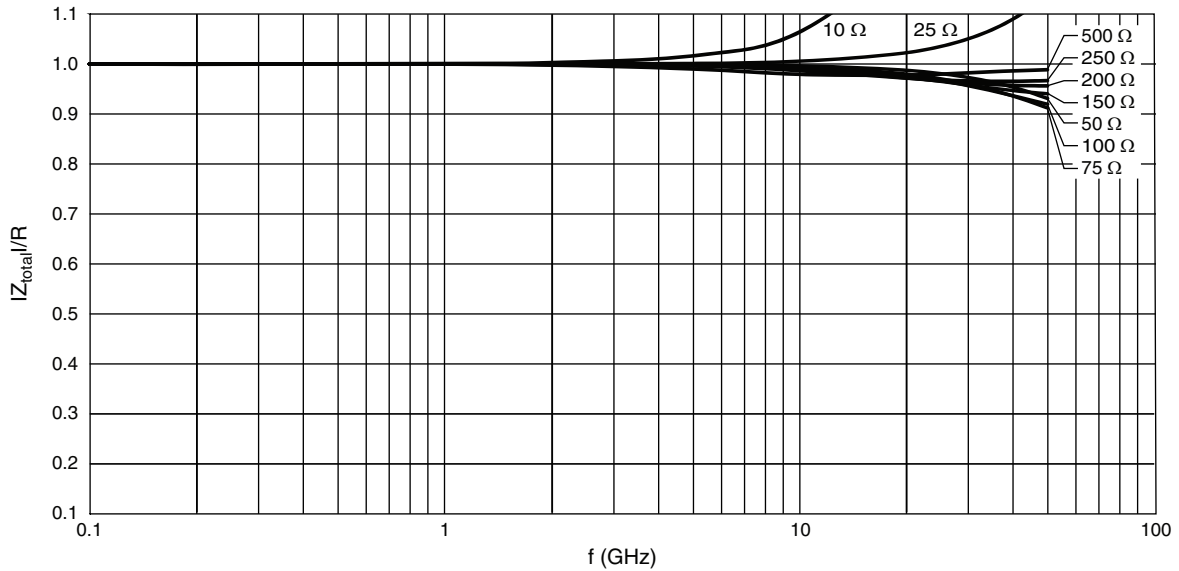

Internal impedance curve for 02016 size (F and P terminations)



INTERNAL IMPEDANCE CURVES ($|Z_{TOTAL}| / R$)

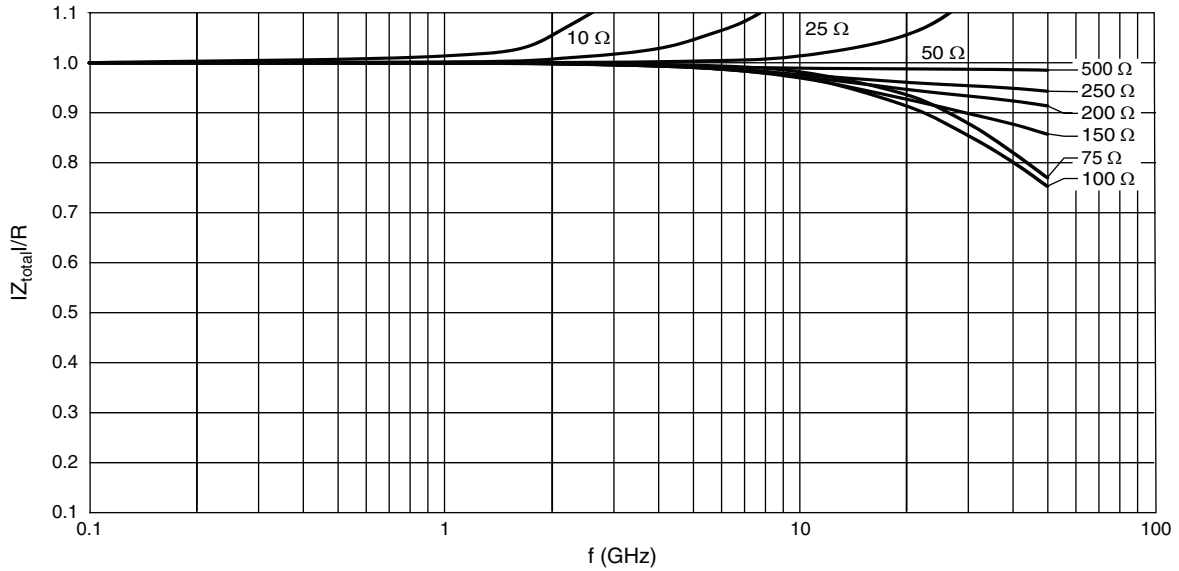

Internal impedance curve for 0402 size (F and P terminations)

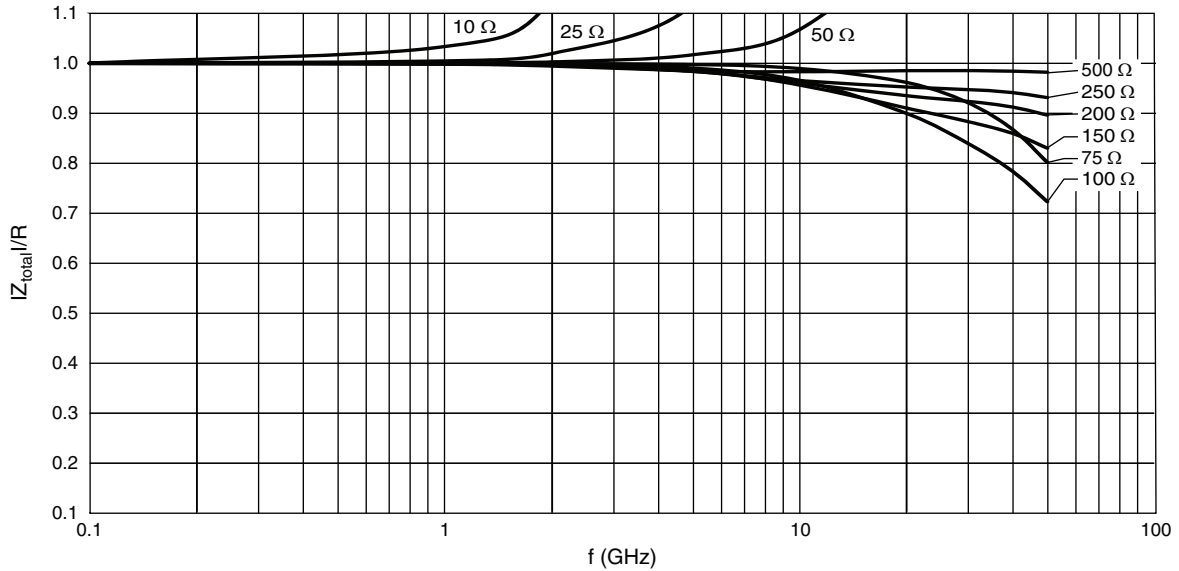

Internal impedance curve for 0402 size (N and G terminations)



INTERNAL IMPEDANCE CURVES ($|Z_{TOTAL}| / R$)

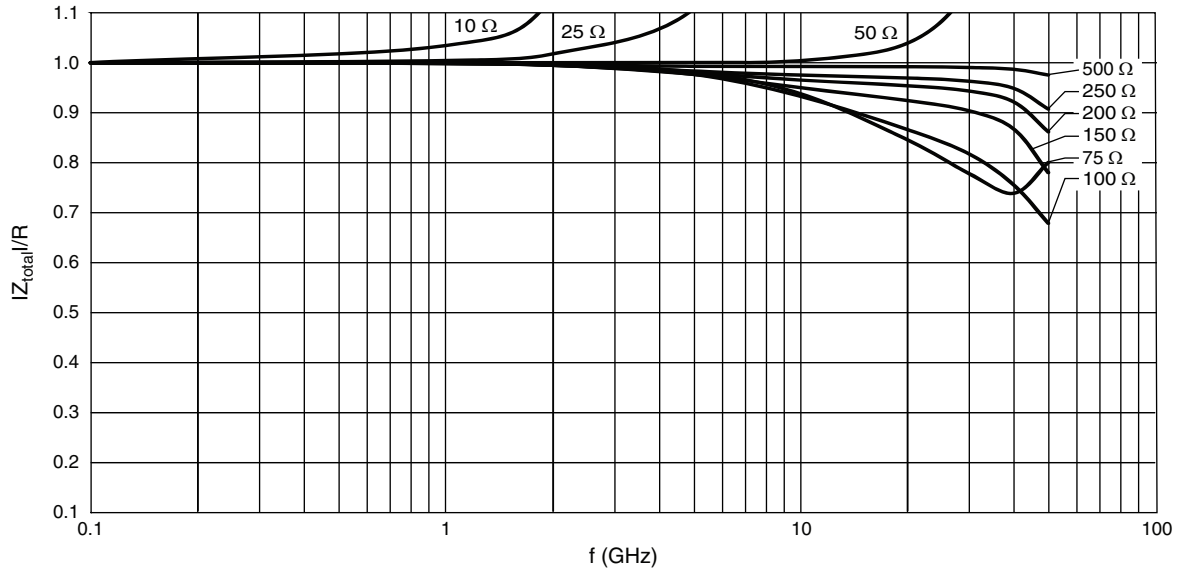

Internal impedance curve for 0603 size (F and P terminations)

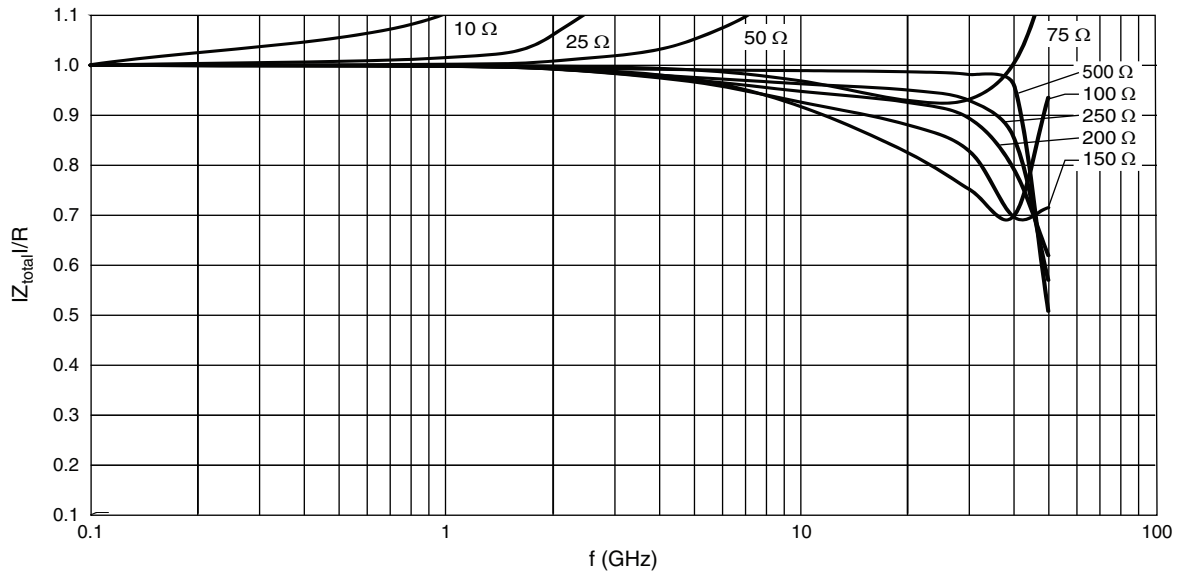

Internal impedance curve for 0603 size (N and G terminations)



S-PARAMETER

CH02016 (F and P Terminations)

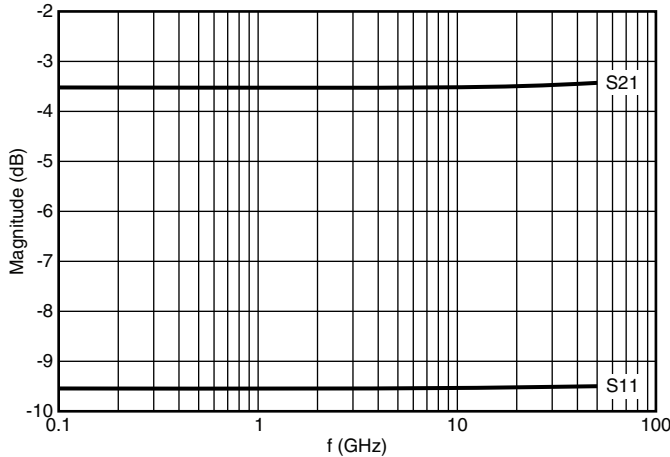

CH02016 flip chip ($Z_0 = Z_1 = Z_s = R = 50 \Omega$)

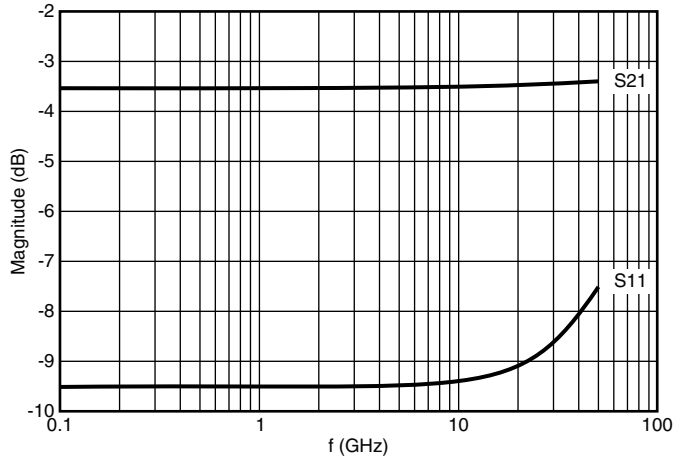

CH02016 flip chip ($Z_0 = Z_1 = Z_s = R = 100 \Omega$)

CH0402 (F and P Terminations)

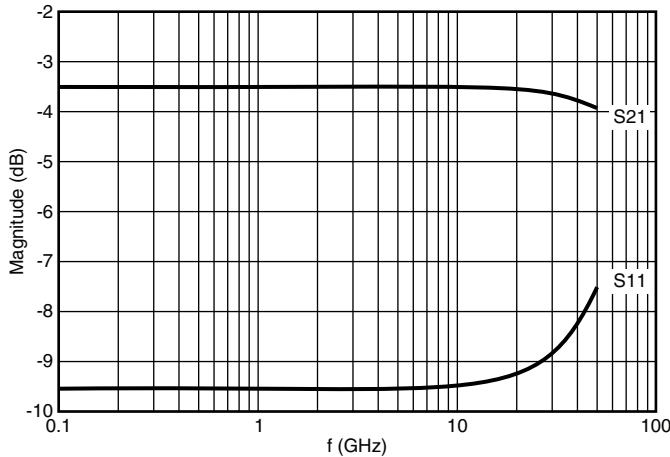

CH0402 flip chip ($Z_0 = Z_1 = Z_s = R = 50 \Omega$)

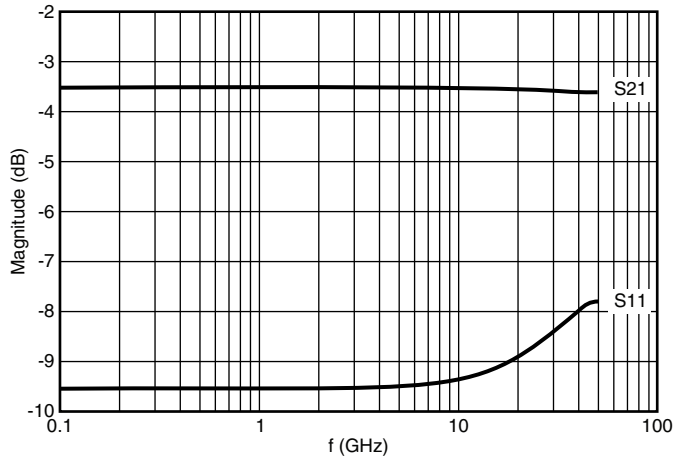

CH0402 flip chip ($Z_0 = Z_1 = Z_s = R = 100 \Omega$)

CH0402 (N and G Terminations)

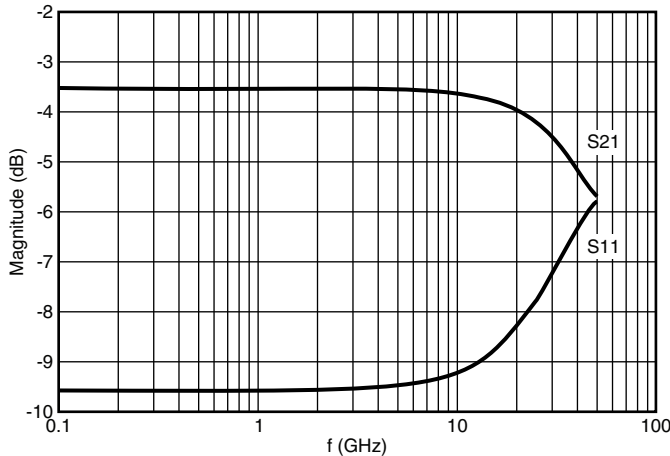

CH0402 wraparound ($Z_0 = Z_1 = Z_s = R = 50 \Omega$)

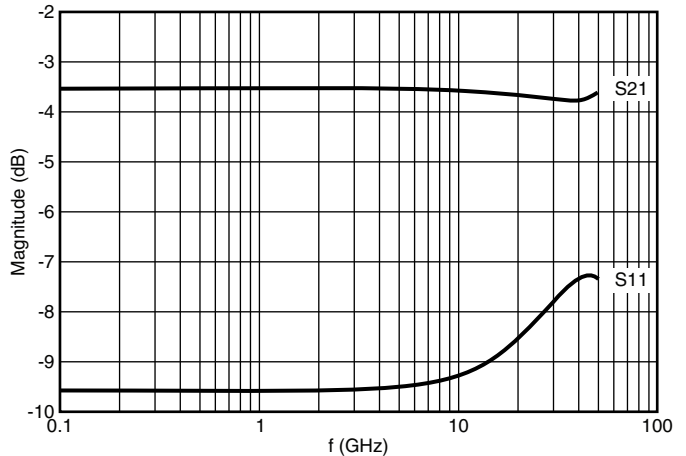

CH0402 wraparound ($Z_0 = Z_1 = Z_s = R = 100 \Omega$)



S-PARAMETER

CH0603 (F and P Terminations)

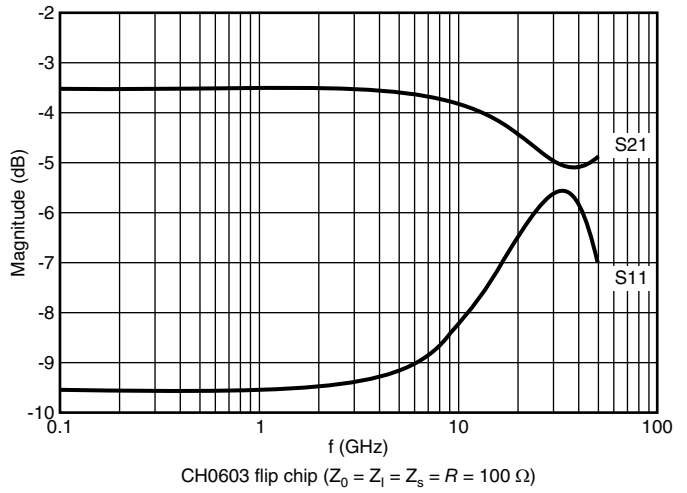
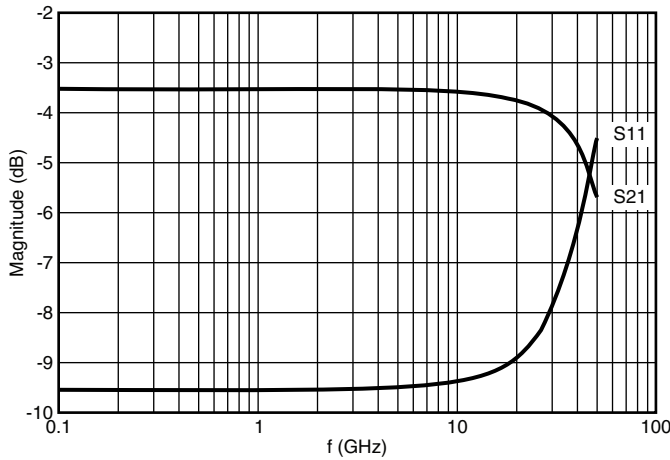

CH0603 (N and G Terminations)

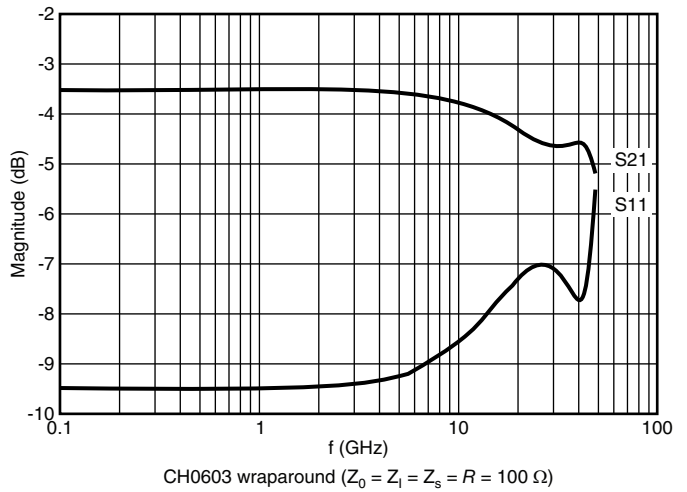
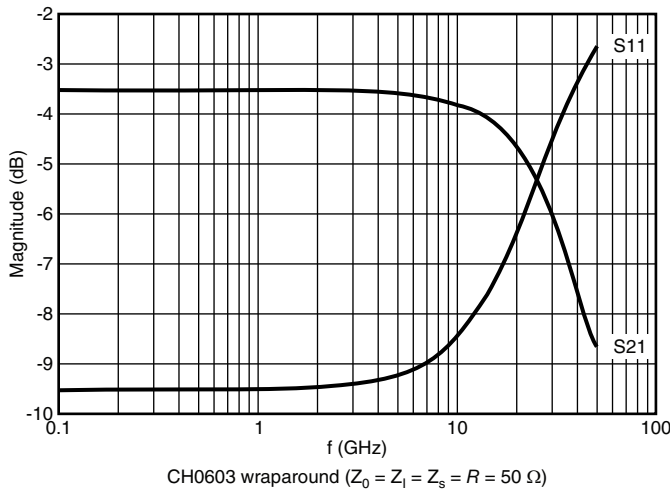



Disclaimer

ALL PRODUCT, PRODUCT SPECIFICATIONS AND DATA ARE SUBJECT TO CHANGE WITHOUT NOTICE TO IMPROVE RELIABILITY, FUNCTION OR DESIGN OR OTHERWISE.

Vishay Intertechnology, Inc., its affiliates, agents, and employees, and all persons acting on its or their behalf (collectively, "Vishay"), disclaim any and all liability for any errors, inaccuracies or incompleteness contained in any datasheet or in any other disclosure relating to any product.

Vishay makes no warranty, representation or guarantee regarding the suitability of the products for any particular purpose or the continuing production of any product. To the maximum extent permitted by applicable law, Vishay disclaims (i) any and all liability arising out of the application or use of any product, (ii) any and all liability, including without limitation special, consequential or incidental damages, and (iii) any and all implied warranties, including warranties of fitness for particular purpose, non-infringement and merchantability.

Statements regarding the suitability of products for certain types of applications are based on Vishay's knowledge of typical requirements that are often placed on Vishay products in generic applications. Such statements are not binding statements about the suitability of products for a particular application. It is the customer's responsibility to validate that a particular product with the properties described in the product specification is suitable for use in a particular application. Parameters provided in datasheets and / or specifications may vary in different applications and performance may vary over time. All operating parameters, including typical parameters, must be validated for each customer application by the customer's technical experts. Product specifications do not expand or otherwise modify Vishay's terms and conditions of purchase, including but not limited to the warranty expressed therein.

Except as expressly indicated in writing, Vishay products are not designed for use in medical, life-saving, or life-sustaining applications or for any other application in which the failure of the Vishay product could result in personal injury or death. Customers using or selling Vishay products not expressly indicated for use in such applications do so at their own risk. Please contact authorized Vishay personnel to obtain written terms and conditions regarding products designed for such applications.

No license, express or implied, by estoppel or otherwise, to any intellectual property rights is granted by this document or by any conduct of Vishay. Product names and markings noted herein may be trademarks of their respective owners.