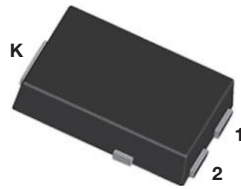
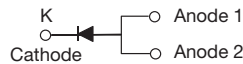


# High Current Density Surface Mount TMBS<sup>®</sup> (Trench MOS Barrier Schottky) Rectifier

 Ultra Low  $V_F = 0.28 \text{ V}$  at  $I_F = 5 \text{ A}$ 
**eSMP<sup>®</sup> Series**

**SMPC (TO-277A)**


## ADDITIONAL RESOURCES


[3D Models](#)

### PRIMARY CHARACTERISTICS

$I_{F(AV)}$	10 A
$V_{RRM}$	45 V
$I_{FSM}$	200 A
$V_F$ at $I_F = 10 \text{ A}$	0.35 V
$T_J$ max.	150 °C
Package	SMPC (TO-277A)
Circuit configuration	Single

## FEATURES

- Very low profile - typical height of 1.1 mm
- Ideal for automated placement
- Trench MOS Schottky technology
- Low forward voltage drop, low power losses
- High efficiency operation
- Meets MSL level 1, per J-STD-020, LF maximum peak of 260 °C
- Material categorization: for definitions of compliance please see [www.vishay.com/doc?99912](http://www.vishay.com/doc?99912)


**RoHS  
COMPLIANT  
HALOGEN  
FREE**

## TYPICAL APPLICATIONS

For use in low voltage high frequency DC/DC converters, freewheeling, and polarity protection applications.

## MECHANICAL DATA

**Case:** SMPC (TO-277A)

Molding compound meets UL 94 V-0 flammability rating Base P/N-M3 - halogen-free, RoHS-compliant, and commercial grade

**Terminals:** matte tin plated leads, solderable per J-STD-002 and JESD 22-B102

M3 suffix meets JESD 201 class 2 whisker test

### MAXIMUM RATINGS ( $T_A = 25 \text{ °C}$ unless otherwise noted)

PARAMETER	SYMBOL	V10PL45	UNIT
Device marking code		V10L45	
Maximum repetitive peak reverse voltage	$V_{RRM}$	45	V
Maximum DC forward current	$I_F^{(1)}$	10	A
	$I_F^{(2)}$	6.0	
Peak forward surge current 10 ms single half sine-wave superimposed on rated load	$I_{FSM}$	200	
Operating junction and storage temperature range (AC mode)	$T_J, T_{STG}$	-40 to +150	°C

#### Notes

(1) Mounted on 30 mm x 30 mm pad areas aluminum PCB

(2) Free air, mounted on recommended copper pad area

<b>ELECTRICAL CHARACTERISTICS</b> ( $T_A = 25\text{ }^\circ\text{C}$ unless otherwise noted)						
PARAMETER	TEST CONDITIONS	SYMBOL	TYP.	MAX.	UNIT	
Instantaneous forward voltage	$I_F = 5.0\text{ A}$	$T_A = 25\text{ }^\circ\text{C}$	$V_F^{(1)}$	0.39	-	V
	$I_F = 10\text{ A}$			0.44	0.52	
	$I_F = 5.0\text{ A}$	$T_A = 125\text{ }^\circ\text{C}$		0.28	-	
	$I_F = 10\text{ A}$			0.35	0.43	
Reverse current	$V_R = 45\text{ V}$	$T_A = 25\text{ }^\circ\text{C}$	$I_R^{(2)}$	-	5.0	mA
		$T_A = 125\text{ }^\circ\text{C}$		30	75	

**Notes**

- (1) Pulse test: 300  $\mu\text{s}$  pulse width, 1 % duty cycle  
 (2) Pulse test: Pulse width  $\leq 40\text{ ms}$

<b>THERMAL CHARACTERISTICS</b> ( $T_A = 25\text{ }^\circ\text{C}$ unless otherwise noted)			
PARAMETER	SYMBOL	V10PL45	UNIT
Typical thermal resistance	$R_{\theta JA}^{(1)}$	68	$^\circ\text{C/W}$
	$R_{\theta JM}^{(2)}$	4	

**Notes**

- (1) Free air, mounted on recommended copper pad area; thermal resistance  $R_{\theta JA}$  - junction-to-ambient  
 (2) Mounted on 30 mm x 30 mm aluminum PCB; thermal resistance  $R_{\theta JM}$  - junction-to-mount

<b>ORDERING INFORMATION</b> (Example)				
PREFERRED P/N	UNIT WEIGHT (g)	PREFERRED PACKAGE CODE	BASE QUANTITY	DELIVERY MODE
V10PL45-M3/86A	0.10	86A	1500	7" diameter plastic tape and reel
V10PL45-M3/87A	0.10	87A	6500	13" diameter plastic tape and reel

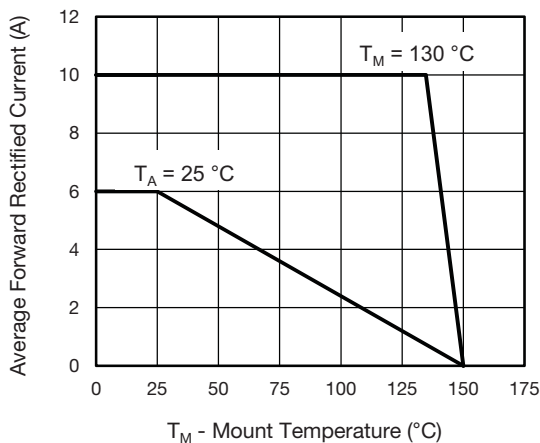
**RATINGS AND CHARACTERISTICS CURVES** ( $T_A = 25\text{ }^\circ\text{C}$  unless otherwise noted)


Fig. 1 - Maximum Forward Current Derating Curve

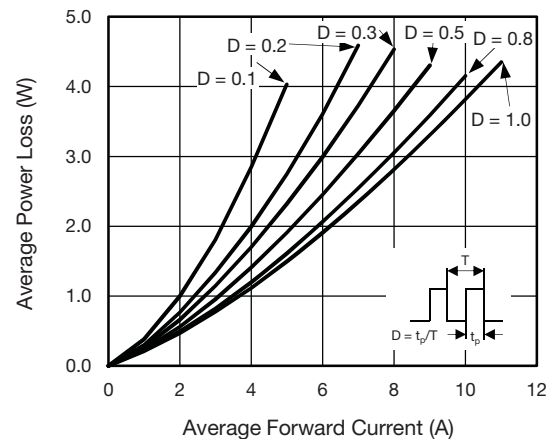


Fig. 2 - Forward Power Loss Characteristics

**Notes**

- (1) Mounted on 30 mm x 30 mm aluminum PCB;  $T_M$  measured at the terminal of cathode band ( $R_{\theta JM} = 4\text{ }^\circ\text{C/W}$ )  
 (2) Free air, mounted on recommended copper pad area ( $R_{\theta JA} = 68\text{ }^\circ\text{C/W}$ )

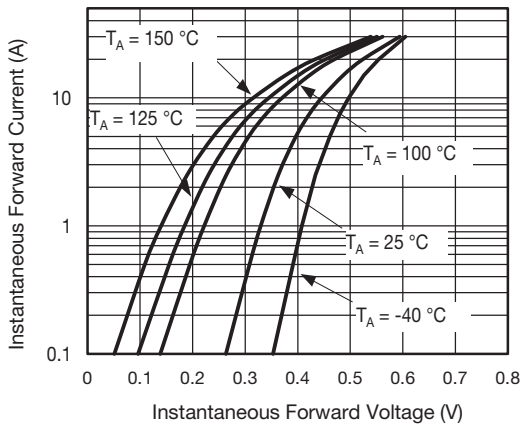


Fig. 3 - Typical Instantaneous Forward Characteristics

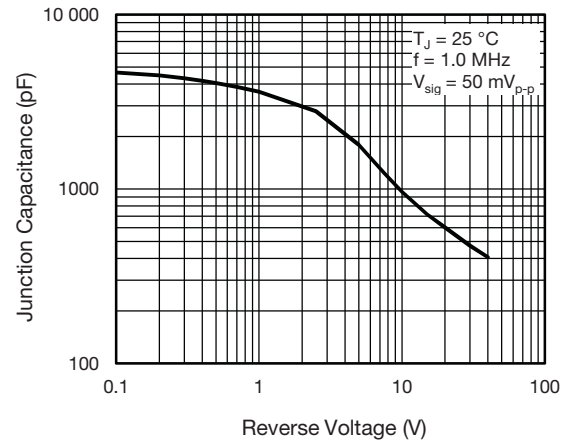


Fig. 5 - Typical Junction Capacitance

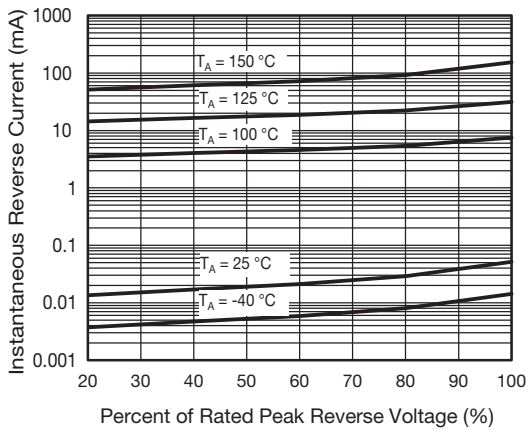


Fig. 4 - Typical Reverse Leakage Characteristics

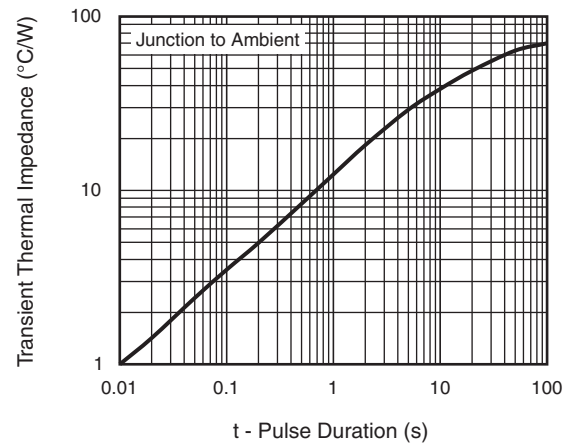
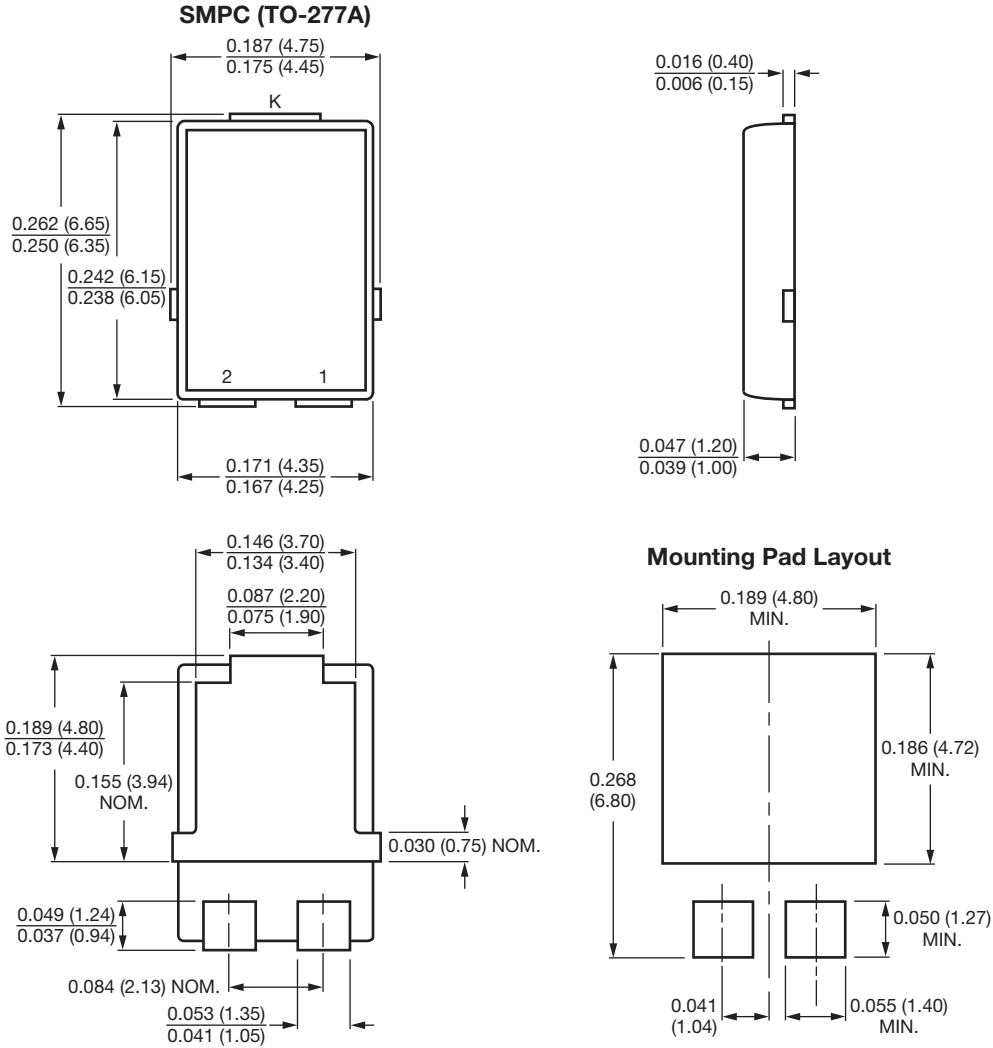


Fig. 6 - Typical Transient Thermal Impedance



PACKAGE OUTLINE DIMENSIONS in inches (millimeters)



Conform to JEDEC® TO-277A



## **Disclaimer**

ALL PRODUCT, PRODUCT SPECIFICATIONS AND DATA ARE SUBJECT TO CHANGE WITHOUT NOTICE TO IMPROVE RELIABILITY, FUNCTION OR DESIGN OR OTHERWISE.

Vishay Intertechnology, Inc., its affiliates, agents, and employees, and all persons acting on its or their behalf (collectively, "Vishay"), disclaim any and all liability for any errors, inaccuracies or incompleteness contained in any datasheet or in any other disclosure relating to any product.

Vishay makes no warranty, representation or guarantee regarding the suitability of the products for any particular purpose or the continuing production of any product. To the maximum extent permitted by applicable law, Vishay disclaims (i) any and all liability arising out of the application or use of any product, (ii) any and all liability, including without limitation special, consequential or incidental damages, and (iii) any and all implied warranties, including warranties of fitness for particular purpose, non-infringement and merchantability.

Statements regarding the suitability of products for certain types of applications are based on Vishay's knowledge of typical requirements that are often placed on Vishay products in generic applications. Such statements are not binding statements about the suitability of products for a particular application. It is the customer's responsibility to validate that a particular product with the properties described in the product specification is suitable for use in a particular application. Parameters provided in datasheets and / or specifications may vary in different applications and performance may vary over time. All operating parameters, including typical parameters, must be validated for each customer application by the customer's technical experts. Product specifications do not expand or otherwise modify Vishay's terms and conditions of purchase, including but not limited to the warranty expressed therein.

Except as expressly indicated in writing, Vishay products are not designed for use in medical, life-saving, or life-sustaining applications or for any other application in which the failure of the Vishay product could result in personal injury or death. Customers using or selling Vishay products not expressly indicated for use in such applications do so at their own risk. Please contact authorized Vishay personnel to obtain written terms and conditions regarding products designed for such applications.

No license, express or implied, by estoppel or otherwise, to any intellectual property rights is granted by this document or by any conduct of Vishay. Product names and markings noted herein may be trademarks of their respective owners.