

Long Life Cermet Potentiometer 2 Million Cycles

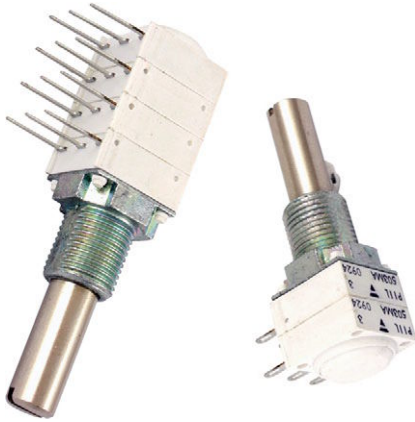

FEATURES

- 2 million cycles
- Cermet element
- 12.5 mm square single turn panel control
- 4, 6 and 6.35 shaft diameters and 29 terminal styles
- Multiple assemblies - up to four modules
- Test according to CECC 41000 or IEC 60393-1
- Low temperature coefficient
- Custom designs on request
- Linearity $\pm 3\%$ ($\pm 2\%$ available)
- Material categorization: for definitions of compliance please see www.vishay.com/doc?99912

RoHS
COMPLIANT

DESIGN SUPPORT TOOLS

[click logo to get started](#)
3D
Models
Available

QUICK REFERENCE DATA	
Multiple module	Up to 4 modules
Switch module	Yes
Detent module	Yes
Special electrical laws	A: linear, L: logarithmic, F: reverse logarithmic and others see specifications
Sealing level	IP 64
Lifespan	2M cycles

VERSATILE	MODULAR	COMPACT	ROBUST
-----------	---------	---------	--------

CONFIGURATION EXAMPLE - Dimensions in millimeters (inches) ± 0.5 mm (± 0.02 "

Single module, single shaft, vertical mounting, PC pins with support plate, metric bushing and shaft

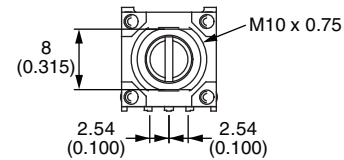
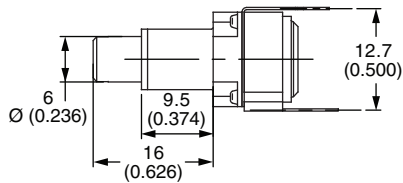

Dual modules, single shaft, PC pins with front support plates, imperial bushing and shaft

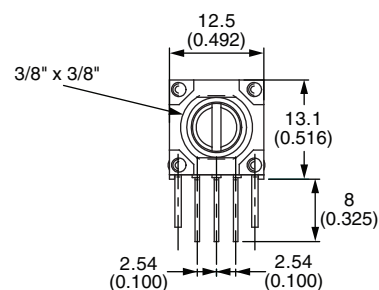
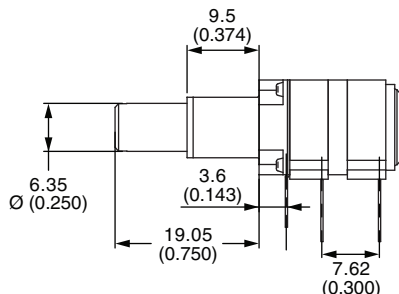

GENERAL SPECIFICATIONS

ELECTRICAL (initial)	
Resistive element	Cermet
Electrical travel	$270^\circ \pm 10^\circ$
Standard resistance values	1 k Ω , 5 k Ω , 10 k Ω , 50 k Ω
Tolerance	standard $\pm 20\%$ on request $\pm 5\%$ or $\pm 10\%$
Taper	
Circuit diagram	
Power rating at 70 °C	linear taper 0.1 W at +70 °C non-linear taper 0.05 W at +70 °C multiple assemblies 0.1 W at +70 °C per module
Temperature coefficient (typical)	± 150 ppm
Limiting element voltage	350 V
End resistance (typical)	2 Ω
Independent linearity	$\pm 3\%$ ($\pm 2\%$ available)
Insulation resistance	10 ⁶ M Ω min.
Dielectric strength	1500 V _{RMS} min.
Attenuation	-
Mechanical endurance	2 000 000 cycles

Note

- Nothing stated herein shall be construed as a guarantee of quality or durability



MECHANICAL (initial)	
Mechanical travel	300° ± 5°
Operating torque (typical) Single and dual assemblies Three to four modules (per module)	0.4 Ncm to 1.7 Ncm max. (0.57 oz.-inch to 2.55 oz.-inch max.) 0.2 Ncm to 0.3 Ncm max. (0.28 oz.-inch to 0.42 oz.-inch max.)
End stop torque 4 mm dia. shafts 6 mm and 1/4" dia. shafts	35 Ncm max. (2.9 lb.-inch max.) 80 Ncm max. (6.8 lb.-inch max.)
Tightening torque 7 mm dia. bushings 10 mm and 3/8" dia. bushings	150 Ncm max. (13 lb.-inch max.) 250 Ncm max. (21 lb.-inch max.)
Weight	7 g to 9 g per module (0.25 oz. to 0.32 oz.)

ENVIRONMENTAL	
Operating temperature range	-55 °C to +125 °C
Climatic category	55/125/56
Sealing	IP64

MARKING
<ul style="list-style-type: none"> • Potentiometer module Vishay logo, SAP code of ohmic value, and tolerance in %, identify P11L version, variation law, manufacturing date (four digits), "3" for the lead 3 • Switch module Version, manufacturing date (four digits), "c" for common lead

PACKAGING
<ul style="list-style-type: none"> • Box

PERFORMANCES				
TESTS	CONDITIONS	TYPICAL VALUES AND DRIFTS		
		$\Delta R_T/R_T$ (%)	$\Delta R_{1-2}/R_{1-2}$ (%)	OTHER
Electrical endurance	1000 h at rated power 90°/30° - ambient temp. 70 °C	± 2 %	-	-
Climatic sequence	Dry heat at +125 °C/damp heat cold -55 °C/damp heat, 5 cycles	± 1 %	-	-
Damp heat, steady state	+40 °C, 93 % relative humidity 56 days	± 2 %	-	Insulation resistance: > 1000 MΩ
Change of temperature	-55 °C to +125 °C, 5 cycles	± 0.2 %	-	-
Mechanical endurance	2 million cycles turn angle: ± 60° temperature: 20 °C	± 20 %	-	Independent linearity: ± 10 %
Shock	50 g's, 11 ms 3 shocks - 3 directions	± 0.2 %	± 0.5 %	-
Vibration	10 Hz to 55 Hz 0.75 mm or 10 g's, 6 h	± 0.2 %	-	$\Delta V_{1-2}/V_{1-3} = \pm 0.5 \%$



ORDERING INFORMATION (part number)																	
P	1	1	L	2	F	A	G	O	S	Y	0	0	5	0	2	K	A
MODEL	NUMBER OF MODULES	BUSHING	LOCATING PEG	SHAFT	SHAFT STYLE	LEADS	RESISTANCE CODE/TOLERANCE/TAPER OR SPECIAL										
P11L	1 2 3 4																

STANDARD RESISTANCE ELEMENT DATA				
STANDARD RESISTANCE VALUES	LINEAR TAPER		NON-LINEAR TAPER	
	MAX. POWER AT 70 °C	MAX. WORKING VOLTAGE	MAX. POWER AT 70 °C	MAX. WORKING VOLTAGE
Ω	W	V	W	V
1K	0.1	10.0	0.05	7.1
5K	0.1	22.4	0.05	15.8
10K	0.1	31.6	0.05	22.4
50K	0.1	70.7	0.05	50.0

ORDERING INFORMATION (part number)																														
P	1	1	L	2	F	A	G	O	S	Y	0	0	5	0	2	K	A													
MODEL	NUMBER OF MODULES			BUSHING			LOCATING PEG	SHAFT	SHAFT STYLE	LEADS	RESISTANCE CODE/ TOLERANCE/ TAPER OR SPECIAL																			
				<table border="1" style="margin: auto; border-collapse: collapse;"> <tr> <td style="width: 20px;"></td> <td style="text-align: center;">Ø</td> <td style="text-align: center;">L</td> </tr> <tr> <td style="text-align: center;">F</td> <td style="text-align: center;">3/8"</td> <td style="text-align: center;">3/8"</td> </tr> <tr> <td style="text-align: center;">Q</td> <td style="text-align: center;">7</td> <td style="text-align: center;">8</td> </tr> <tr> <td style="text-align: center;">V</td> <td style="text-align: center;">10</td> <td style="text-align: center;">9.5</td> </tr> </table>			Ø	L	F	3/8"	3/8"	Q	7	8	V	10	9.5													
	Ø	L																												
F	3/8"	3/8"																												
Q	7	8																												
V	10	9.5																												

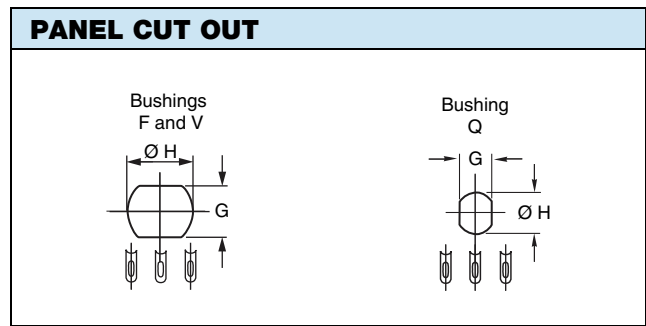
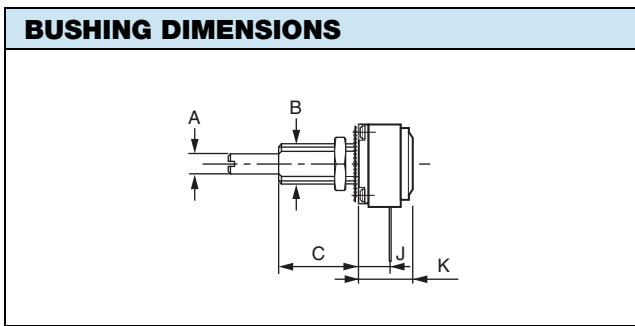

BUSHINGS				mm (± 0.5)	mm (± 0.5)	INCHES (± 0.02)
				V	Q	F
A	Shafts	Ø	6	4	1/4	
B	Bushing	Ø	10	7	3/8	
C		L	9.5	8	3/8	
J	Lead versions X.. Y..		7	5	0.278	
	K		11.1	9.1	0.436	
G	Panel		8.2	6.2	0.323	
H	Cutout	Ø	10.5	7.5	0.394	
	Thread		0.75	0.75	32 thread/inch	
	Wrench nut		12	10	0.500	

Note

- Hardware supplied in separate bags

ORDERING INFORMATION (part number)

P	1	1	L	2	F	A	G	O	S	Y	0	0	5	0	2	K	A	
MODEL	NUMBER OF MODULES		BUSHING	LOCATING PEG			SHAFT	SHAFT STYLE	LEADS	RESISTANCE CODE/ TOLERANCE/ TAPER OR SPECIAL								
				A = see table B = below C = 0 = without peg														

LOCATING PEGS (anti-rotation lug)

The locating peg is provided by a plate mounted on the bushing and positioned by the module sides. Four set positions are available, clock face orientation: 12, 3, 6, 9.

All P11 bushings have a double flat. When panel mounting holes have been punched accordingly, an anti-rotation lug is not necessary.

Locating peg code C not available for bushing Q.

CODE	Ø d (mm)	L (mm)	e (mm)
A	2	6.2	0.7
B	2	7.75	0.7
C	3.5	13.5	1.1

Locating pegs are supplied in separate bags with nuts and washers

ORDERING INFORMATION (part number)																	
P	1	1	L	2	F	A	G	O	S	Y	0	0	5	0	2	K	A
MODEL	NUMBER OF MODULES	BUSHING	LOCATING PEG	SHAFT				SHAFT STYLE	LEADS	RESISTANCE CODE/TOLERANCE/TAPER OR SPECIAL							
					Ø	L		S = slotted R = round F = flatted D = custom									
				AP = Custom shaft													
				EA	4	9.5											
				EB	4	12.5											
				EJ	4	22											
				FG	6	16											
				FL	6	25											
				FR	6	50											
				GG	1/4"	5/8"											
				GH	1/4"	3/4"											
				GJ	1/4"	7/8"											
				GL	1/4"	1"											
				GO	1/4"	1.5"											

SHAFTS - Dimensions in millimeters (inches)

The shaft length is always measured from the mounting face. Standard shafts are designed by a 3 letters code (3 digits). Shaft slots and flats are aligned with the wiper position ($\pm 10^\circ$); picture shows shaft with wiper at middle of mechanical/electrical course.

All standard shafts are slotted except flatted and splined, see exceptions for bushing.

FLATTED SHAFT

Bushing: F
Shaft: GHF

SPLINED SHAFT

Bushing: Q
Shaft: FHK
Ø 7

CUSTOM SHAFTS

When special shafts are required - flat, threaded ends, special shaft lengths, etc. a drawing is required.

STANDARD COMBINATION OF SHAFT STYLES AND BUSHINGS							
SHAFT DIA.	BUSHING CODE	SHAFT LENGTH AND STYLE AVAILABLE IN STANDARD (others on request)					
6	V	FGS	FLS	FRS			
6.35	F	GGs	GHS	GJS	GLS	GOS	GHF
4	Q	EAS	EBS	EJS	FHK		

ORDERING INFORMATION (part number)																	
P	1	1	L	2	F	A	G	O	S	Y	0	0	5	0	2	K	A
MODEL	NUMBER OF MODULES	BUSHING	LOCATING PEG	SHAFT	SHAFT STYLE	LEADS						RESISTANCE CODE/TOLERANCE/TAPER OR SPECIAL					
						Available leads											
						A00 W00 X00 Y00 Z00											
						A10 W10 X03 Y03 Z03											
						A13 W20 X04 Y04 Z04											
						A14 X10 Z10											
						A20 X13 Z13											
						A23 X14 Z14											
						A24 X20 Z20											
						X23 Z23											
						X24 Z24											

FIRST DIGIT		SECOND DIGIT		THIRD DIGIT	
Y	Soldering lugs	0	Y = 4.65 (0.183") A, X, Z, W = 5.08 (0.200") pin spacing pins section 0.9 x 0.3 (0.035" x 0.012")	0	5.08 (0.200") space between modules
X	PCB pins	1	2.54 (0.100") pin spacing pin section 0.6 x 0.3 (0.024" x 0.012")	3	7.62 (0.300") space between modules
Z	PCB pins with front support plate	2	5.08 (0.200") pin spacing pins section 0.6 x 0.3 (0.024" x 0.012")	4	10.16 (0.400") space between modules
A	PCB pins with front and back support plates				
W	PCB pins - vertical mounting with 2 extra pins - 1 module only				

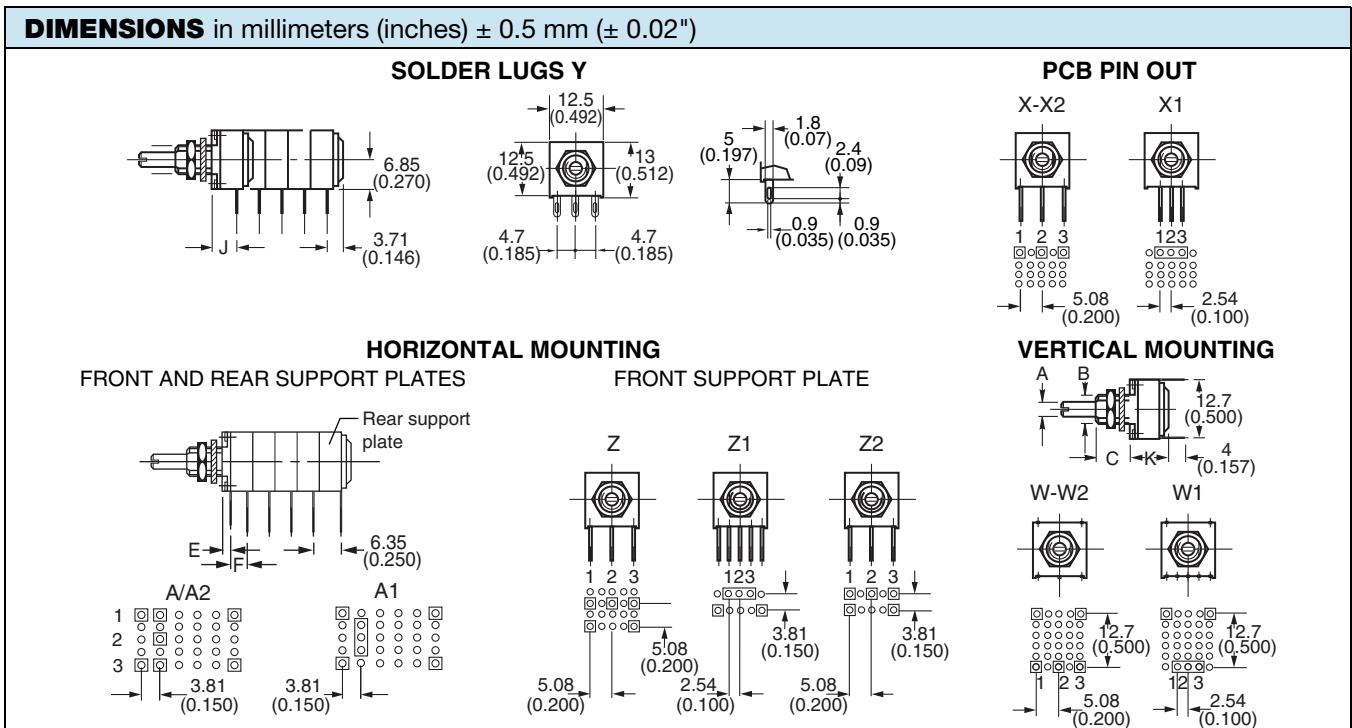

THE POSITION OF EACH MODULE IS FREE

BUSHINGS	MILLIMETERS (± 0.5)		INCHES (± 0.02)
	V	Q	F
E Leads Z00	3.85	1.85	0.150
E Leads Z1, Z2, A..	3.6	1.6	0.140
F	Leads Z0: 5.08 (0.200")		Leads A...Z1, Z2: 3.81 (0.150")
J Leads X.. Y..	7	5	0.278

ORDERING INFORMATION (part number)																	
P	1	1	L	2	F	A	G	O	S	Y	0	0	5	0	2	K	A
MODEL	NUMBER OF MODULES	BUSHING	LOCATING PEG	SHAFT	SHAFT STYLE	LEADS	RESISTANCE CODE/ TOLERANCE/ TAPER OR SPECIAL										
							Resistance code: 1K = 102 5K = 502 10K = 103 50K = 503 Tolerance code: standard: M = ± 20 % on request: K = ± 10 %, J = ± 5 % Taper: A, L, F or special code given by Vishay										

SPECIAL CODES GIVEN BY VISHAY
Option available: <ul style="list-style-type: none"> • Custom shaft • Specific design on request • Specific linearity • Multiple assemblies with various modules

APPLICATION NOTE	
<p>The potentiometer shall be used in voltage divider with an impedance load at least 100 times higher than the total potentiometer nominal resistance value.</p> <p>Advised load impedance: 1 MΩ min. for resistance range of 1 kΩ to 50 kΩ</p>	

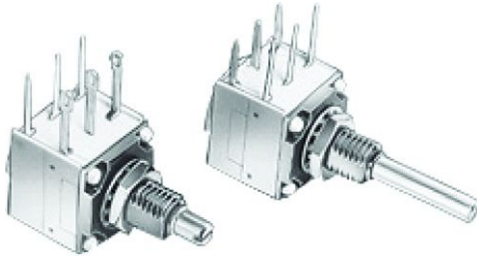
P11L OPTION: ROTARY SWITCH MODULES

- Rotary switch
- Current up to 2 A
- Actuation CW or CCW position
- Sealing IP60

**MODULES: RS ON/OFF SWITCH
RSI CHANGEOVER SWITCH**

The position of each module is free.

RS and RSI rotary switches are housed in a standard P11L module size 12.7 mm x 12.7 mm x 5.08 mm (0.5" x 0.5" x 0.2"). They have the same terminal styles as the assembled electrical modules.

An assembly can comprise 1 or more switch modules.

Switch actuation is described as seen from the shaft end.

D: Means actuation in maximum CCW position

F: Means actuation in maximum CW position

The switch actuation travel is 25° with a total mechanical travel of 300° ± 5° and electrical travel of electrical modules is 238° ± 10°.

Leads finish: Gold plated

RDS SINGLE POLE SWITCH, NORMALLY OPEN

In full CCW position, the contact between 1 and 3 is open. It is made at the beginning of the travel in CW direction.

RSF SINGLE POLE SWITCH, NORMALLY OPEN

In full CW position, the contact between 1 and 3 is open. It is made at the beginning of the travel in CCW direction.

RSID SINGLE POLE CHANGEOVER

In full CCW position, the contact is made between 3 and 2 and open between 3 and 1. Switch actuation (CW direction) reverses these positions.

RSIF SINGLE POLE CHANGEOVER

In full CW position, the contact is made between 1 and 2 and open between 1 and 3. Switch actuation (CCW direction) reverses these positions.

SWITCH SPECIFICATIONS

Switching power maximum	0.5 VA =	
Switching current maximum	0.1 A, 5 V =	
Maximum current through element	2 A	
Contact resistance	100 mΩ	
Dielectric strength	Terminal to terminal	1000 V _{RMS}
	Terminal to bushing	2000 V _{RMS}
Maximum voltage operation	5 V =	
Insulation resistance between contacts	10 ⁶ MΩ	
Life at P _{max.}	100 000 actuations	
Minimal travel	25°	
Operating temperature	-40 °C to +85 °C	

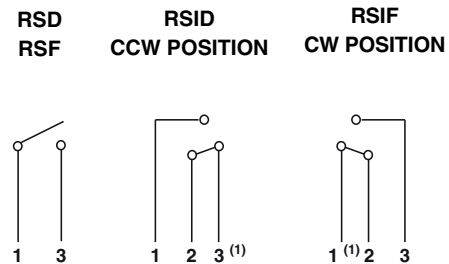
ELECTRICAL DIAGRAM

Note

(1) Common

ORDERING INFORMATION (First order only)

RSID

RSD	SPST: Single pole, open switch in CCW position - 2 pins
RSF	SPST: Single pole, open switch in CW position - 2 pins
RSID	SPDT: Single pole, changeover switch in CCW position - 3 pins
RSIF	SPDT: Single pole, changeover switch in CW position - 3 pins

P11L OPTION: DETENT MODULES

The detents mechanism is housed in a standard P11L module. Up to 21 detent positions available.

Count detents as follows: 1 for CCW position, 1 for full CW position, plus the other positions forming equal resistance increments (linear taper) - not equal angles.

Available: CVID - CVIF - CVIM
CV3 - CV11 - CV21

Mechanical endurance: 50 000 cycles

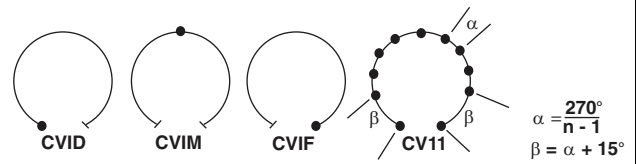

ORDERING INFORMATION (First order only for special code creation)

CV1M

- CV1M** 1 detent at half travel
- CV1D** 1 detent at CCW position
- CV1F** 1 detent at CW position
- CV3** 3 detents
- CV11** 11 detents
- CV21** 21 detents

P11L OPTION: NEUTRAL MODULES "EN"

Neutral or screen module is housed in a standard P11L module. It is used as a screen between two electrical modules.

The leads can be connected to ground.

ORDERING INFORMATION (First order only for special code creation)

EN

- EN** Neutral module

P11L OPTION: SPECIAL LINEARITY - CONFORMITY

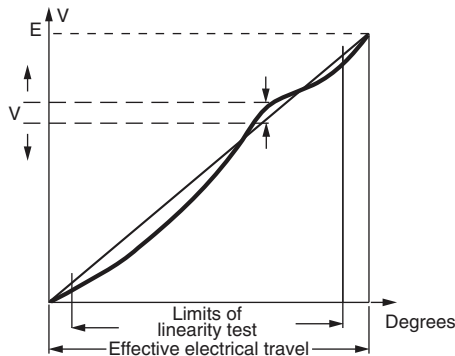

The independent linearity (conformity for the non-linear laws) is the maximum gap ΔV between the actual variation curve and the theoretical variation curve the nearest to it. The linearity and the conformity are expressed in percentage of the total applied voltage E

$$\text{linearity conformity} = \frac{\pm \Delta V_{\max}}{E}$$

They are measured over 90 % of actual electrical travel (centered).

On request linearity can be guaranteed in linear taper.

ORDERING INFORMATION (First order only)

J123

- J123** Independent linearity $\pm 3\%$ (linear law)
- J145** Independent linearity $\pm 2\%$ (linear law)

For other request, contact us.



EXAMPLES OF FIRST ORDER INFORMATION

FIRST EXAMPLE: Triple module (switch is counted as a module)

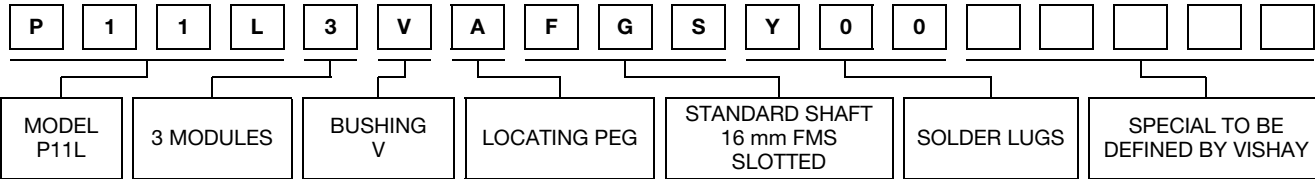

ORDERING INFORMATION:

PART NUMBER	P11L3VAFGSY00.....	
SHAFT AND BUSHING	See drawing of special shaft attached	
MODULE NO. 1	503 M A	
MODULE NO. 2	103 M A	J123
MODULE NO. 3	503 M A	

PART NUMBER DESCRIPTION (used on some Vishay document or label, for information only)

P11L	3	V	A	FG	S	Y00				T1927		e3
MODEL	MODULES	BUSHING	LOCATING PEG	SHAFT	SHAFT STYLE	LEADS	VALUE	TOL.	TAPER	SPECIAL	SPECIAL	LEAD (Pb)-FREE

RELATED DOCUMENTS

APPLICATION NOTES	
Potentiometers and Trimmers	www.vishay.com/doc?51001
Guidelines for Vishay Sfernice Resistive and Inductive Components	www.vishay.com/doc?52029



Disclaimer

ALL PRODUCT, PRODUCT SPECIFICATIONS AND DATA ARE SUBJECT TO CHANGE WITHOUT NOTICE TO IMPROVE RELIABILITY, FUNCTION OR DESIGN OR OTHERWISE.

Vishay Intertechnology, Inc., its affiliates, agents, and employees, and all persons acting on its or their behalf (collectively, "Vishay"), disclaim any and all liability for any errors, inaccuracies or incompleteness contained in any datasheet or in any other disclosure relating to any product.

Vishay makes no warranty, representation or guarantee regarding the suitability of the products for any particular purpose or the continuing production of any product. To the maximum extent permitted by applicable law, Vishay disclaims (i) any and all liability arising out of the application or use of any product, (ii) any and all liability, including without limitation special, consequential or incidental damages, and (iii) any and all implied warranties, including warranties of fitness for particular purpose, non-infringement and merchantability.

Statements regarding the suitability of products for certain types of applications are based on Vishay's knowledge of typical requirements that are often placed on Vishay products in generic applications. Such statements are not binding statements about the suitability of products for a particular application. It is the customer's responsibility to validate that a particular product with the properties described in the product specification is suitable for use in a particular application. Parameters provided in datasheets and / or specifications may vary in different applications and performance may vary over time. All operating parameters, including typical parameters, must be validated for each customer application by the customer's technical experts. Product specifications do not expand or otherwise modify Vishay's terms and conditions of purchase, including but not limited to the warranty expressed therein.

Except as expressly indicated in writing, Vishay products are not designed for use in medical, life-saving, or life-sustaining applications or for any other application in which the failure of the Vishay product could result in personal injury or death. Customers using or selling Vishay products not expressly indicated for use in such applications do so at their own risk. Please contact authorized Vishay personnel to obtain written terms and conditions regarding products designed for such applications.

No license, express or implied, by estoppel or otherwise, to any intellectual property rights is granted by this document or by any conduct of Vishay. Product names and markings noted herein may be trademarks of their respective owners.