

Thin Film Resistor Network Military, MIL-PRF-83401 Qualified, Type RZ070, RZ080, RZ090, RZ210, RZ220, RZ230, Single-In-Line SIP

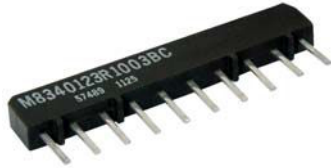

Qualified to meet MIL-PRF-83401 characteristic “R”, “V”, and “H”

These resistor networks are available in 6 pins, 8 pins, and 10 pins in schematic C and G styles. Custom circuits are not available. Schematic C and G only. They incorporate Vishay Dale Thin Film’s patented passivated nichrome film to give superior performance on temperature coefficient of resistance, thermal stability, noise, voltage coefficient, power handling and resistance stability. The leads are attached to the metallized alumina substrates by Thermo-Compression bonding. The body is molded thermoset plastic with gold plated copper alloy leads. This product will outperform all of the requirements of characteristic “R”, “V”, and “H” of MIL-PRF-83401.

SCHEMATIC

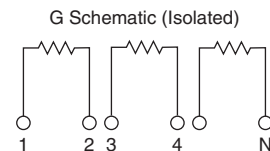
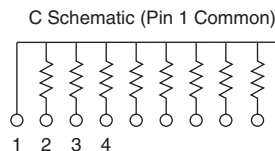

FEATURES

- MIL-PRF-83401 qualified (cage code 57489)
- Low Profile 0.195" (4.95 mm seated height)
- Characteristics R (± 25 ppm), H, V, K, and M
- Hot fused tin/lead 60/40 solder dipped
- Rugged molded low profile construction with standoff
- 100 % screened to groups A MIL-PRF-83410 testing
- Tolerances to 0.1 %
- Isolated and bussed (schematic C and G)

TYPICAL PERFORMANCE

	ABSOLUTE	TRACKING
TCR	25	5
	ABSOLUTE	RATIO
TOL.	0.1	0.1 to 0.05

STANDARD ELECTRICAL SPECIFICATIONS		
TEST	SPECIFICATIONS	CONDITIONS
Material	Passivated nichrome	-
Pin/Lead Number	6, 8, 10	-
Resistance Range	100 Ω to 200 k Ω per resistor	Tolerance dependent ⁽²⁾
TCR: Absolute	± 25 ppm/ $^{\circ}$ C to 300 ppm/ $^{\circ}$ C	- 55 $^{\circ}$ C to + 125 $^{\circ}$ C ⁽¹⁾
TCR: Tracking	± 5 ppm/ $^{\circ}$ C	- 55 $^{\circ}$ C to + 125 $^{\circ}$ C
Tolerance: Absolute	± 0.1 % to ± 5.0 %	+ 25 $^{\circ}$ C
Tolerance: Ratio	± 0.1 % to R ₁	+ 25 $^{\circ}$ C
Power Rating: Resistor	0.06 mW to 0.120 mW (per element typical at + 25 $^{\circ}$ C) ⁽¹⁾	Maximum at + 70 $^{\circ}$ C
Power Rating: Package	0.18 W to 1.08 W ⁽¹⁾	Maximum at + 70 $^{\circ}$ C
Stability: Absolute	$\Delta R \pm 0.05$ %	2000 h at + 70 $^{\circ}$ C
Stability: Ratio	$\Delta R \pm 0.015$ %	2000 h at + 70 $^{\circ}$ C
Voltage Coefficient	< 0.1 ppm/V	-
Working Voltage	100 V	-
Operating Temperature Range	- 55 $^{\circ}$ C to + 125 $^{\circ}$ C	-
Storage Temperature Range	- 55 $^{\circ}$ C to + 125 $^{\circ}$ C	-
Noise	< - 30 dB	-
Thermal EMF	< 0.08 μ V/ $^{\circ}$ C	-
Shelf Life Stability: Absolute	$\Delta R \pm 0.01$ %	1 year at + 25 $^{\circ}$ C
Shelf Life Stability: Ratio	$\Delta R \pm 0.002$ %	1 year at + 25 $^{\circ}$ C

Notes

⁽¹⁾ Consult MIL-PRF-83401

⁽²⁾ “H” characteristic 100 Ω to 100 k Ω resistance range at 0.1% best
 “R” characteristic 250 Ω to 100 k Ω resistance range at 0.1% best
 “R” characteristic 250 Ω to 200 k Ω resistance range at 1% best

DIMENSIONS AND IMPRINTING in inches and millimeters

	DIMENSION	INCHES	MILLIMETERS
	A	0.035	0.89
B	0.040	1.02	
C	0.100 ± 0.005 non-accum.	2.54 ± 0.13	
D	0.019 ± 0.006 typical	0.48 ± 0.15	
E	0.187 ± 0.010	4.75 ± 0.25	
F	0.135	3.43	
G	0.095	2.41	
H	0.012 ± 0.004	0.31 ± 0.10	
L (6 Pins)	0.583 - 0.023/+ 0.01	14.81 - 0.584/+ 0.254	
L (8 Pins)	0.783 - 0.023/+ 0.01	19.89 - 0.584/+ 0.254	
L (10 Pins)	0.983 - 0.023/+ 0.01	24.97 - 0.584/+ 0.254	

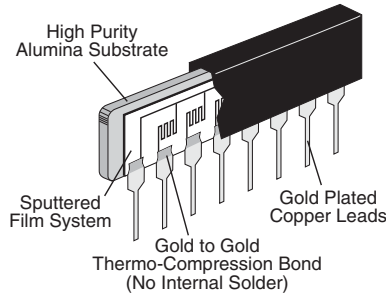
CONSTRUCTION

MECHANICAL SPECIFICATIONS

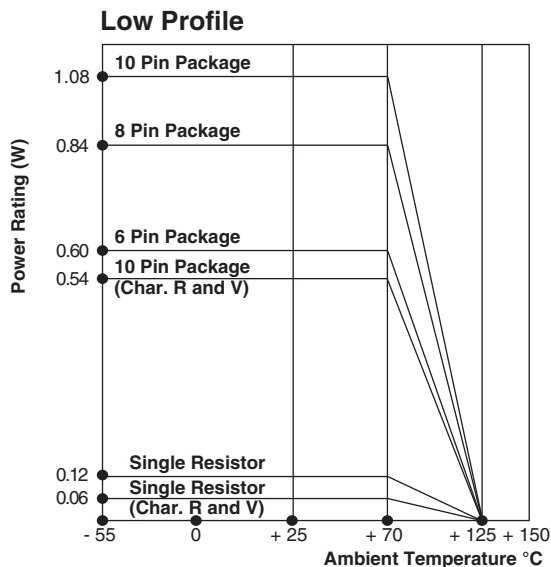
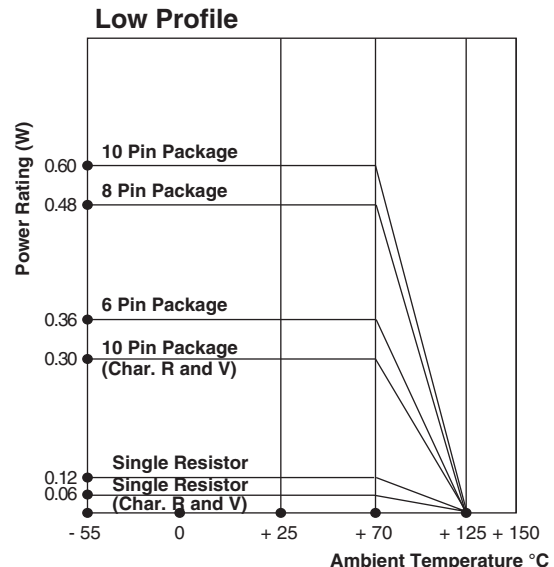
Resistive Element	TAMELOX passivated nichrome
Substrate Material	Alumina
Body Molded	Epoxy
Terminals	Copper alloy
Plating/Solder	Nickel/gold/Sn63 fussed

POWER DERATING
C Schematic (Pin 1 Common Characteristic H)

G Schematic (Isolated Characteristic H)



GLOBAL PART NUMBER INFORMATION																	
New Global Part Numbering: M8340107H1000BCUF																	
M	8	3	4	0	1	0	7	H	1	0	0	0	B	C	U	F	V
MODEL (5 digits)	SCHEMATIC (2 digits)		CHARACTERISTIC (1 digit)		RESISTANCE (4 digits)			TOLERANCE (1 digit)		SCHEMATIC (1 digit)		PACKAGING (2 digits)		VENDOR (1 digit)			
M83401 Single in-line resistor network low profile C83401 Non burn in screened network	07 = 6 pin 08 = 8 pin 09 = 10 pin 21 = 6 pin ⁽¹⁾ 22 = 8 pin ⁽¹⁾ 23 = 10 pin ⁽¹⁾		H = 50 ppm/°C V = 50 ppm/°C 5 ppm/°C track R = 25 ppm/°C 5 ppm/°C track K = 100 ppm/°C M = 300 ppm/°C		First 3 digits are significant figures and the last digit specifies the number of zeros to follow. (100 Ω to 100 kΩ) Examples: 1000 = 100 Ω 1001 = 1000 Ω			B = 0.1 % ⁽³⁾ D = 0.5 % ⁽³⁾ F = 1 % G = 2 % J = 5 %		C = Pin 1 common G = Isolated resistors		UF = Tubed UI = 100 min., 1 mult (item single lot date code) UP = 100 min., 1 mult (package unit single lot date)		V ⁽²⁾ = Vishay Dale Thin Film			

Notes

- (1) No internal solder
- (2) "V" is not required for characteristics R, H, and V, it is only required for K and M. Characteristics tolerance equal to or greater than 1 %."
- (3) "H" characteristic 100 Ω to 100 kΩ resistance range at 0.1% best
 "R" characteristic 250 Ω to 100 kΩ resistance range at 0.1% best
 "R" characteristic 250 Ω to 200 kΩ resistance range at 1% best

MODEL	SCHEMATIC	CHARACTERISTIC	RESISTANCE RANGE	TOLERANCE	SCHEMATIC
M83401 C83401	07 = 6 pin (RZ070) 08 = 8 pin (RZ080) 09 = 10 pin (RZ090) 21 = 6 pin (RZ210) 22 = 8 pin (RZ220) 23 = 10 pin (RZ230)	H = 50 ppm/°C	100 to 100K	B, D, F, G, J	C, G
		V = 50 ppm/°C/ 5 ppm/°C track	250 to 100K	B, D, F, G, J	
			250 to 200K	F, G, J	
		R = 25 ppm/°C 5 ppm/°C track	250 to 100K	B, D, F, G, J	
			250 to 200K	F, G, J	
		K = 100 ppm/°C	100 to 100K	B, D, F, G, J	
M = 300 ppm/°C					



Vishay Dale Thin Film Land Patterns

1. Scope

This technical note provides sample land patterns for Vishay Dale Thin Film SMT resistive products. The following drawings are based on IPC-SM-782 Surface Mount Design and Land Pattern Standard. These drawings are for reference only Vishay Thin Film recommends that the user contacts their PC board supplier for actual land patterns required. The pads are intended for lead (Pb)-free and tin / lead solder types.

2. Product Series

Thin Film Surface Mount Chip Resistors (FC, L, P, PTN, PLT, PLTT, PLTU, PAT, PATT, PNM, M/D55342 QPL Series)

0402 Land Pattern

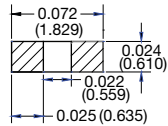

0502 Land Pattern

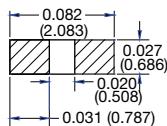

0505 Land Pattern

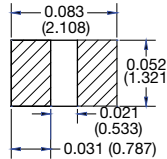

0603 Land Pattern

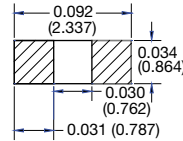

0705 Land Pattern

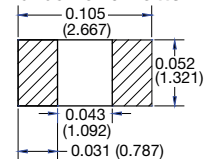

1005 Land Pattern

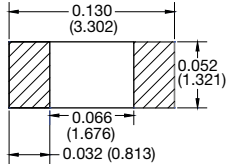

1010 Land Pattern

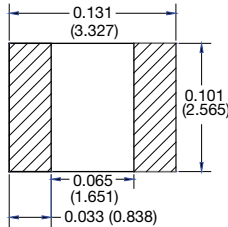

1206 Land Pattern

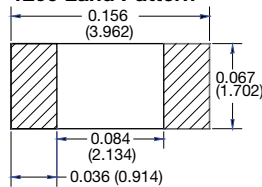

1505 Land Pattern

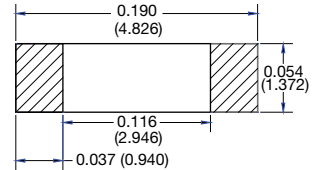

2010 Land Pattern

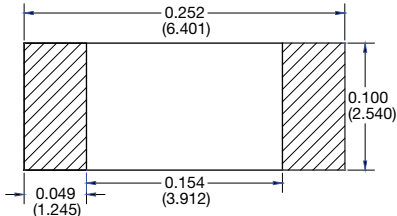

2208 Land Pattern

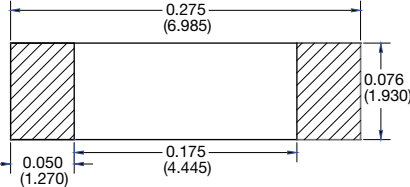

2512 Land Pattern

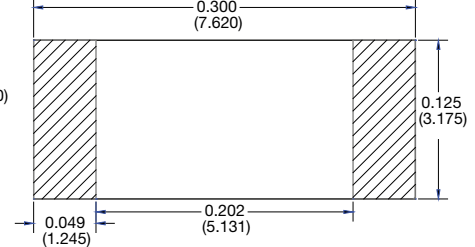



Thin Film Surface Mount Chip Resistors (PHP, PCAN Series)

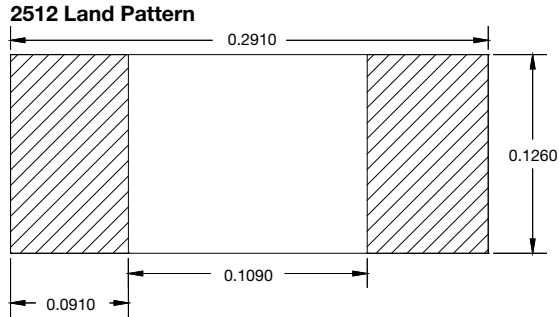
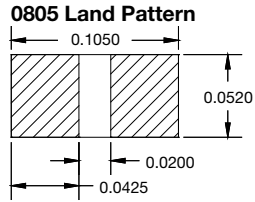
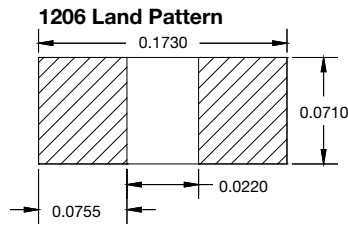
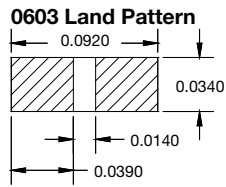

Thin Film Surface Mount Chip Resistors Long Axis Termination (L Series)

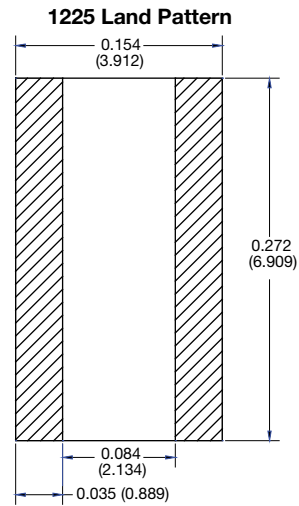
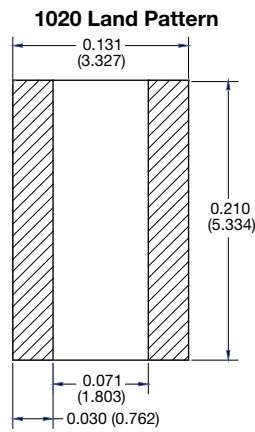
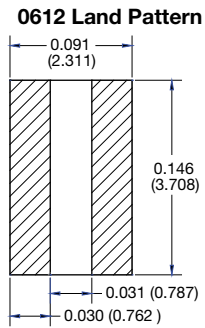
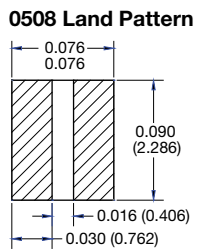



Surface Mount Networks (MPM, MP3, MP4 Series)

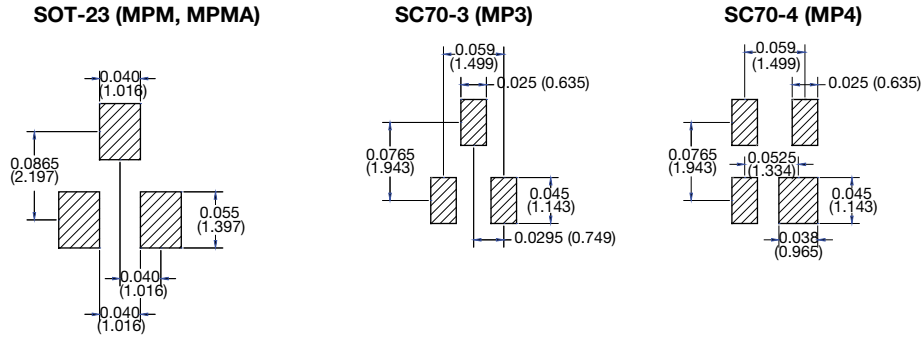

Surface Mount Networks SOIC Narrow Body 150 mils (ORN, CSO, MOMC, HTRN, AORN, MORN Series)

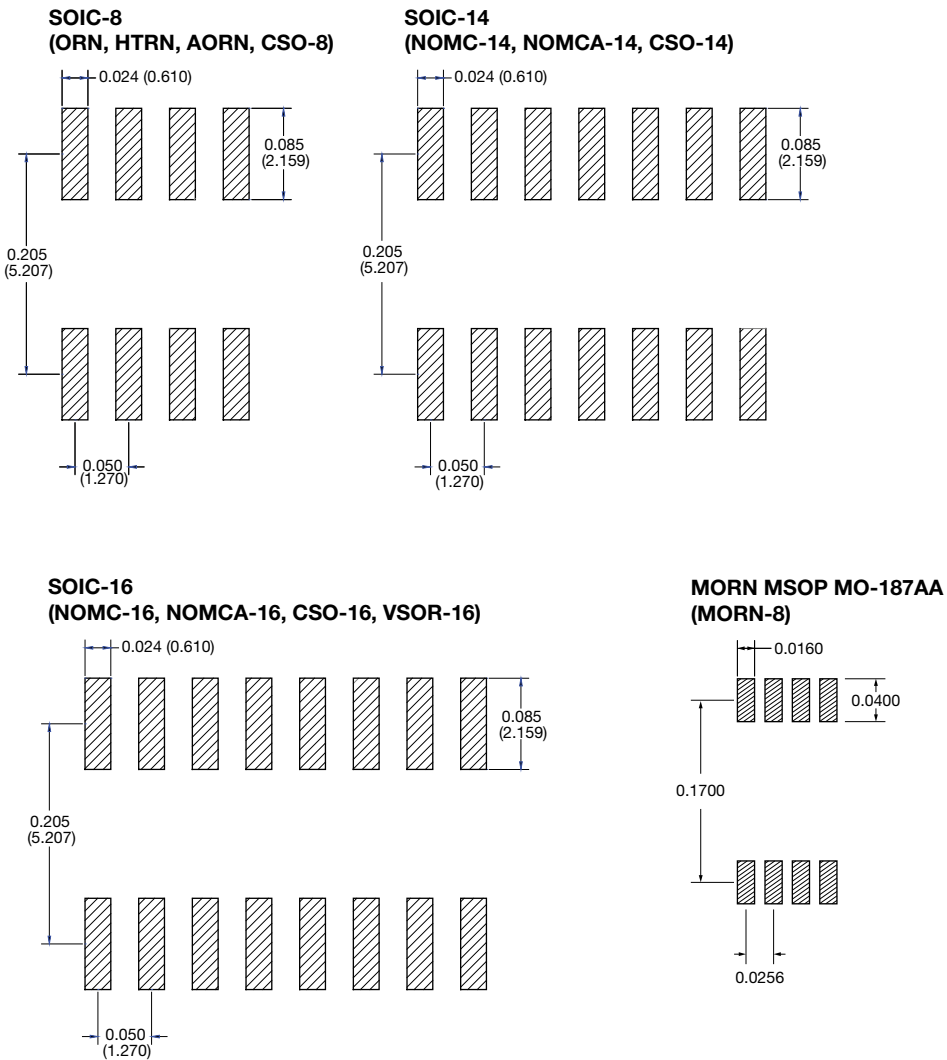



Surface Mount Networks SOIC Medium Body 220 mils (TOMC Series)

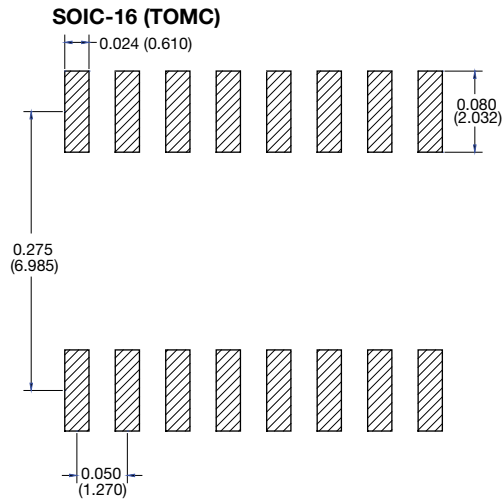

Surface Mount Networks SOIC Wide Body 300 mils (WOMC Series)

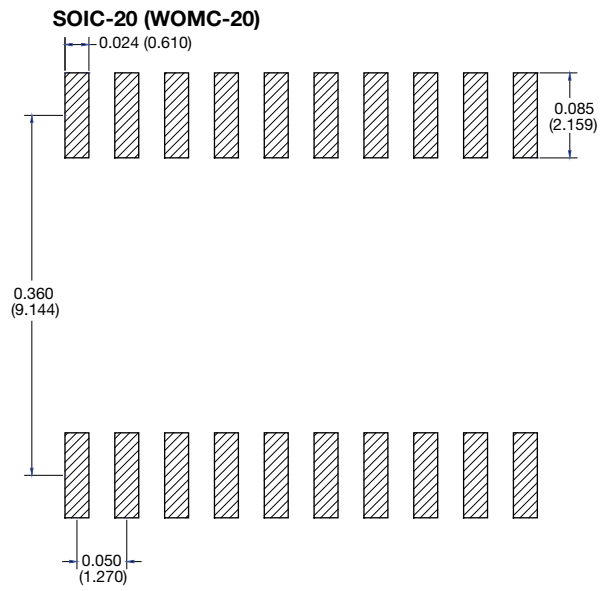
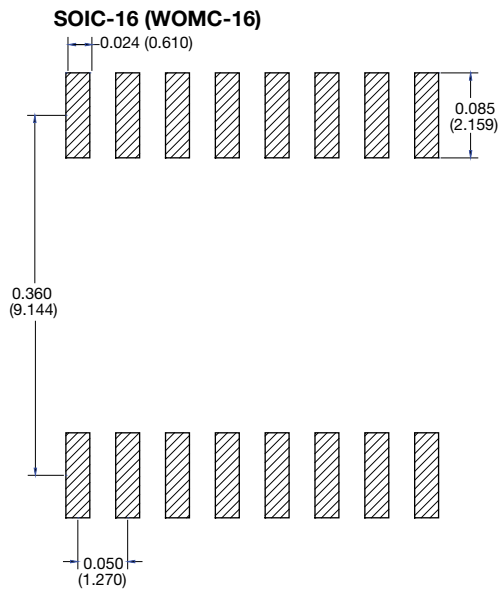



Surface Mount Networks High Density SSOP, TSOP (VSSR, VTSR Series)

SSOP MO-137

OSOP-16, VSSR-16

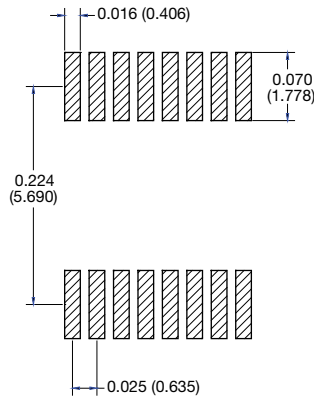

OSOP-20, VSSR-20

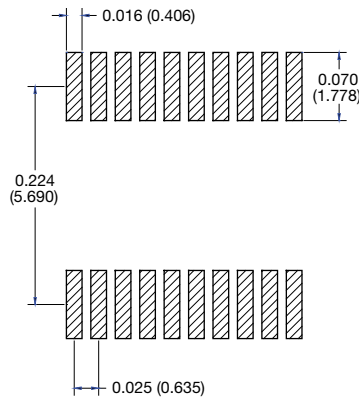

OSOP-24, VSSR-24, HD-CSO-24

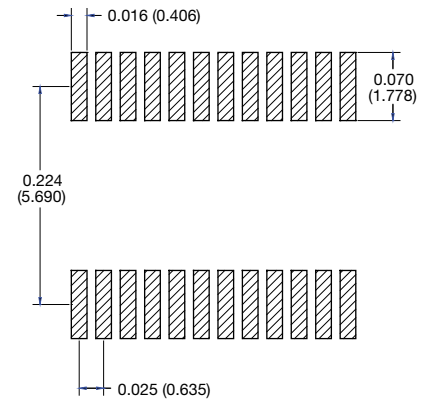

TSSOP MO-153

VTSR-16

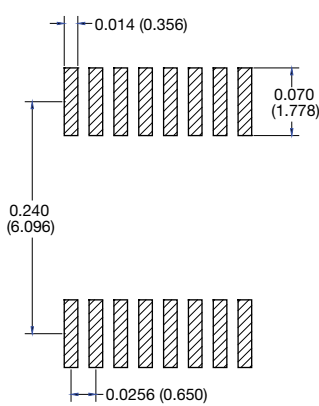

VTSR-20

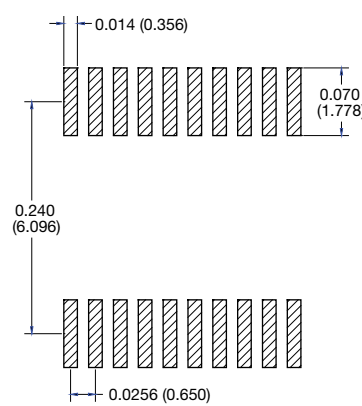

VTSR-24

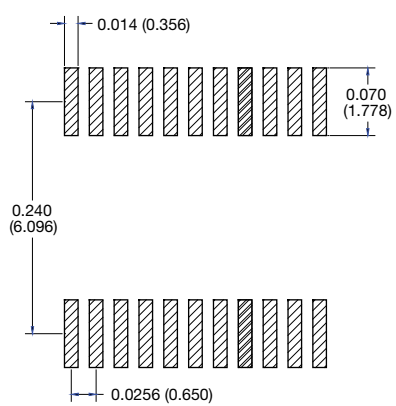

Surface Mount Leadless Networks (LCC Series)

16 Pin LCC

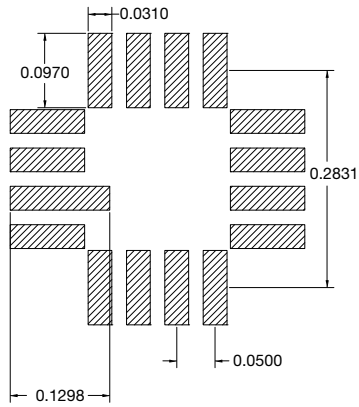

20 Pin LCC

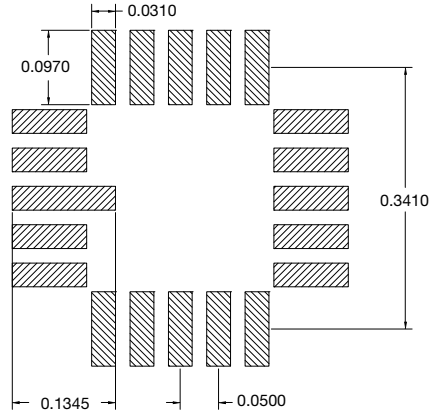

Surface Mount Leadless Networks (MPH Series)

4 Pin LCC

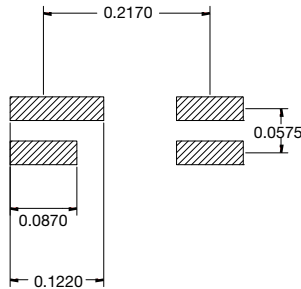

Surface Mount Leadless Packages DUAL/ QUAD Flat No Lead (DFN, QFN Series)

DFN MLP

DFN-8 4 x 5 mm Sq

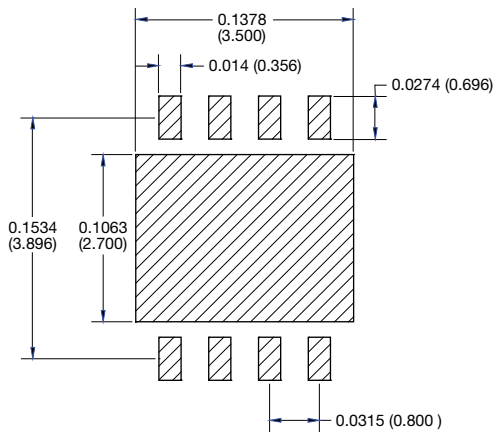

QFN MLP

QFN-20 5 x 5 mm Sq

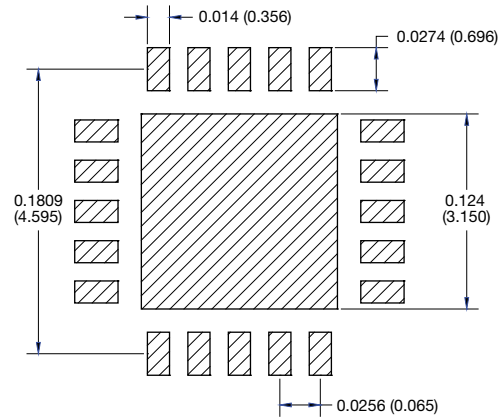

Surface Mount Leadless Resistor Arrays (PR Series)

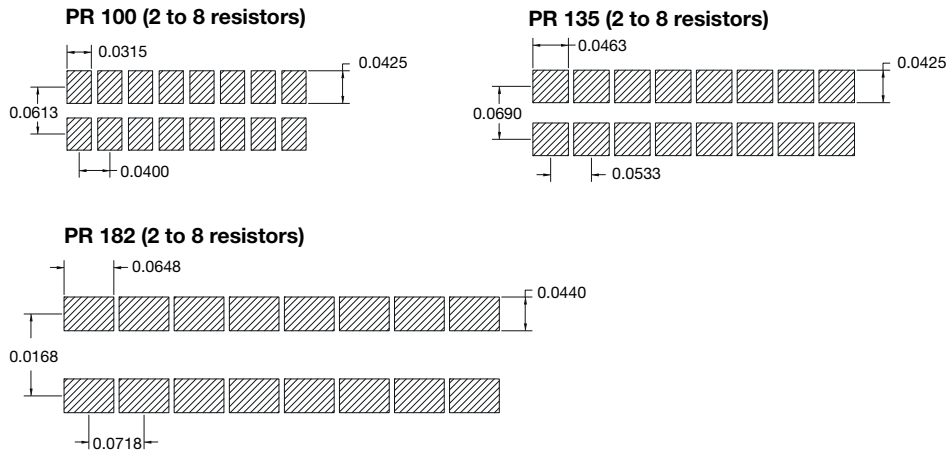

Note

- All dimensions in inches (mm)

Flatpack

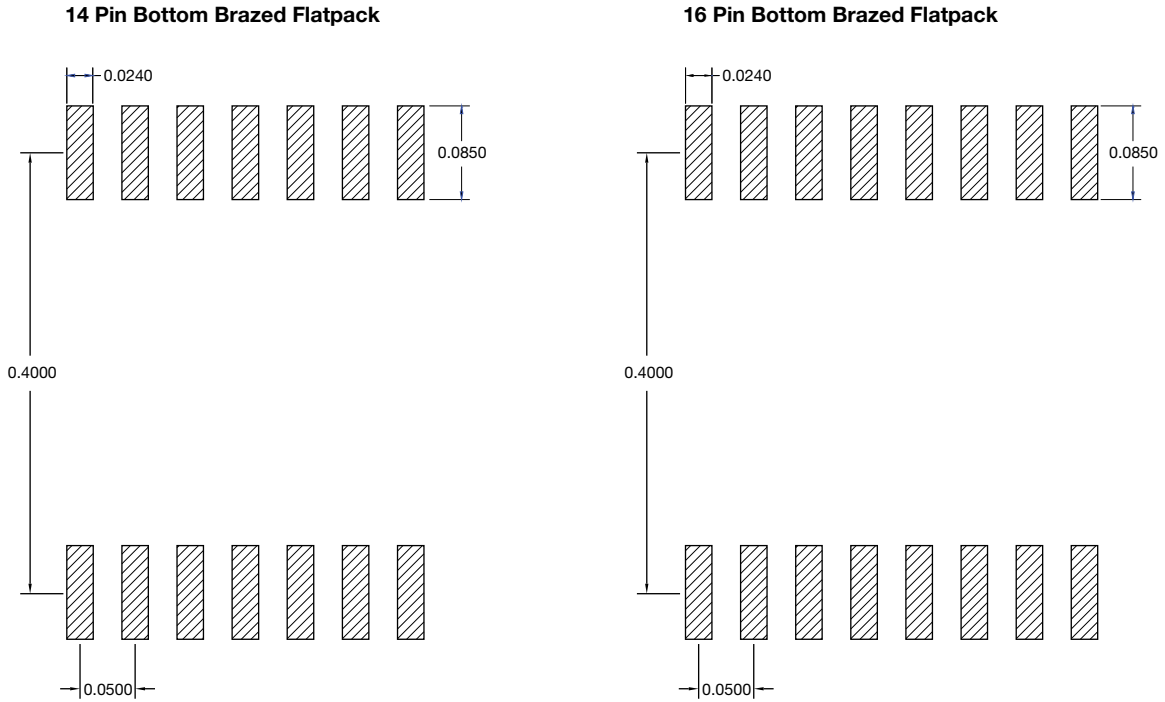



Disclaimer

ALL PRODUCT, PRODUCT SPECIFICATIONS AND DATA ARE SUBJECT TO CHANGE WITHOUT NOTICE TO IMPROVE RELIABILITY, FUNCTION OR DESIGN OR OTHERWISE.

Vishay Intertechnology, Inc., its affiliates, agents, and employees, and all persons acting on its or their behalf (collectively, "Vishay"), disclaim any and all liability for any errors, inaccuracies or incompleteness contained in any datasheet or in any other disclosure relating to any product.

Vishay makes no warranty, representation or guarantee regarding the suitability of the products for any particular purpose or the continuing production of any product. To the maximum extent permitted by applicable law, Vishay disclaims (i) any and all liability arising out of the application or use of any product, (ii) any and all liability, including without limitation special, consequential or incidental damages, and (iii) any and all implied warranties, including warranties of fitness for particular purpose, non-infringement and merchantability.

Statements regarding the suitability of products for certain types of applications are based on Vishay's knowledge of typical requirements that are often placed on Vishay products in generic applications. Such statements are not binding statements about the suitability of products for a particular application. It is the customer's responsibility to validate that a particular product with the properties described in the product specification is suitable for use in a particular application. Parameters provided in datasheets and / or specifications may vary in different applications and performance may vary over time. All operating parameters, including typical parameters, must be validated for each customer application by the customer's technical experts. Product specifications do not expand or otherwise modify Vishay's terms and conditions of purchase, including but not limited to the warranty expressed therein.

Except as expressly indicated in writing, Vishay products are not designed for use in medical, life-saving, or life-sustaining applications or for any other application in which the failure of the Vishay product could result in personal injury or death. Customers using or selling Vishay products not expressly indicated for use in such applications do so at their own risk. Please contact authorized Vishay personnel to obtain written terms and conditions regarding products designed for such applications.

No license, express or implied, by estoppel or otherwise, to any intellectual property rights is granted by this document or by any conduct of Vishay. Product names and markings noted herein may be trademarks of their respective owners.