



Automotive N-Channel 100 V (D-S) 175 °C MOSFET



PRODUCT SUMMARY	
V _{DS} (V)	100
R _{DS(on)} (Ω) at V _{GS} = 10 V	0.0038
I _D (A)	120
Configuration	Single

FEATURES

- TrenchFET® Power MOSFET
- Package with Low Thermal Resistance
- AEC-Q101 Qualified^d
- 100 % R_g and UIS Tested
- Material categorization:
For definitions of compliance please see www.vishay.com/doc?99912

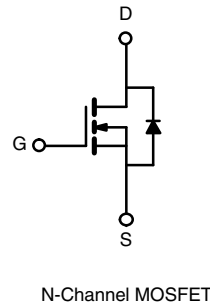
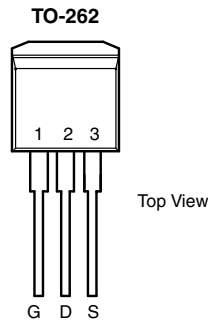

ORDERING INFORMATION	
Package	TO-262
Lead (Pb)-free and Halogen-free	SQV120N10-3m8-GE3

ABSOLUTE MAXIMUM RATINGS (T _C = 25 °C, unless otherwise noted)				
PARAMETER	SYMBOL	LIMIT	UNIT	
Drain-Source Voltage	V _{DS}	100	V	
Gate-Source Voltage	V _{GS}	± 20		
Continuous Drain Current	I _D	T _C = 25 °C ^a	120	
		T _C = 125 °C	102	
Continuous Source Current (Diode Conduction) ^a	I _S	120	A	
Pulsed Drain Current ^b	I _{DM}	480		
Single Pulse Avalanche Current	I _{AS}	73		
Single Pulse Avalanche Energy	E _{AS}	L = 0.1 mH	266	mJ
Maximum Power Dissipation ^b			T _C = 25 °C	
		T _C = 125 °C	83	W
Operating Junction and Storage Temperature Range	T _J , T _{stg}	- 55 to + 175	°C	

THERMAL RESISTANCE RATINGS			
PARAMETER	SYMBOL	LIMIT	UNIT
Junction-to-Ambient	R _{thJA}	40	°C/W
Junction-to-Case (Drain)			

Notes

- Package limited.
- Pulse test; pulse width ≤ 300 μs, duty cycle ≤ 2 %.
- When mounted on 1" square PCB (FR-4 material).
- Parametric verification ongoing.



SPECIFICATIONS (T _C = 25 °C, unless otherwise noted)						
PARAMETER	SYMBOL	TEST CONDITIONS	MIN.	TYP.	MAX.	UNIT
Static						
Drain-Source Breakdown Voltage	V _{DS}	V _{GS} = 0, I _D = 250 μA	100	-	-	V
Gate-Source Threshold Voltage	V _{GS(th)}	V _{DS} = V _{GS} , I _D = 250 μA	2.5	3.0	3.5	
Gate-Source Leakage	I _{GSS}	V _{DS} = 0 V, V _{GS} = ± 20 V	-	-	± 100	nA
Zero Gate Voltage Drain Current	I _{DSS}	V _{GS} = 0 V, V _{DS} = 100 V	-	-	1	μA
		V _{GS} = 0 V, V _{DS} = 100 V, T _J = 125 °C	-	-	50	
		V _{GS} = 0 V, V _{DS} = 100 V, T _J = 175 °C	-	-	500	
On-State Drain Current ^a	I _{D(on)}	V _{GS} = 10 V, V _{DS} ≥ 5 V	120	-	-	A
Drain-Source On-State Resistance ^a	R _{DS(on)}	V _{GS} = 10 V, I _D = 20 A	-	0.0030	0.0038	Ω
		V _{GS} = 10 V, I _D = 20 A, T _J = 125 °C	-	-	0.0064	
		V _{GS} = 10 V, I _D = 20 A, T _J = 175 °C	-	-	0.0080	
Forward Transconductance ^b	g _{fs}	V _{DS} = 15 V, I _D = 20 A	-	82	-	S
Dynamic^b						
Input Capacitance	C _{iss}	V _{GS} = 0 V, V _{DS} = 25 V, f = 1 MHz	-	5780	7230	pF
Output Capacitance	C _{oss}		-	3070	3840	
Reverse Transfer Capacitance	C _{rss}		-	305	385	
Total Gate Charge ^c	Q _g	V _{GS} = 10 V, V _{DS} = 50 V, I _D = 70 A	-	125	190	nC
Gate-Source Charge ^c	Q _{gs}		-	28	-	
Gate-Drain Charge ^c	Q _{gd}		-	46	-	
Gate Resistance	R _g	f = 1 MHz	1.6	3.3	5	Ω
Turn-On Delay Time ^c	t _{d(on)}	V _{DD} = 50 V, R _L = 0.7 Ω I _D ≅ 70 A, V _{GEN} = 10 V, R _g = 1 Ω	-	16	25	ns
Rise Time ^c	t _r		-	110	165	
Turn-Off Delay Time ^c	t _{d(off)}		-	40	60	
Fall Time ^c	t _f		-	12	20	
Source-Drain Diode Ratings and Characteristics^b						
Pulsed Current ^a	I _{SM}		-	-	480	A
Forward Voltage	V _{SD}	I _F = 100 A, V _{GS} = 0	-	0.9	1.5	V

Notes

- a. Pulse test; pulse width ≤ 300 μs, duty cycle ≤ 2 %.
- b. Guaranteed by design, not subject to production testing.
- c. Independent of operating temperature.

Stresses beyond those listed under "Absolute Maximum Ratings" may cause permanent damage to the device. These are stress ratings only, and functional operation of the device at these or any other conditions beyond those indicated in the operational sections of the specifications is not implied. Exposure to absolute maximum rating conditions for extended periods may affect device reliability.



TYPICAL CHARACTERISTICS (T_A = 25 °C, unless otherwise noted)

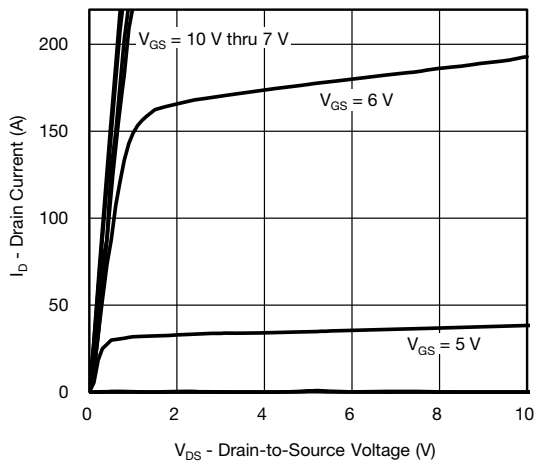

Output Characteristics

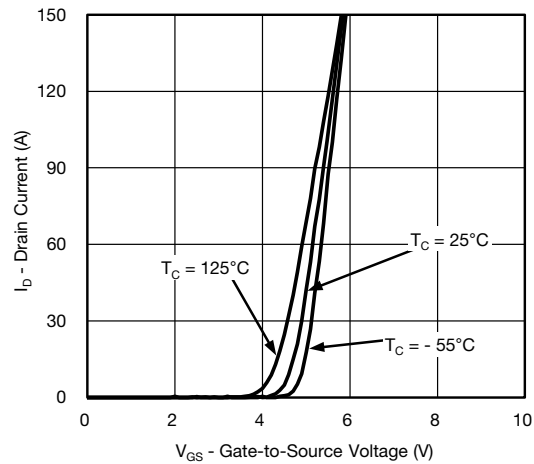

Transfer Characteristics

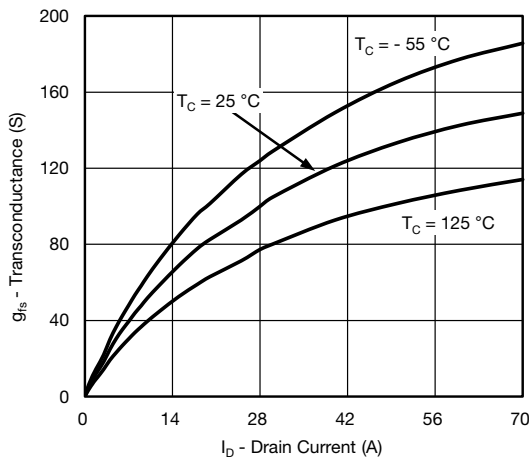

Transconductance

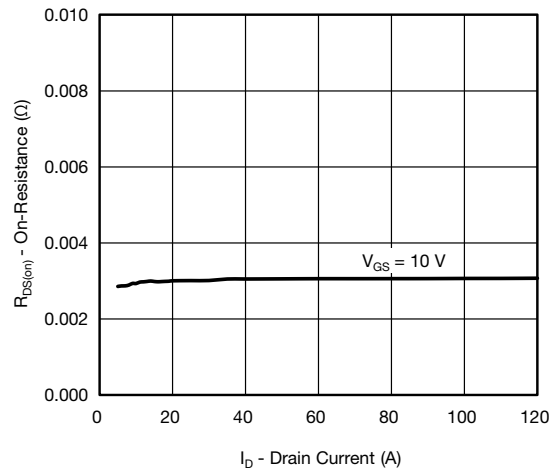

On-Resistance vs. Drain Current

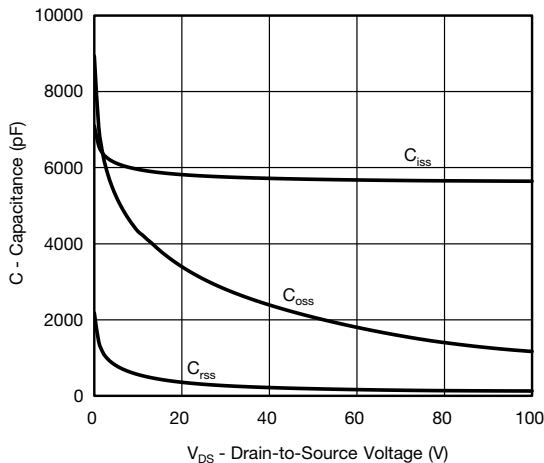

Capacitance

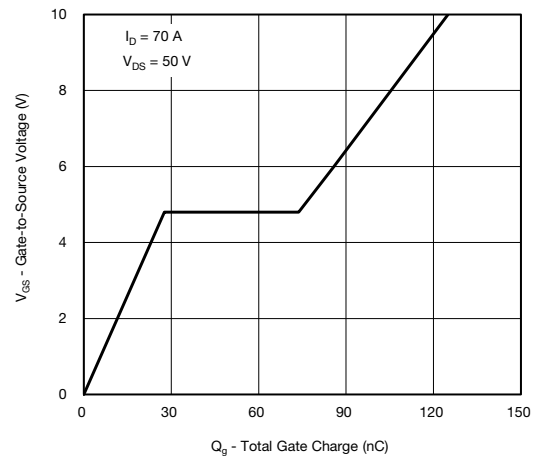

Gate Charge



TYPICAL CHARACTERISTICS ($T_A = 25\text{ }^\circ\text{C}$, unless otherwise noted)

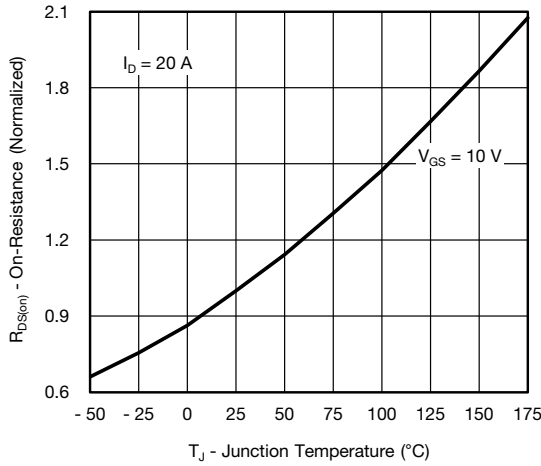

On-Resistance vs. Junction Temperature

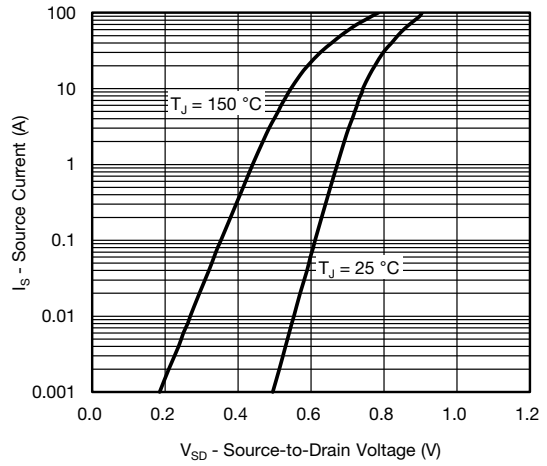

Source Drain Diode Forward Voltage

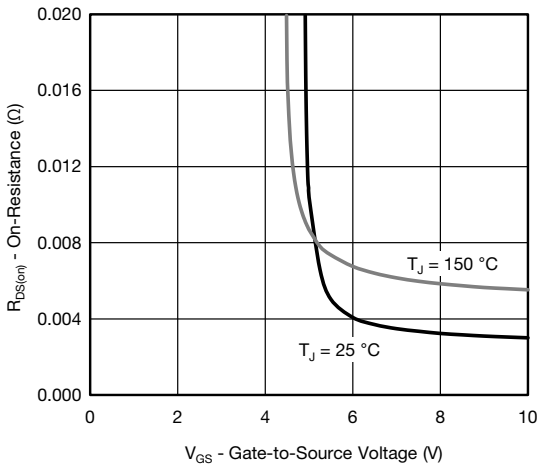

On-Resistance vs. Gate-to-Source Voltage

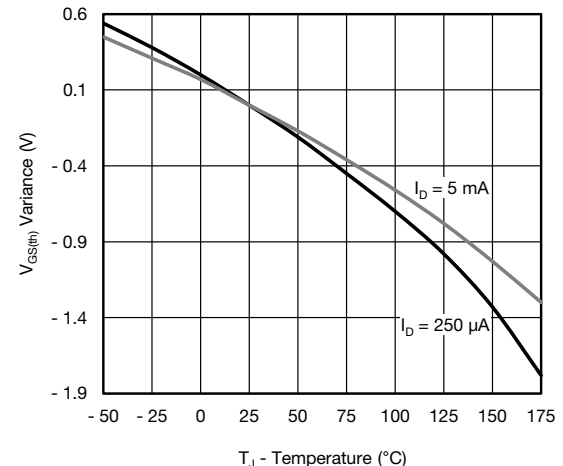

Threshold Voltage

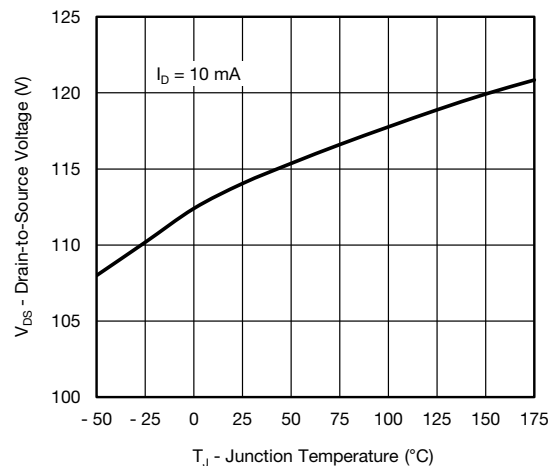

Drain Source Breakdown vs. Junction Temperature



THERMAL RATINGS ($T_A = 25\text{ }^\circ\text{C}$, unless otherwise noted)

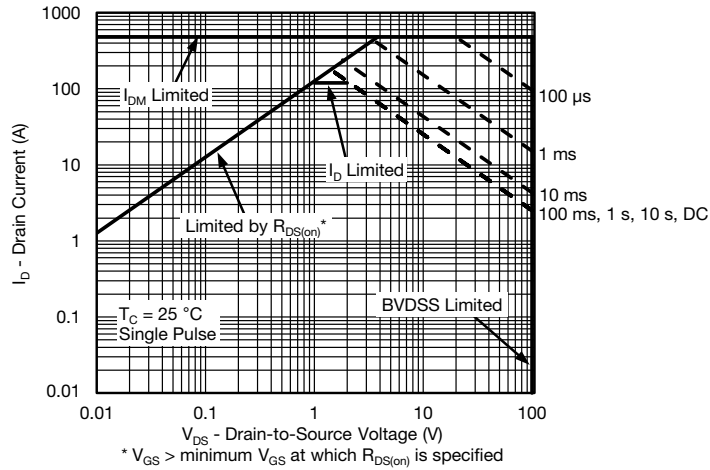

Safe Operating Area

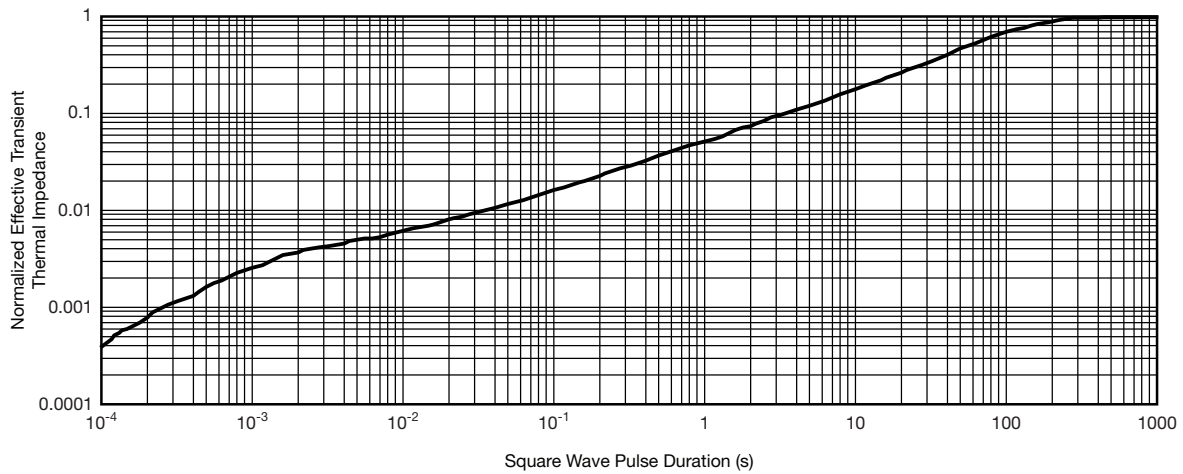

Normalized Thermal Transient Impedance, Junction-to-Ambient



THERMAL RATINGS ($T_A = 25\text{ }^\circ\text{C}$, unless otherwise noted)

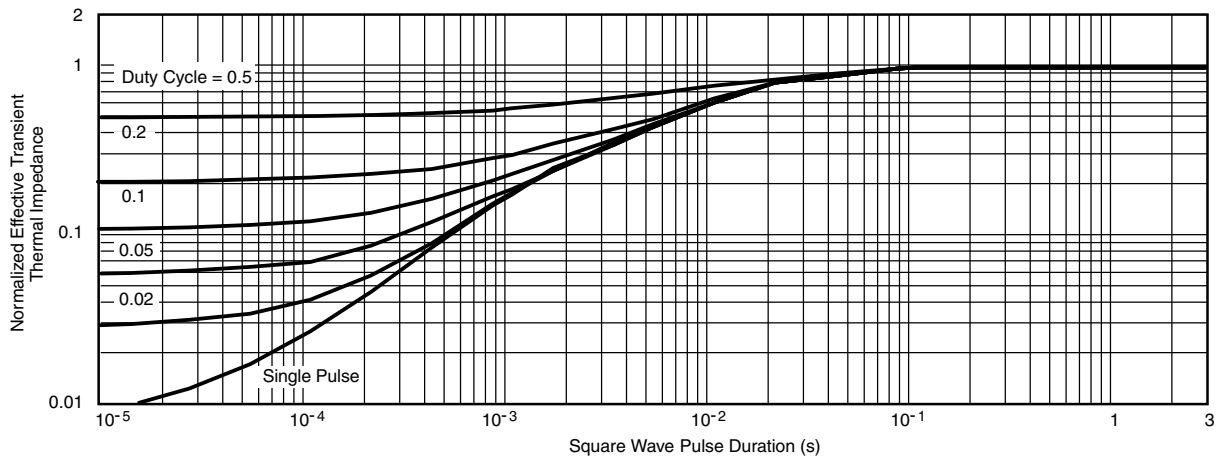

Normalized Thermal Transient Impedance, Junction-to-Case

Note

- The characteristics shown in the two graphs
 - Normalized Transient Thermal Impedance Junction to Ambient (25 °C)
 - Normalized Transient Thermal Impedance Junction to Case (25 °C)
 are given for general guidelines only to enable the user to get a “ball park” indication of part capabilities. The data are extracted from single pulse transient thermal impedance characteristics which are developed from empirical measurements. The latter is valid for the part mounted on printed circuit board - FR4, size 1" x 1" x 0.062", double sided with 2 oz. copper, 100 % on both sides. The part capabilities can widely vary depending on actual application parameters and operating conditions.

Vishay Siliconix maintains worldwide manufacturing capability. Products may be manufactured at one of several qualified locations. Reliability data for Silicon Technology and Package Reliability represent a composite of all qualified locations. For related documents such as package/tape drawings, part marking, and reliability data, see www.vishay.com/ppg?63402.



D²PAK / TO-263 and TO-262

Ordering codes for the SQ rugged series power MOSFETs in the D²PAK / TO-263 and TO-262 packages:

DATASHEET PART NUMBER	OLD ORDERING CODE ^a	NEW ORDERING CODE
SQM100N04-2m7	SQM100N04-2M7-GE3	SQM100N04-2M7_GE3
SQM100N10-10	SQM100N10-10-GE3	SQM100N10-10_GE3
SQM110N05-06L	SQM110N05-06L-GE3	SQM110N05-06L_GE3
SQM110P06-8m9L	SQM110P06-8M9L-GE3	SQM110P06-8M9L_GE3
SQM120N02-1m3L	SQM120N02-1M3L-GE3	SQM120N02-1M3L_GE3
SQM120N03-1m5L	SQM120N03-1M5L-GE3	SQM120N03-1M5L_GE3
SQM120N04-1m7	SQM120N04-1M7-GE3	SQM120N04-1M7_GE3
SQM120N04-1m7L	SQM120N04-1M7L-GE3	SQM120N04-1M7L_GE3
SQM120N04-1m9	SQM120N04-1M9-GE3	SQM120N04-1M9_GE3
SQM120N06-06	SQM120N06-06-GE3	SQM120N06-06_GE3
SQM120N06-3m5L	SQM120N06-3M5L-GE3	SQM120N06-3M5L_GE3
SQM120N10-09	SQM120N10-09-GE3	SQM120N10-09_GE3
SQM120N10-3m8	SQM120N10-3M8-GE3	SQM120N10-3M8_GE3
SQM120P04-04L	SQM120P04-04L-GE3	SQM120P04-04L_GE3
SQM120P06-07L	SQM120P06-07L-GE3	SQM120P06-07L_GE3
SQM200N04-1m1L	SQM200N04-1M1L-GE3	SQM200N04-1M1L_GE3
SQM200N04-1m7L	SQM200N04-1M7L-GE3	SQM200N04-1M7L_GE3
SQM200N04-1m8	SQM200N04-1M8-GE3	SQM200N04-1M8_GE3
SQM25N15-52	SQM25N15-52-GE3	SQM25N15-52_GE3
SQM35N30-97	SQM35N30-97-GE3	SQM35N30-97_GE3
SQM40N10-30	SQM40N10-30-GE3	SQM40N10-30_GE3
SQM40N15-38	SQM40N15-38-GE3	SQM40N15-38_GE3
SQM40P10-40L	SQM40P10-40L-GE3	SQM40P10-40L_GE3
SQM47N10-24L	SQM47N10-24L-GE3	SQM47N10-24L_GE3
SQM50020EL	-	SQM50020EL_GE3
SQM50N04-4m0L	SQM50N04-4M0L-GE3	SQM50N04-4M0L_GE3
SQM50N04-4m1	SQM50N04-4M1-GE3	SQM50N04-4M1_GE3
SQM50P03-07	SQM50P03-07-GE3	SQM50P03-07_GE3
SQM50P04-09L	SQM50P04-09L-GE3	SQM50P04-09L_GE3
SQM50P06-15L	SQM50P06-15L-GE3	SQM50P06-15L_GE3
SQM50P08-25L	SQM50P08-25L-GE3	SQM50P08-25L_GE3
SQM60N06-15	SQM60N06-15-GE3	SQM60N06-15_GE3
SQM60N20-35	SQM60N20-35-GE3	SQM60N20-35_GE3
SQM85N15-19	SQM85N15-19-GE3	SQM85N15-19_GE3
SQV120N10-3m8	SQV120N10-3m8-GE3	SQV120N10-3m8_GE3
SQV120N06-4m7L	-	SQV120N06-4m7L_GE3

Note

a. Old ordering code is obsolete and no longer valid for new orders



TO-262: 3-LEAD

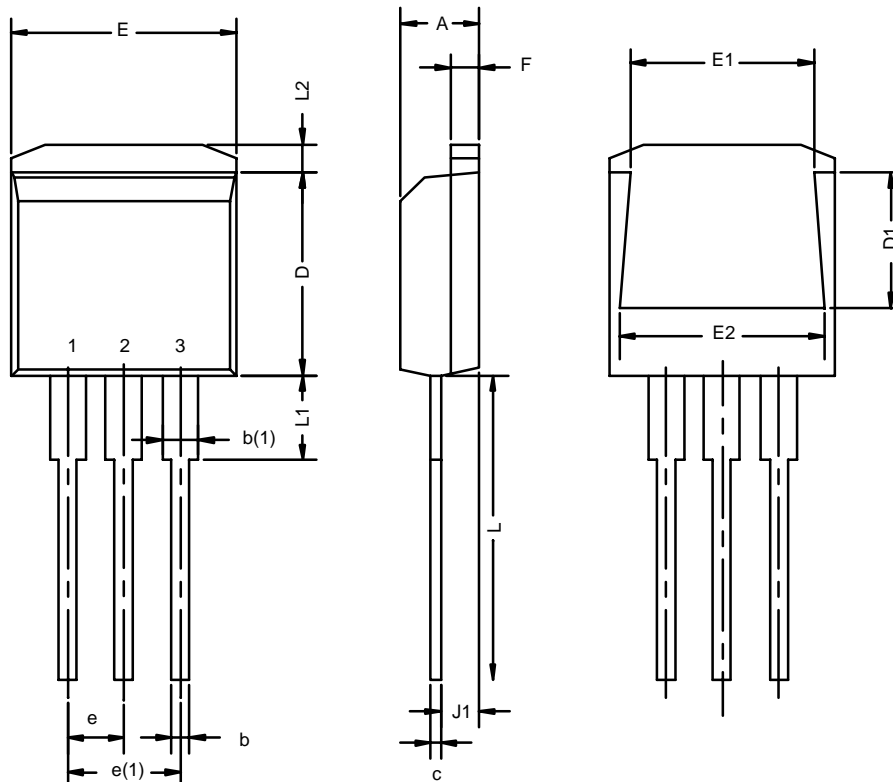

Dim	MILLIMETERS*		INCHES	
	Min	Max	Min	Max
A	4.32	4.70	0.170	0.185
b	0.64	1.00	0.025	0.039
b(1)	1.14	1.40	0.045	0.055
c	0.36	0.50	0.014	0.020
D	8.64	9.65	0.340	0.380
D1	5.59	6.10	0.220	0.240
e	2.41	2.67	0.095	0.105
e(1)	4.95	5.33	0.195	0.210
E	10.03	10.41	0.395	0.410
E1	7.87	8.64	0.310	0.340
E2	9.02	9.53	0.355	0.375
F	1.14	1.40	0.045	0.055
J1	2.41	2.79	0.095	0.110
L	13.08	14.22	0.515	0.560
L1	-	3.81	-	0.150
L2	1.02	1.40	0.040	0.055

ECN: T-02234—Rev. C, 14-Oct-02
DWG: 5855

*Use millimeters as the primary measurement



Disclaimer

ALL PRODUCT, PRODUCT SPECIFICATIONS AND DATA ARE SUBJECT TO CHANGE WITHOUT NOTICE TO IMPROVE RELIABILITY, FUNCTION OR DESIGN OR OTHERWISE.

Vishay Intertechnology, Inc., its affiliates, agents, and employees, and all persons acting on its or their behalf (collectively, "Vishay"), disclaim any and all liability for any errors, inaccuracies or incompleteness contained in any datasheet or in any other disclosure relating to any product.

Vishay makes no warranty, representation or guarantee regarding the suitability of the products for any particular purpose or the continuing production of any product. To the maximum extent permitted by applicable law, Vishay disclaims (i) any and all liability arising out of the application or use of any product, (ii) any and all liability, including without limitation special, consequential or incidental damages, and (iii) any and all implied warranties, including warranties of fitness for particular purpose, non-infringement and merchantability.

Statements regarding the suitability of products for certain types of applications are based on Vishay's knowledge of typical requirements that are often placed on Vishay products in generic applications. Such statements are not binding statements about the suitability of products for a particular application. It is the customer's responsibility to validate that a particular product with the properties described in the product specification is suitable for use in a particular application. Parameters provided in datasheets and/or specifications may vary in different applications and performance may vary over time. All operating parameters, including typical parameters, must be validated for each customer application by the customer's technical experts. Product specifications do not expand or otherwise modify Vishay's terms and conditions of purchase, including but not limited to the warranty expressed therein.

Except as expressly indicated in writing, Vishay products are not designed for use in medical, life-saving, or life-sustaining applications or for any other application in which the failure of the Vishay product could result in personal injury or death. Customers using or selling Vishay products not expressly indicated for use in such applications do so at their own risk. Please contact authorized Vishay personnel to obtain written terms and conditions regarding products designed for such applications.

No license, express or implied, by estoppel or otherwise, to any intellectual property rights is granted by this document or by any conduct of Vishay. Product names and markings noted herein may be trademarks of their respective owners.

Material Category Policy

Vishay Intertechnology, Inc. hereby certifies that all its products that are identified as RoHS-Compliant fulfill the definitions and restrictions defined under Directive 2011/65/EU of The European Parliament and of the Council of June 8, 2011 on the restriction of the use of certain hazardous substances in electrical and electronic equipment (EEE) - recast, unless otherwise specified as non-compliant.

Please note that some Vishay documentation may still make reference to RoHS Directive 2002/95/EC. We confirm that all the products identified as being compliant to Directive 2002/95/EC conform to Directive 2011/65/EU.

Vishay Intertechnology, Inc. hereby certifies that all its products that are identified as Halogen-Free follow Halogen-Free requirements as per JEDEC JS709A standards. Please note that some Vishay documentation may still make reference to the IEC 61249-2-21 definition. We confirm that all the products identified as being compliant to IEC 61249-2-21 conform to JEDEC JS709A standards.