

QBW018A0B Series Power Modules, DC - DC Converters: 36 – 75Vdc Input; 12Vdc Output; 18A Output Current

RoHS Compliant



Applications

- Distributed power architectures
- Intermediate bus voltage applications
- Telecommunications equipment
- Servers and storage applications
- Networking equipment

Options

- Negative Remote On/Off logic
- Active load sharing (Parallel Operation)
- Baseplate option (-H)
- Auto restart after fault shutdown
- Case ground pin

Description

The QBW018A0B series of dc-dc converters are an expansion of a new generation of DC/DC power modules designed to support 12Vdc intermediate bus applications where multiple low voltages are subsequently generated using discrete/modular point of load (POL) converters. The QBW018A0B series provide up to 18A output current in an industry standard quarter brick, which makes it an ideal choice for small space, high current and 12V intermediate bus voltage applications. The converter incorporates synchronous rectification technology and innovative packaging techniques to achieve ultra high efficiency reaching 93% at 12V full load. This leads to lower power dissipation such that for many applications a heat sink is not required.

The QBW018A0B series power modules are isolated dc-dc converters that operate over an input voltage range from 36 to 75 Vdc and provide a single regulated output. The output is fully isolated from the input, allowing versatile polarity configurations and grounding connections. Built-in filtering for both input and output minimizes the need for external filtering.

Features

- Compliant to RoHS EU Directive 2002/95/EC (-Z versions)
- Compliant to ROHS EU Directive 2002/95/EC with lead solder exemption (non-Z versions)
- High power density: 155 W/in³
- High efficiency – 93% at 12V full load
- Improved Thermal Performance: 12A at 70°C at 2m/s (400LFM)
- Delivers up to 18A output current
- Low output ripple and noise
- Industry standard Quarter brick: 57.9 mm x 36.8 mm x 10.6 mm (2.28 in x 1.45 in x 0.42 in)
- Cost efficient open frame design
- Single optimal regulated output
- 2 : 1 input voltage range
- Constant switching frequency
- Positive Remote On/Off logic
- Output over current/voltage protection
- Overtemperature protection
- Wide operating temperature range (-40°C to 85°C)
- ISO* 9001 certified manufacturing facilities
- Meets the voltage isolation requirements for ETSI 300-132-2 and complies with and is licensed for Basic Insulation rating per EN60950-1
- *UL*** 60950-1 Recognised, *CSA*† C22.2 No. 60950-1-03 Certified, and *VDE*‡ 0805 (IEC60950, 3rd Edition) Licensed
- CE mark meets 2006/95/EC directive§

* ISO is a registered trademark of the International Organization of Standards

** *UL* is a registered trademark of Underwriters Laboratories, Inc.

† *CSA* is a registered trademark of Canadian Standards Association.

‡ *VDE* is a trademark of Verband Deutscher Elektrotechniker e.V.

§ This product is intended for integration into end-use equipment. All of the required procedures of end-use equipment should be followed.

Absolute Maximum Ratings

Stresses in excess of the absolute maximum ratings can cause permanent damage to the device. These are absolute stress ratings only, functional operation of the device is not implied at these or any other conditions in excess of those given in the operations sections of the data sheet. Exposure to absolute maximum ratings for extended periods can adversely affect the device reliability.

| Parameter | Device | Symbol | Min | Max | Unit |
|---|--------|-----------|------|------|------|
| Input Voltage* | | | | | |
| Continuous | | V_{IN} | -0.3 | 75 | Vdc |
| Non- operating continuous | | V_{IN} | -0.3 | 80 | Vdc |
| Operating Ambient Temperature (See Thermal Considerations section) | All | T_A | -40 | 85 | °C |
| Storage Temperature | All | T_{stg} | -55 | 125 | °C |
| I/O Isolation Voltage (100% factory Hi-Pot tested) | All | — | — | 1500 | Vdc |

* Input over voltage protection will shutdown the output voltage when the input voltage exceeds threshold level.

Electrical Specifications

Unless otherwise indicated, specifications apply over all operating input voltage, resistive load, and temperature conditions.

| Parameter | Device | Symbol | Min | Typ | Max | Unit |
|--|--------|--------------|-----|-----|-----|------------------|
| Operating Input Voltage | | V_{IN} | 36 | 48 | 75 | Vdc |
| Maximum Input Current ($V_{IN}=0V$ to 75V, $I_O=I_{O,max}$) | | $I_{IN,max}$ | - | - | 7 | Adc |
| Inrush Transient | All | I^2t | - | - | 1 | A ² s |
| Input Reflected Ripple Current, peak-to-peak (5Hz to 20MHz, 12 μ H source impedance; $V_{IN}=48V$, $I_O=I_{O,max}$; see Figure 9) | All | | - | 24 | - | mAp-p |
| Input Ripple Rejection (120Hz) | All | | - | -50 | - | dB |

CAUTION: This power module is not internally fused. An input line fuse must always be used.

This power module can be used in a wide variety of applications, ranging from simple standalone operation to being part of a complex power architecture. To preserve maximum flexibility, internal fusing is not included, however, to achieve maximum safety and system protection, always use an input line fuse. The safety agencies require a fast-acting fuse with a maximum rating of 15 A (see Safety Considerations section). Based on the information provided in this data sheet on inrush energy and maximum dc input current, the same type of fuse with a lower rating can be used. Refer to the fuse manufacturer's data sheet for further information.

Electrical Specifications (continued)

| Parameter | Device | Symbol | Min | Typ | Max | Unit |
|--|-------------------|--|----------------------|--------------------------|----------------------|--|
| Output Voltage Set-point ($V_{IN}=V_{IN, min}$, $I_O=I_{O, max}$, $T_A=25^\circ\text{C}$) | All | $V_{O, set}$ | | 12 | | V _{dc} |
| Output Voltage (Over all operating input voltage, resistive load, and temperature conditions until end of life) | All | V_O | 11.4 | — | 12.6 | V _{dc} |
| Output Regulation Line ($V_{IN}=V_{IN, min}$ to $V_{IN, max}$) Load ($I_O=I_{O, min}$ to $I_{O, max}$) Temperature ($T_{ref}=T_{A, min}$ to $T_{A, max}$) | All All All | | — — — | 0.2 3 150 | | % $V_{O, set}$ % $V_{O, set}$ mV |
| Output Ripple and Noise on nominal output ($V_{IN}=V_{IN, nom}$ and $I_O=I_{O, min}$ to $I_{O, max}$) RMS (5Hz to 20MHz bandwidth) Peak-to-Peak (5Hz to 20MHz bandwidth) | All All | | — — | 25 70 | — — | mV _{rms} mV _{pk-pk} |
| External Capacitance | All | $C_{O, max}$ | — | — | 3,000 | μF |
| Output Current | All | I_O | 0 | | 18 | Adc |
| Output Current Limit Inception | All | $I_{O, lim}$ | — | 20 | — | Adc |
| Efficiency $V_{IN}=V_{IN, nom}$, $T_A=25^\circ\text{C}$ $I_O=I_{O, max}$, $V_O=V_{O, set}$ | All | η | — | 93 | — | % |
| Switching Frequency | All | f_{sw} | — | 300 | — | kHz |
| Dynamic Load Response ($\Delta I_O/\Delta t=1\text{A}/10\mu\text{s}$; $V_{in}=V_{in, nom}$; $T_A=25^\circ\text{C}$; Tested with a 10 μF aluminum and a 1.0 μF tantalum capacitor across the load.) Load Change from $I_O=50\%$ to 75% of $I_{O, max}$: Peak Deviation Settling Time ($V_O<10\%$ peak deviation) Load Change from $I_O=75\%$ to 50% of $I_{O, max}$: Peak Deviation Settling Time ($V_O<10\%$ peak deviation) | 12V | V_{pk} t_s V_{pk} t_s | — — — — | 4 300 4 300 | — — — — | % $V_{O, set}$ μs % $V_{O, set}$ μs |

Isolation Specifications

| Parameter | Device | Symbol | Min | Typ | Max | Unit |
|-----------------------|--------|-----------|-----|------|-----|------|
| Isolation Capacitance | | C_{iso} | — | 2000 | — | pF |
| Isolation Resistance | | R_{iso} | 10 | — | — | MΩ |

General Specifications

| Parameter | Min | Typ | Max | Unit |
|---|-----|-----------|-----|---------|
| Calculated MTBF ($I_o=80\%$ of $I_{o,max}$, $T_A=25^\circ\text{C}$, airflow=1m/s(200LFM)) | | 3088170 | | Hours |
| Weight | — | 44 (1.55) | — | g (oz.) |

Feature Specifications

Unless otherwise indicated, specifications apply over all operating input voltage, resistive load, and temperature conditions. See Feature Descriptions for additional information.

| Parameter | Device | Symbol | Min | Typ | Max | Unit |
|---|--------|----------------------------------|-----|-----|------|------------|
| <p>Remote On/Off Signal Interface ($V_{IN} = V_{IN, min}$ to $V_{IN, max}$, Signal referenced to V_{IN}-terminal) Negative Logic: Device code suffix "1" Logic Low = module On, Logic High = module Off Positive Logic: No device code suffix required Logic Low = module Off, Logic High = module On On/Off Thresholds:</p> | | | | | | |
| Remote On/Off Current – Logic Low | All | $I_{on/off}$ | 5 | 10 | 15 | μA |
| Logic Low Voltage | All | $V_{on/off}$ | 0.0 | — | 0.8 | V |
| Logic High Voltage – (Typ = Open Collector) | All | $V_{on/off}$ | 2.0 | — | 5.0 | V |
| Logic High maximum allowable leakage current ($V_{on/off} = 2.0V$) | All | $I_{on/off}$ | — | — | 6.0 | μA |
| Maximum voltage allowed on On/Off pin | All | $V_{on/off}$ | — | — | 14.0 | V |
| <p>Turn-On Delay and Rise Times ($I_O = I_{O, max}$, $V_{IN} = V_{IN, nom}$, $T_A = 25^\circ C$,)</p> | | | | | | |
| T_{delay} = Time until $V_O = 10\%$ of $V_{O, set}$ from either application of V_{in} with Remote On/Off set to On or operation of Remote On/Off from Off to On with V_{in} already applied for at least one second. | All | $T_{delay \text{ with } V_{in}}$ | | 16 | | msec |
| | All | $T_{delay \text{ with On/Off}}$ | | 1 | | msec |
| Output Voltage Rise time (time for V_O to rise from 10% of $V_{O, set}$ to 90% of $V_{O, set}$) | All | T_{rise} | — | 1 | | msec |
| Turn-On Output Voltage Overshoot (above $V_{O, set}$) | All | | | 200 | | mV |
| Output Overvoltage Protection (Clamp) | All | | 13 | — | 15 | V |
| Overtemperature Protection (See Thermal Consideration section) | All | T_{ref} | — | 125 | — | $^\circ C$ |
| Input Undervoltage Lockout | | | | | | |
| Turn-on Threshold | All | | — | 35 | 36 | V |
| Turn-off Threshold | All | | 32 | 34 | — | V |

Characteristic Curves

The following figures provide typical characteristics for the QBW018A0B (12V, 18A) at 25°C. The figures are identical for either positive or negative Remote On/Off logic.

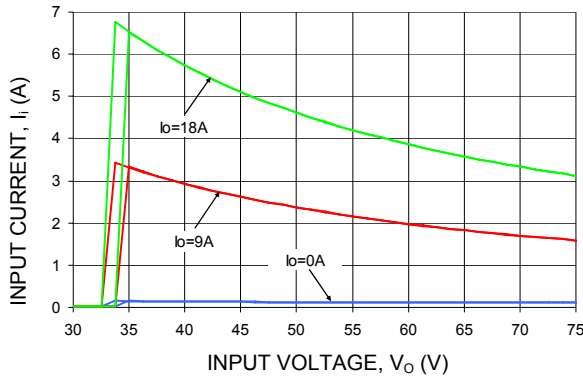

Figure 1. Typical Input Characteristic at Room Temperature

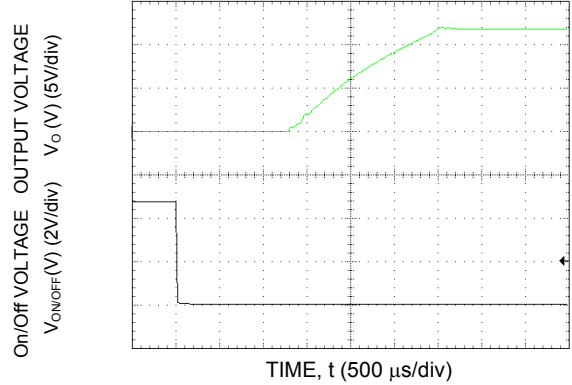

Figure 4. Typical Start-Up Using Remote On/Off, negative logic version shown.

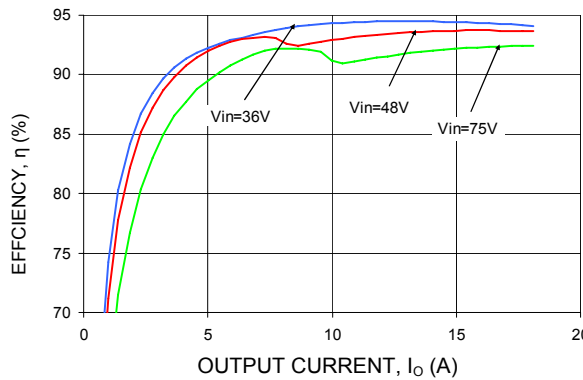

Figure 2. Typical Converter Efficiency Vs. Output current at Room Temperature

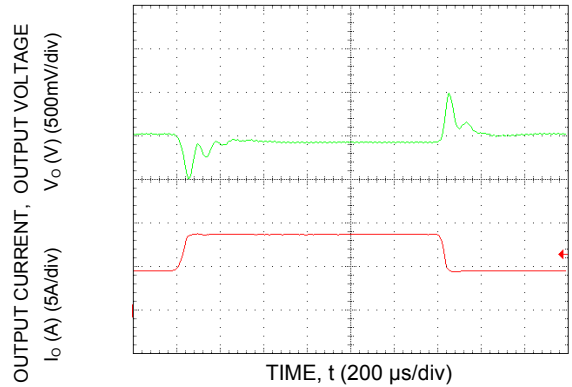

Figure 5. Typical Transient Response to Step change in Load from 25% to 50% to 25% of Full Load at Room Temperature and 48 Vdc Input.

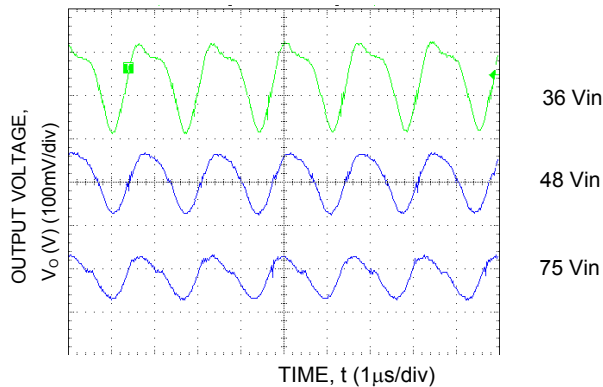

Figure 3. Typical Output Ripple and Noise at Room Temperature and $I_o = I_{o,max}$

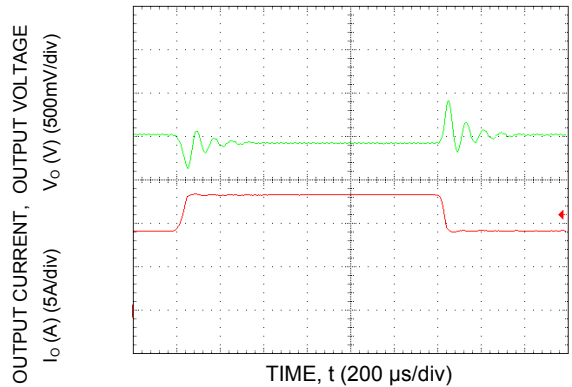

Figure 6. Typical Transient Response to Step Change in Load from 50% to 75% to 50% of Full Load at Room Temperature and 48 Vdc Input

Characteristic Curves (continued)

The following figures provide typical characteristics for the QBW018A0B (12V, 18A) at 25°C. The figures are identical for either positive or negative Remote On/Off logic.

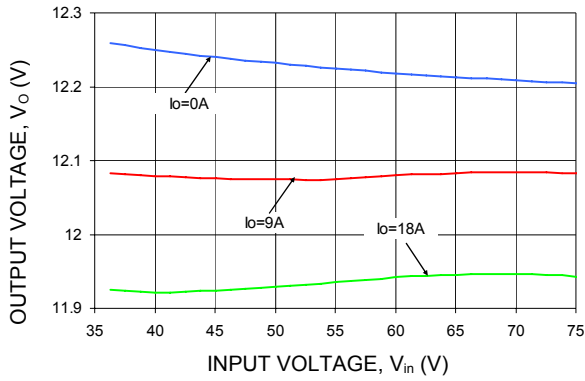

Figure 7. Typical Output voltage regulation vs. Input voltage at Room Temperature

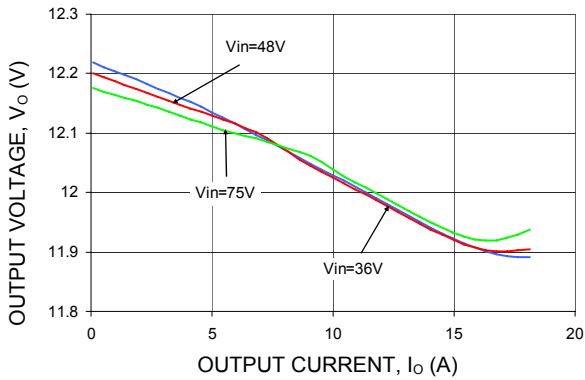
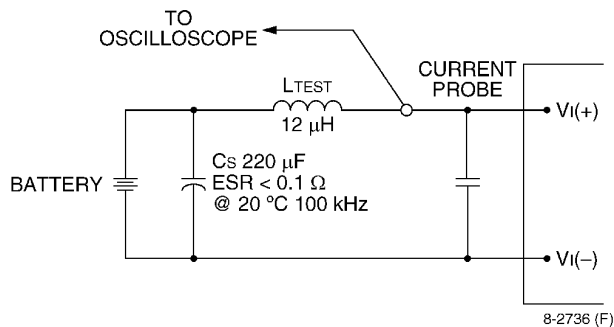

Figure 8. Typical Output voltage regulation Vs. Output current at Room Temperature

Test Configurations



Note: Measure input reflected-ripple current with a simulated source inductance (LTEST) of 12 µH. Capacitor CS offsets possible battery impedance. Measure current as shown above.

Figure 9. Input Reflected Ripple Current Test Setup.

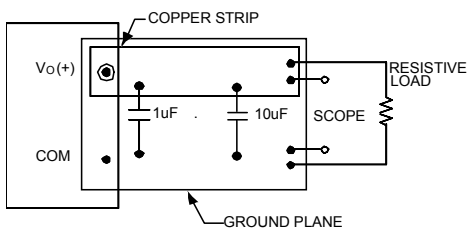

NOTE: All voltage measurements to be taken at the module terminals, as shown above. If sockets are used then Kelvin connections are required at the module terminals to avoid measurement errors due to socket contact resistance.

Figure 10. Output Ripple and Noise Test Setup.

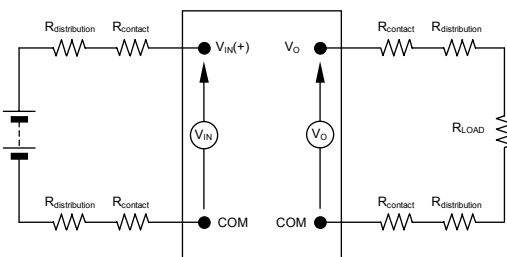

NOTE: All voltage measurements to be taken at the module terminals, as shown above. If sockets are used then Kelvin connections are required at the module terminals to avoid measurement errors due to socket contact resistance.

Figure 11. Output Voltage and Efficiency Test Setup.

$$\text{Efficiency } \eta = \frac{V_o \cdot I_o}{V_{IN} \cdot I_{IN}} \times 100 \%$$

Design Considerations

Input Filtering

The power module should be connected to a low ac-impedance source. A highly inductive source impedance can affect the stability of the power module. For the test configuration in Figure 9, a 100µF electrolytic capacitor (ESR<0.7Ω at 100kHz), mounted close to the power module helps ensure the stability of the unit. Consult the factory for further application guidelines.

Safety Considerations

For safety-agency approval of the system in which the power module is used, the power module must be installed in compliance with the spacing and separation requirements of the end-use safety agency standard, i.e., UL 1950, CSA C22.2 No. 60950-00, and VDE 0805:2001-12 (IEC60950 3rd Ed).

If the input source is non-SELV (ELV or a hazardous voltage greater than 60 Vdc and less than or equal to 75Vdc), for the module's output to be considered as meeting the requirements for safety extra-low voltage (SELV), all of the following must be true:

- The input source is to be provided with reinforced insulation from any other hazardous voltages, including the ac mains.
- One VIN pin and one VOUT pin are to be grounded, or both the input and output pins are to be kept floating.
- The input pins of the module are not operator accessible.
- Another SELV reliability test is conducted on the whole system (combination of supply source and subject module), as required by the safety agencies, to verify that under a single fault, hazardous voltages do not appear at the module's output.

Note: Do not ground either of the input pins of the module without grounding one of the output pins. This may allow a non-SELV voltage to appear between the output pins and ground.

The power module has extra-low voltage (ELV) outputs when all inputs are ELV. The input to these units is to be provided with a maximum 15 A fast-acting (or time-delay) fuse in the unearthed lead.

Feature Description

Remote On/Off

Two remote on/off options are available. Positive logic remote on/off turns the module on during a logic-high voltage on the ON/OFF pin, and off during a logic low. Negative logic remote on/off turns the module off during a logic high and on during a logic low. Negative logic, device code suffix "1," is the factory-preferred configuration. The on/off circuit is powered from an internal bias supply. To turn the power module on and off, the user must supply a switch to control the voltage between the on/off terminal and the V_i (-) terminal ($V_{on/off}$). The switch can be an open collector or equivalent (see Figure 12). A logic low is $V_{on/off} = 0.0V$ to $0.8V$. The typical $I_{on/off}$ during a logic low is $10 \mu A$. The switch should maintain a logic-low voltage while sinking $10\mu A$. During a logic high, the maximum $V_{on/off}$ generated by the power module is $5.0V$. The maximum allowable leakage current of the switch at $V_{on/off} = 2.0V$ is $6.0\mu A$. If using an external voltage source, the maximum voltage $V_{on/off}$ on the pin is $14.0V$ with respect to the V_i (-) terminal. If not using the remote on/off feature, perform one of the following to turn the unit on:
For negative logic, short ON/OFF pin to V_i (-).
For positive logic: leave ON/OFF pin open.

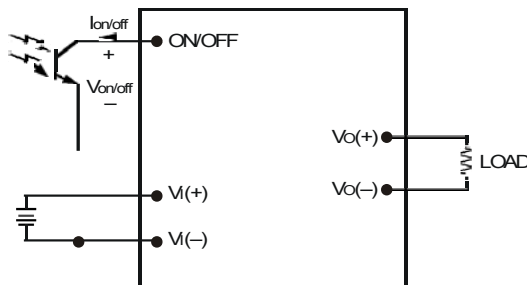

Figure 12. Remote On/Off Implementation

Overcurrent Protection

To provide protection in a fault output overload condition, the module is equipped with internal current-limiting circuitry and can endure current limiting for a few milli-seconds. If the overcurrent condition persists beyond a few milliseconds, the module will shut down and remain latched off. The overcurrent latch is reset by either cycling the input power or by toggling the on/off pin for one second. If the output overload condition still exists when the module restarts, it will shut down again. This operation will continue indefinitely until the overcurrent condition is corrected.

An auto-restart option is also available. An auto-restart feature continually attempts to restore the operation until fault condition is cleared.

Input Undervoltage Lockout

At input voltages above or below the input under/over voltage lockout limits, module operation is disabled. The module will begin to operate when the input voltage level changes to within the under and overvoltage lockout limits.

Overtemperature Protection

These modules feature an overtemperature protection circuit to safeguard against thermal damage. The circuit shuts down and latches off the module when the maximum device reference temperature is exceeded. The module can be restarted by cycling the dc input power for at least one second or by toggling the remote on/off signal for at least one second.

Output Overvoltage Clamp

The output overvoltage clamp consists of a control circuit, independent of the primary regulation loop, that monitors the voltage on the output terminals and clamps the voltage when it exceeds the overvoltage set point. The control loop of the clamp has a higher voltage set point than the primary loop. This provides a redundant voltage control that reduces the risk of output overvoltage.

Feature Description (continued)

Forced Load Sharing (Parallel Operation with – P option)

For additional power requirements, the power module can be configured for parallel operation with active load current sharing. Good layout techniques should be observed for noise immunity when using multiple modules in parallel. To implement active load sharing, the following recommendations must be followed:

- The parallel pins of all units in parallel must be connected together. The path of these connections should be as direct as possible, but should not pass beneath the perimeter of the module body, except immediately adjacent to the parallel pin location.
- Parallel modules must use the same 48V source. The $V_{IN}(-)$ input pin is the return path for the active current share signal of the parallel pin. Separate 48V sources will prevent the active current share return signal from being connected to other modules.
- The $V_{IN}(-)$ input connection should never be disconnected from any of the parallel modules, while another of the parallel modules is operating, unless the $V_{IN}(+)$ pin, or the parallel pin is also disconnected. The $V_{IN}(-)$ input provides the internal logic ground and for the module's primary circuits, including the active current share circuit; and there are sneak paths through the module's internal control ICs, when the $V_{IN}(-)$ pin is disconnected (allowing the internal logic circuit to float), while the parallel pin and $V_{IN}(+)$ pin are connected to other operating modules. These sneak paths do not cause permanent damage, but do create false conditions that can affect the module's internal logic configuration.
- The on/off pins of all modules should also be tied together to the same external control circuitry, so that the modules are turned on and off at the same time, unless all parallel modules' on/off pins are tied to the input pins for automatic start upon application of input voltage.
- When modules in parallel applications contain the auto-restart (4) option, it is required that the total maximum load current value be less than 90% of [n-1] times the individual module output current rating, where n is the number of modules in parallel. For example, if the application is using three modules rated at 18A, then the maximum total load shall be less than $0.9 \times (3-1) \times 18A = 0.9 \times 2 \times 18A = 32.4A$. This insures that a single module can shutdown without causing the total load to exceed the capability of the remaining operating module(s). The shutdown module can

then automatically restart, and assume its share of the total load.

- In all parallel applications (including applications meeting the [n-1] sizing criteria discussed earlier), if it is expected that a protective shutdown event could cause more than one parallel module to shutdown (for example, over temperature due to a common fan failure, or gross over current affecting two or more modules simultaneously), then the use of the auto-restart (4) option is not recommended. The auto-restart interval of these modules is not synchronized to other modules, nor is it precise. There will not be a successful restart following multiple module shutdowns, because the individual module's restart timings will be different. There will not be sufficient module capacity to prevent the first module which restarts from experiencing an over current, and then again shutting down before the slowest module has restarted. Meanwhile, the slowest module will then restart, and then shutdown during the interval the fastest module is waiting for its next restart. And so on and so on. In these cases, only latching shutdown modules should be used; and either toggling the V_{in} source or the on/off pin to simultaneously restart the modules, following a shutdown, is advised.

When not using the parallel feature, leave the share pin open.

Thermal Considerations

The power modules operate in a variety of thermal environments and sufficient cooling should be provided to help ensure reliable operation.

Thermal considerations include ambient temperature, airflow, module power dissipation, and the need for increased reliability. A reduction in the operating temperature of the module will result in an increase in reliability. The thermal data presented here is based on physical measurements taken in a wind tunnel.

Heat-dissipating components are mounted on the top side of the module. Heat is removed by conduction, convection and radiation to the surrounding environment. Proper cooling can be verified by measuring the thermal reference temperature (T_H). Peak temperature (T_H) occurs at the position indicated in Figure 13. For reliable operation this temperature should not exceed the listed temperature threshold.

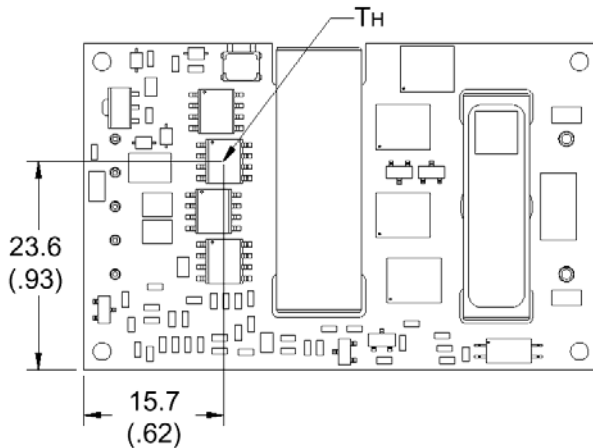

Figure 31. T_{ref} Temperature measurement location.

The output power of the module should not exceed the rated power for the module as listed in the Ordering Information table.

Although the maximum T_H temperature of the power modules is 110 °C - 115 °C, you can limit this temperature to a lower value for extremely high reliability.

Heat Transfer via Convection

Increased airflow over the module enhances the heat transfer via convection. The thermal derating figures (14-17) show the maximum output current that can be delivered by each module in the respective orientation without exceeding the maximum T_H temperature versus local ambient temperature (T_A) for air flows of 1 m/s (200 ft./min) and 2m/s (400 ft./min).

Note that the natural convection condition was measured at 0.05 m/s to 0.1 m/s (10ft./min. to 20 ft./min.); however, systems in which these power modules may be used typically generate natural convection airflow rates of 0.3 m/s (60 ft./min.) due to other heat dissipating components in the system. The use of Figures 14 - 15 are shown in the following example:

Example

What is the minimum airflow necessary for a QBW018A0B operating at $V_I = 48$ V, an output current of 12A, and a maximum ambient temperature of 70 °C in transverse orientation.

Solution:

Given: $V_I = 48$ V, $I_o = 12$ A, $T_A = 70$ °C

Determine required airflow (V) (Use Figure 14):

$V = T1$ m/sec. (200 ft./min.) or greater.

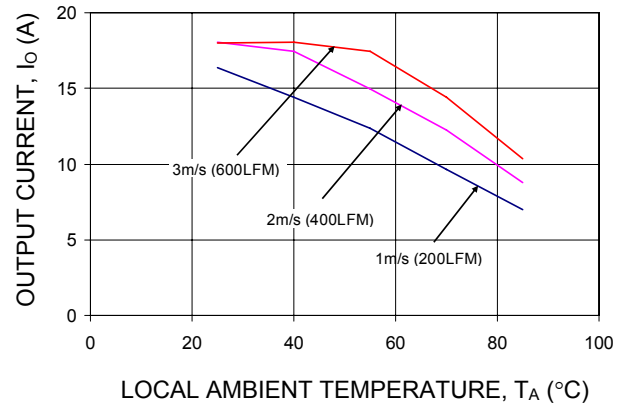

Figure 14. Output Current Derating for the QBW018A0B in the Transverse Orientation with no baseplate; Airflow Direction from Vin(+) to Vin(-); $V_{in} = 48$ V

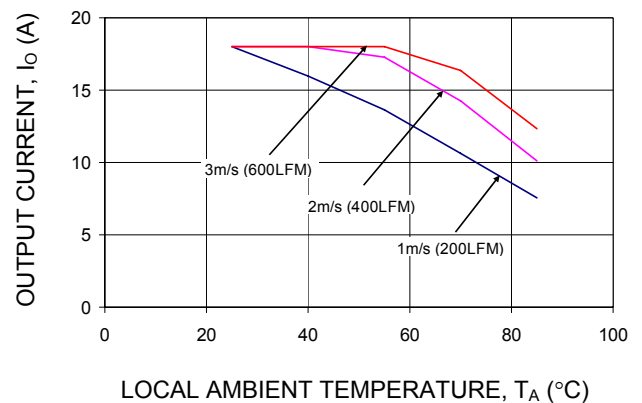

Figure 15. Output Current Derating for the QBW018A0B ($V_o = 12$ V) in the Transverse Orientation with baseplate; Airflow Direction from Vin(+) to Vin(-); $V_{in} = 48$ V

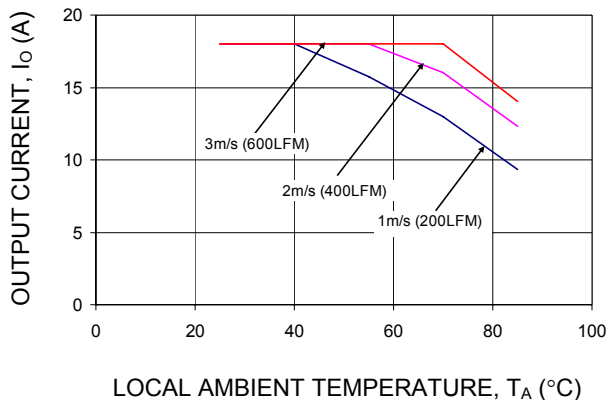

Figure 16. Output Current Derating for the QBW018A0B ($V_o = 12V$) in the Transverse Orientation with baseplate and 0.25-inch high heatsink; Airflow Direction from $V_{in}(-)$ to $V_{out}(-)$; $V_{in} = 48V$

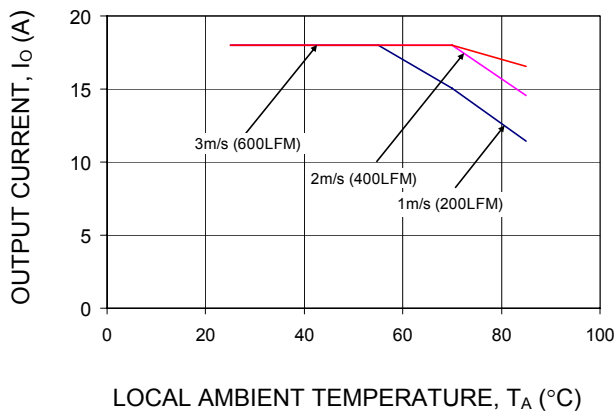

Figure 17. Output Current Derating for the QBW018A0B ($V_o = 12V$) in the Transverse Orientation with baseplate and 0.5-inch high heatsink; Airflow Direction from $V_{in}(-)$ to $V_{out}(-)$; $V_{in} = 48V$

Post solder Cleaning and Drying Considerations

Post solder cleaning is usually the final circuit-board assembly process prior to electrical board testing. The result of inadequate cleaning and drying can affect both the reliability of a power module and the testability of the finished circuit-board assembly. For guidance on appropriate soldering, cleaning and drying procedures, refer to Tyco Electronics *Board Mounted Power Modules: Soldering and Cleaning Application Note*.

Through-Hole Lead-Free Soldering Information

The RoHS-compliant through-hole products use the SAC (Sn/Ag/Cu) Pb-free solder and RoHS-compliant components. They are designed to be processed through single or dual wave soldering machines. The pins have an RoHS-compliant finish that is compatible with both Pb and Pb-free wave soldering processes. A maximum preheat rate of 3°C/s is suggested. The wave preheat process should be such that the temperature of the power module board is kept below 210°C. For Pb solder, the recommended pot temperature is 260°C, while the Pb-free solder pot is 270°C max. Not all RoHS-compliant through-hole products can be processed with paste-through-hole Pb or Pb-free reflow process. If additional information is needed, please consult with your Tyco Electronics Power System representative for more details.

Layout Considerations

The QBW018 power module series are low profile in order to be used in fine pitch system card architectures. As such, component clearance between the bottom of the power module and the mounting board is limited. Avoid placing copper areas on the outer layer directly underneath the power module. Also avoid placing via interconnects underneath the power module.

For additional layout guide-lines, refer to the FLTR100V10 data sheet.

Mechanical Outline for QBW018A0B Through Hole Module

Dimensions are in inches and (millimeters).

Tolerances: x.xx in. ± 0.02 in. (x.x mm ± 0.5 mm) [unless otherwise indicated]

x.xxx in ± 0.010 in. (x.xx mm ± 0.25 mm)

TOP VIEW

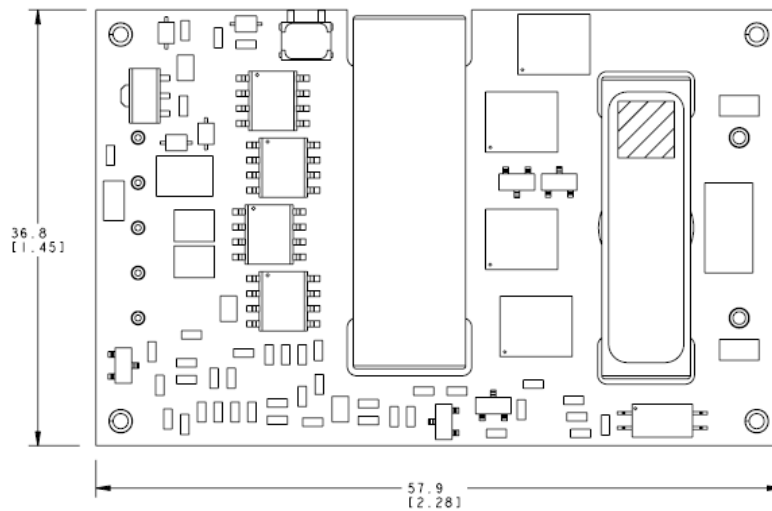

SIDE VIEW

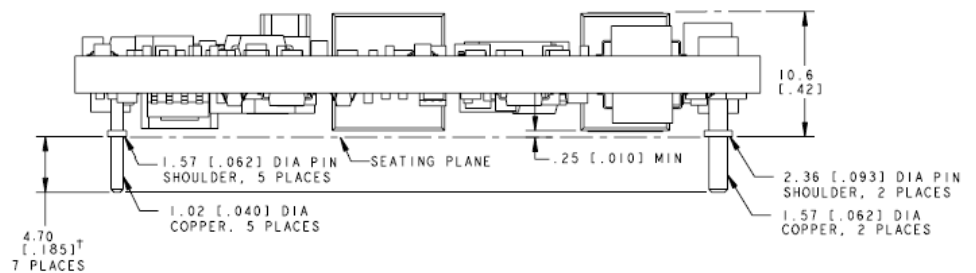

BOTTOM VIEW

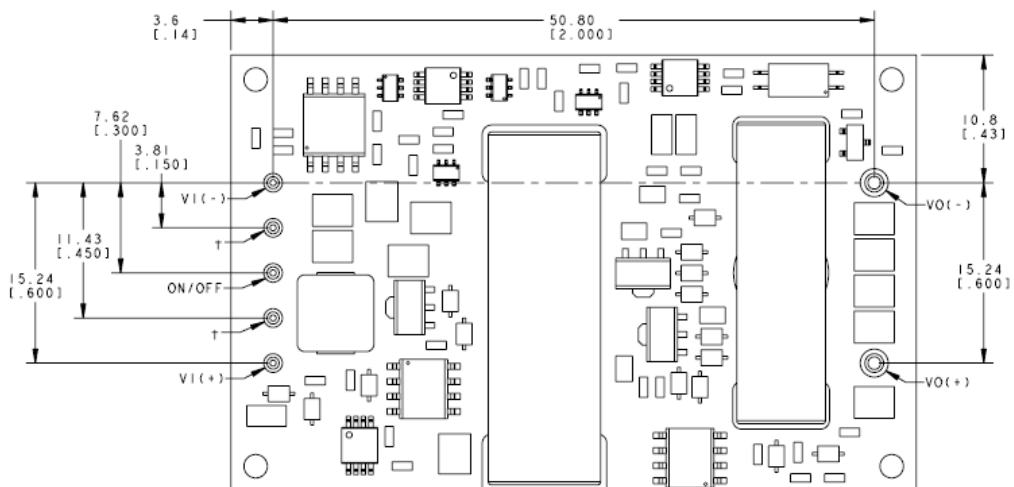

† - Optional pin/pin length shown in Table 2 Device Options.

Mechanical Outline for QBW018A-H (Baseplate version) Through Hole Module

Dimensions are in inches and (millimeters).

Tolerances: x.xx in. ± 0.02 in. (x.x mm ± 0.5 mm) [unless otherwise indicated]

x.xxx in ± 0.010 in. (x.xx mm ± 0.25 mm)

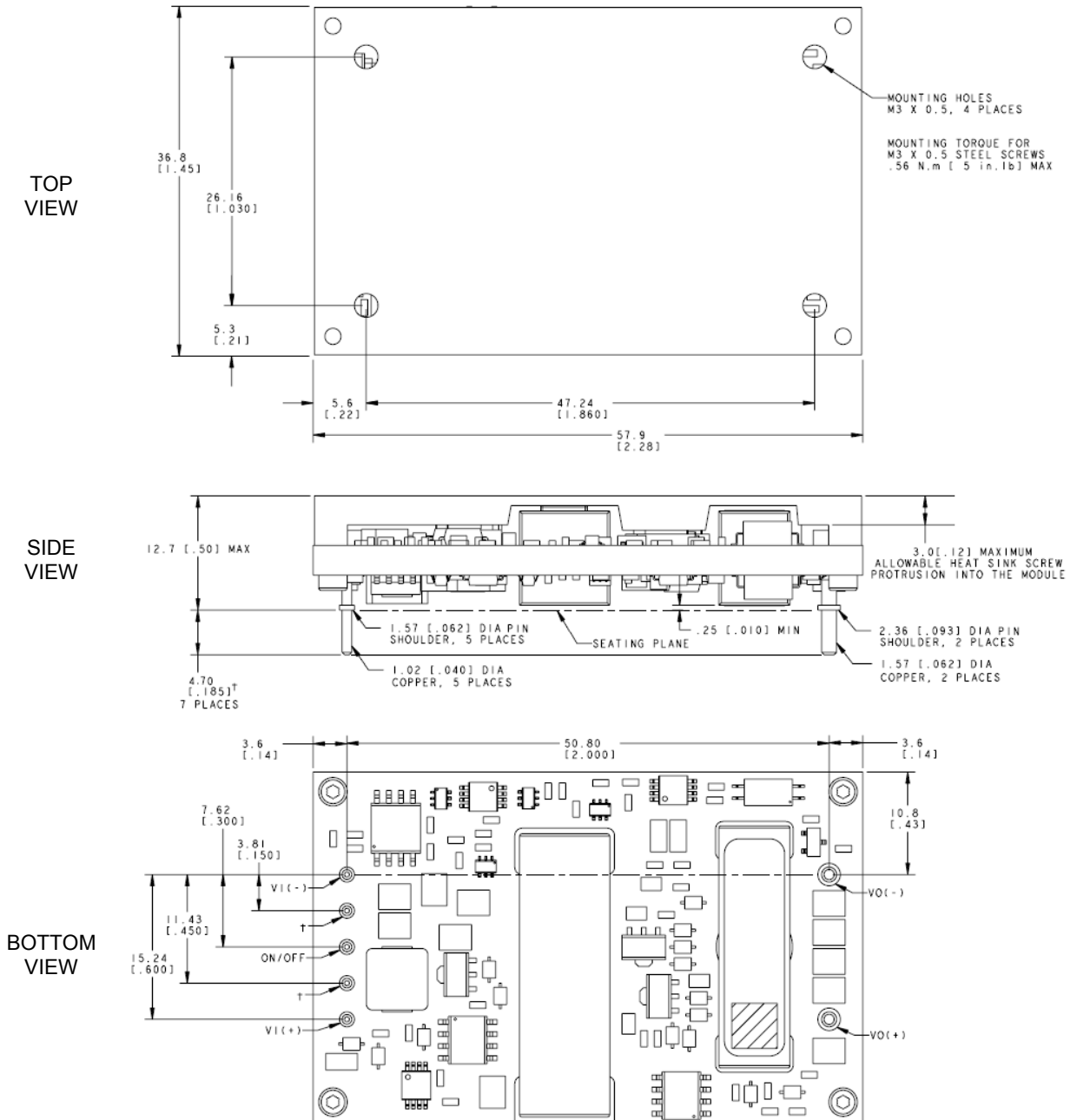

† - Optional pin/pin length shown in Table 2 Device Options.

Recommended Pad Layout

Dimensions are in inches and (millimeters).

Tolerances: x.xx in. \pm 0.02 in. (x.x mm \pm 0.5 mm) [unless otherwise indicated]

x.xxx in \pm 0.010 in. (x.xx mm \pm 0.25 mm)

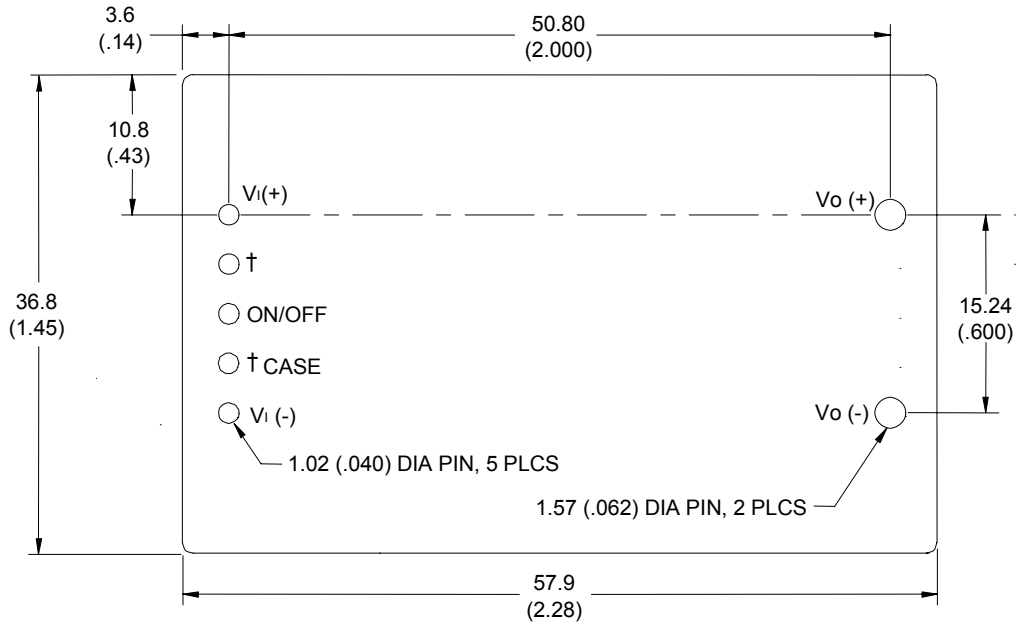

† - Optional pin/pin length shown in Table 2 Device Options.

Ordering Information

Please contact your Tyco Electronics' Sales Representative for pricing, availability and optional features.

Table 1. Device Codes

| Input Voltage | Output Voltage | Output Current | Efficiency | Connector Type | Product Codes | Comcodes |
|----------------|----------------|----------------|------------|----------------|------------------|-------------|
| 48V (36-75Vdc) | 12V | 18A | 93% | Through hole | QBW018A0B | 108994034 |
| 48V (36-75Vdc) | 12V | 18A | 93% | Through hole | QBW018A0B1 | 108989356 |
| 48V (36-75Vdc) | 12V | 18A | 93% | Through hole | QBW018A0B6 | CC109105500 |
| 48V (36-75Vdc) | 12V | 18A | 93% | Through hole | QBW018A0B41 | 108994496 |
| 48V (36-75Vdc) | 12V | 18A | 93% | Through hole | QBW018A0B61 | 108996575 |
| 48V (36-75Vdc) | 12V | 18A | 93% | Through hole | QBW018A0B641 | 108993374 |
| 48V (36-75Vdc) | 12V | 18A | 93% | Through hole | QBW018A0B-H | CC109102324 |
| 48V (36-75Vdc) | 12V | 18A | 93% | Through hole | QBW018A0B1-H | CC109101540 |
| 48V (36-75Vdc) | 12V | 18A | 93% | Through hole | QBW018A0B61-H | 108996583 |
| 48V (36-75Vdc) | 12V | 18A | 93% | Through hole | QBW018A0B-P | 108991064 |
| 48V (36-75Vdc) | 12V | 18A | 93% | Through hole | QBW018A0B71-BH | 108992252 |
| 48V (36-75Vdc) | 12V | 18A | 93% | Through hole | QBW018A0B741-BH | 108996476 |
| 48V (36-75Vdc) | 12V | 18A | 93% | Through hole | QBW018A0BZ | CC109107918 |
| 48V (36-75Vdc) | 12V | 18A | 93% | Through hole | QBW018A0B1Z | 108995247 |
| 48V (36-75Vdc) | 12V | 18A | 93% | Through hole | QBW018A0B61Z | CC109102027 |
| 48V (36-75Vdc) | 12V | 18A | 93% | Through hole | QBW018A0B641Z | CC109102274 |
| 48V (36-75Vdc) | 12V | 18A | 93% | Through hole | QBW018A0B1-HZ | CC109107901 |
| 48V (36-75Vdc) | 12V | 18A | 93% | Through hole | QBW018A0B61-HZ | CC109102010 |
| 48V (36-75Vdc) | 12V | 18A | 93% | Through hole | QBW018A0B741-BHZ | CC109114518 |

Table 2. Device Options

| Option | Suffix |
|--|--------|
| Negative remote on/off logic | 1 |
| Auto-restart | 4 |
| Pin Length: 3.68 mm ± 0.25mm , (0.145 in. ± 0.010 in.) | 6 |
| Case ground pin (offered with baseplate option only) | 7 |
| Pin Length: 2.79 mm ± 0.25mm , (0.110 in. ± 0.010 in.) | 8 |
| Base Plate option | -H |
| Active load sharing (Parallel Operation) | -P |
| RoHS Compliant | Z |

Note: Legacy device codes may contain a –B option suffix to indicate 100% factory Hi-Pot tested to the isolation voltage specified in the Absolute Maximum Ratings table. The 100% Hi-Pot test is now applied to all device codes, with or without the –B option suffix. Existing comcodes for devices with the –B suffix are still valid; however, no new comcodes for devices containing the –B suffix will be created.



World Wide Headquarters
Tyco Electronics Power Systems, Inc.
3000 Skyline Drive, Mesquite, TX 75149, USA
+1-800-843-7497
(Outside U.S.A.: **+1-972-284-2626**)
www.power.tycoelectronics.com
e-mail: techsupport1@tycoelectronics.com

Europe, Middle-East and Africa Headquarters

Tyco Electronics (UK) Ltd
Tel: +44 (0) 1344 469 300

Latin America, Brazil, Caribbean Headquarters

Tyco Electronics Power Systems
Tel: +56 2 209 8211

India Headquarters

Tyco Electronics Systems India Pte. Ltd.
Tel: +91 80 841 1633 x3001

Asia-Pacific Headquarters

Tyco Electronics Singapore Pte. Ltd.
Tel: +65 6416 4283

Tyco Electronics Corporation reserves the right to make changes to the product(s) or information contained herein without notice. No liability is assumed as a result of the use or application. No rights under any patent accompany the sale of any such product(s) or information.

© 2003 Tyco Electronics Power Systems, Inc., (Mesquite, Texas) All International Rights Reserved.

Document No: DS04-010 ver. 1.45
PDF name: qbus_qbw018a0b_ds.pdf