

## The Best Relaytion

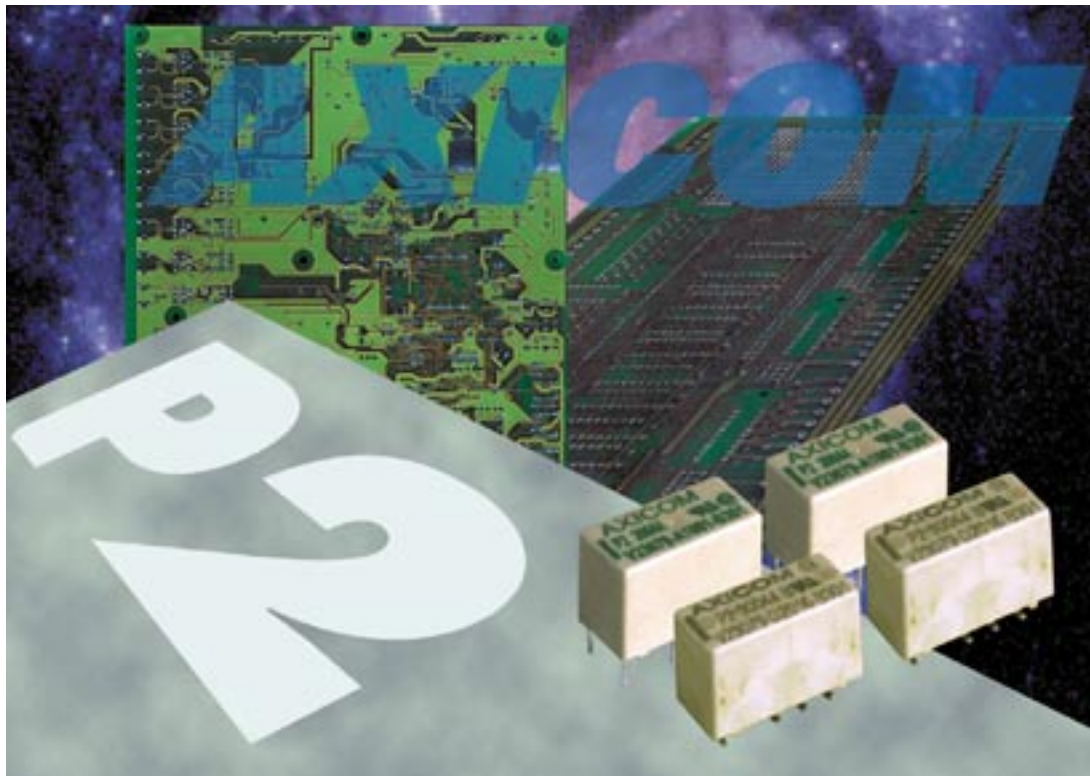

## P2 Relay



2 pole telecom relay, polarized,  
Through Hole Type (THT) or  
Surface Mount Technology (SMT),

Relay types:     non-latching with 1 coil  
                      latching with 2 coils  
                      latching with 1 coil

**Features**

- Standard telecom relay (ringing and test access)
- Slim line 15 x 7.5 mm, 0.590 x 0.295 inch
- Switching current 5 A
- 2 changeover contacts (2 form C / DPDT)
- Bifurcated contacts
- Immersion cleanable
- High sensitivity results in low nominal power consumption  
140 mW for non-latching and latching with 2 coils  
70 mW for latching with 1 coil
- For single coil version:
  - Surge voltage resistance between contact and coil for single coil version:
    - 2.5 kV (2 / 10 µsec) meets the Bellcore Requirement GR-1089
    - 1.5 kV (10 / 160 µsec) meets FCC Part 68

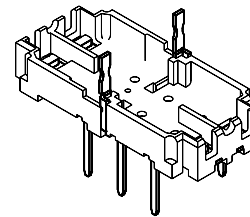
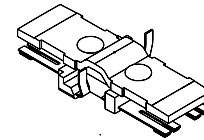
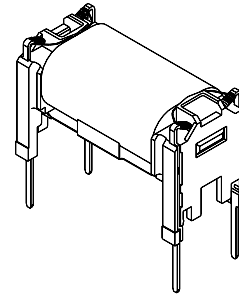
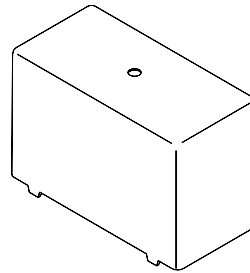

**Typical applications**

- Communications equipment  
linecard application (ringing and test access)  
PABX  
Voice over IP
- Office equipment
- Measurement and control equipment
- Automotive equipment  
CAN bus, keyless entry, speaker switch
- Medical equipment
- Consumer electronics  
Set Top Boxes, HiFi

**Insulation category:**

Supplementary insulation according IEC / EN 60950	
Working voltage	≥ 300 Vrms
Mains supply voltage	≥ 250 Vrms
Repetitive peak voltage	2500 V
Pollution degree:	Internal: 1 External: 2
Flammability classification:	V-0
Maximum operating temperature:	85 °C

**Options**

- 1500 Vrms between open contacts



UL 508     File No. E111441  
UL 60950



IEC 61811-54:03  
(QC 160504)

IEC/EN60950 IEC Ref. Cert. No. CH 2171

**European Directive conformance:**

P2 relay product conformance according to:

- Directive 2000/53/EC: ELV (End of Life of Vehicles)
- Directive 2002/95/EC: ROHS (Restrictions of the use of certain hazardous substances in electrical and electronic equipment)

Compliance is evidenced by written declaration from all raw material suppliers.

Tyco Electronics AXICOM only has responsibility for the proper processing of these materials.

Confirmation is valid for date codes ≥ 0427

Dimensions

	THT V23079-x1xxx-B301 standard coil		THT V23079-x2xxx-B301 overmolded coil		SMT long terminals V23079-x1xxx-B301 standard coil		SMT long terminals V23079-x2xxx-B301 overmolded coil		SMT short terminals V23079-x1xxx-B301 standard coil		SMT short terminals V23079-x2xxx-B301 overmolded coil	
	mm	inch	mm	inch	mm	inch	mm	inch	mm	inch	mm	inch
L	14.5 ± 0.1	0.570 ± 0.004	14.6 ± 0.1	0.575 ± 0.004	14.5 ± 0.1	0.570 ± 0.004	14.6 ± 0.1	0.575 ± 0.004	14.5 ± 0.1	0.570 ± 0.004	14.6 ± 0.1	0.575 ± 0.004
W	7.2 ± 0.1	0.283 ± 0.004	7.2 ± 0.1	0.283 ± 0.004	7.2 ± 0.1	0.283 ± 0.004	7.2 ± 0.1	0.283 ± 0.004	7.2 ± 0.1	0.283 ± 0.004	7.2 ± 0.1	0.283 ± 0.004
H	9.8 ± 0.1	0.385 ± 0.004	9.5 ± 0.1	0.374 ± 0.004	10.4 ± 0.15	0.409 ± 0.006	9.9 ± 0.1	0.390 ± 0.004	10.4 ± 0.15	0.409 ± 0.006	9.9 ± 0.1	0.390 ± 0.004
T	3.25 - 0.25	0.128 - 0.010	3.25 - 0.25	0.128 - 0.010	N/A	N/A	N/A	N/A	N/A	N/A	N/A	N/A
T1	N/A	N/A	N/A	N/A	5.52 ± 0.15	0.217 ± 0.006	5.52	0.217 ± 0.006	5.52	0.217 ± 0.006	5.52	0.217 ± 0.006
T2	N/A	N/A	N/A	N/A	9.4 ± 0.15	0.370 ± 0.006	9.4 ± 0.15	0.370 ± 0.006	7.4 ± 0.15	0.291 ± 0.006	7.4 ± 0.15	0.291 ± 0.006
Tw	0.5 ± 0.05	0.020 ± 0.002	0.5 ± 0.05	0.020 ± 0.002	0.5 ± 0.05	0.020 ± 0.002	0.5 ± 0.05	0.020 ± 0.002	0.5 ± 0.05	0.020 ± 0.002	0.5 ± 0.05	0.020 ± 0.002
S	0.55 - 0.15	0.022 - 0.006	0.45	0.018 ± 0.002	N/A	N/A	N/A	N/A	N/A	N/A	N/A	N/A

THT Version

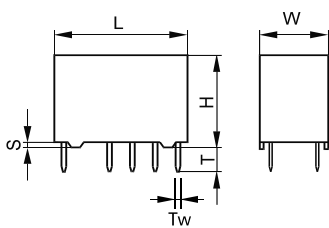

SMT Version

Long terminals

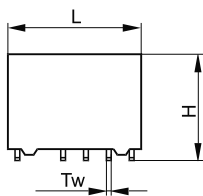

Short terminals

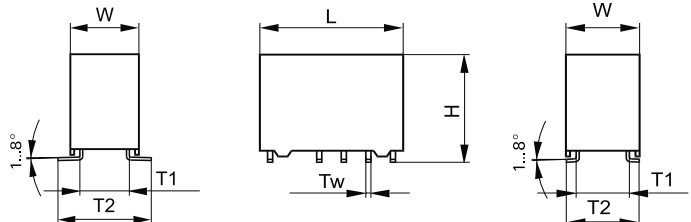

Mounting hole layout

View onto the component side of the PCB

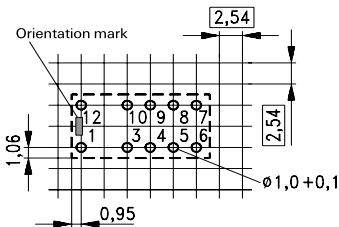

Note: Hole for pin 6 and 7 only for latching with 2 coils  
Basic grid 2.54 mm

Solder pad layout

View onto the component side of the PCB

Long terminals

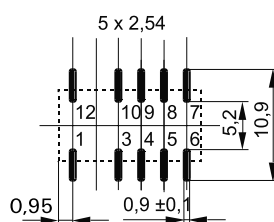

Note: Solder pad for pin 6 and 7 only for latching with 2 coils

Short terminals

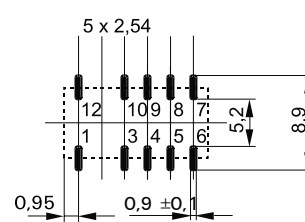

Note: Solder pad for pin 6 and 7 only for latching with 2 coils

Terminal assignment

Relay - top view

Non-latching type, not energized condition

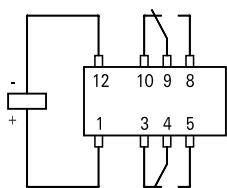

Latching type, 1 coil reset condition

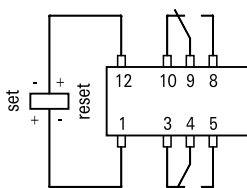

Latching type, 2 coils reset condition

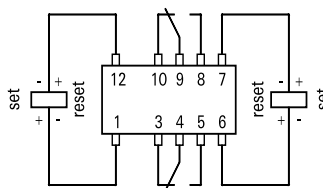

Contacts in reset position. Both coils can be used either as set or reset coil.

## Coil Data (values at 23 °C)

## Ordering Information

Nominal voltage $U_{nom}$	Operate/set voltage range		Release/ reset voltage Minimum	Coil power	Coil Resistance	Relay code	Tyco part number
	Minimum voltage $U_{min}$	Maximum voltage $U_{max}$					
Vdc	Vdc	Vdc	Vdc	mW	$\Omega / \pm 10\%$		

## THT, non-latching, standard coil

3	2.25	6.50	0.30	140	64.3	V23079-A1008-B301	2-1393788-2
4	3.00	8.70	0.40	140	114	V23079-A1016-B301	2-1393788-9
4.5	3.38	9.80	0.45	140	145	V23079-A1011-B301	2-1393788-4
5	3.75	10.90	0.50	140	178	V23079-A1001-B301	0-1393788-3
6	4.5	13.00	0.60	140	257	V23079-A1002-B301	0-1393788-8
9	6.75	19.60	0.90	140	578	V23079-A1006-B301	2-1393788-0
12	9.00	26.15	1.20	140	1029	V23079-A1003-B301	1-1393788-1
24	18.00	52.30	2.40	140	4114	V23079-A1005-B301	1-1393788-6

## THT, non-latching, overmolded coil

3	2.25	6.50	0.30	140	64.3	V23079-A2008-B301	6-1419120-6
4.5	3.38	9.80	0.45	140	145	V23079-A2011-B301	3-1393789-9
5	3.75	10.90	0.50	140	178	V23079-A2001-B301	3-1393789-5
6	4.5	13.00	0.60	140	257	V23079-A2002-B301	3-1393789-6
9	6.75	19.60	0.90	140	578	V23079-A2006-B301	3-1393789-8
12	9.00	26.15	1.20	140	1029	V23079-A2003-B301	3-1393789-7

## THT, latching, 2 standard coils

3	2.25	6.50	2.25	140	64.3	V23079-B1208-B301	4-1393788-1
4.5	3.38	9.80	3.38	140	145	V23079-B1211-B301	4-1393788-2
5	3.75	10.90	3.75	140	178	V23079-B1201-B301	3-1393788-3
6	4.5	13.00	4.50	140	257	V23079-B1202-B301	3-1393788-5
9	6.75	19.60	6.75	140	578	V23079-B1206-B301	3-1393788-9
12	9.00	26.15	9.00	140	1029	V23079-B1203-B301	3-1393788-6
24	18.00	52.30	18.00	140	4114	V23079-B1205-B301	3-1393788-7

## THT, latching, 1 standard coil

3	2.25	9.20	2.25	70	128	V23079-C1108-B301	5-1393788-3
4.5	3.38	13.85	3.38	70	289	V23079-C1111-B301	5-1393788-4
5	3.75	15.33	3.75	70	357	V23079-C1101-B301	4-1393788-5
6	4.5	18.50	4.50	70	514	V23079-C1102-B301	4-1393788-7
9	6.75	27.75	6.75	70	1157	V23079-C1106-B301	5-1393788-1
12	9.00	37.00	9.00	70	2057	V23079-C1103-B301	4-1393788-8
24	18.00	74.00	18.00	70	8228	V23079-C1105-B301	5-1393788-0

## SMT, long pins, non-latching, standard coil

3	2.25	6.50	0.30	140	64.3	V23079-D1008-B301	6-1393788-1
4.5	3.38	9.80	0.45	140	145	V23079-D1011-B301	6-1393788-2
5	3.75	10.90	0.50	140	178	V23079-D1001-B301	5-1393788-5
6	4.5	13.00	0.60	140	257	V23079-D1002-B301	5-1393788-6
9	6.75	19.60	0.90	140	578	V23079-D1006-B301	5-1393788-9
12	9.00	26.15	1.20	140	1029	V23079-D1003-B301	5-1393788-7
24	18.00	52.30	2.40	140	4114	V23079-D1005-B301	5-1393788-8

## SMT, long pins, non-latching, overmolded coil

3	2.25	6.50	0.30	140	64.3	V23079-D2008-B301	4-1393789-7
4.5	3.38	9.80	0.45	140	145	V23079-D2011-B301	4-1393789-8
5	3.75	10.90	0.50	140	178	V23079-D2001-B301	4-1393789-3
6	4.5	13.00	0.60	140	257	V23079-D2002-B301	4-1393789-4
9	6.75	19.60	0.90	140	578	V23079-D2006-B301	4-1393789-6
12	9.00	26.15	1.20	140	1029	V23079-D2003-B301	4-1393789-5

Further coil versions are available on request.

## Coil Data (values at 23 °C)

## Ordering Information

Nominal voltage $U_{nom}$	Operate/set voltage range		Release/ reset voltage Minimum	Coil power	Coil Resistance	Relay code	Tyco part number
	Minimum voltage $U_{min}$ Vdc	Maximum voltage $U_{max}$ Vdc					

## SMT, long pins, latching, 2 standard coils

2.4	1.80	5.20	1.80	140	41.1	V23079-E1218-B301	0-1422007-5
3	2.25	6.50	2.25	140	64.3	V23079-E1208-B301	7-1393788-1
4.5	3.38	9.80	3.38	140	145	V23079-E1211-B301	7-1393788-2
5	3.75	10.90	3.75	140	178	V23079-E1201-B301	6-1393788-8
6	4.5	13.00	4.5	140	257	V23079-E1202-B301	0-1393789-5
9	6.75	19.60	6.75	140	578	V23079-E1206-B301	0-1393789-9
12	9.00	26.15	9.00	140	1029	V23079-E1203-B301	6-1393788-9
24	18.00	52.30	18.00	140	4114	V23079-E1205-B301	7-1393788-0

## SMT, long pins, latching, 1 standard coil

3	2.25	9.20	2.25	70	128	V23079-F1108-B301	7-1393788-5
4.5	3.38	13.85	3.38	70	289	V23079-F1111-B301	1-1393789-4
5	3.75	15.33	3.75	70	357	V23079-F1101-B301	7-1393788-3
6	4.5	18.50	4.50	70	514	V23079-F1102-B301	1-1393789-0
9	6.75	27.75	6.75	70	1157	V23079-F1106-B301	1-1393789-2
12	9.00	37.00	9.00	70	2057	V23079-F1103-B301	7-1393788-4
24	18.00	74.00	18.00	70	8228	V23079-F1105-B301	1-1393789-1

## SMT, short pins, non-latching, standard coil

3	2.25	6.50	0.30	140	64.3	V23079-G1008-B301	8-1393788-0
4.5	3.38	9.80	0.45	140	145	V23079-G1011-B301	1-1393789-7
5	3.75	10.90	0.50	140	178	V23079-G1001-B301	7-1393788-6
6	4.5	13.00	0.60	140	257	V23079-G1002-B301	1-1393789-5
9	6.75	19.60	0.90	140	578	V23079-G1006-B301	1-1393789-6
12	9.00	26.15	1.20	140	1029	V23079-G1003-B301	7-1393788-7
24	18.00	52.30	2.40	140	4114	V23079-G1005-B301	7-1393788-8

## SMT, short pins, non-latching, overmolded coil

3	2.25	6.50	0.30	140	64.3	V23079-G2008-B301	5-1393789-4
4	3.0	8.7	0.40	140	114	V23079-G2016-B301	0-1393790-5
4.5	3.38	9.80	0.45	140	145	V23079-G2011-B301	5-1393789-5
5	3.75	10.90	0.50	140	178	V23079-G2001-B301	4-1393789-9
6	4.5	13.00	0.60	140	257	V23079-G2002-B301	5-1393789-0
9	6.75	19.60	0.90	140	578	V23079-G2006-B301	5-1393789-3
12	9.00	26.15	1.20	140	1029	V23079-G2003-B301	5-1393789-1

## SMT, short pins, latching, 2 standard coils

3	2.25	6.50	2.25	140	64.3	V23079-H1208-B301	2-1393789-4
4.5	3.38	9.80	3.38	140	145	V23079-H1211-B301	8-1393788-4
5	3.75	10.90	3.75	140	178	V23079-H1201-B301	2-1393789-0
6	4.5	13.00	4.5	140	257	V23079-H1202-B301	2-1393789-1
9	6.75	19.60	6.75	140	578	V23079-H1206-B301	2-1393789-3
12	9.00	26.15	9.00	140	1029	V23079-H1203-B301	8-1393788-3
24	18.00	52.30	18.00	140	4114	V23079-H1205-B301	2-1393789-2

## SMT, short pins, latching, 1 standard coil

3	2.25	9.20	2.25	70	128	V23079-J1108-B301	2-1393789-9
4.5	3.38	13.85	3.38	70	289	V23079-J1111-B301	3-1393789-0
5	3.75	15.33	3.75	70	357	V23079-J1101-B301	2-1393789-5
6	4.5	18.50	4.50	70	514	V23079-J1102-B301	2-1393789-6
12	9.00	37.00	9.00	70	2057	V23079-J1103-B301	2-1393789-7
24	18.00	74.00	18.00	70	8228	V23079-J1105-B301	2-1393789-8

Further coil versions are available on request.

**Ordering Code**



Identification of the Miniature Relay P2

Relay type

THT version

- A = non-latching, 1 coil
- B = latching, 2 coils
- C = latching, 1 coil

SMT version with long terminals

- D = non-latching, 1 coil
- E = latching, 2 coils
- F = latching, 1 coil

SMT version with short terminals

- G = non-latching, 1 coil
- H = latching, 2 coils
- J = latching, 1 coil

Coil type

- 1 = standard coil
  - 2 = overmolded coil
- (only monostable versions, i.e. relay type A, D, G)

Coil number

Monostable, 1 coil

- 008 = 3 V nominal voltage
- 011 = 4.5 V
- 001 = 5 V
- 002 = 6 V
- 006 = 9 V
- 003 = 12 V
- 005 = 24 V

Latching, 1 coil

- 108 = 3 V nominal voltage
- 111 = 4.5 V
- 101 = 5 V
- 102 = 6 V
- 106 = 9 V
- 103 = 12 V
- 105 = 24 V

Latching, 2 coils

- 208 = 3 V nominal voltage
- 211 = 4.5 V
- 201 = 5 V
- 202 = 6 V
- 206 = 9 V
- 203 = 12 V
- 205 = 24 V

Contact arrangement / material

- B301 = 2 changeover contacts; silver nickel, gold-plated, against silver nickel, gold-plated
- B201 = 2 changeover contacts; silver palladium, gold-plated, against silver palladium

Ordering example: V23079-D2001-B301

Miniature relay P2 SMT version with long terminals (overmolded coil), non-latching, 1 coil, 5 V nominal voltage, 2 changeover contacts, silver nickel contacts

**Coil operating range**

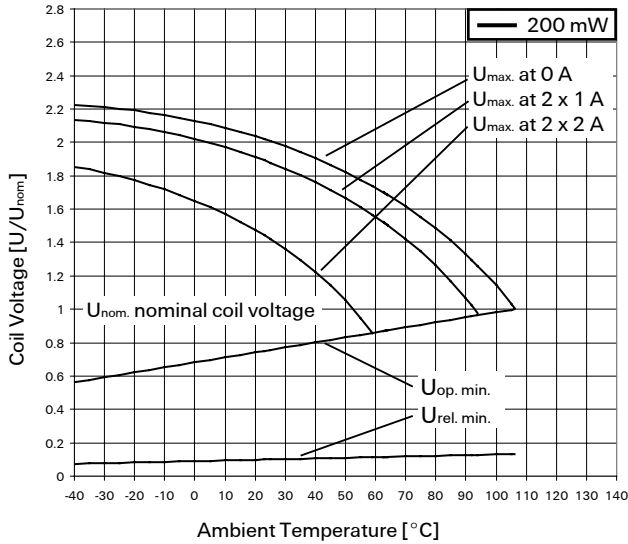
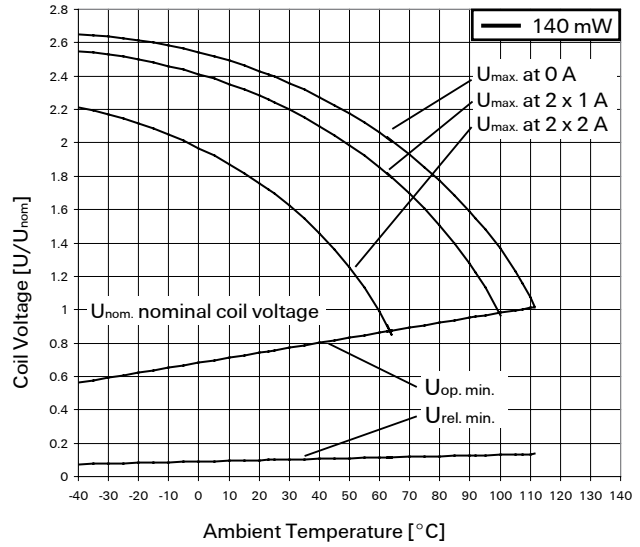
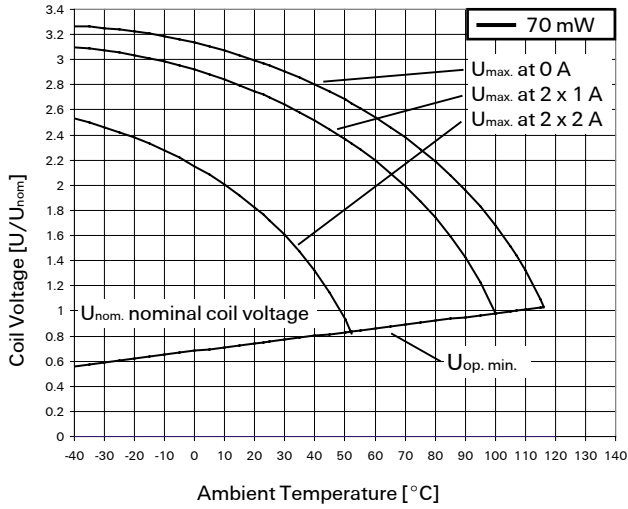

- $U_{nom}$  = Nominal coil voltage
- $U_{max.}$  = Upper limit of the operative range of the coil voltage (limiting voltage) when coils are continuously energized
- $U_{op. min.}$  = Lower limit of the operative range of the coil voltage (reliable operate voltage)  
For latching relays  $U_{set min.}$  resp.  $U_{reset min.}$
- $U_{rel. min.}$  = Lower limit of the operative range of the coil voltage (reliable release voltage)

**Contact Data**

Number of contacts and type	2 changeover contacts
Contact assembly	Bifurcated contacts
Contact material	Silver nickel, gold-covered
Limiting continuous current at max. ambient temperature	2 A
Maximum switching current	5 A
Maximum swichting voltage	220 Vdc 250 Vac
Maximum switching capacity	60 W, 62.5 VA
Thermoelectric potential	< 10 $\mu$ V
Minimum switching voltage	100 $\mu$ V
Initial contact resistance / measuring condition: 10 mA / 20 mV	< 50 m $\Omega$
Electrical endurance	at 12 V / 10 mA typ. $5 \times 10^7$ operations at 6 V / 100 mA typ. $1 \times 10^7$ operations at 60 V / 500 mA typ. $5 \times 10^5$ operations at 30 V / 1000 mA typ. $1 \times 10^6$ operations at 30 V / 2000 mA typ. $2 \times 10^5$ operations
Mechanical endurance	typ. $10^8$ operations
UL contact ratings	220 Vdc / 0.24 A - 60 W 125 Vdc / 0.24 A - 30 W 250 Vac / 0.25 A - 62.5 VA 125 Vac / 0.5 A - 62.5 VA 30 Vdc / 2 A - 60 W

**Max. DC load breaking capacity**

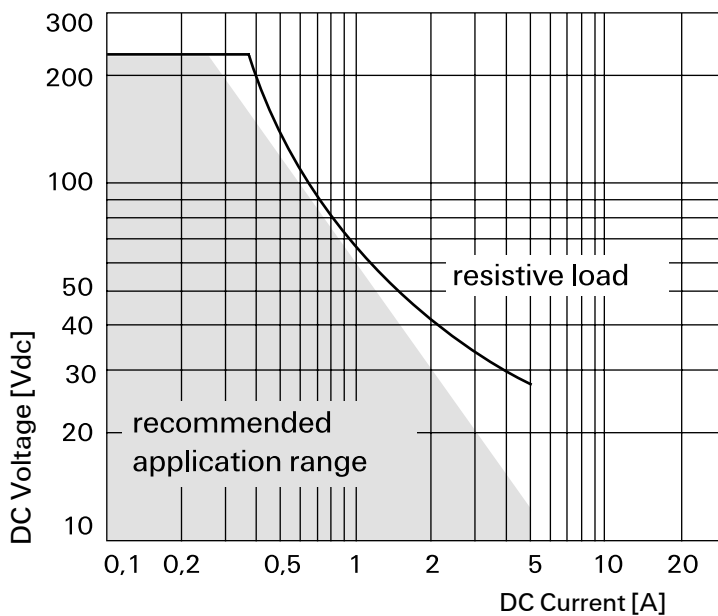



**Insulation**

Insulation resistance at 500 VDC	> 10 <sup>9</sup> Ω
Dielectric test voltage (1 min)	
between coil and contacts (Relay with 1 coil)	1500 Vrms
between adjacent contact sets	1000 Vrms
between open contacts	1000 Vrms (1500 Vrms on request)
Surge voltage resistance	
according to Bellcore TR-NWT-001089 (2 / 10 μs)	
between coil and contacts (Relay with 1 coil)	2500 V
between adjacent contact sets	2500 V
between open contacts	2000 V
according to FCC 68 (10 / 160 μs)	
between coil and contacts (Relay with 1 coil)	1500 V
between adjacent contact sets	1500 V
between open contacts	1500 V
Insulation according to IEC / EN 60950	Basic insulation
Clearance	1.3 mm
Creepage distance	2.5 mm

**High Frequency Data**

Capacitance	
between coil and contacts	max. 2 pF
between adjacent contact sets	max. 1.5 pF
between open contacts	max. 1 pF
RF Characteristics	
Isolation at 100 / 900 MHz	-39.0 dB / -20.7 dB
Insertion loss at 100 / 900 MHz	-0.02 dB / -0.27 dB
V.S.W.R. at 100 / 900 MHz	1.04 / 1.40

**General data**

Operate time at $U_{nom}$ typ. / max.	3 ms / 5 ms
Reset time (latching) at $U_{nom}$ , typ. / max.	3 ms / 5 ms
Release time without diode in parallel (non-latching), typ. / max.	2 ms / 4 ms
Release time with diode in parallel (non-latching), typ. / max.	4 ms / 6 ms
Bounce time at closing contact, typ. / max.	1 ms / 3 ms
Maximum switching rate without load	50 operations/s
Ambient temperature	-40° C ... +85° C
Thermal resistance	< 125 K/W
Maximum permissible coil temperature	125° C
Vibration resistance (function)	35 G 10 to 1000 Hz
Shock resistance, half sinus, 11 ms	50 G (function) 150 G (damage)
Degree of protection / Environmental protection	immersion cleanable, IP 67 / RT III
Needle flame test	application time 20 s, burning time < 15 s
Mounting position	any
Processing information	Ultrasonic cleaning is not recommended
Weight (mass)	max. 2.8 g
Terminal surface	SnCu 0,7
Moisture sensitive level (JEDEC J-STD-020B) - SMD types	MSL 3
Resistance to soldering heat	260° C / 10 s

All data refers to 23° C unless otherwise specified.

### Recommended soldering conditions

Soldering conditions according CECC 00802

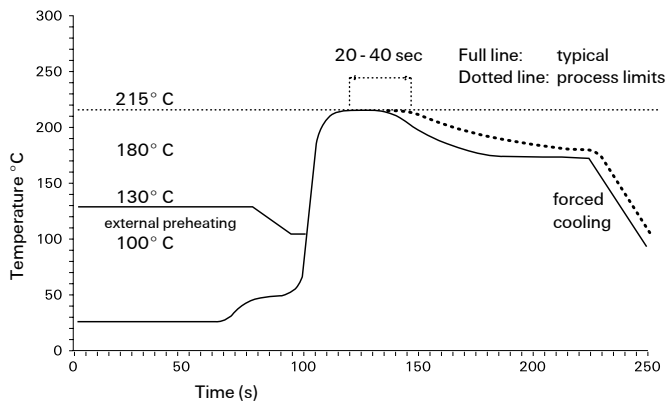

Vapor Phase Soldering: Temperature/Time Profile (Lead Temperature)

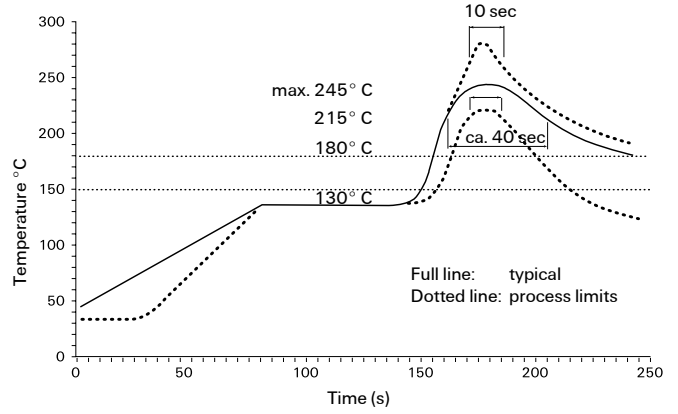

Infrared Soldering: Temperature/Time Profile (Lead Temperature)

Packing

Dimensions in mm

Tube for THT version - 50 relays per tube, 2000 relays per box

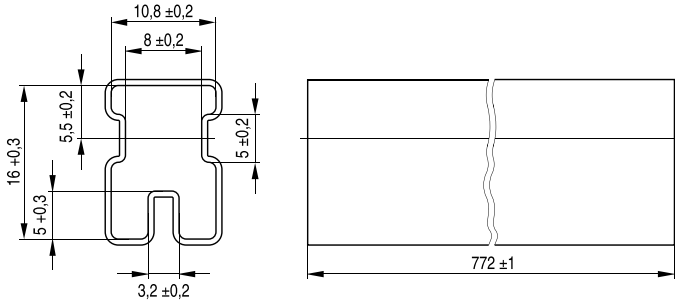

Tape and reel for SMT version with long terminals - 400 relays per reel, 2000 relays per box

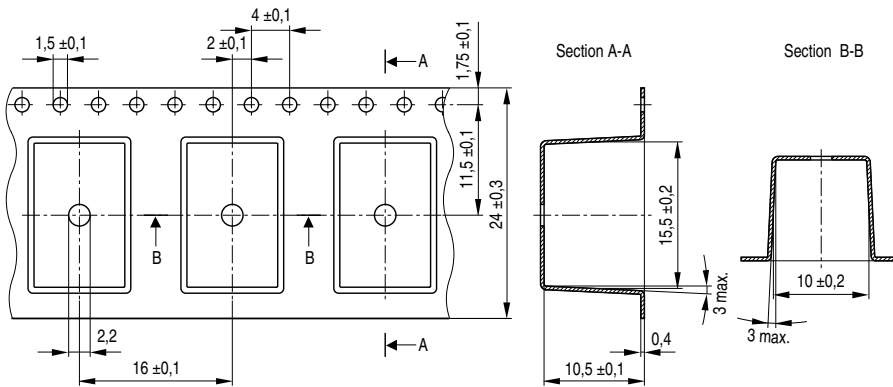

Tape and reel for SMT version with short terminals - 500 relays per reel, 2500 relays per box

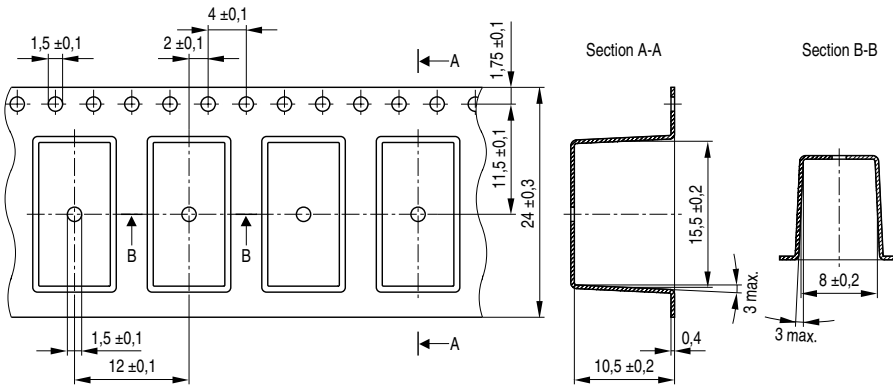

Reel dimension

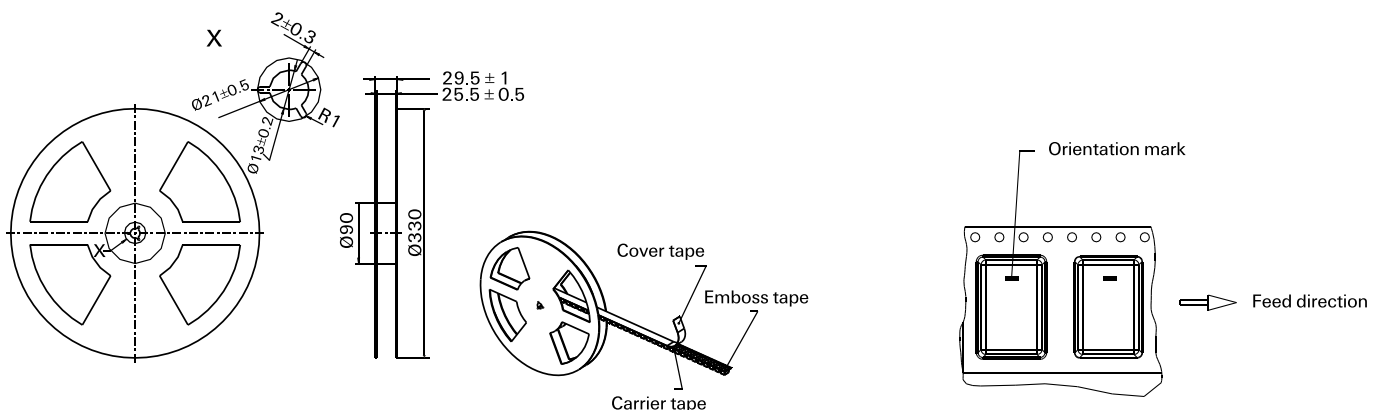

**Option: high dielectric between open contacts (overmolded coil)**

This supplementary data sheet refers to the basic data sheet of the P2 relay series (V23079) with following additions:

- Dielectric strength 1500 V<sub>rms</sub> between open contacts - as well as between coil and contacts and between adjacent contact sets
- Only non-latching types available
- SMT version with short terminals as preferred type
- mechanical and electrical endurance typ. 10<sup>6</sup> operations

**Dimensions**

SMT short terminals V23079-G2xxx-X0xx overmolded coil		
	mm	inch
L	14.5 ± 0.1	0.570 ± 0.004
W	7.2 ± 0.1	0.283 ± 0.004
H	9.9 ± 0.1	0.390 ± 0.004
T	N/A	N/A
T1	5.52	0.217 ± 0.006
T2	7.4 ± 0.15	0.291 ± 0.006
Tw	0.5 ± 0.05	0.020 ± 0.002
S	N/A	N/A

**SMT Version**

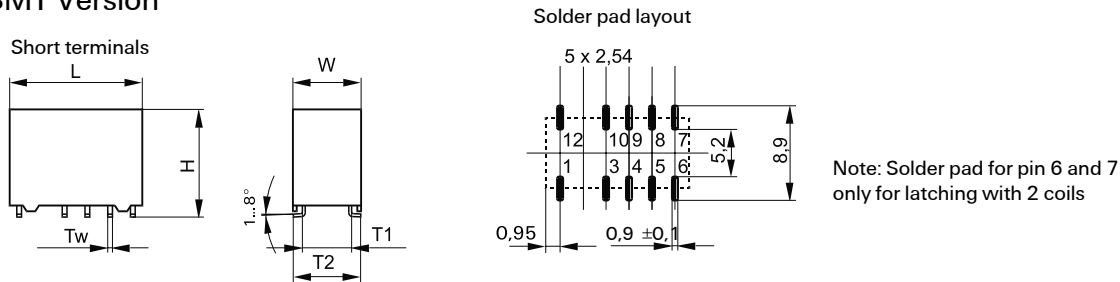

**Coil Data (values at 23 °C)**

**Ordering Information**

Nominal voltage <i>U<sub>nom</sub></i>	Operate/set voltage range		Release/ reset voltage Minimum	Coil power	Coil Resistance	Relay code	Tyco part number
	Minimum voltage <i>U<sub>min</sub></i>	Maximum voltage <i>U<sub>max</sub></i>					
Vdc	Vdc	Vdc	Vdc	mW	Ω / ± 10 %		

**non-latching  
1 coil**

5	3.75	10.1	0.50	200	125	V23079-G2001-X071	0-1422006-1
6	4.50	12.1	0.60	200	180	V23079-G2002-X072	0-1422006-2
9	6.75	18.2	0.90	200	405	V23079-G2006-X073	0-1422006-3
12	9.00	24.2	1.20	200	720	V23079-G2003-X074	0-1422006-4

## IM Relays

4<sup>th</sup> generation slim line – low profile polarized 2 c/o telecom relay with bifurcated contacts, available as non latching or latching relay with 1 coil. Nominal voltage range from 1.5... 24 V, coil power consumption of 140... 200 mW, latching relays with 1 coil 100 mW. The IM relay is available as through hole and surface mount type (J-Legs and Gull Wings) and capable to switch loads up to 60 W/62,5 VA. Dielectric strength fulfills the Bellcore requirements according GR 1089 (2,5 kV – 2 / 10 µs) and FCC part 68 (1,5 kV – 10 / 160 µs). The IM relay is CECC/IECQ approved and certified in accordance with IEC/EN 60950 and UL1950. Dimensions approx. 10 x 6 mm board space and 5,65 mm height.

## P2 Relays

3<sup>rd</sup> generation polarized 2 c/o telecom relay with bifurcated contacts, available as non latching or latching relay with 1 or 2 coils. Nominal voltage range from 3 ... 24 V, coil power consumption 140 mW, latching relays with 1 coil 70 mW. The P2 Relay is available as through hole or surface mount type and capable to switch currents up to 5 A. Dielectric strength fulfills the Bellcore requirements according GR 1089 (2,5 kV – 2 / 10 µs) and FCC part 68 (1,5 kV – 10 / 160 µs). Dimensions approx. 15 x 7,5 mm board space and 10 mm height.

## FX Relays

3<sup>rd</sup> generation polarized 2 c/o telecom relay with bifurcated contacts, available as non latching or latching relay with 1 coil. Nominal voltage range from 3 ... 48 V, coil power consumption of 80 ... 260 mW for the high sensitive version, 140... 300 mW for the standard version, latching relays with 1 coil 100 mW. The FX2 relay is available as through hole type and capable to switch loads up to 60 W/62,5 VA. Dielectric strength fulfills the Bellcore requirements according GR 1089 (2,5 kV – 2 / 10 µs) and FCC part 68 (1,5 kV – 10 / 160 µs). The FX2 is CECC/IECQ approved and certified in accordance with IEC/EN 60950 and UL1950. Dimensions approx. 15 x 7,5 mm board space and 10,7 mm height.

## FT2 / FU2 Relays

3<sup>rd</sup> generation non polarized, non latching 2 c/o telecom relay with bifurcated contacts. Nominal voltage range from 3 ... 48 V, coil power consumption 200 ... 300 mW. Most sensitive 48 V relay. Available as through hole and surface mount type. Dielectric strength fulfills the Bellcore requirements according GR 1089 (2,5 kV – 2 / 10 µs) and FCC part 68 (1,5 kV – 10 / 160 µs). The FT2/FU2 is CECC/IECQ approved and certified in accordance with IEC/EN 60950 and UL1950. Dimensions approx. 15 x 7,5 mm board space and 10 mm height.

## FP2 Relays

3<sup>rd</sup> generation polarized 2 c/o telecom relay with bifurcated contacts, available as non latching or latching relay with 1 or 2 coils. Nominal voltage range from 3 ... 48 V, coil power consumption of 80 ... 260 mW for the high sensitive version, 140... 300 mW for the standard version, latching relays with 1 coil 100 mW.. The FP2 Relay is available as through hole type and capable to switch loads up to 30 W/62,5 VA. Dielectric strength fulfills FCC part 68 (1,5 kV – 10 / 160 µs). The FP2 is CECC/IECQ approved. Dimensions approx. 14 x 9 mm board space and 5 mm height.

## MT2 / MT4

2<sup>nd</sup> generation non polarized, non latching 2 c/o and 4 c/o telecom and signal relay with bifurcated contacts. Nominal voltage range from 4.5 ... 48 V, coil power consumption 150/200/300/400 and 550 mW, and 300 mW (MT4). Dielectric strength fulfills the requirements according FCC part 68 (1,5 kV – 10 / 160 µs) for both and the Bellcore requirements according GR 1089 (2,5 kV – 2 / 10 µs) the MT4 only. Dimensions MT2 approx. 20 x 10 mm board space and 11 mm height, MT4 approx. 20 x 15 mm board space and 11 mm height.

## D2n Relays

2<sup>nd</sup> generation non polarized 2 c/o relay for telecom and various other applications. Nominal voltage range from 3 ... 48 V, coil power consumption from 150 ... 500 mW. The D2n relay is capable to switch currents up to 3 A. Dielectric strength fulfills the requirements according FCC part 68 (1,5 kV – 10 / 160 µs). Dimensions approx. 20 x 10 mm board space and 11,5 mm height.

## P1 Relays

Extremely sensitive, polarized 1 c/o relay with bifurcated contacts for a wide range of applications, available as non latching or latching relay with 1 or 2 coils. Nominal voltage range from 3 ... 24 V, coil power consumption 65 mW, latching relays with 1 coil 30 mW. The P1 relay is available as through hole or surface mount type and capable to switch currents up to 1 A. Dielectric strength fulfills the requirements according FCC part 68 (1,5 kV – 10 / 160 µs). Dimensions approx. 13 x 7,6 mm board space and 7 mm height for THT or 8 mm height for SMT version.

## W11 Relays

Low cost, non polarized 1 c/o relay for various applications. Nominal voltage range from 3 ... 24 V, coil power consumption 450 mW, sensitive versions 200 mW. The W11 relay is capable to switch currents up to 3 A. Dielectric strength 1000 Vrms. Dimensions approx. 15,6 x 10,6 mm board space and 11,5 mm height.

## Reed Relays

High sensitive, non polarized relay for telecom and various other applications, available with 1 n/o, 2 n/o or 1c/o contacts. Nominal voltage range from 5 ... 24 V, coil power consumption 50...280 mW for 1 n/o and 125 ... 280 mW for 2 n/o or 1 c/o versions. Reedrelays are available in DIP or SIL housing and capable to switch currents up to 0,5 A. Integrated diode and/or electrostatic shield optional. Dielectric strength 1500 Vdc. Dimensions approx. 19,3 x 7 mm board space and 5 ... 7,5 mm height for DIP or 19,8 x 5 mm board space and 7,8 mm height for SIL version.

## Cradle Relays

Extremely reliable and mature relay family of 1<sup>st</sup> generation for various signal switching applications. Available as non polarized, polarized / latching and relay with AC coil. The benefit is the possibility of combining various contact sets from 1 up to 6 poles, single and bifurcated contacts, different contact materials with a coil voltage range from 1,5 Vdc to 220 Vac. Cradle relays are available as dust protected and hermetically sealed versions, with plug in or solder terminals and are capable to switch currents up to 5 A. Forcibly terminated (linked) contact sets optional. Dielectric strength 500 Vrms. Dimensions from approx. 19 x 24 to 19x35 mm board space and 30 mm height.

## Other Relays

We offer a variety of different relay families for maintenance and replacement purposes. These relays are up to 60 years old now, such as Card Relay SN (V23030 / V23031 series), Small General Purpose Relay (V23006 series), Small Polarized Relay (V23063 ... V23067 and V23163 ... V23167 series). Accessories like sockets, hold down springs, etc. optional.

## HF3 Relay

High performance low cost RF relay with excellent RF characteristics. Available with an impedance of 50 and 75 Ohm. Suitable for frequencies up to 3 GHz. Actually smallest RF relay available combining small size, excellent RF performance and SMD solderability. Available as non latching or latching relay with 1 or 2 coils and a nominal coil voltage range from 3 ... 24 V, coil power consumption 140 mW, latching relays with 1 coil 70 mW. Dimensions 14,6 x 7,3 x 10 mm.



Tyco Electronics AXICOM Ltd.  
Seestrasse 295 - P.O. Box 220  
CH-8804 Au-Wädenswil / Switzerland  
Phone +41 1 782 9111  
Fax +41 1 782 9080  
E-mail: [axicom@tycoelectronics.com](mailto:axicom@tycoelectronics.com)



Tyco Electronics  
Paulsternstrasse 26  
D-13629 Berlin / Germany  
Phone +49 30 386 38573  
Fax +49 30 386 38575  
E-mail: [axicom@tycoelectronics.com](mailto:axicom@tycoelectronics.com)



Tyco Electronics EC Trutnov s.r.o.  
Komenského 821  
CZ-541 01 Trutnov / Czech Republic  
E-mail: [axicom@tycoelectronics.com](mailto:axicom@tycoelectronics.com)

Tyco Electronics Corporation  
POB 3608,  
Harrisburg, PA 17105, USA  
Phone +001 800-522-6752