

TOSHIBA Photo-IC Si Monolithic Photo-IC

TPS830(F)

Unit : mm

High-Speed Optical Remote Controllers
 Wireless Mouse, Wireless keyboard
 IR Data Communications

- Photodiode, I-V converter, band-pass filter and AGC amplifier all incorporated in a single chip
- Carrier frequency: $f_o = 455\text{kHz}$ (typ.)
- Supply voltage: $V_{CC} = 5\text{V}$
- Visible light cut-off frequency: $\lambda > 700\text{nm}$
- TLN105B(F) and TLN231(F) available as infrared LEDs for remote controllers

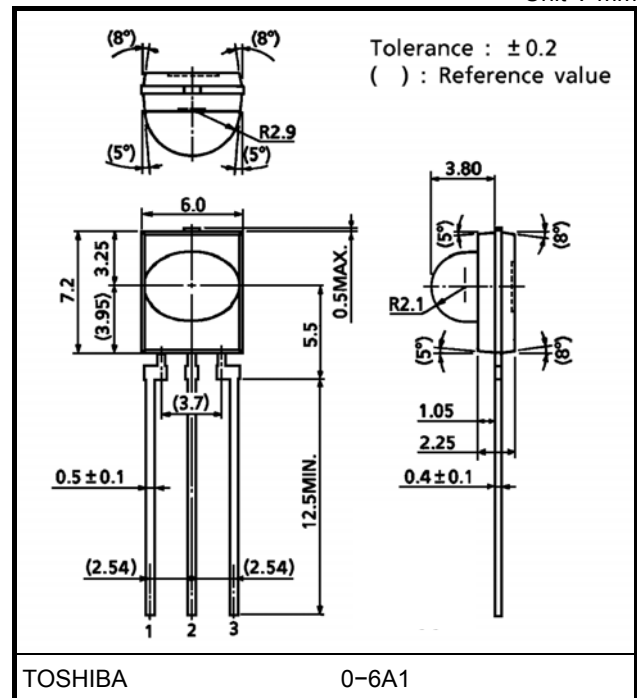

Weight: 0.3 g (typ.)

Absolute Maximum Ratings (Ta = 25°C)

Characteristic	Symbol	Rating	Unit
Supply voltage	V_{CC}	7	V
Output current	I_O	± 10	μA
Operating temperature range	T_{opr}	-20~60	°C
Storage temperature range	T_{stg}	-30~100	°C
Soldering temperature range (5 s)	T_{sol}	260	°C

Note: Using continuously under heavy loads (e.g. the application of high temperature/current/voltage and the significant change in temperature, etc.) may cause this product to decrease in the reliability significantly even if the operating conditions (i.e. operating temperature/current/voltage, etc.) are within the absolute maximum ratings and the operating ranges.

Please design the appropriate reliability upon reviewing the Toshiba Semiconductor Reliability Handbook ("Handling Precautions"/"Derating Concept and Methods") and individual reliability data (i.e. reliability test report and estimated failure rate, etc).

Optical And Electrical Characteristics (V_{CC} = 5V, Ta = 25°C, C = 1000pF: Note 1)

Characteristic	Symbol	Test Condition	Min	Typ.	Max	Unit
Supply voltage	V _{CC}	—	3	5	7	V
Supply current	I _{CC}	E = 0	—	1.2	3	mA
Electromagnetic sensitivity	E _S	(Note 5)	—	250	—	V _{p-p} / m
Transmission range	L (Note 3)	The burst wave shown in Note 4 is transmitted by a standard transmitter (Note 2).	3	6	—	m
High-level output voltage	V _{OH}		4	—	—	V
Low-level output voltage	V _{OL}		—	—	0.5	V
On pulse width	T _{ON}	External light intensity < 500 lx	16	25	40	μs
Off pulse width	T _{OFF}	Output current < 10μA	—	63	—	μs
Carrier frequency	f _o	—	—	455	—	kHz
Peak sensitivity wavelength	λ _P	—	—	900	—	nm
Radiation angle	θ _H	Horizontal angle, L / 2 (Note 6)	±55	±63	—	°
	θ _V	Vertical angle, L / 2 (Note 6)	±25	±30	—	°

Note 1: Measurements for the TPS830(F) are based on a standard circuit which includes a 1000-pF capacitor between VO and GND to prevent oscillation.

Note 2: Standard transmitter

In the figure above, the transmitter output V_{OUT} is 80m V_{pp}.
 The TPS703(F) in this application has a short-circuit current of I_{sc} = 1.24μA when measured at E = 0.1mW/cm². (E is the radiant incidence when a CIE standard light source A is used.)

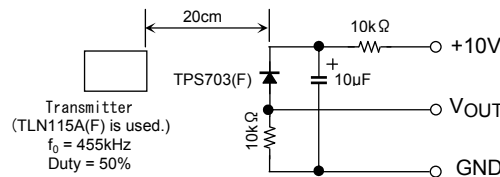

Note 3: Transmission range L
 Standard transmitter (TLN105B(F))

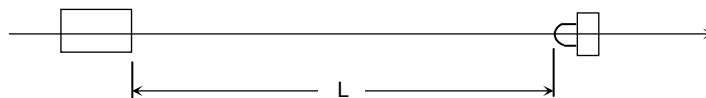

L is the maximum distance at which burst waves can be received from the transmitter unit, and at which data can be processed by the receiver unit.

Note that when signals other than the recommended burst wave are transmitted, the transmission range may be reduced or a malfunction may occur.

(*) The TLN105B(F) is used as the standard LED transmitter.

If the TLN231(F) is used instead, the transmission range is 1.2 times that of the TLN105B(F).

Example: 6m (with TLN105B(F)) ⇒ 10.1m (with TLN231(F))

Note 4: Burst wave

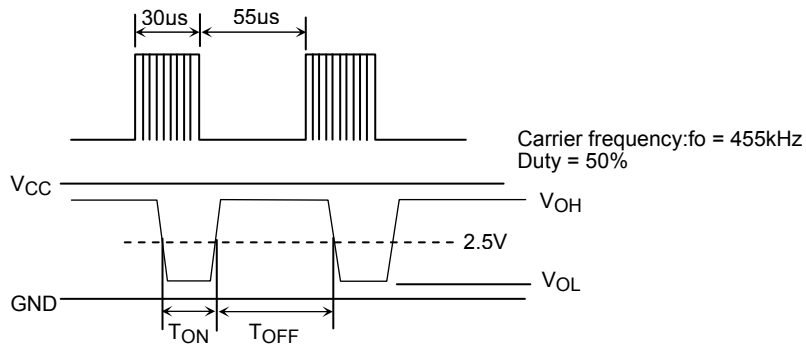

Note 5: Electromagnetic sensitivity

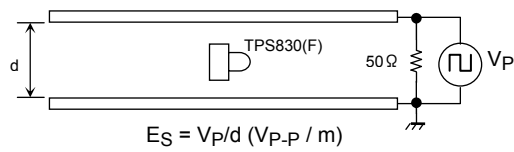

Mount the device between two parallel boards separated by a distance of d .
 Apply voltages modulated using frequencies ranging from 10kHz to 50MHz across the boards and read off the voltage at which noise is generated in the output from the device.
 (*) Usage in strong electromagnetic fields may affect the device.
 Please evaluate product in this type of environment before releasing them for actual use.

Note 6: Radiation angle

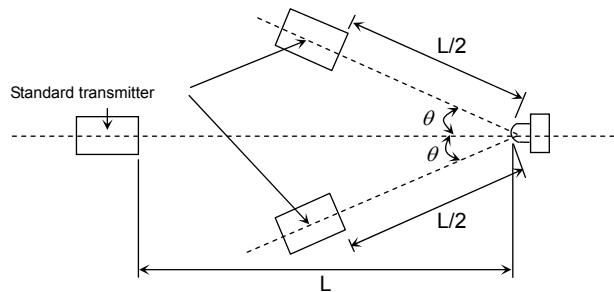

Circuit Block Diagram

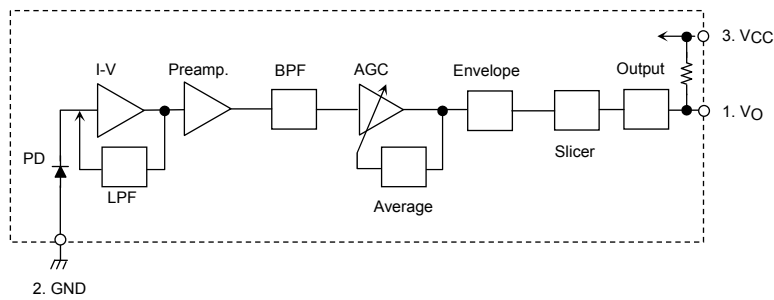

Bit Pattern Designing Example (reference)

- Example of code signal = 11010010

Sequence of LED signals = 1 must be avoided. If LED signals of 1 sequence, TPS830(F) may not receive LED signals properly. After an LED signal of 1, 0 must be sent (55μ or longer interval necessary).

Please take this into account when designing a bit pattern.

The following shows the bit pattern t example that is converted at first code signals to LED signals as shown on the right diagram.

<Conversion example>	
Code signal	LED signal
0	→ 00
1	→ 10

<Pattern example>

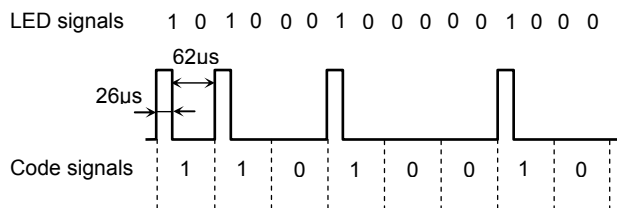

Precautions

1. To stabilize the power line, insert a bypass capacitor of up to 0.01μF between VCC and GND, close to the device.
2. At power-on the internal circuit takes about 100μs to stabilize. During this period the output signal is unstable and may change.
3. To avoid unnecessary oscillation, insert a bypass capacitor of 1000pF between VCC and GND.
4. When using the device, please take the device's characteristics, the operating environment and the characteristics of pairing LED device into considerations.
5. Soldering temperature: ≤ 260°C, soldering time : ≤ 5s (Soldering must be performed under the 2mm from the body of the device.)
6. When forming the leads, bend each lead under the 2mm from the body of the device. Soldering must be performed after the leads have been formed.

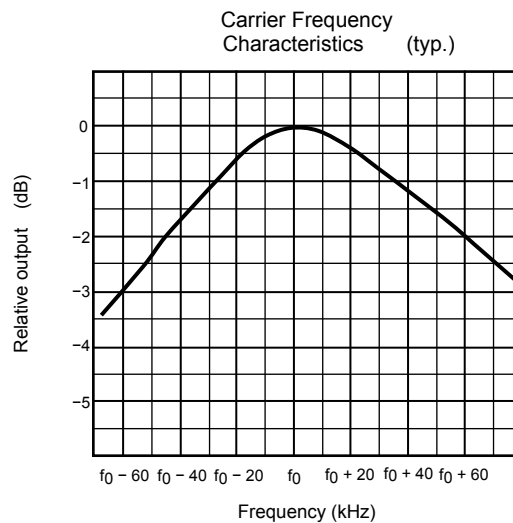
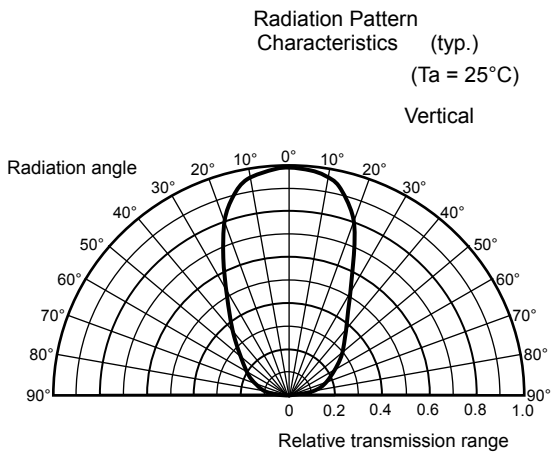
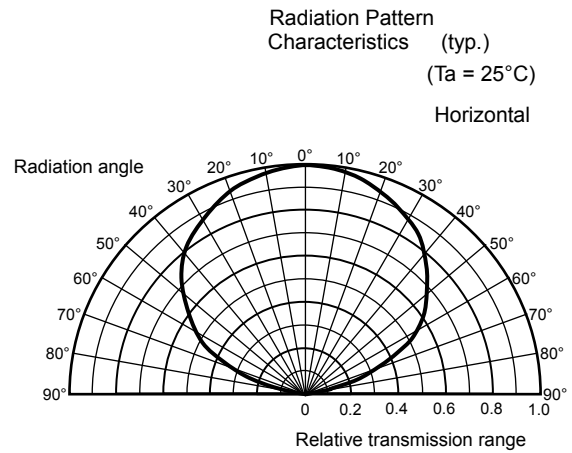
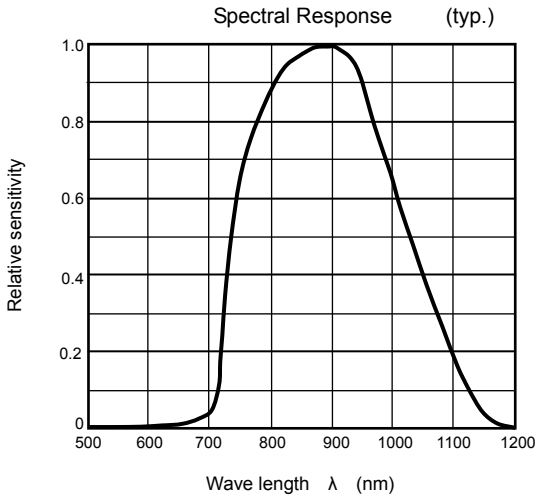
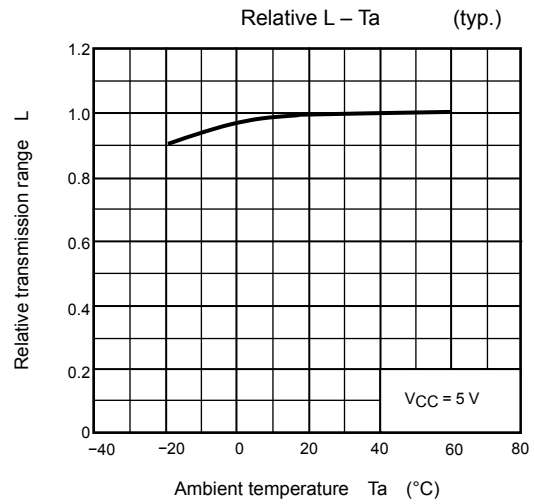
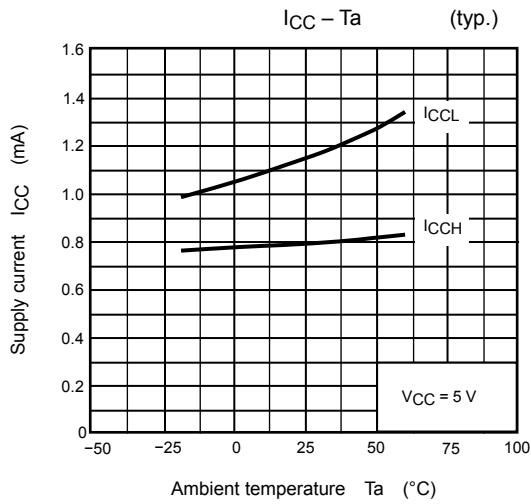

RESTRICTIONS ON PRODUCT USE

- Toshiba Corporation, and its subsidiaries and affiliates (collectively "TOSHIBA"), reserve the right to make changes to the information in this document, and related hardware, software and systems (collectively "Product") without notice.
- This document and any information herein may not be reproduced without prior written permission from TOSHIBA. Even with TOSHIBA's written permission, reproduction is permissible only if reproduction is without alteration/omission.
- Though TOSHIBA works continually to improve Product's quality and reliability, Product can malfunction or fail. Customers are responsible for complying with safety standards and for providing adequate designs and safeguards for their hardware, software and systems which minimize risk and avoid situations in which a malfunction or failure of Product could cause loss of human life, bodily injury or damage to property, including data loss or corruption. Before creating and producing designs and using, customers must also refer to and comply with (a) the latest versions of all relevant TOSHIBA information, including without limitation, this document, the specifications, the data sheets and application notes for Product and the precautions and conditions set forth in the "TOSHIBA Semiconductor Reliability Handbook" and (b) the instructions for the application that Product will be used with or for. Customers are solely responsible for all aspects of their own product design or applications, including but not limited to (a) determining the appropriateness of the use of this Product in such design or applications; (b) evaluating and determining the applicability of any information contained in this document, or in charts, diagrams, programs, algorithms, sample application circuits, or any other referenced documents; and (c) validating all operating parameters for such designs and applications. **TOSHIBA ASSUMES NO LIABILITY FOR CUSTOMERS' PRODUCT DESIGN OR APPLICATIONS.**
- Product is intended for use in general electronics applications (e.g., computers, personal equipment, office equipment, measuring equipment, industrial robots and home electronics appliances) or for specific applications as expressly stated in this document. Product is neither intended nor warranted for use in equipment or systems that require extraordinarily high levels of quality and/or reliability and/or a malfunction or failure of which may cause loss of human life, bodily injury, serious property damage or serious public impact ("Unintended Use"). Unintended Use includes, without limitation, equipment used in nuclear facilities, equipment used in the aerospace industry, medical equipment, equipment used for automobiles, trains, ships and other transportation, traffic signaling equipment, equipment used to control combustions or explosions, safety devices, elevators and escalators, devices related to electric power, and equipment used in finance-related fields. Do not use Product for Unintended Use unless specifically permitted in this document.
- Do not disassemble, analyze, reverse-engineer, alter, modify, translate or copy Product, whether in whole or in part.
- Product shall not be used for or incorporated into any products or systems whose manufacture, use, or sale is prohibited under any applicable laws or regulations.
- The information contained herein is presented only as guidance for Product use. No responsibility is assumed by TOSHIBA for any infringement of patents or any other intellectual property rights of third parties that may result from the use of Product. No license to any intellectual property right is granted by this document, whether express or implied, by estoppel or otherwise.
- **ABSENT A WRITTEN SIGNED AGREEMENT, EXCEPT AS PROVIDED IN THE RELEVANT TERMS AND CONDITIONS OF SALE FOR PRODUCT, AND TO THE MAXIMUM EXTENT ALLOWABLE BY LAW, TOSHIBA (1) ASSUMES NO LIABILITY WHATSOEVER, INCLUDING WITHOUT LIMITATION, INDIRECT, CONSEQUENTIAL, SPECIAL, OR INCIDENTAL DAMAGES OR LOSS, INCLUDING WITHOUT LIMITATION, LOSS OF PROFITS, LOSS OF OPPORTUNITIES, BUSINESS INTERRUPTION AND LOSS OF DATA, AND (2) DISCLAIMS ANY AND ALL EXPRESS OR IMPLIED WARRANTIES AND CONDITIONS RELATED TO SALE, USE OF PRODUCT, OR INFORMATION, INCLUDING WARRANTIES OR CONDITIONS OF MERCHANTABILITY, FITNESS FOR A PARTICULAR PURPOSE, ACCURACY OF INFORMATION, OR NONINFRINGEMENT.**
- Do not use or otherwise make available Product or related software or technology for any military purposes, including without limitation, for the design, development, use, stockpiling or manufacturing of nuclear, chemical, or biological weapons or missile technology products (mass destruction weapons). Product and related software and technology may be controlled under the Japanese Foreign Exchange and Foreign Trade Law and the U.S. Export Administration Regulations. Export and re-export of Product or related software or technology are strictly prohibited except in compliance with all applicable export laws and regulations.
- Please contact your TOSHIBA sales representative for details as to environmental matters such as the RoHS compatibility of Product. Please use Product in compliance with all applicable laws and regulations that regulate the inclusion or use of controlled substances, including without limitation, the EU RoHS Directive. TOSHIBA assumes no liability for damages or losses occurring as a result of noncompliance with applicable laws and regulations.