

TOSHIBA PHOTO-IC Si MONOLITHIC PHOTO-IC

TPS831

HIGH-SPEED OPTICAL REMOTE CONTROLLERS
 CORDLESS CONTROLLERS FOR VIDEOGAMES
 ELECTRONIC ORGANIZERS AND OTHER NEW
 PORTABLE INFORMATION DEVICES
 IR DATA COMMUNICATIONS

- Photodiode, I-V converter, band-pass filter and AGC amplifier all incorporated in a single chip
- Carrier frequency : $f_0 = 455 \text{ kHz}$ (typ.)
- Supply voltage : $V_{CC} = 5 \text{ V}$
- Visible light cut-off frequency : 800 nm
- TLN105B and TLN115A available as infrared LEDs for remote controllers

Unit : mm

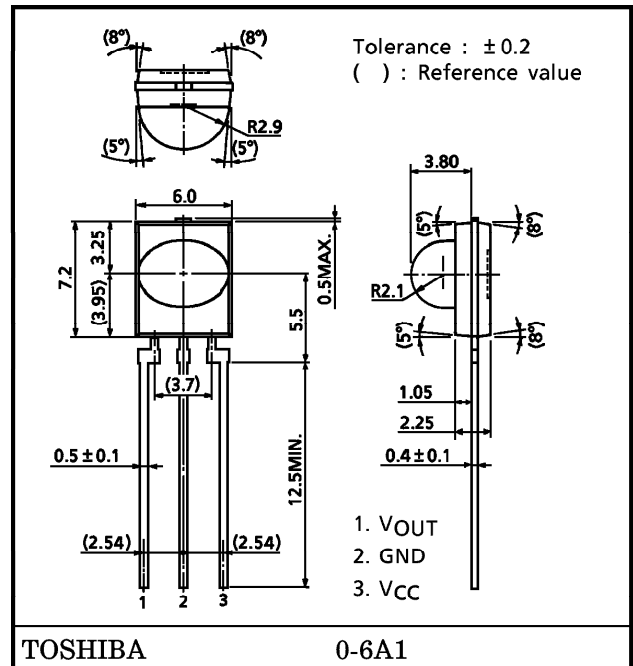

Weight : 0.3 g (typ.)

MAXIMUM RATINGS ($T_a = 25^\circ\text{C}$)

CHARACTERISTIC	SYMBOL	RATING	UNIT
Supply Voltage	V_{CC}	7	V
Operating Temperature Range	T_{opr}	-20~60	°C
Storage Temperature Range	T_{stg}	-30~100	°C
Soldering Temperature Range (5s)	T_{sol}	260	°C

OPTICAL AND ELECTRICAL CHARACTERISTICS ($V_{CC} = 5\text{ V}$, $T_a = 25^\circ\text{C}$, $C = 1000\text{ pF}$: Note 1)

CHARACTERISTIC	SYMBOL	TEST CONDITION	Min	Typ.	Max	UNIT
Supply Voltage	V_{CC}	—	3	5	7	V
Supply Current	I_{CC}	$E = 0$	—	1.2	3.0	mA
Electromagnetic Sensitivity	E_S	(Note 5)	—	250	—	V_{p-p}/m
Transmission Range	L (Note 3)	The burst wave shown in Note 4 is transmitted by a standard transmitter (Note 2).	3	5	—	m
High-Level Output Voltage	V_{OH}		4.0	—	—	V
Low-Level Output Voltage	V_{OL}		—	—	0.5	V
ON Pulse Width	T_{ON}	External light intensity $< 500\text{ lx}$ Output Current $< 10\text{ }\mu\text{A}$	16	25	40	μs
OFF Pulse Width	T_{OFF}		—	63	—	μs
Carrier Frequency	f_o	—	—	455	—	kHz
Radiation Angle	θ_H	Horizontal angle, $L/2$ (Note 6)	± 55	± 63	—	$^\circ$
	θ_V	Vertical angle, $L/2$ (Note 6)	± 25	± 30	—	$^\circ$

(Note 1) : Measurements for the TPS831 are based on a standard circuit which includes a 1000-pF capacitor between V_O and GND to prevent oscillation.

(Note 2) : Standard transmitter

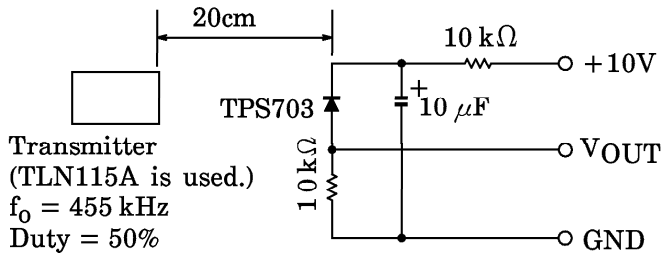

In the figure above, the transmitter output V_{OUT} is 80 mVpp. The TPS703 in this application has a short-circuit current of $I_{SC} = 1.24\text{ }\mu\text{A}$ when measured at $E = 0.1\text{ mW}/\text{cm}^2$. (E is the radiant incidence when a CIE standard light source A is used.)

(Note 3) : Transmission range L

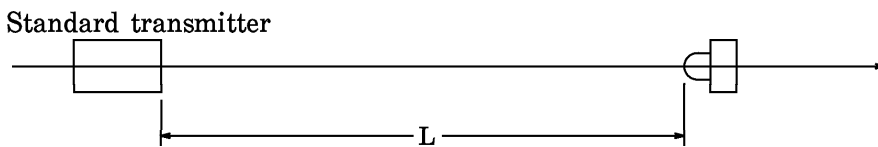

(Note 4) Burst wave

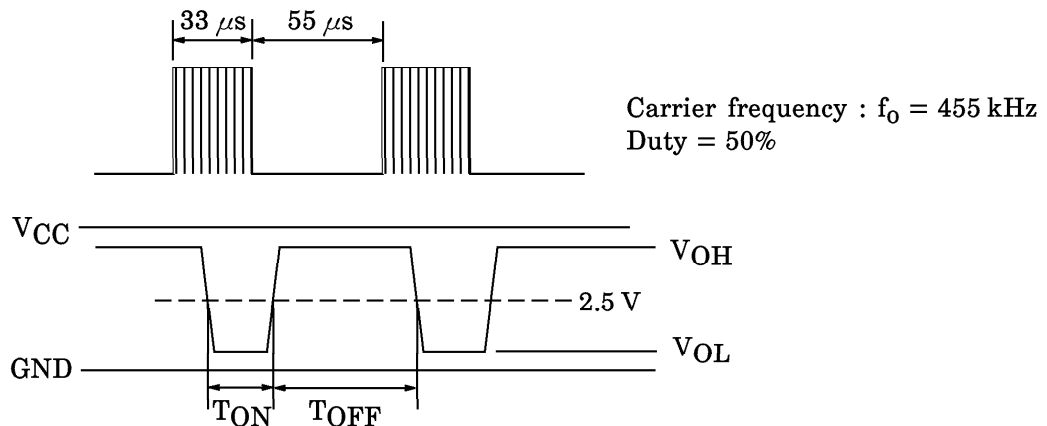

(Note 5) : Electromagnetic sensitivity

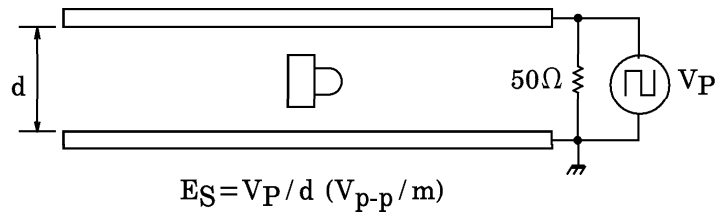

(Note 6) : Radiation angle

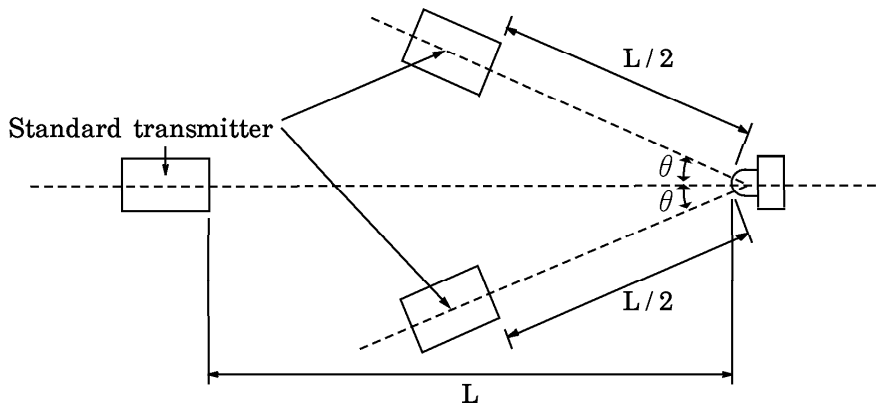

Circuit block diagram

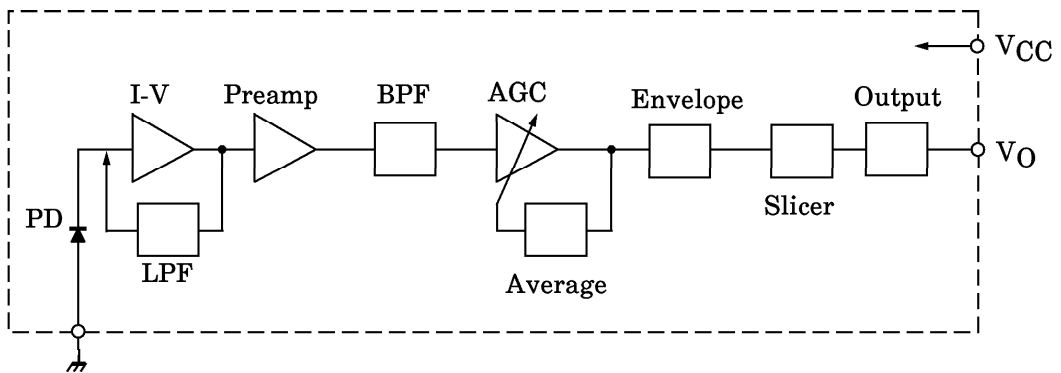

Bit pattern designing example (reference)

- Example of code signal = 11010010

Sequence of LED signals = 1 must be avoided. If LED signals of 1 sequence, TPS830 may not receive LED signals properly. After an LED signal of 1, 0 must be sent (55 μ s or longer interval necessary). Please take this into account when designing a bit pattern.

The following shows the bit pattern t example that is converted at first code signals to LED signals as shown on the right diagram.

< Conversion example >	
Code signal	LED signal
0	→ 00
1	→ 10

<Pattern example>

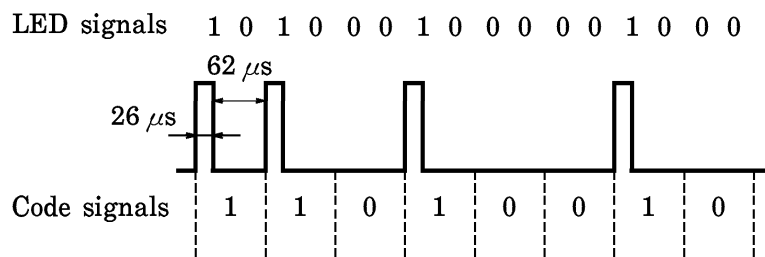

PRECAUTIONS

1. To stabilize the power line, insert a bypass capacitor of up to 0.01 μ F between V_{CC} and GND, close to the device.
2. At power-on the internal circuit takes about 100 μ s to stabilize. During this period the output signal is unstable and may change.
3. To avoid unnecessary oscillation, insert a bypass capacitor of 1000 pF between V_{CC} and GND.
4. When using the device, please take the device's characteristics, the operating environment and the characteristics of pairing LED device into considerations.
5. Soldering temperature : $\leq 260^{\circ}\text{C}$, Soldering time : ≤ 5 s (Soldering must be performed under the 2 mm from the body of the device.)
6. When forming the leads, bend each lead under the 2 mm from the body of the device. Soldering must be performed after the leads have been formed.

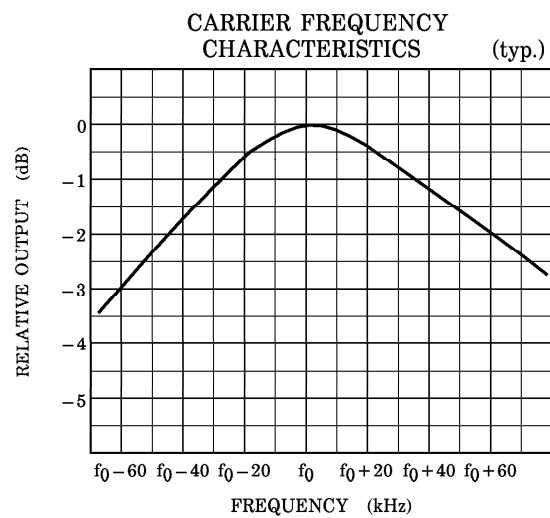
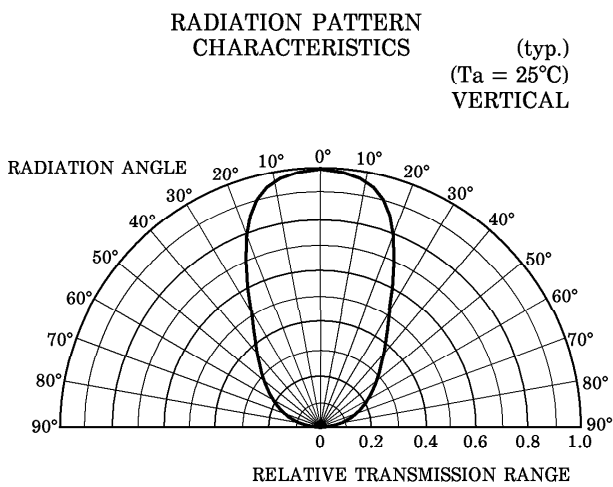
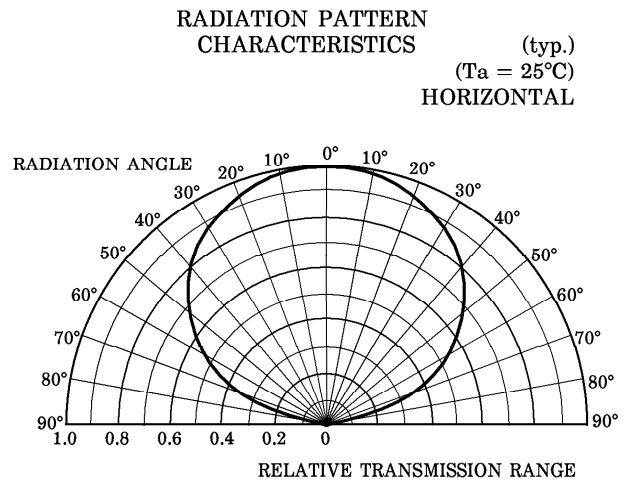
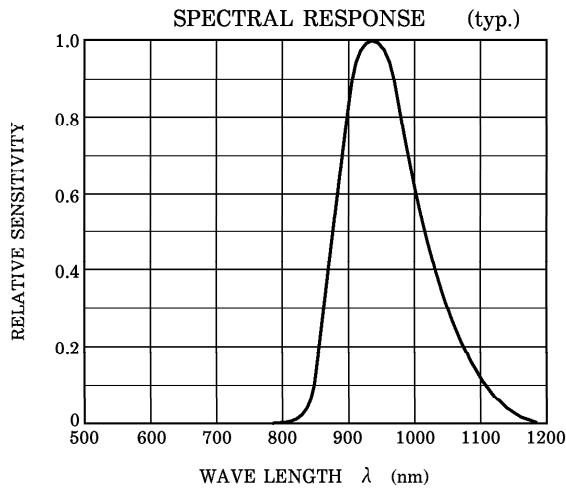
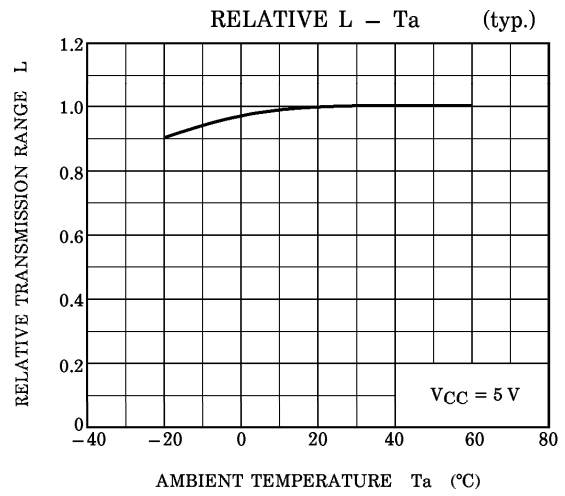
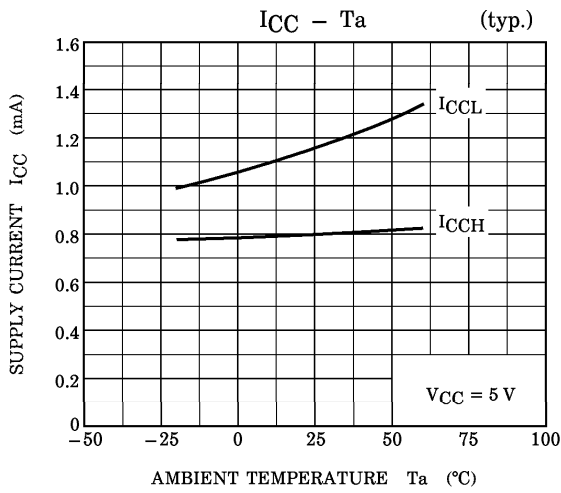

RESTRICTIONS ON PRODUCT USE

000707EBA

- TOSHIBA is continually working to improve the quality and reliability of its products. Nevertheless, semiconductor devices in general can malfunction or fail due to their inherent electrical sensitivity and vulnerability to physical stress. It is the responsibility of the buyer, when utilizing TOSHIBA products, to comply with the standards of safety in making a safe design for the entire system, and to avoid situations in which a malfunction or failure of such TOSHIBA products could cause loss of human life, bodily injury or damage to property. In developing your designs, please ensure that TOSHIBA products are used within specified operating ranges as set forth in the most recent TOSHIBA products specifications. Also, please keep in mind the precautions and conditions set forth in the "Handling Guide for Semiconductor Devices," or "TOSHIBA Semiconductor Reliability Handbook" etc..
- The TOSHIBA products listed in this document are intended for usage in general electronics applications (computer, personal equipment, office equipment, measuring equipment, industrial robotics, domestic appliances, etc.). These TOSHIBA products are neither intended nor warranted for usage in equipment that requires extraordinarily high quality and/or reliability or a malfunction or failure of which may cause loss of human life or bodily injury ("Unintended Usage"). Unintended Usage include atomic energy control instruments, airplane or spaceship instruments, transportation instruments, traffic signal instruments, combustion control instruments, medical instruments, all types of safety devices, etc.. Unintended Usage of TOSHIBA products listed in this document shall be made at the customer's own risk.
- The products described in this document are subject to the foreign exchange and foreign trade laws.
- The information contained herein is presented only as a guide for the applications of our products. No responsibility is assumed by TOSHIBA CORPORATION for any infringements of intellectual property or other rights of the third parties which may result from its use. No license is granted by implication or otherwise under any intellectual property or other rights of TOSHIBA CORPORATION or others.
- The information contained herein is subject to change without notice.