

SPECIFICATION

- Part No. : **GW.05.0153**
- Product Name : Dual-Band WiFi 2.4~2.5GHz/5.15~5.85GHz
Terminal Mount Monopole Antenna
- Features : High Efficiency – with and without groundplane
WiFi/Bluetooth/Zigbee
Extremely Compact - 62.3mm ± 1.5mm
Aesthetic look and feel
Unique can rotate 360 degrees and articulate
through 180 degrees
Max Peak Gain compliant with most WiFi modules
Standard RP-SMA(M) connector
ROHS Compliant

Photo:



1. Introduction

The GW.05 dual band WiFi Hinged Rotatable Antenna is a high efficiency monopole antenna. Compared to other much larger antennas on the market, it has superior wide-band high efficiency characteristics. The bright green colour of the antenna adds a unique quality look and feel to any modern WiFi application point, device or router. It also provides differentiation if using Taoglas other similar looking antennas (such as the black color Taoglas TG.09 cellular antenna) on same device. The connector used is Rev SMA(M), the standard mating part for an antenna to most WiFi application points and routers in the market.

The GW.05, as all monopole antennas, works best connected directly to the ground-plane of the device main PCB or to the outside of a metal housing. However it still has very good performance (>50%) even without connecting to a ground-plane, making it the best all round small WiFi terminal antenna on the market.

In the un-grounded installation condition it also comes below the max peak gain requirements for most WiFi modules which are usually 2dBi, so it can comply with FCC regulations.

The GW.05 is for Wi-Fi, WLAN, Zigbee, Bluetooth, and 802.11a/b/g/n/ac applications.

Many module manufacturers specify peak gain limits for any antennas that are to be connected to that module. Those peak gain limits are based on free-space conditions. In practice, the peak gain of an antenna tested in free-space can degrade by at least 1 or 2dBi when put inside a device. So ideally you should go for a slightly higher peak gain antenna than mentioned on the module specification to compensate for this effect, giving you better performance.

Upon testing of any of our antennas with your device and a selection of appropriate layout, integration technique, or cable, Taoglas can make sure any of our antennas' peak gain will be below the peak gain limits. Taoglas can then issue a specification and/or report for the selected antenna in your device that will clearly show it complying with the peak gain limits, so you can be assured you are meeting regulatory requirements for that module.

For example, a module manufacturer may state that the antenna must have less than 2dBi peak gain, but you don't need to select an embedded antenna that has a peak gain of less than 2dBi in free-space. This will give you a less optimized solution. It is better to go for a slightly higher free-space peak gain of 3dBi or more if available. Once that antenna gets integrated into your device, performance will degrade below this 2dBi peak gain due to the effects of GND plane, surrounding components, and device housing. If you want to be absolutely sure, contact Taoglas and we will test. Choosing a Taoglas antenna with a higher peak gain than what is specified by the module manufacturer and enlisting our help will ensure you are getting the best performance possible without exceeding the peak gain limits.

It is better not to select an embedded antenna with very low free-space peak gain (<2dBi) directly, as this antenna would have worse performance in your device, and lead to compromised performance compared to using a Taoglas antenna.

Also comes as a standard SMA(M) version.

2. Specification

Parameter		Wireless Bands						
Straight Position								
Frequency (MHz)		2400	2450	2500	5150	5350	5750	5850
Average Gain (dBi)	In Free Space	-2.62	-2.61	-1.74	-2.00	-2.17	-3.15	-2.62
Efficiency (%)		54.71	54.78	67.05	63.12	60.71	48.43	54.71
Peak Gain (dBi)		1.04	1.25	0.82	0.85	1.38	0.28	1.04
Return Loss (dB)		< -6			< -10			
Average Gain (dBi)	With 15x9cm Ground Plane	-1.90	-1.58	-2.28	-2.98	-3.08	-4.06	-1.90
Efficiency (%)		64.54	69.56	59.14	50.33	49.21	39.26	64.54
Peak Gain (dBi)		3.22	3.57	1.42	1.07	1.30	0.40	3.22
Return Loss (dB)		< -8			< -5			
Average Gain (dBi)	On 30x30cm Metal Plane Edge	-0.88	-0.62	-1.37	-1.62	-1.97	-2.74	-0.88
Efficiency (%)		81.67	86.74	72.99	68.85	63.56	53.23	81.67
Peak Gain (dBi)		4.73	5.13	3.83	3.63	3.93	3.21	4.73
Return Loss (dB)		< -10			< -10			
Average Gain (dBi)	On 30x30cm	-1.67	-1.12	-2.36	-2.57	-2.32	-3.18	-1.67

Efficiency (%)	Metal Plane Center	68.05	77.21	58.10	55.32	58.60	48.11	68.05
Peak Gain (dBi)		3.85	4.62	4.50	4.21	5.80	4.67	3.85
Return Loss (dB)		< -6			< -10			
Bent Position 90°								
Average Gain (dBi)	In Free Space	-2.80	-2.71	-1.67	-1.71	-1.68	-1.85	-2.80
Efficiency (%)		52.53	53.54	68.07	67.43	67.87	65.29	52.53
Peak Gain (dBi)		1.19	1.57	2.57	0.66	1.03	0.59	1.19
Return Loss (dB)		< -6			< -10			
Average Gain (dBi)	With 15x9cm Ground Plane	-1.80	-1.50	-1.98	-2.18	-2.18	-2.42	-1.80
Efficiency (%)		66.14	70.72	63.44	60.53	60.57	57.34	66.14
Peak Gain (dBi)		3.47	3.68	3.88	3.59	2.40	1.92	3.47
Return Loss (dB)		< -8			< -7			
Average Gain (dBi)	On 30x30cm Metal Plane Edge	-0.89	-0.63	-1.52	-1.63	-1.30	-1.36	-0.89
Efficiency (%)		81.40	86.57	70.51	68.75	74.21	73.15	81.40
Peak Gain (dBi)		5.36	5.46	4.98	4.33	4.07	4.53	5.36
Return Loss (dB)		< -10			< -10			
Average Gain (dBi)	On 30x30cm Metal Plane Center	-1.53	-0.97	-2.10	-2.28	-1.95	-2.38	-1.53
Efficiency (%)		70.29	80.04	61.72	59.21	63.83	57.80	70.29
Peak Gain (dBi)		3.63	4.36	3.81	3.31	4.90	4.04	3.63
Return Loss (dB)		< -7			< -10			
Radiation		Omni-directional						
Polarization		Linear						
Impedance		50 Ω						
Input Power		10W						
MECHANICAL								
Antenna length		62.3mm						
Antenna Diameter		10mm						
Casing		POM						
Connector		RP-SMA(M)						
Weight		6g						
Recommended Torque for Mounting		0.9N·m						
Max Torque for Mounting		1.176N·m						
ENVIRONMENTAL								
Operation Temperature		-40°C ~ + 85°C						
Storage Temperature		-40°C ~ + 85°C						

Humidity

Non-condensing 65°C 95% RH

3. Antenna Characteristics

3.1 Testing Setup

Antenna Straight Position



a) In free space

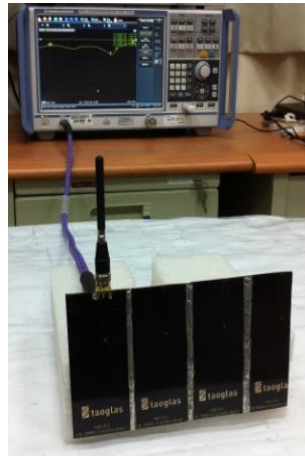

b) with 15*9cm
Ground Plane



c) with 30*30cm
Ground Plane Edge



d) with 30*30cm
Ground Plane Center

Antenna Bent 90° Position



a) In free space

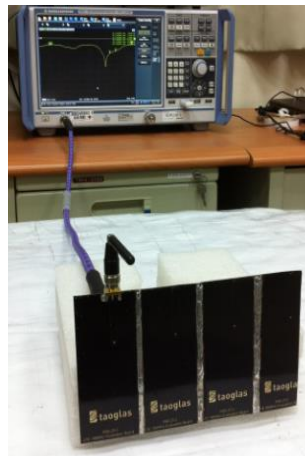

b) with 15*9cm
Ground Plane



c) with 30*30cm
Ground Plane Edge



d) with 30*30cm
Ground Plane Center

Figure.1 Measurement environments

3.2 Return Loss

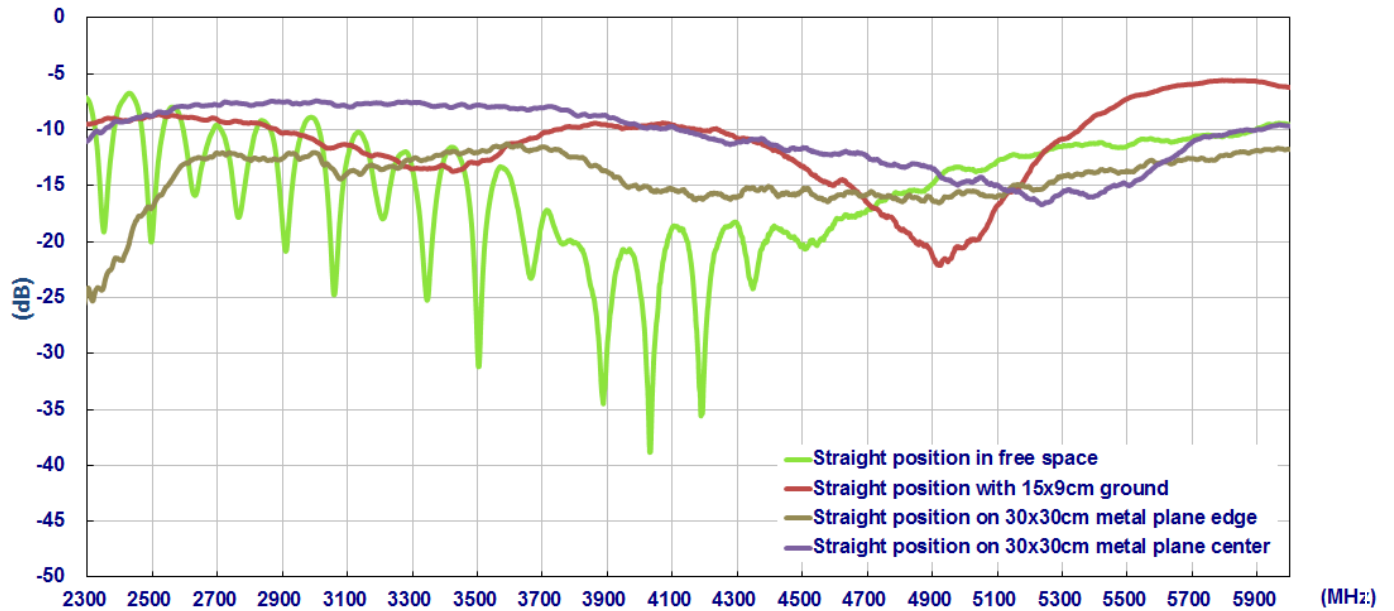

Figure2. Return loss of GW.05 antenna with straight position

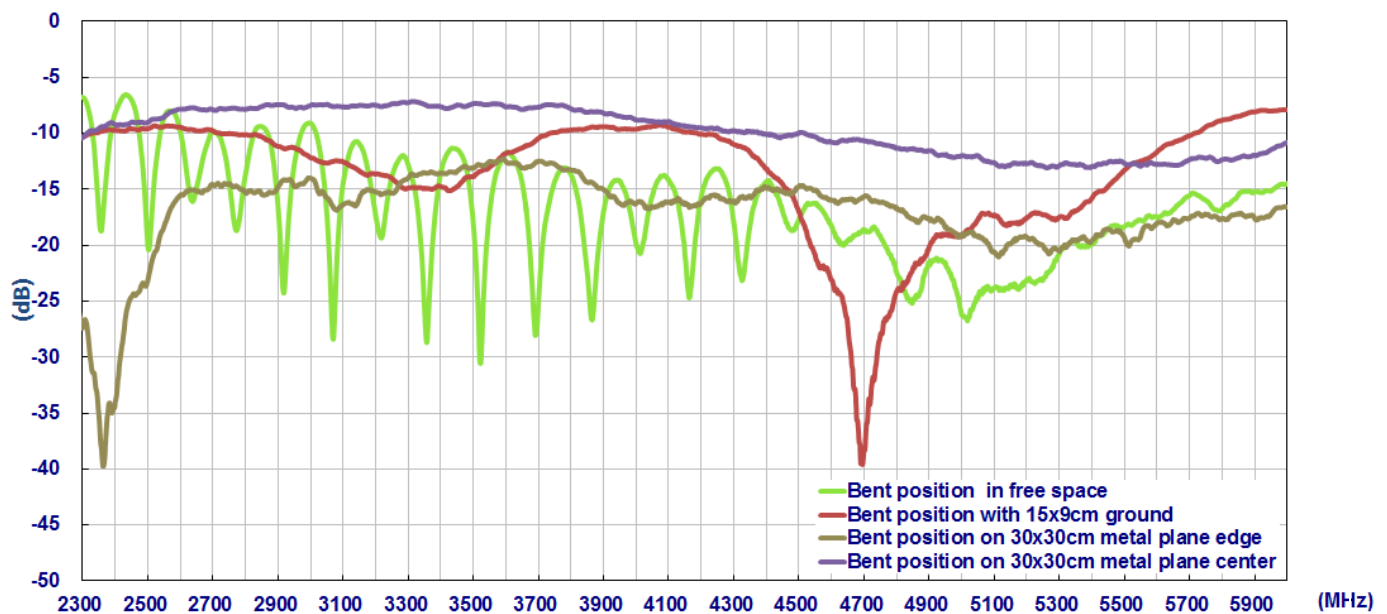

Figure3. Return loss of GW.05 antenna with bent position

3.3 Efficiency

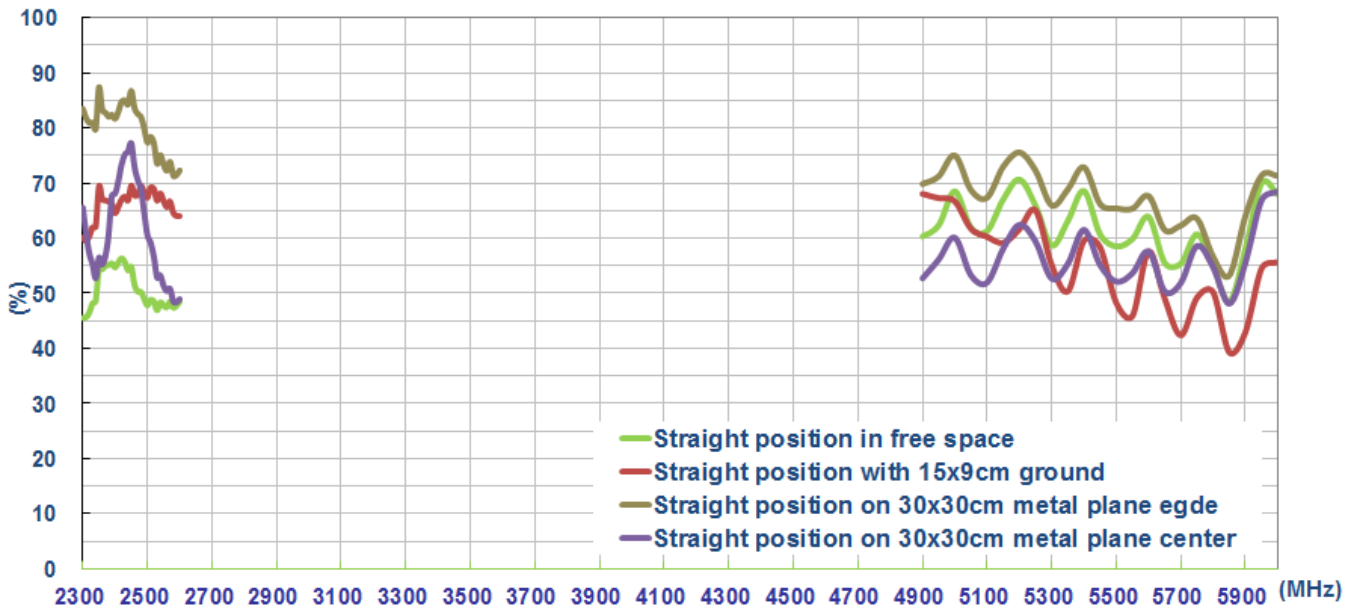

Figure4. Efficiency of GW.05 antenna with straight position

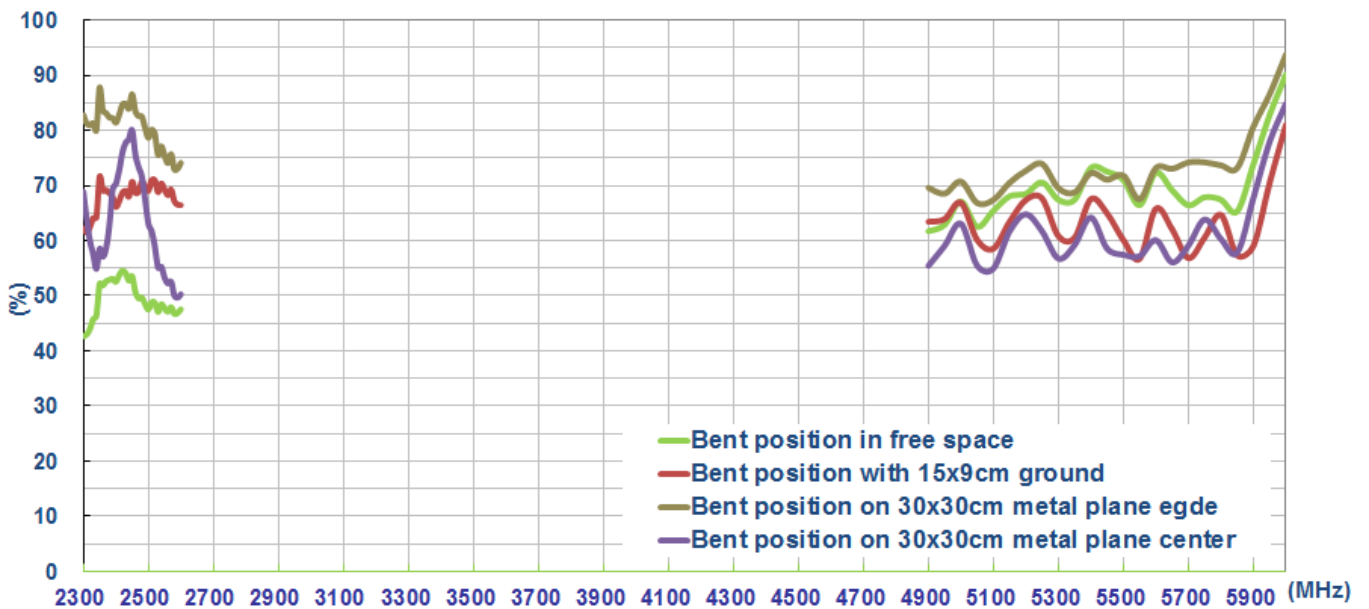

Figure5. Efficiency of GW.05 antenna with bent position

3.4 Peak Gain

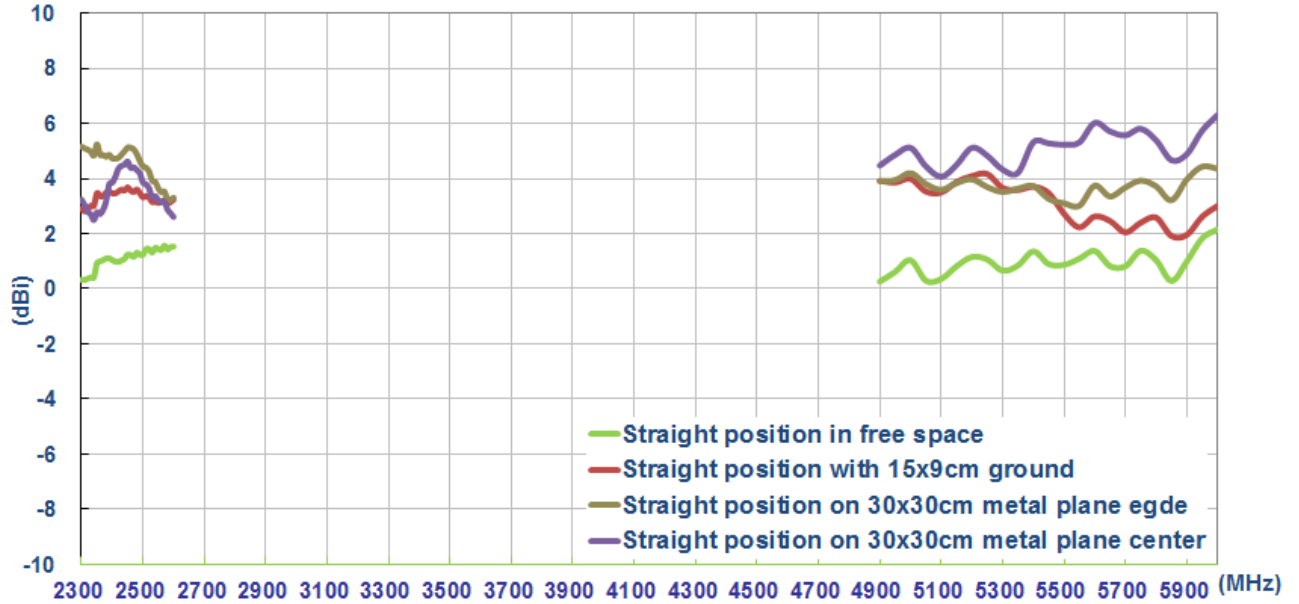

Figure6. Peak gain of GW.05 antenna with straight position

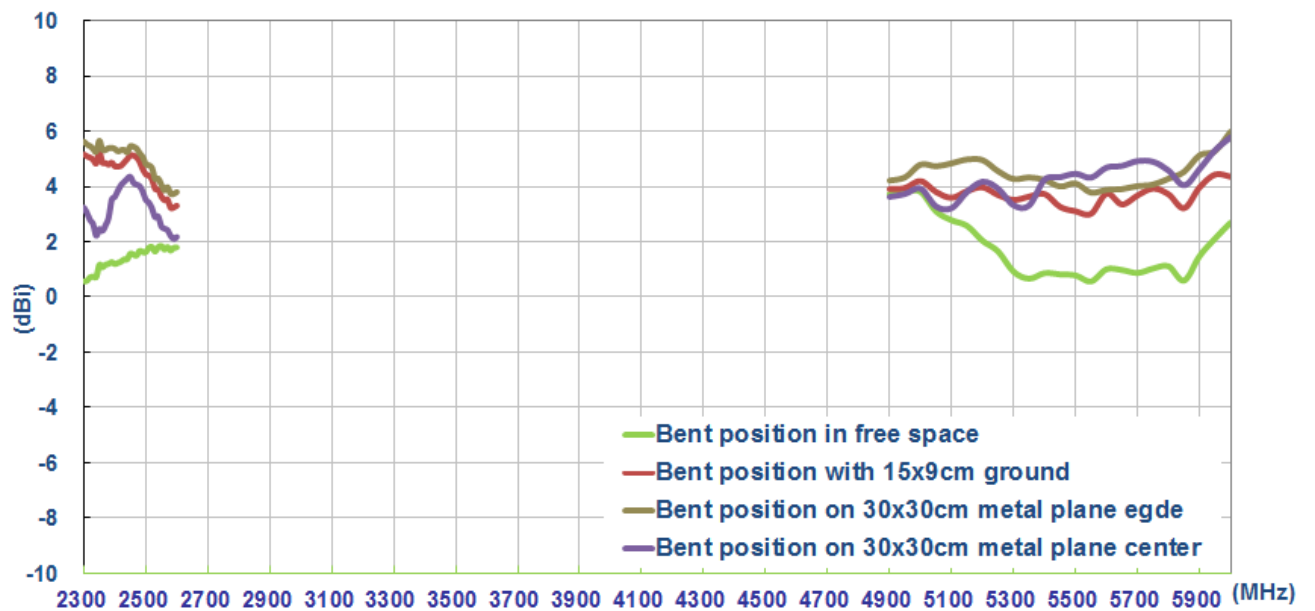

Figure7. Peak gain of GW.05 antenna with bent position

3.5 Average Gain

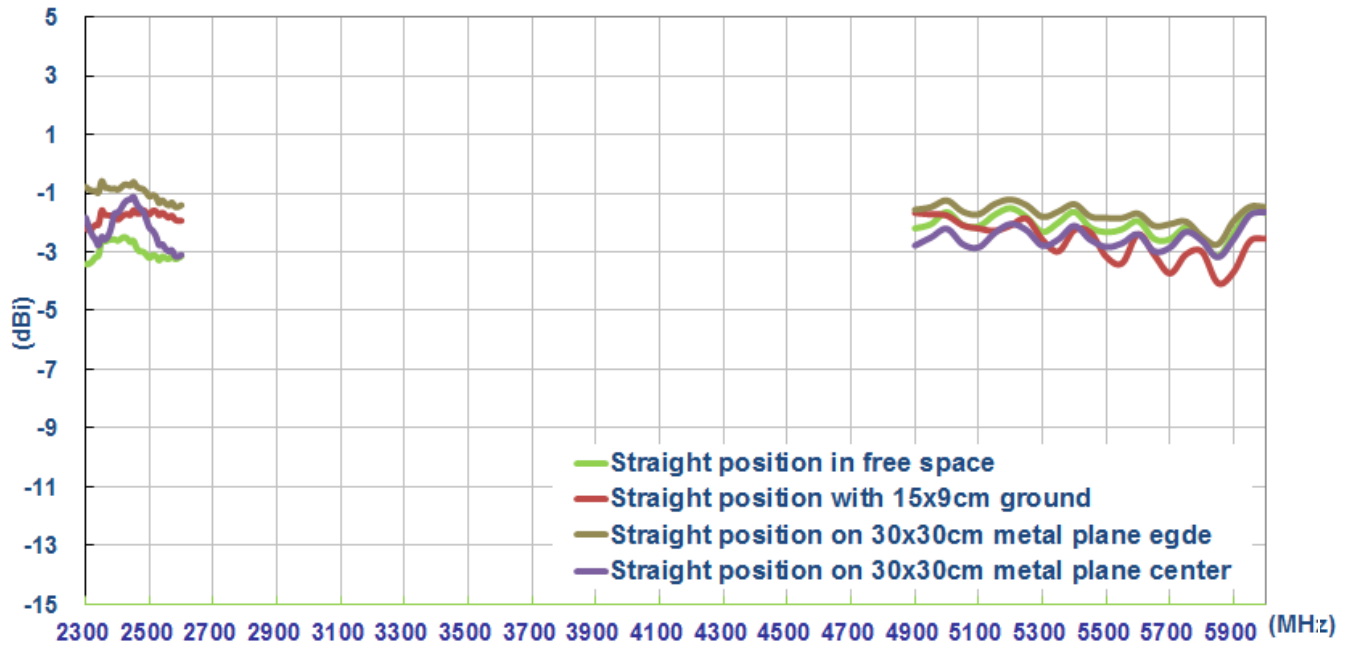

Figure8. Average gain of GW.05 with antenna straight position

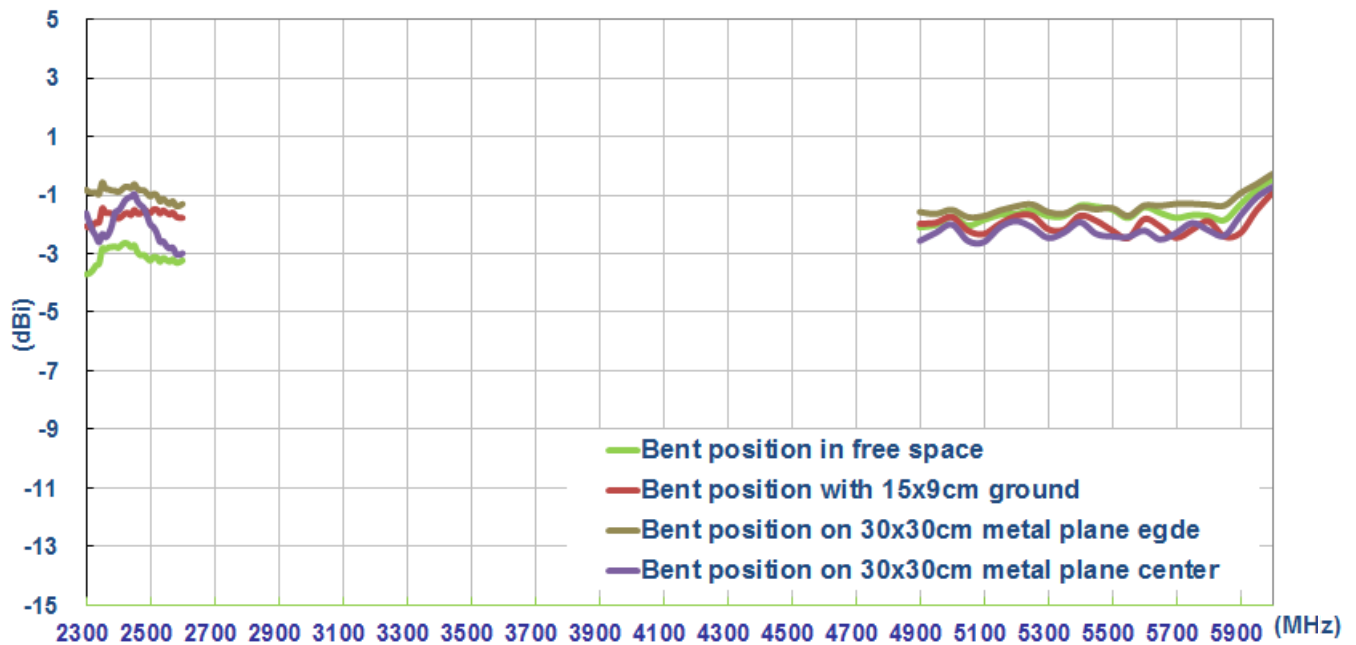
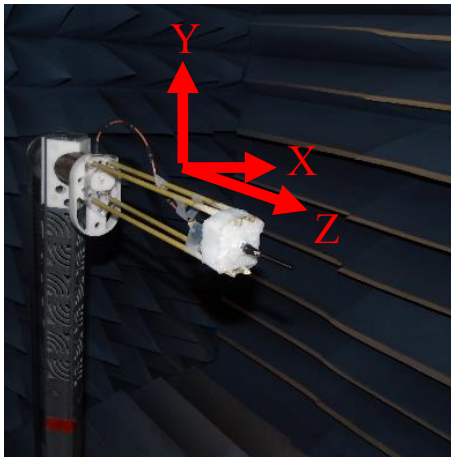

Figure9. Average gain of GW.05 antenna with bent position

4. Antenna Radiation Patterns

The antenna radiation patterns were measured in a CTIA certified ETS Anechoic Chamber. The measurement setup is shown below.

Antenna with Straight Position



In free space

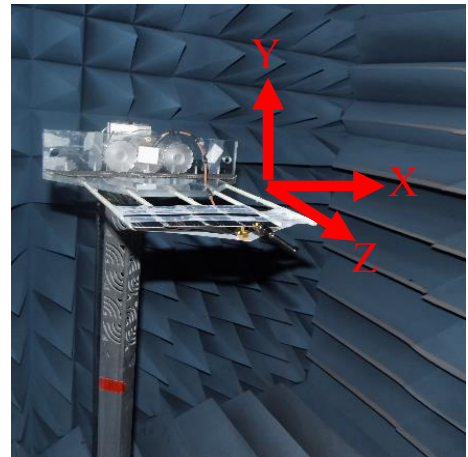

15x9cm ground plane



30x30cm metal ground center

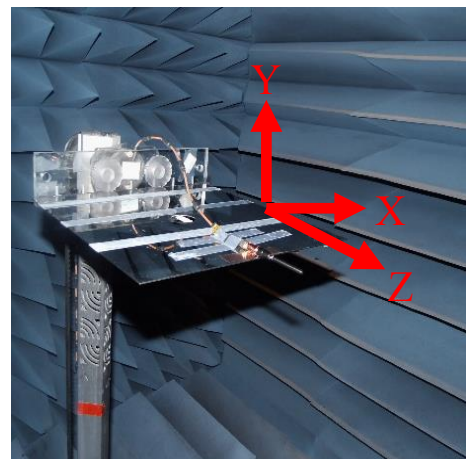

30x30cm metal ground edge

Antenna Bent Position



In free space

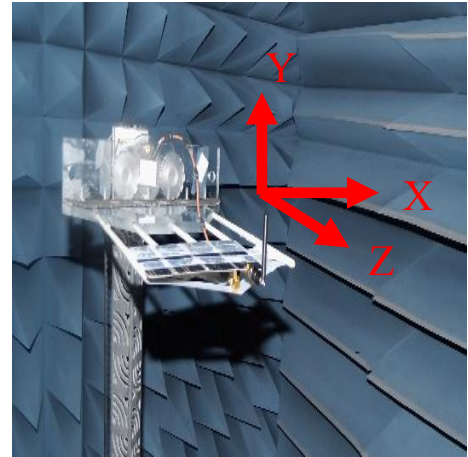

15x9cm ground plane

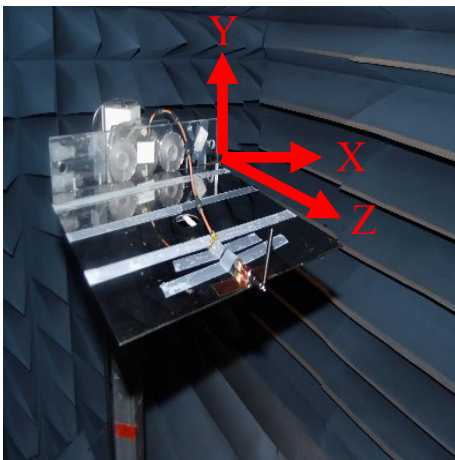

30x30cm metal ground center

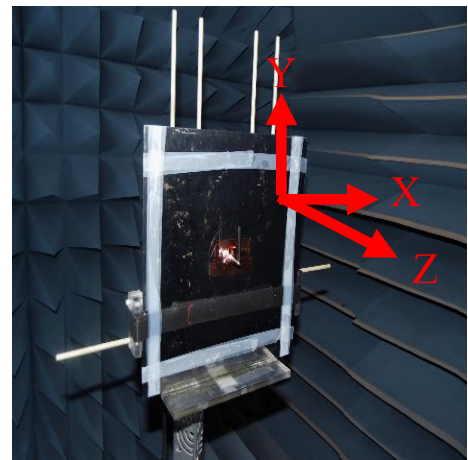

30x30cm metal ground edge

Figure.10. Testing Setup in ETS Anechoic Chamber

4.1 2D Radiation Pattern (Straight position in free space)

XY Plane

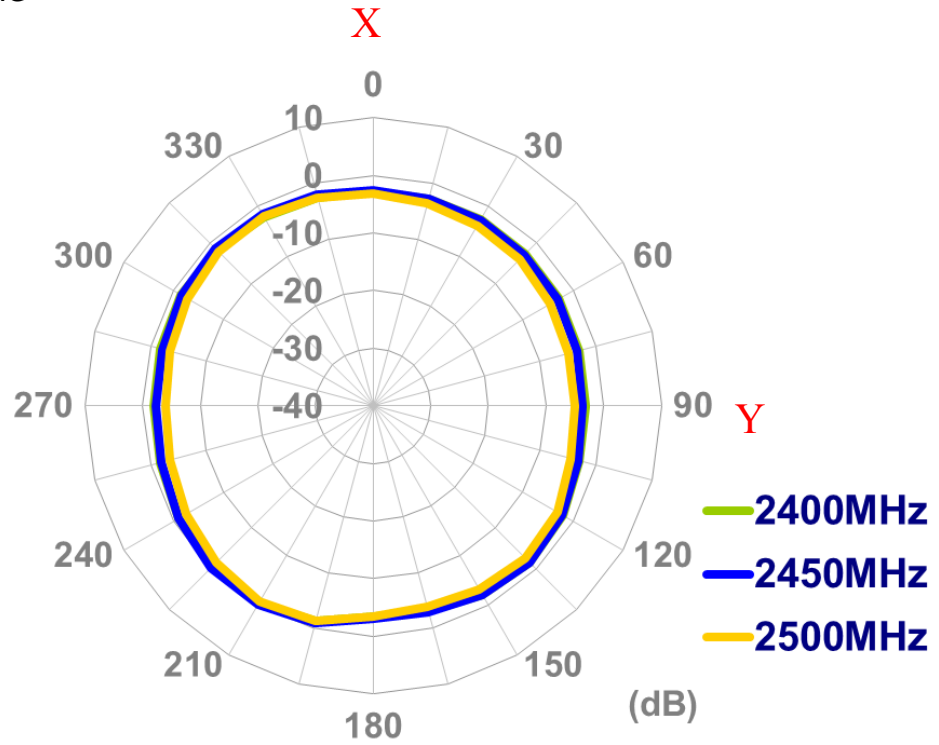

XY Plane

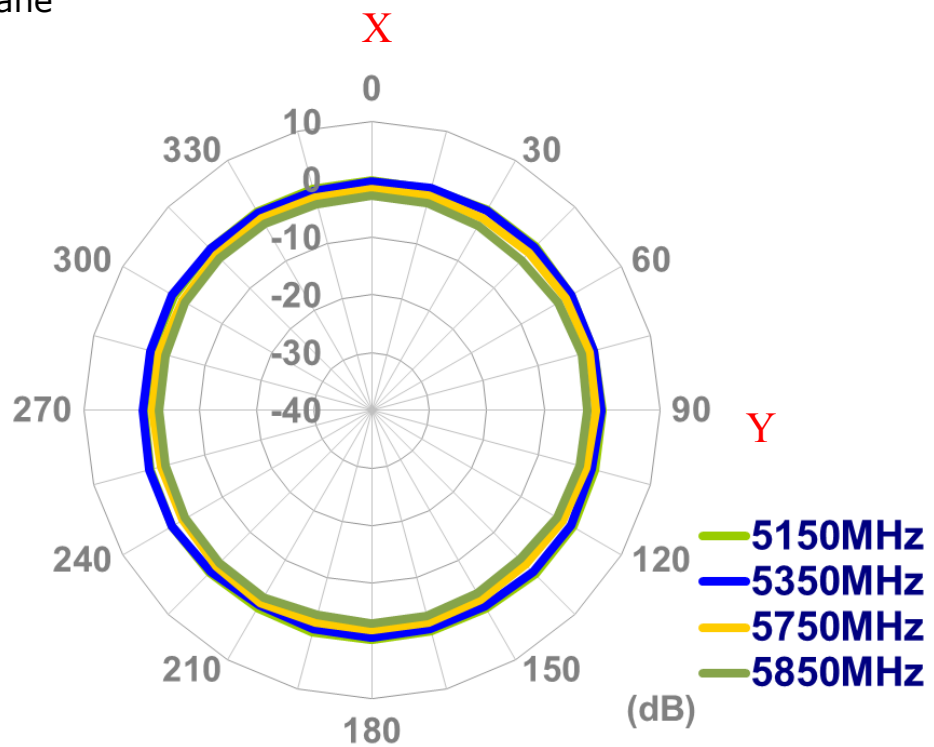

XZ Plane

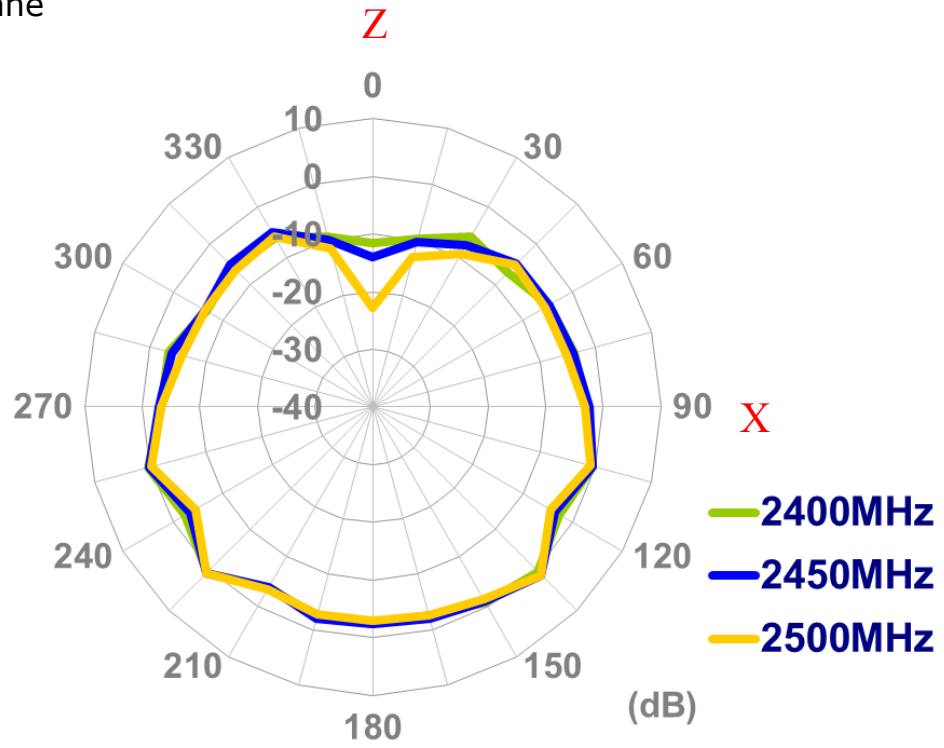

XZ Plane

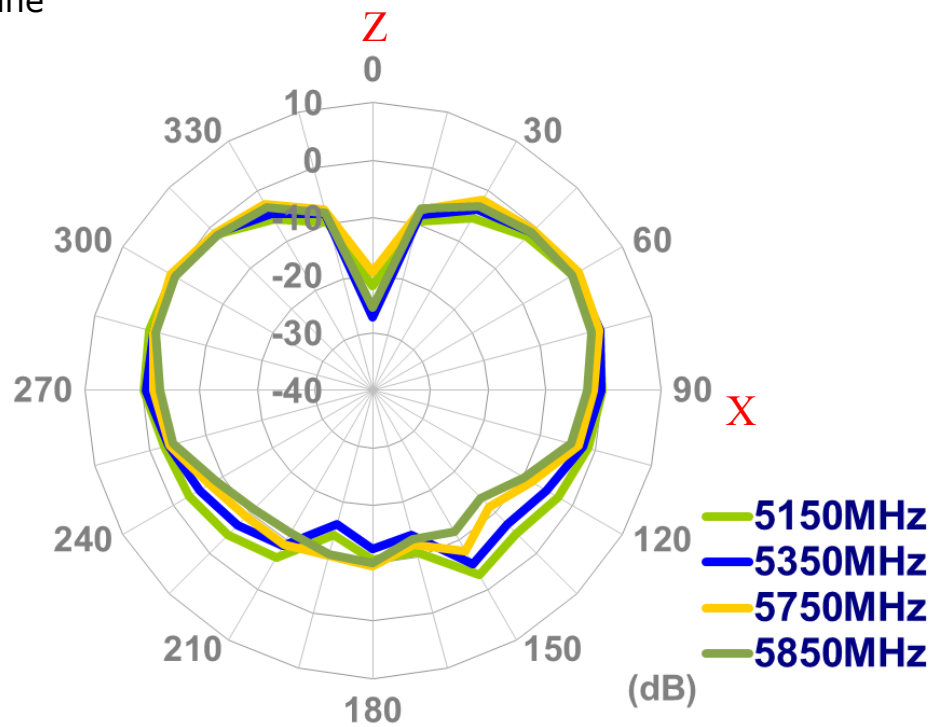

YZ Plane

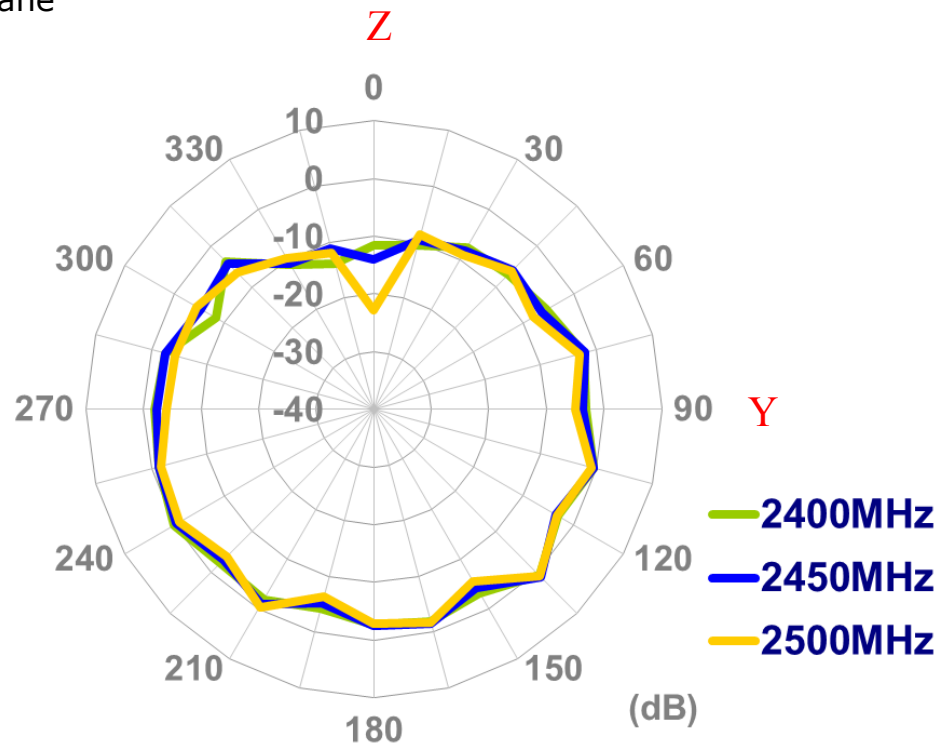

YZ Plane

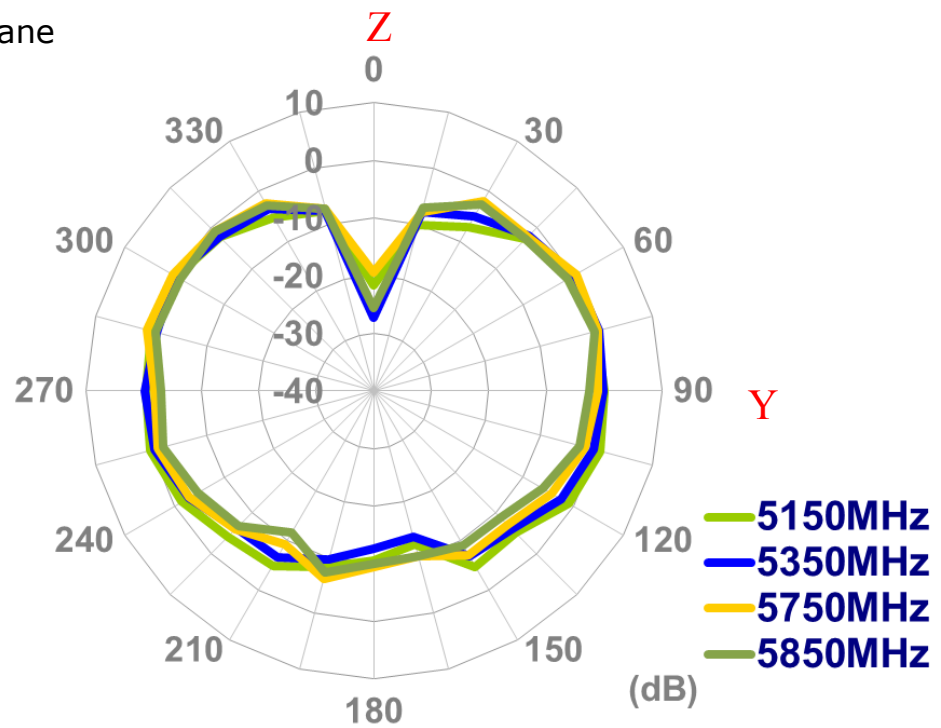

4.2 2D Radiation Pattern (Straight position with 15x9cm ground plane)

XY Plane

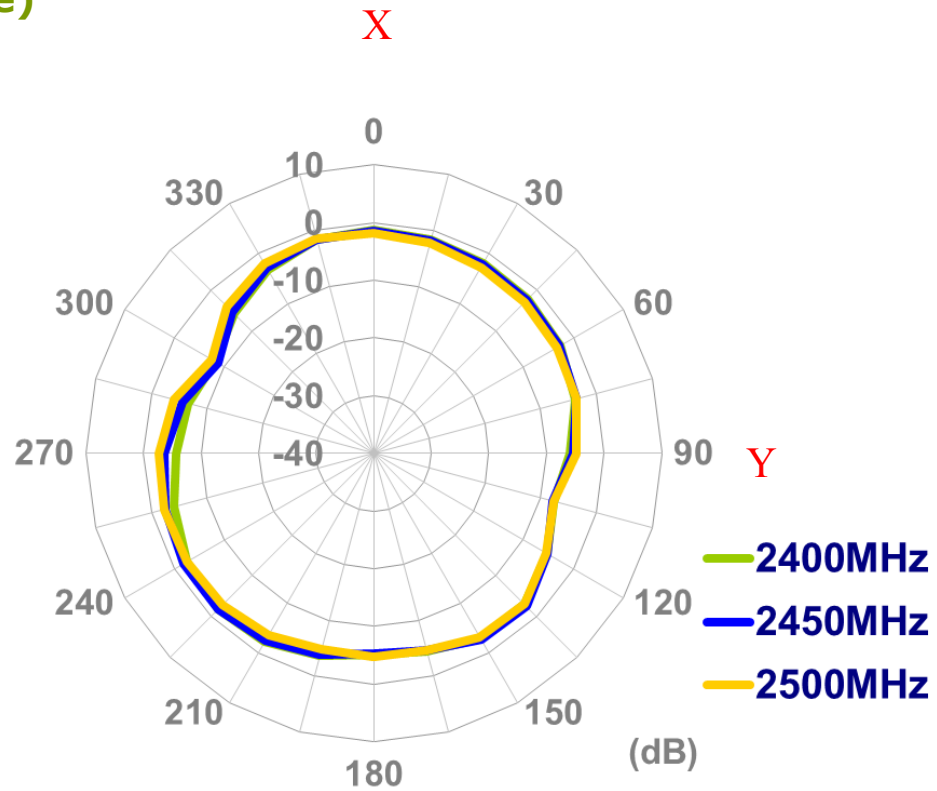

XY Plane

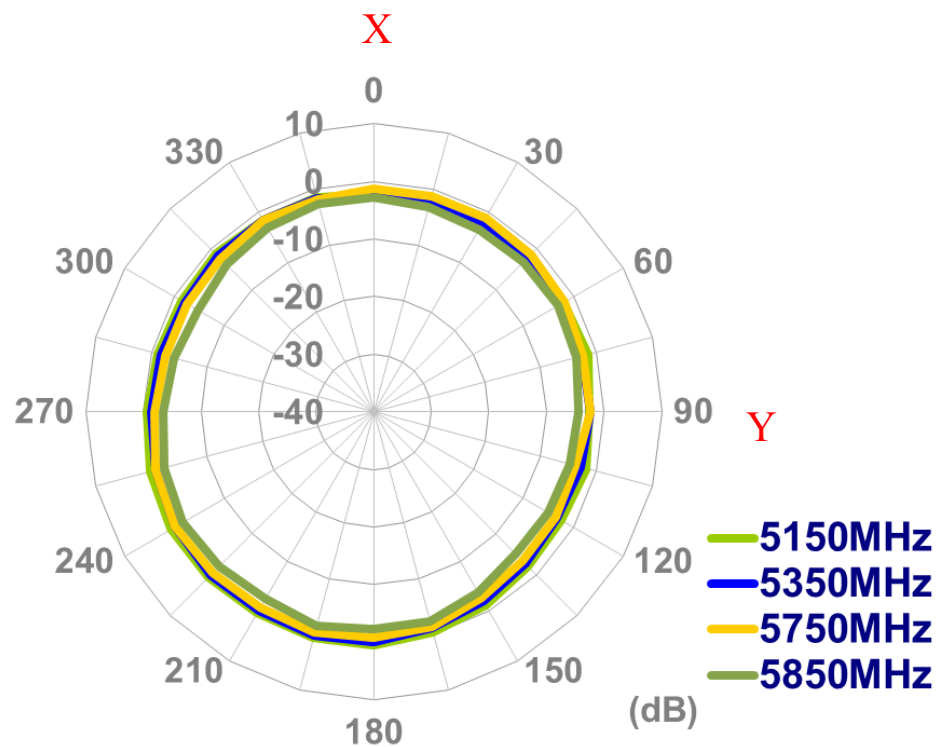

XZ Plane

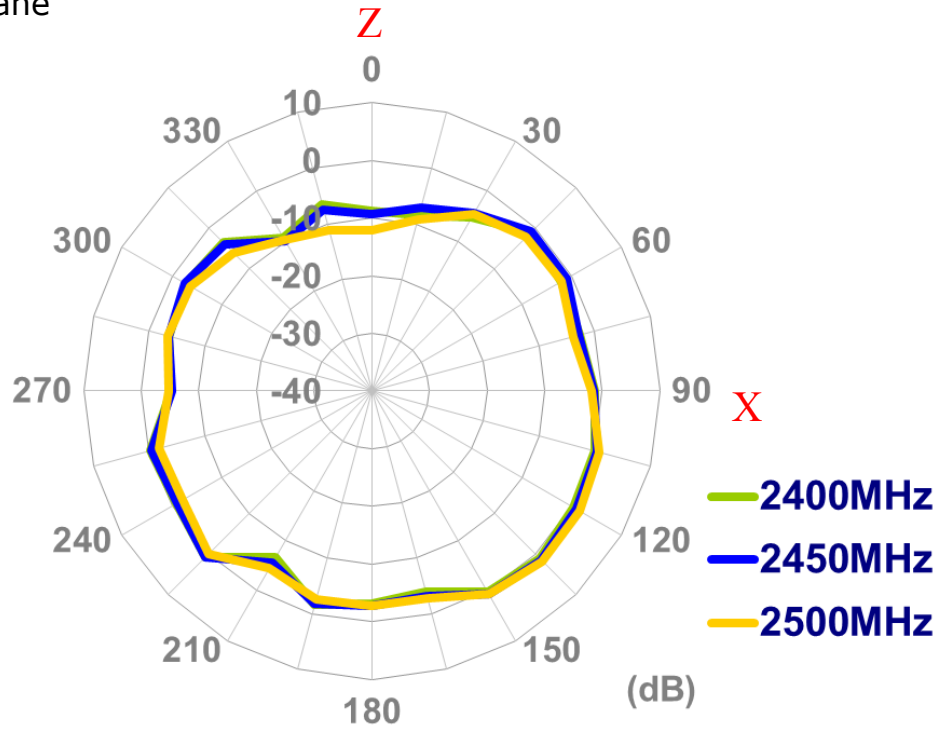

XZ Plane

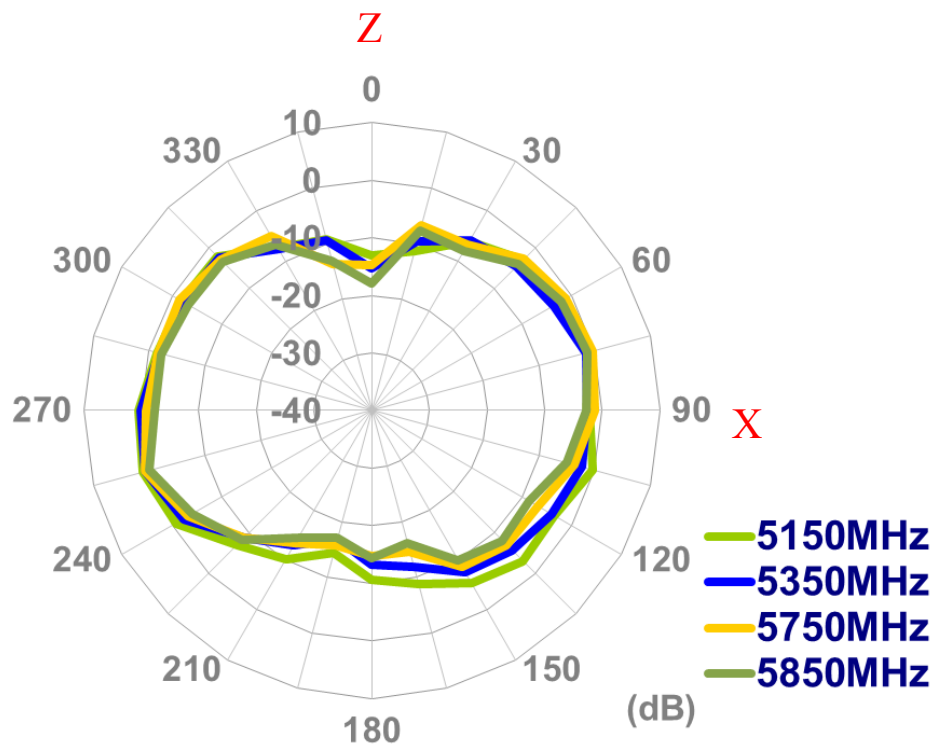

YZ Plane

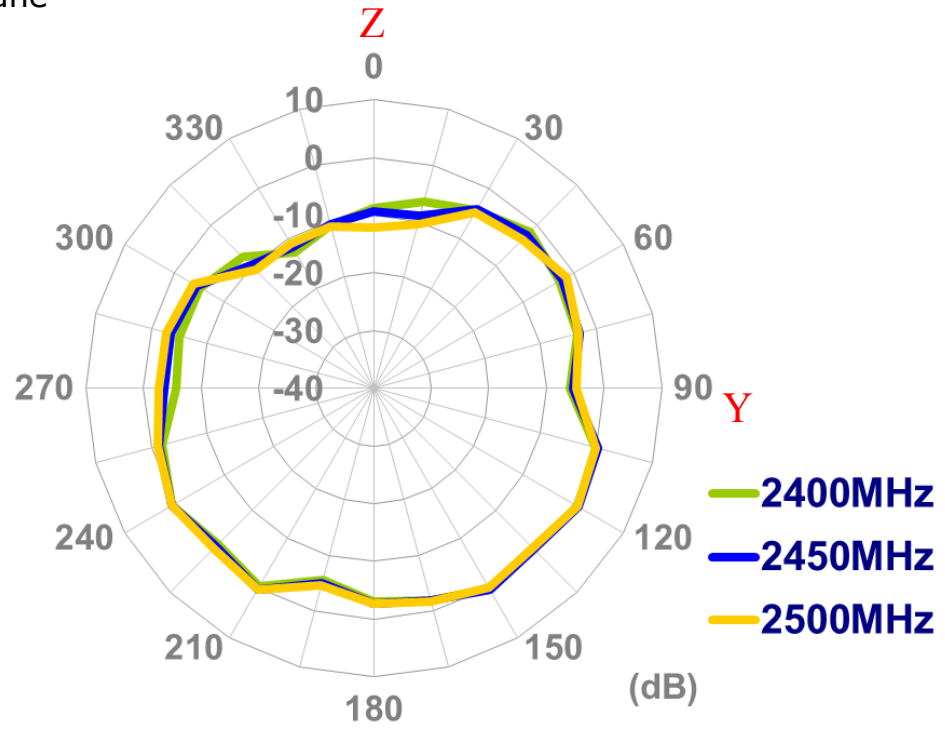

YZ Plane

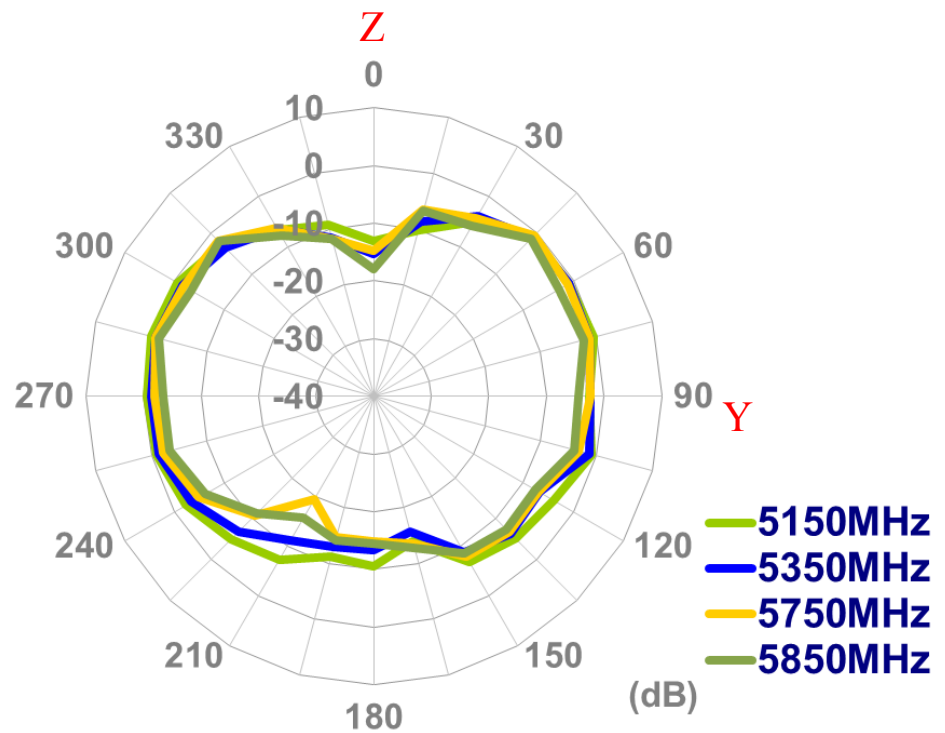

4.3 2D Radiation Pattern (Straight position with 30x30cm ground plane edge)

XY Plane

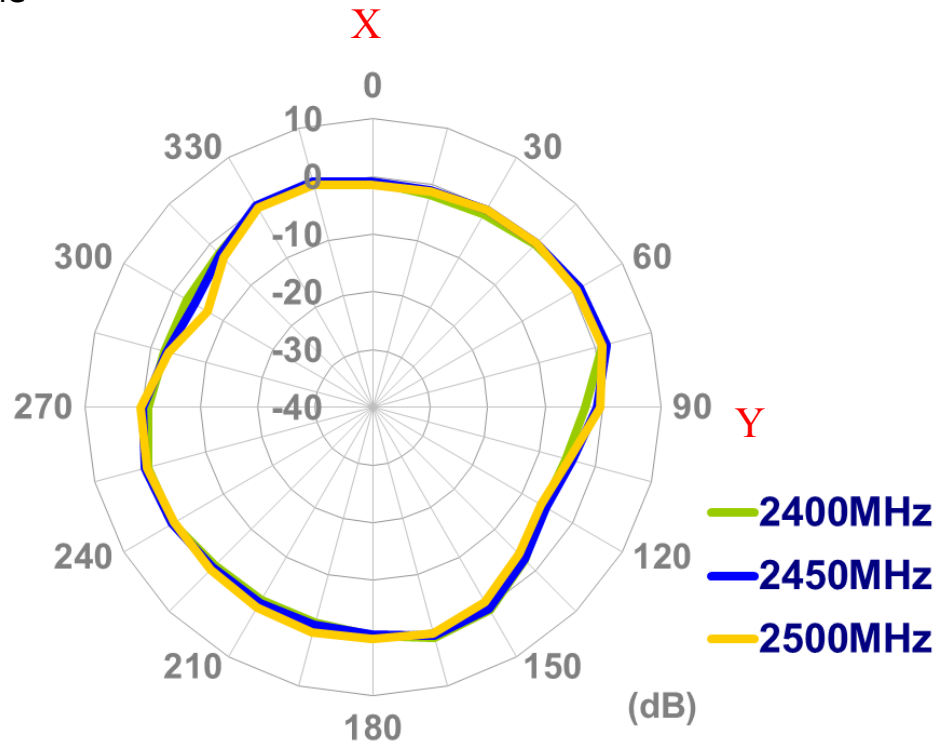

XY Plane

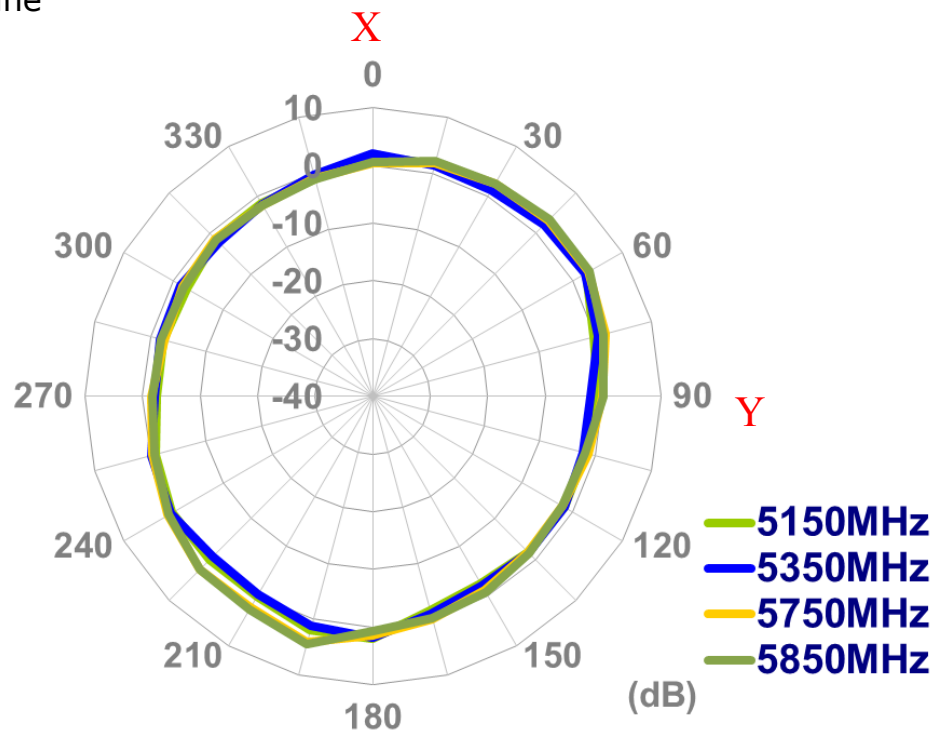

XZ Plane

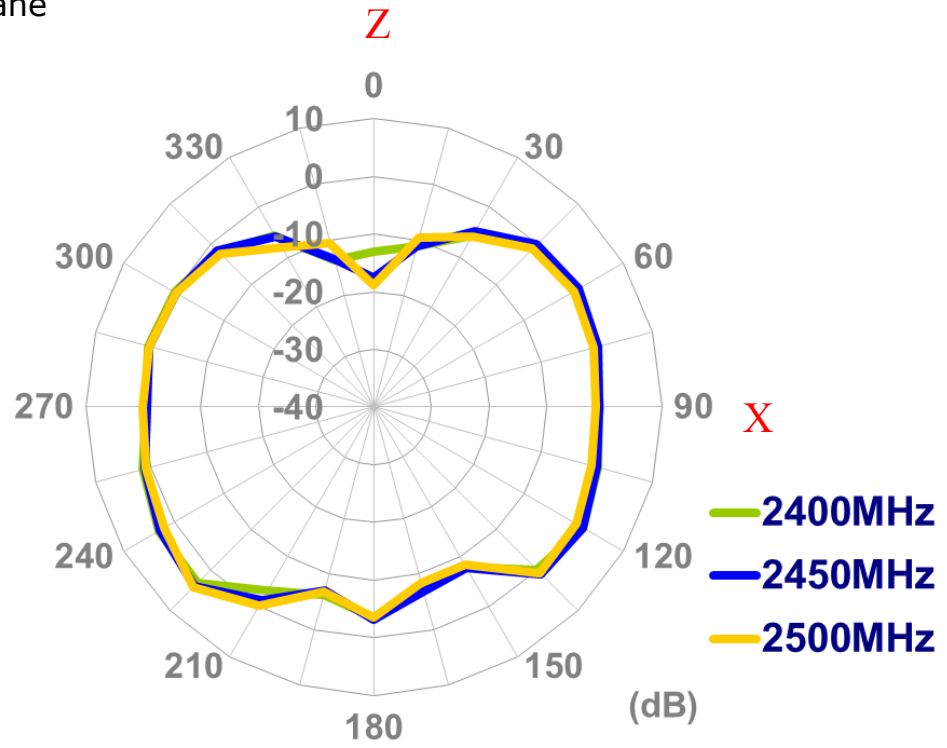

XZ Plane

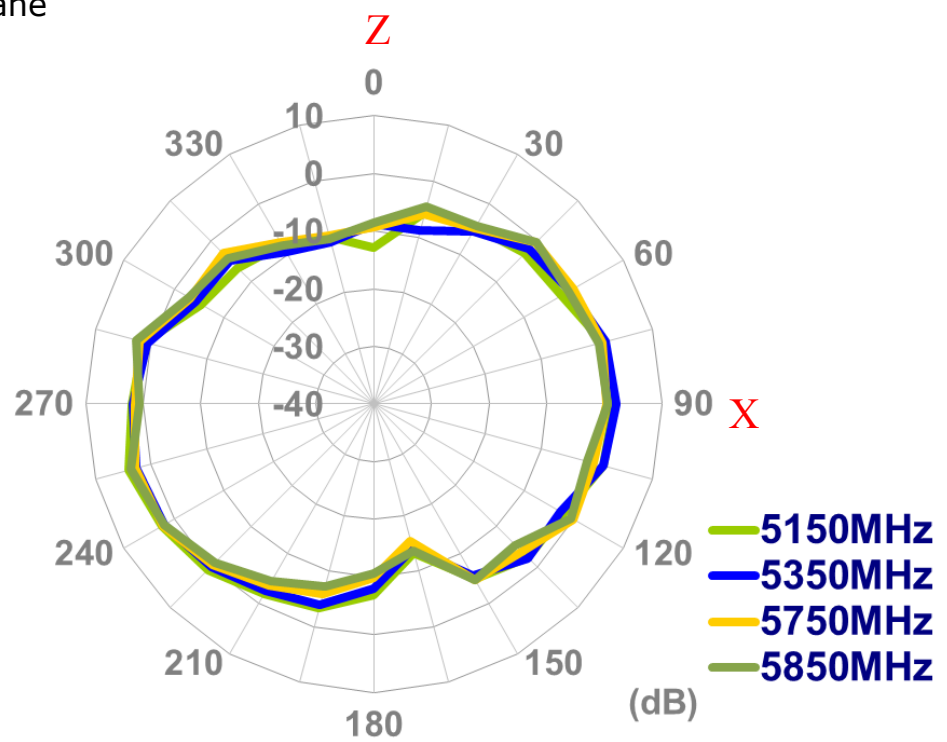

YZ Plane

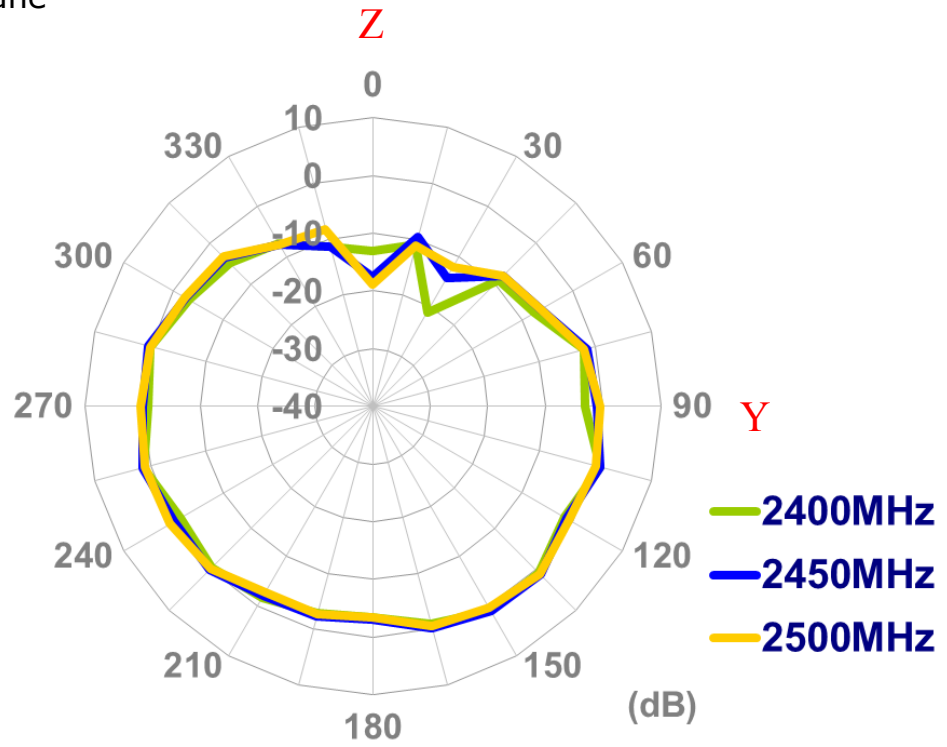

YZ Plane

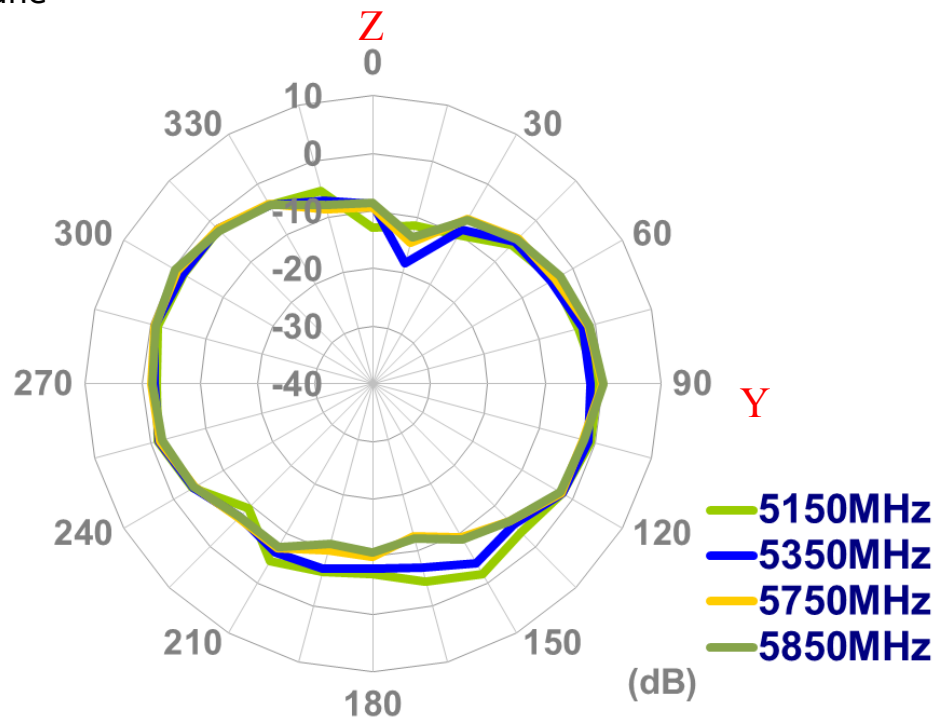

4.4 2D Radiation Pattern (Straight position with 30x30cm ground plane center)

XY Plane

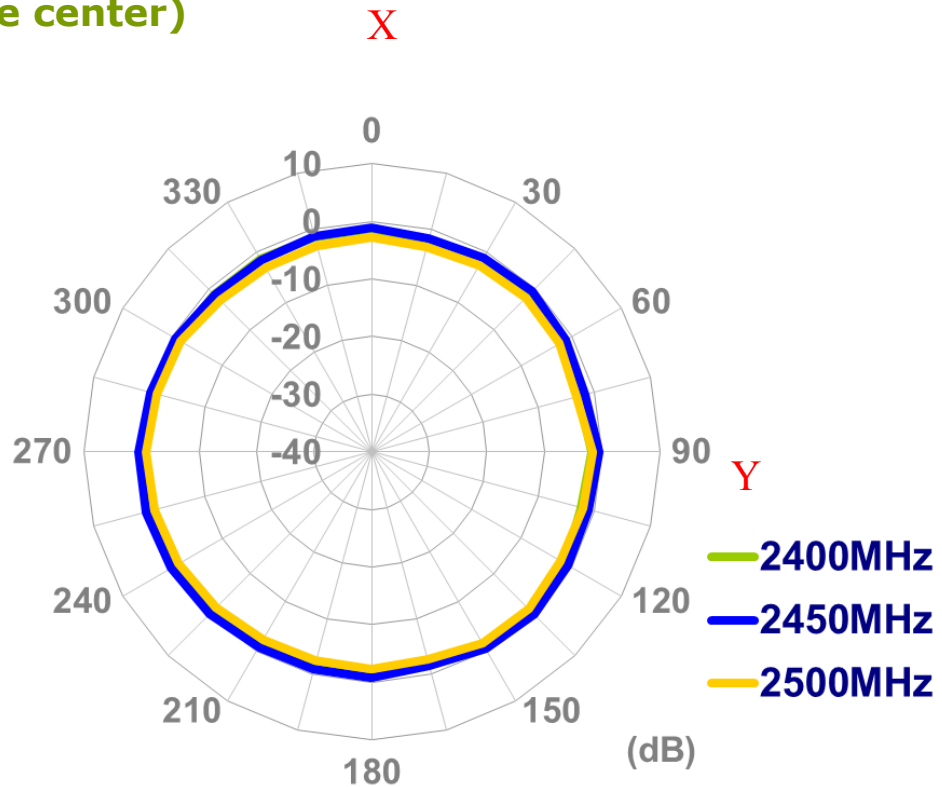

XY Plane

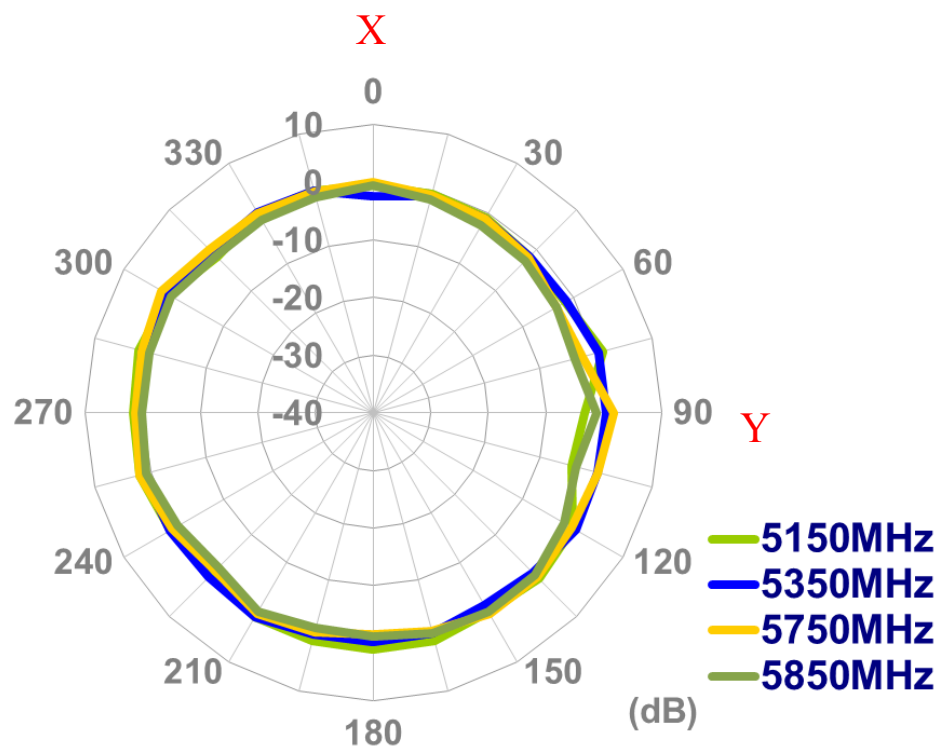

XZ Plane

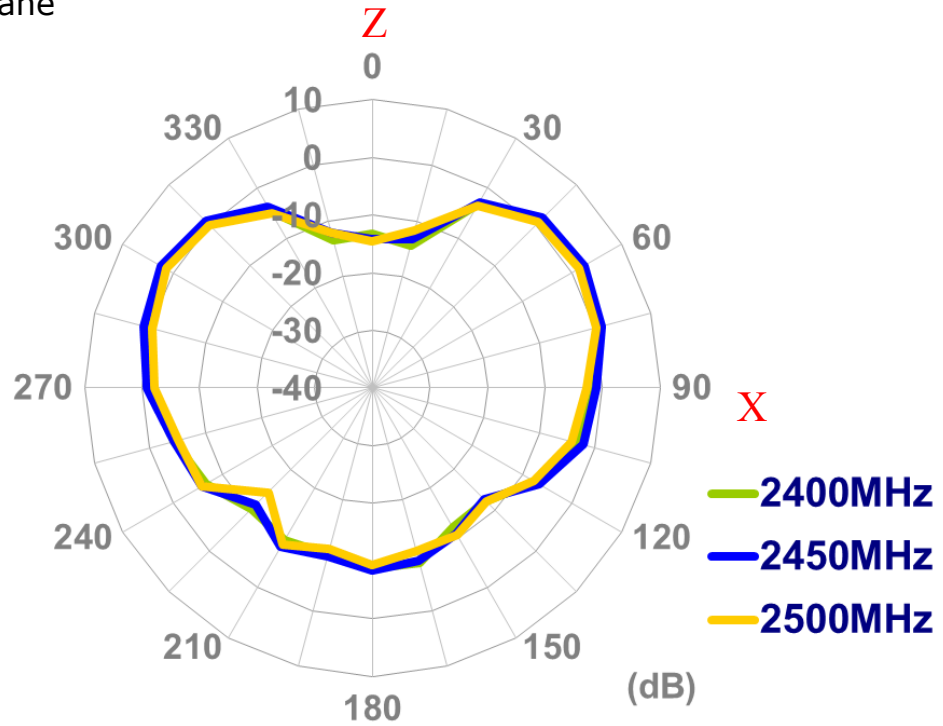

XZ Plane

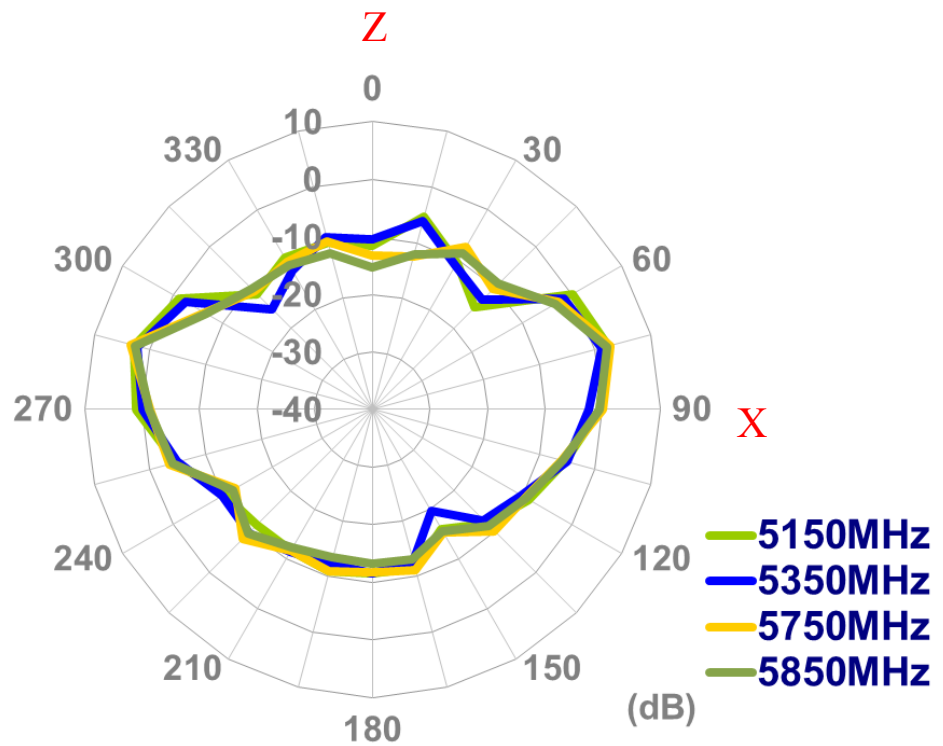

YZ Plane

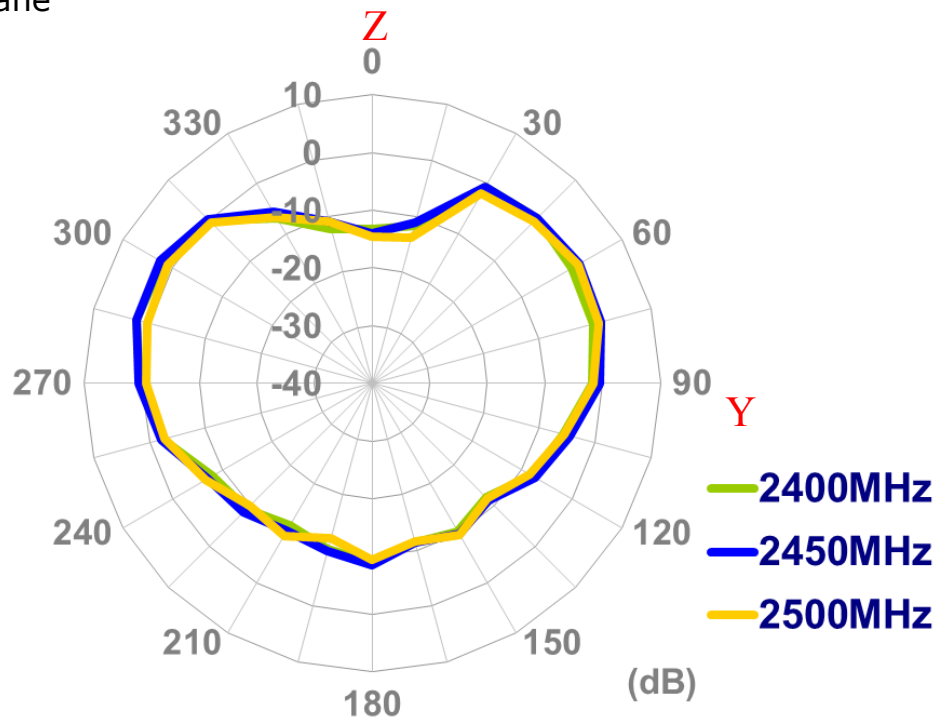

YZ Plane

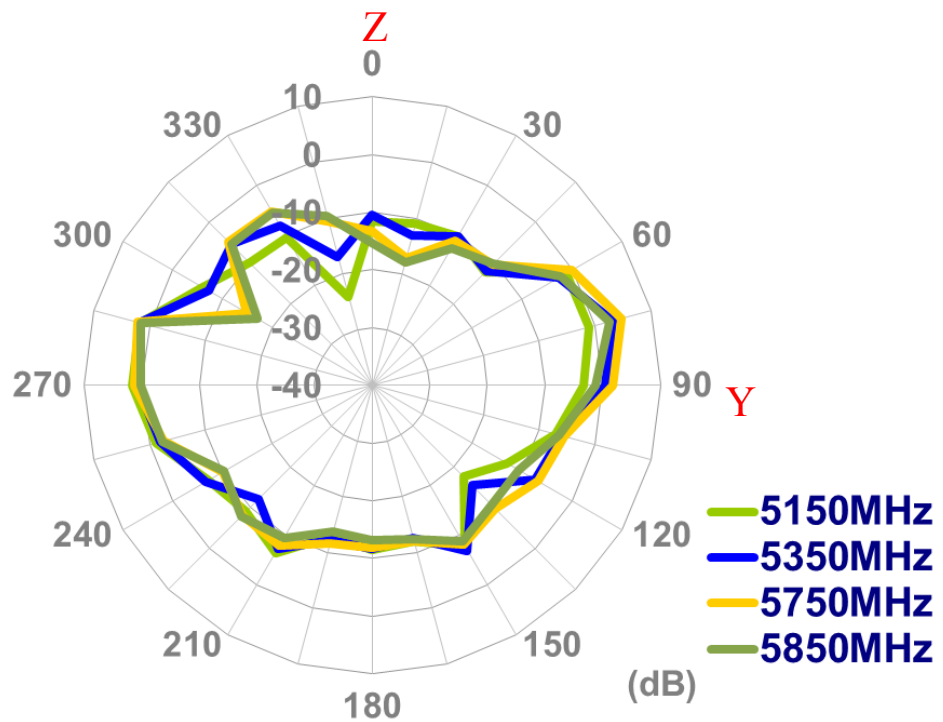

4.5 2D Radiation Pattern (Bent position in free space)

XY Plane

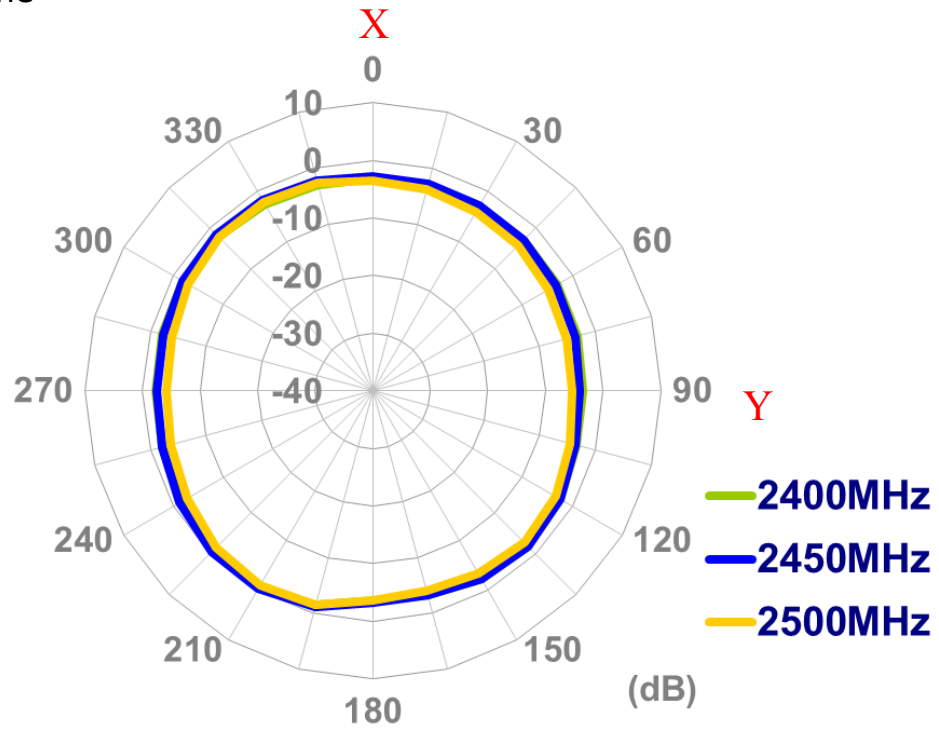

XY Plane

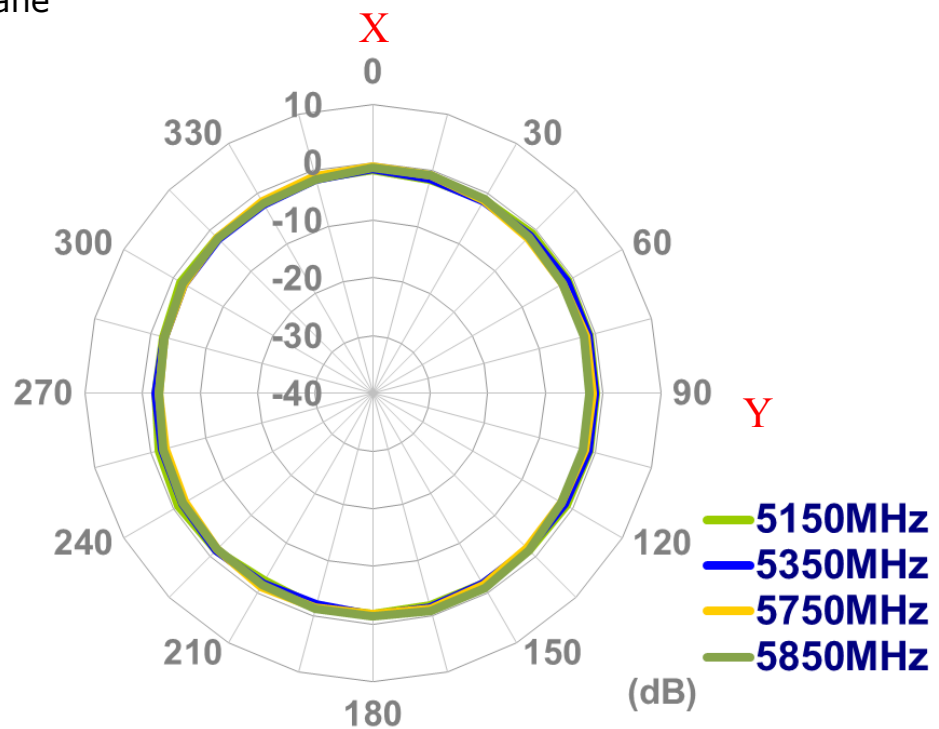

XZ Plane

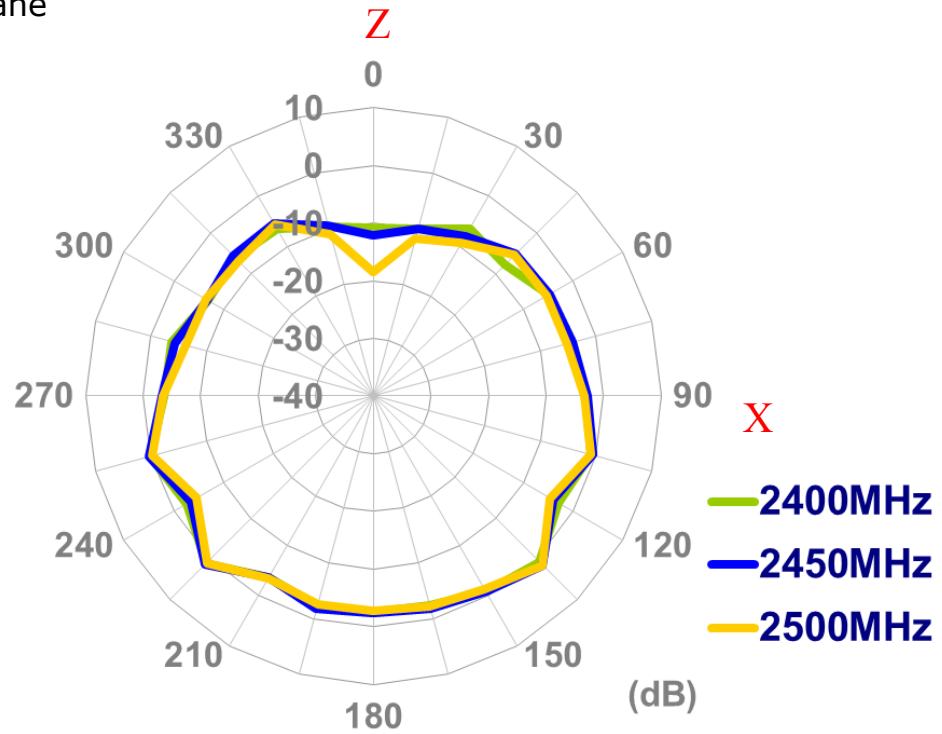

XZ Plane

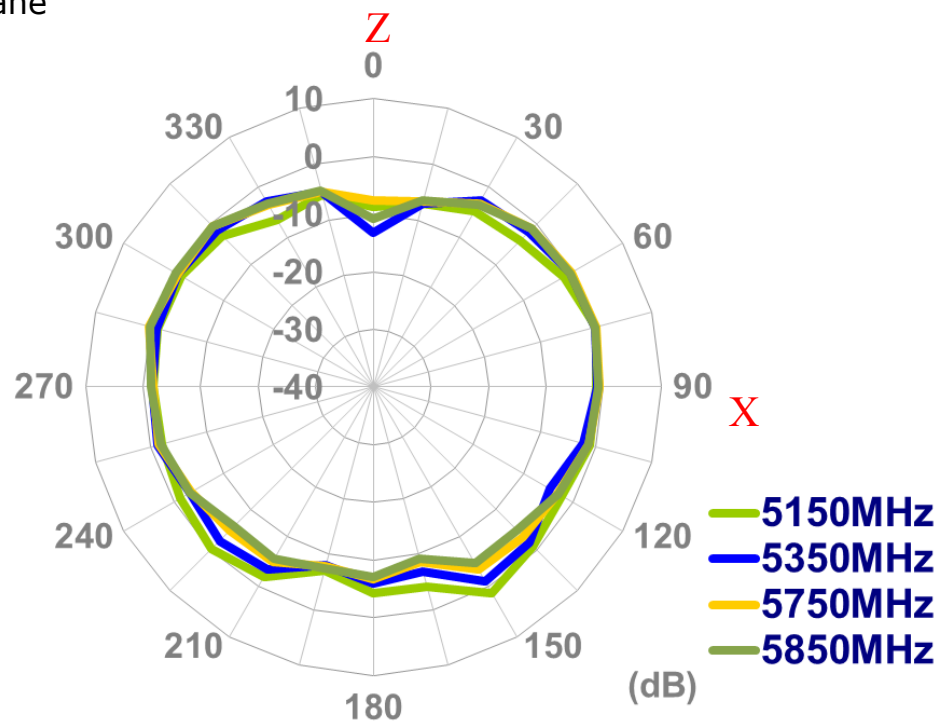

YZ Plane

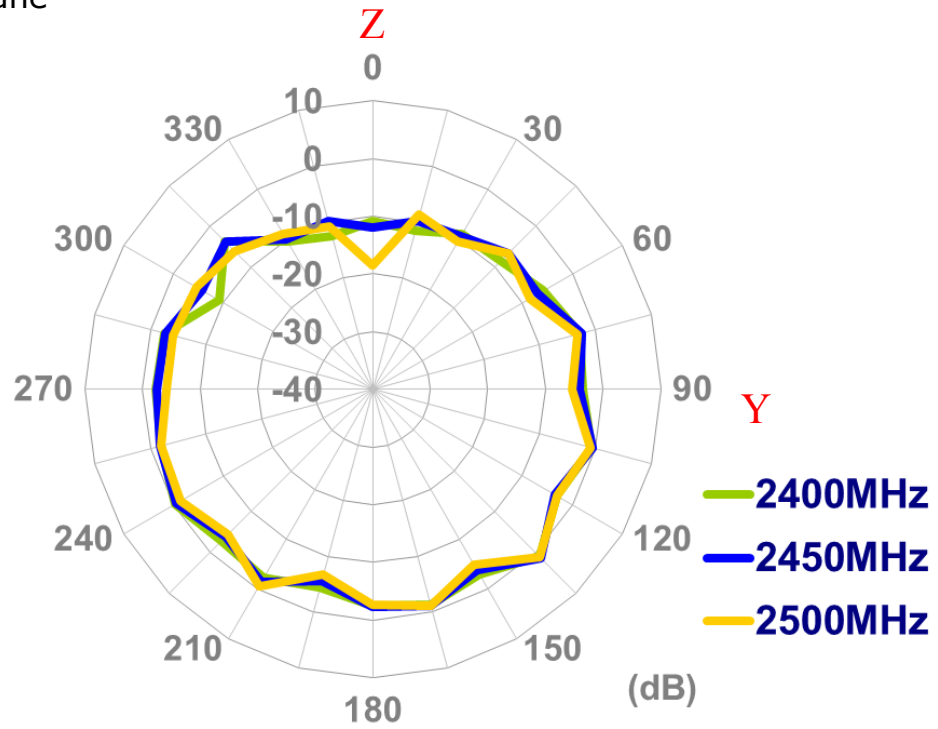

YZ Plane

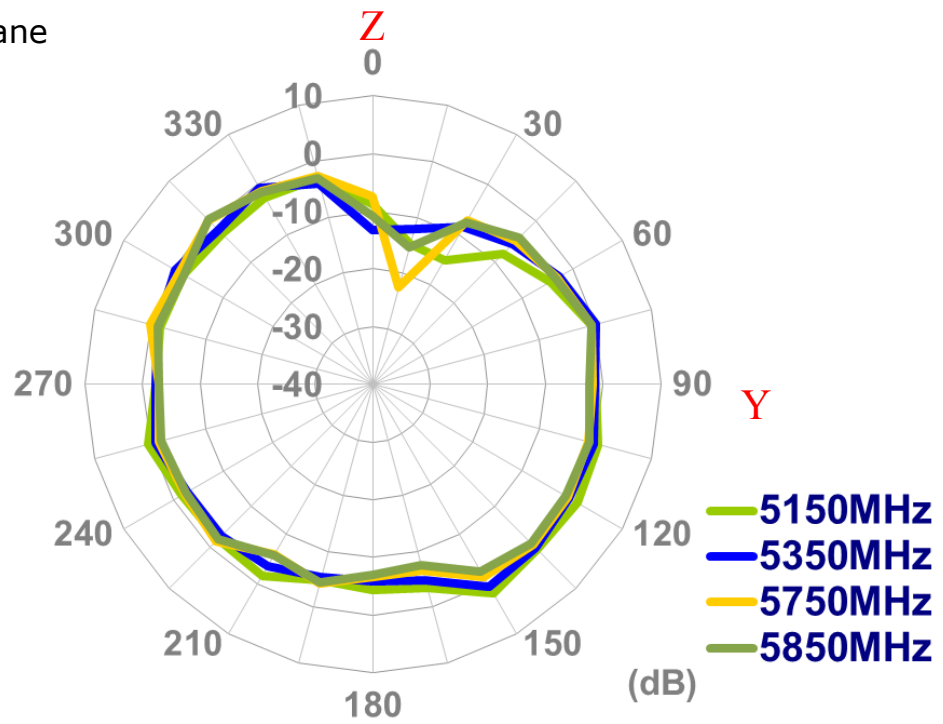

4.6 2D Radiation Pattern (Bent position with 15x9cm ground plane)

XY Plane

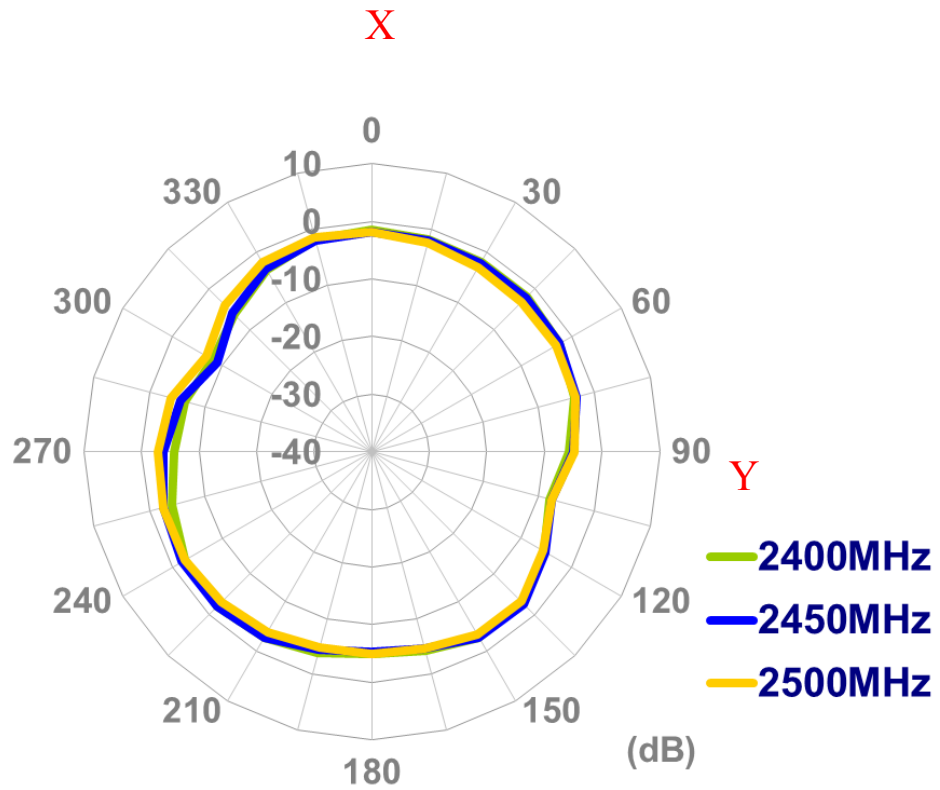

XY Plane

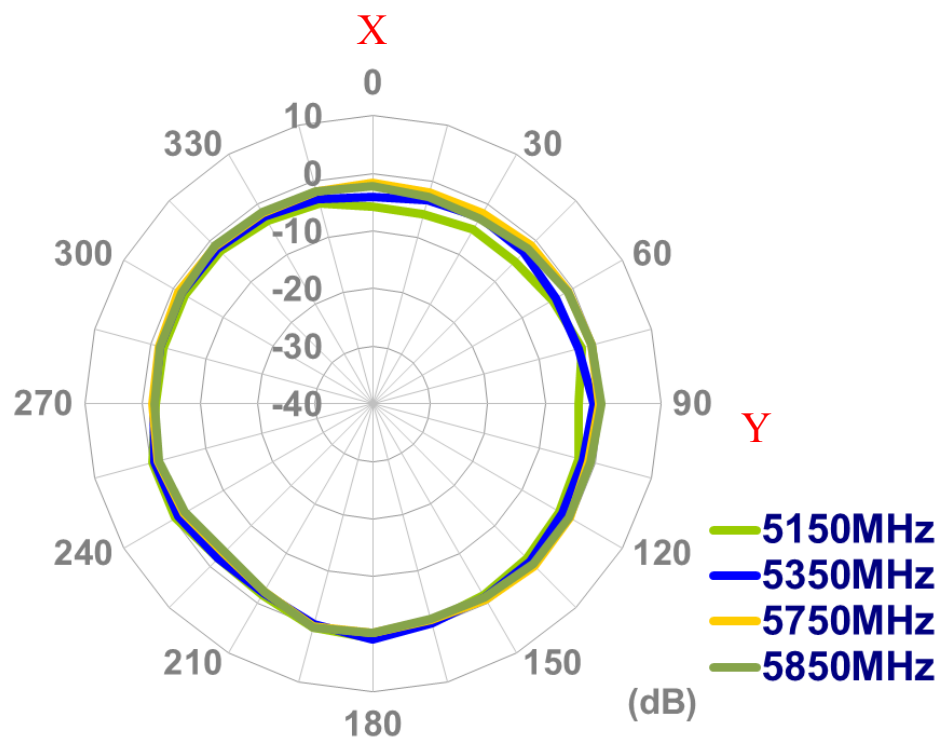

XZ Plane

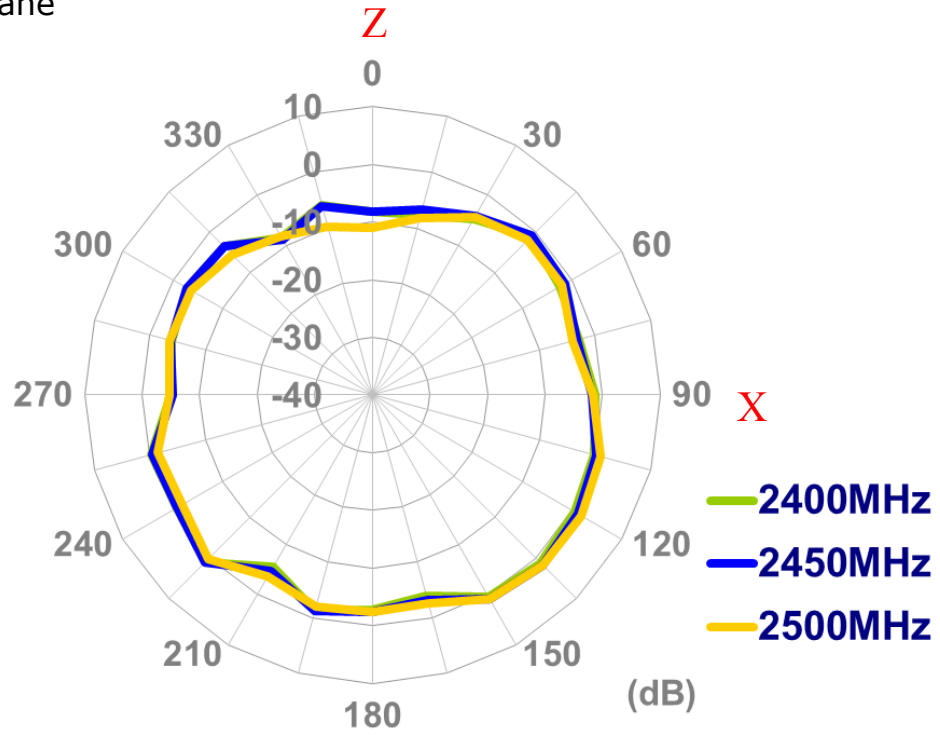

XZ Plane

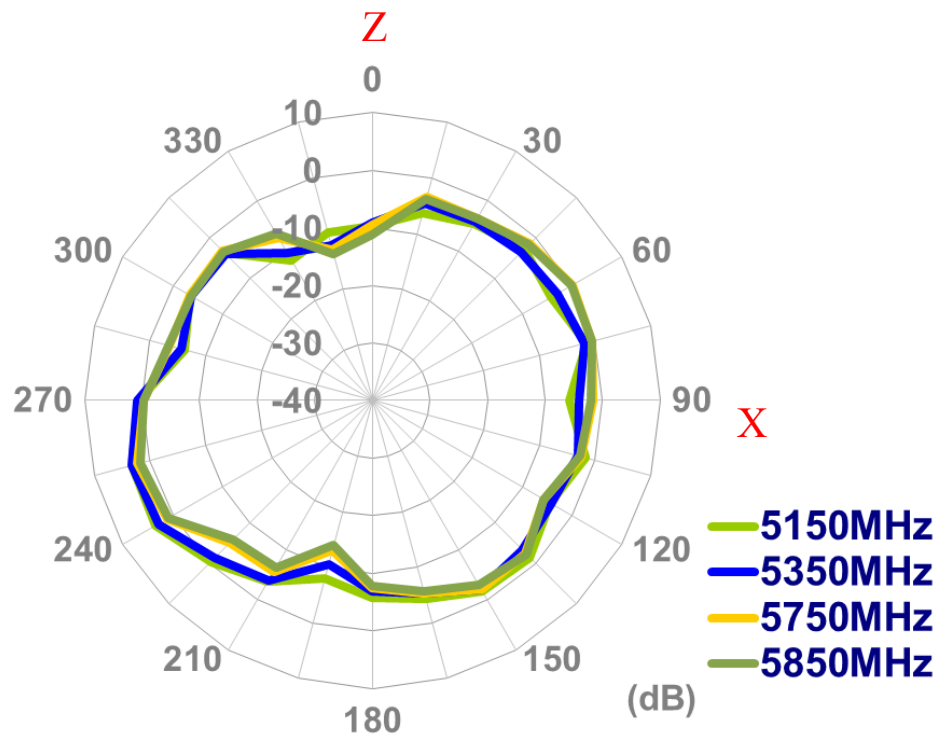

YZ Plane

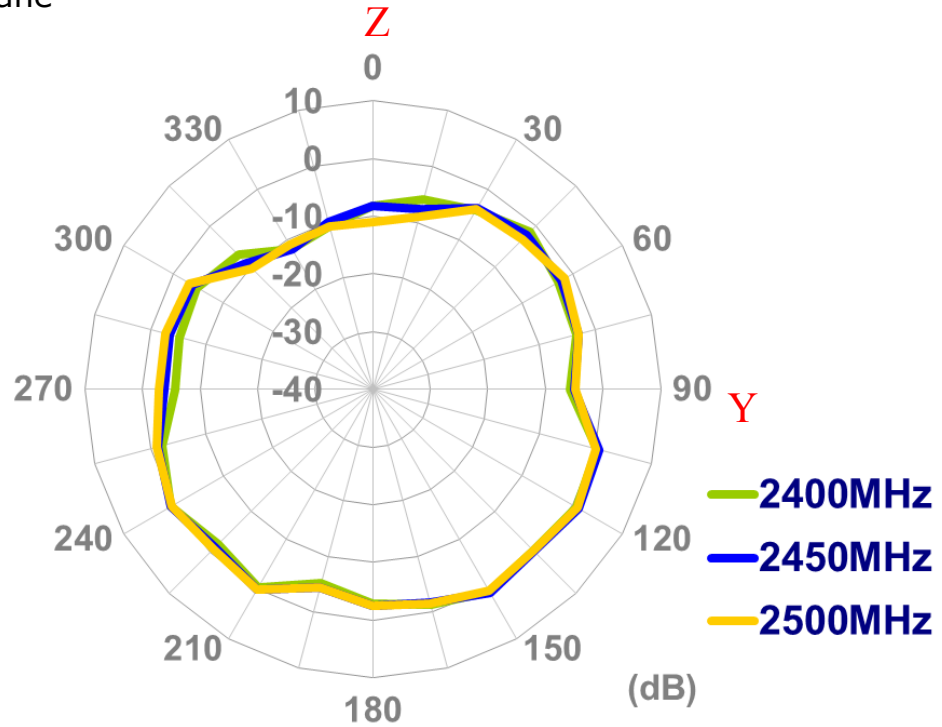

YZ Plane

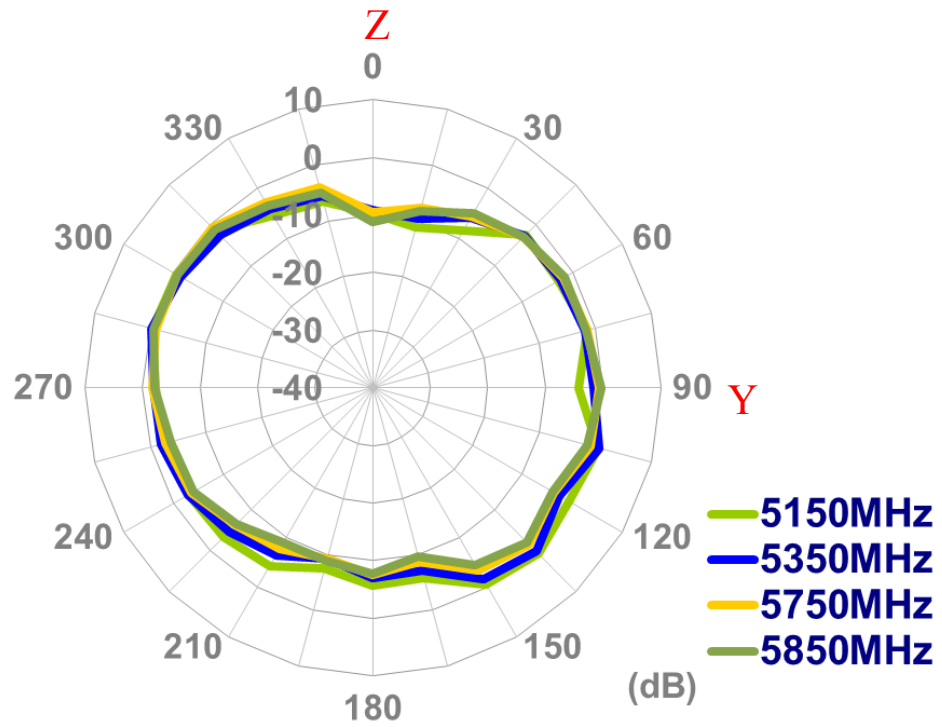

4.7 2D Radiation Pattern (Bent position with 30x30cm ground plane edge)

XY Plane

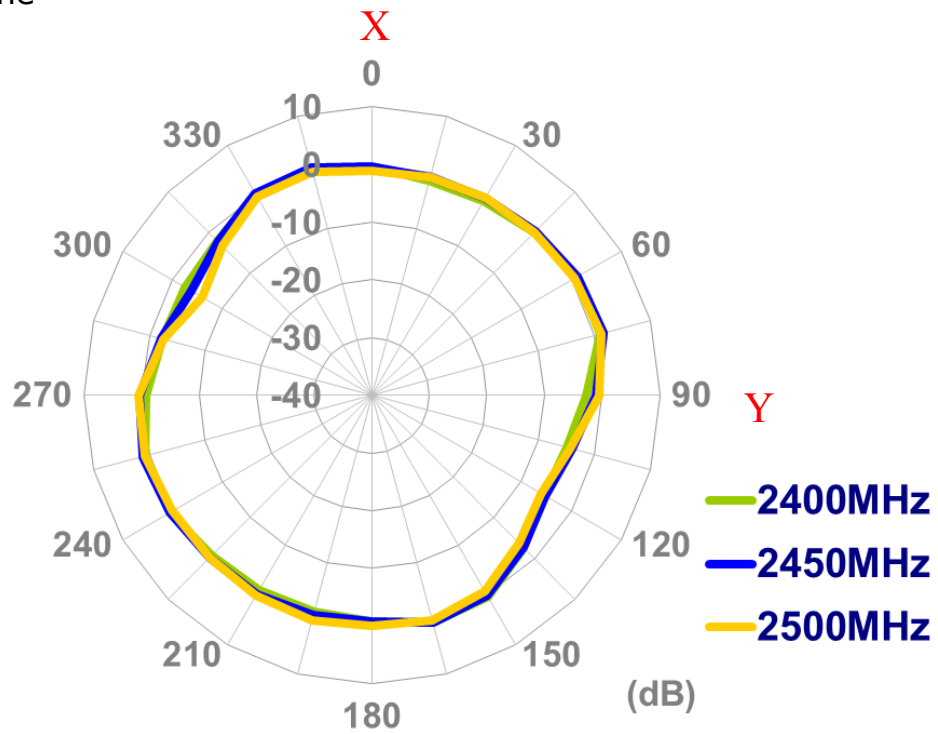

XY Plane

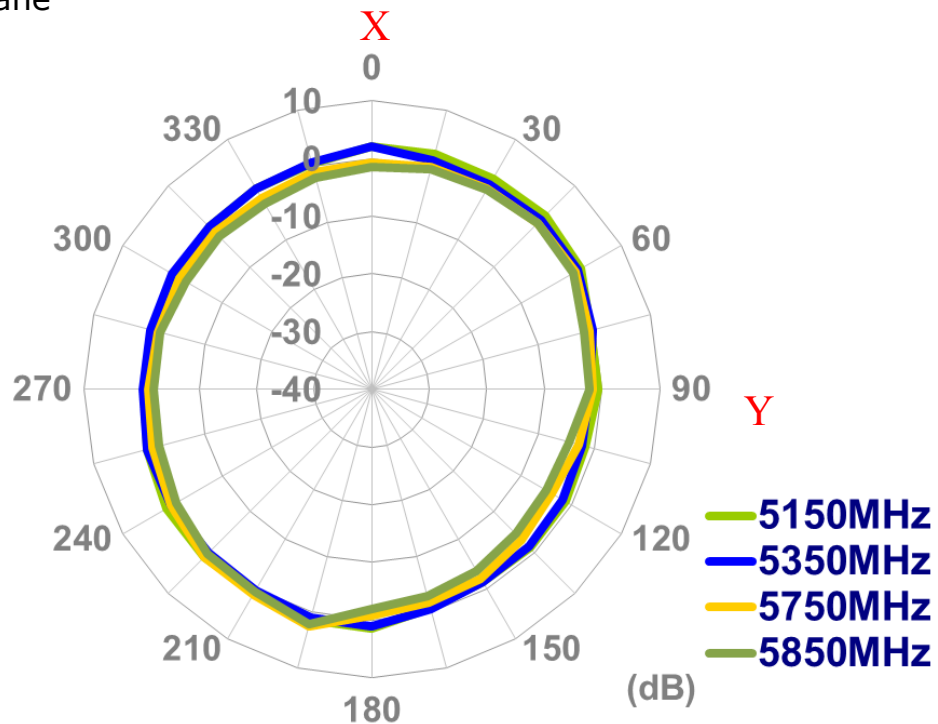

XZ Plane

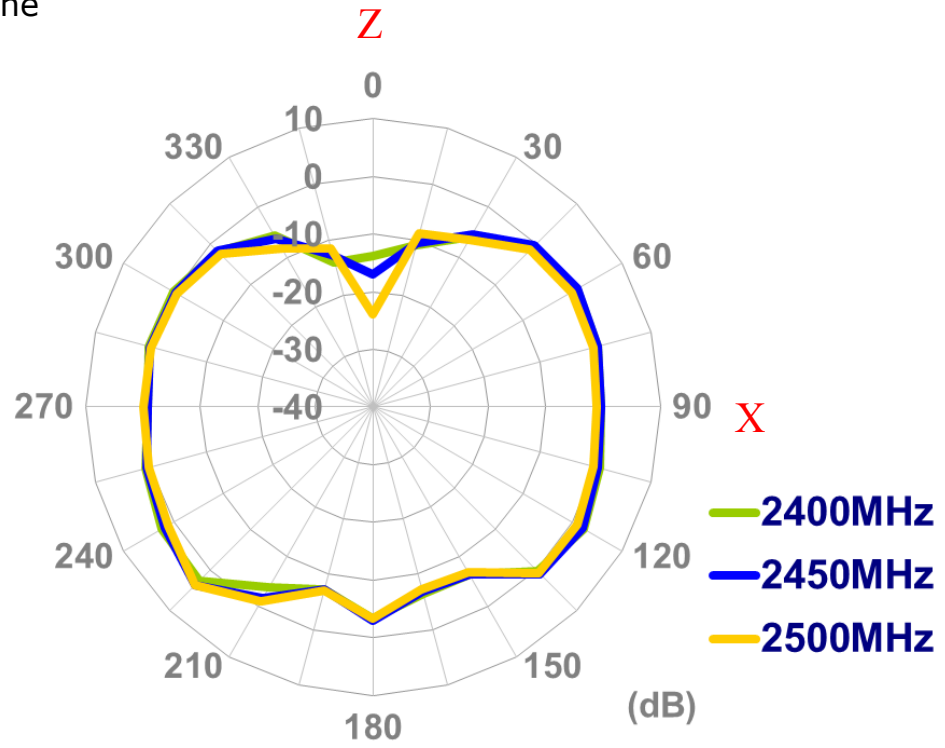

XZ Plane

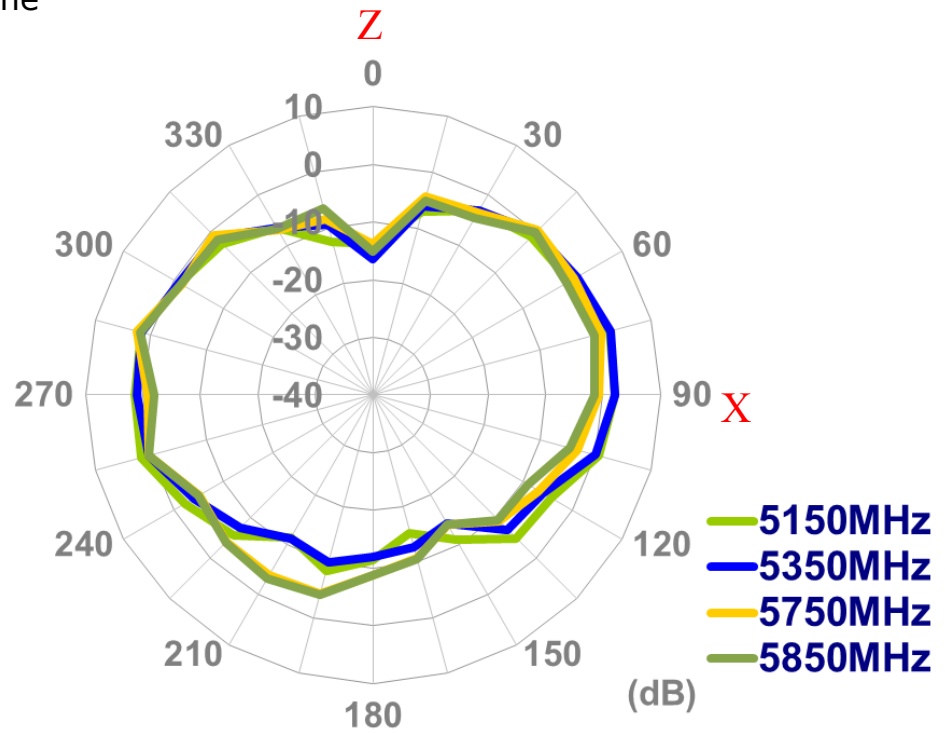

YZ Plane

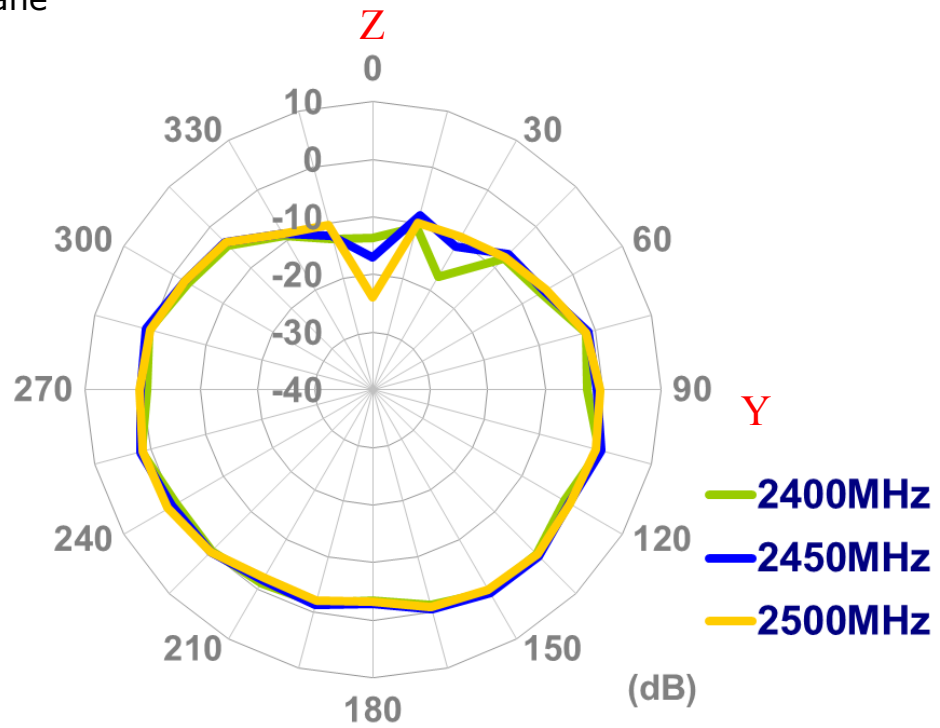

YZ Plane

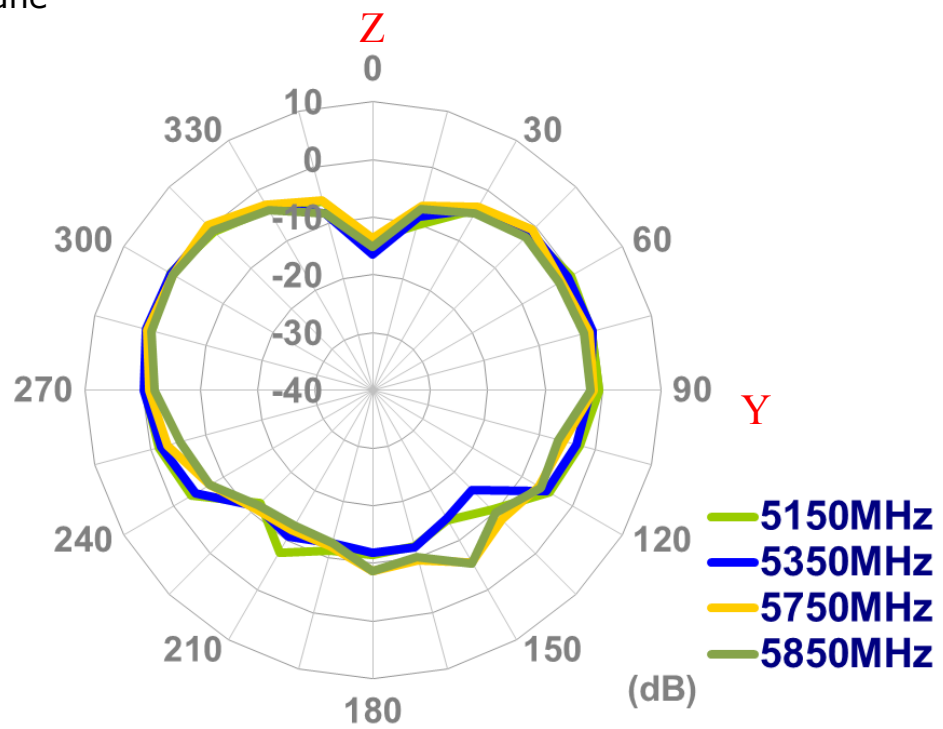

4.8 2D Radiation Pattern (Bent position with 30*30cm ground plane center)

XY Plane

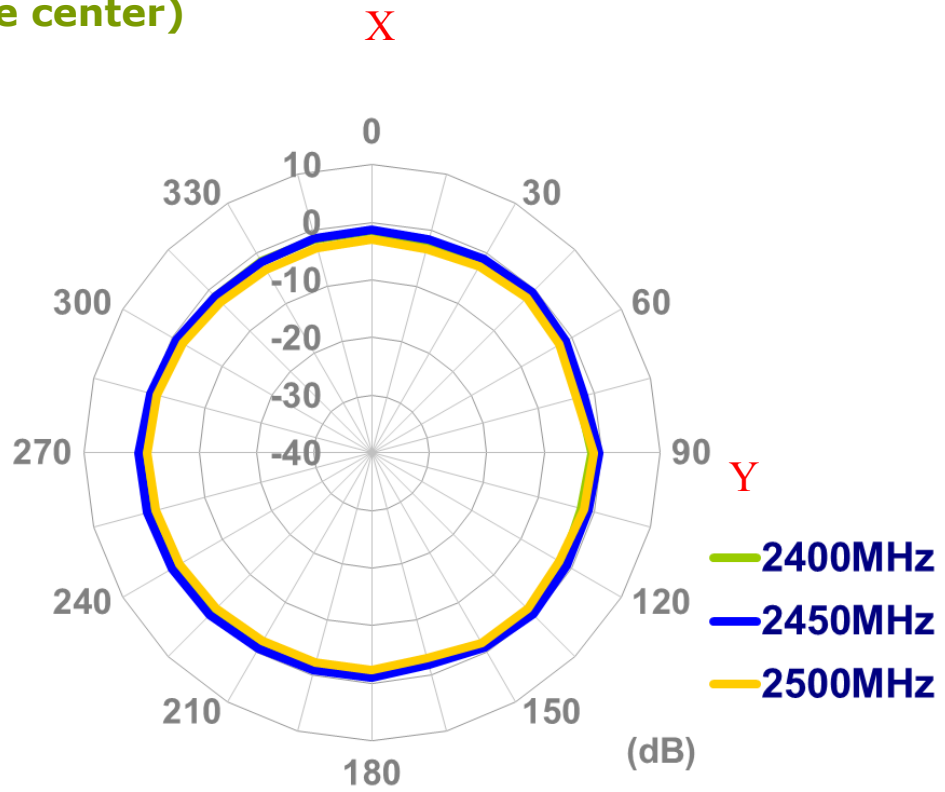

XY Plane

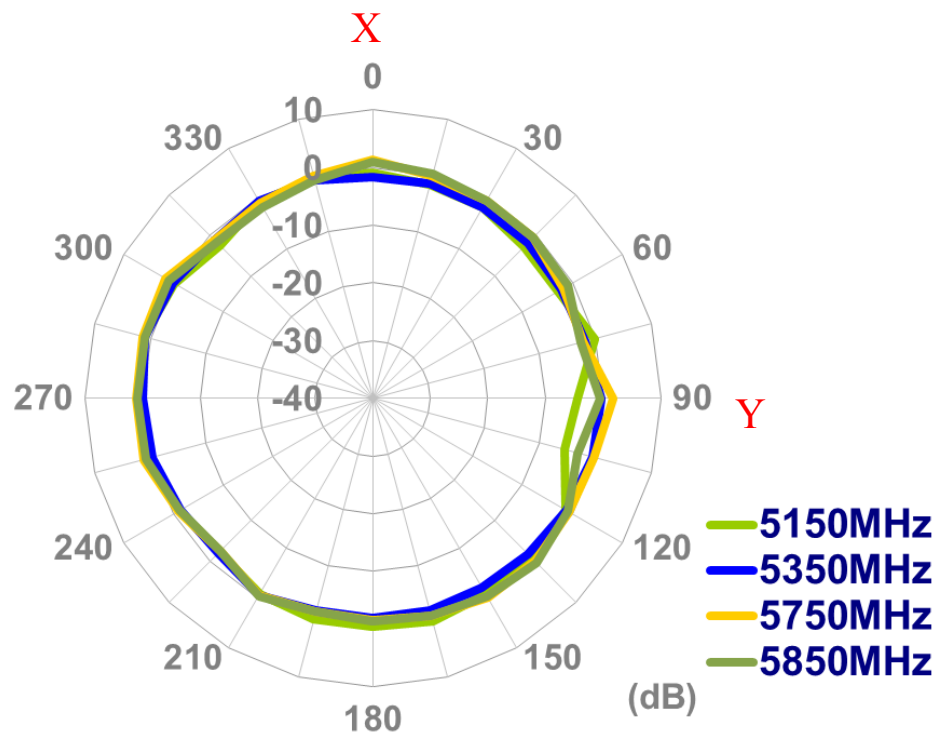

XZ Plane

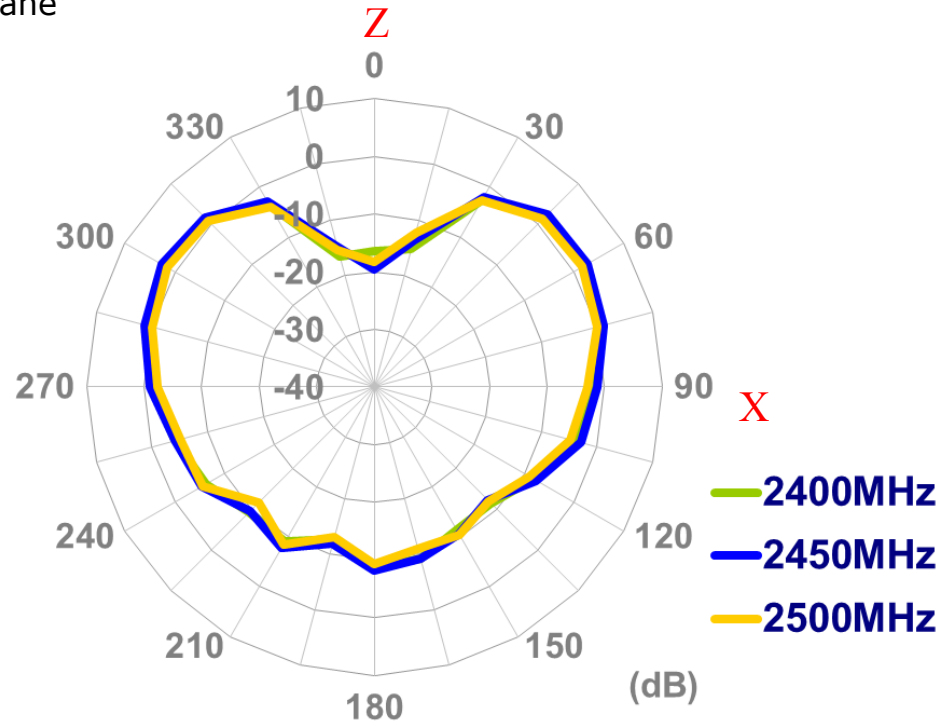

XZ Plane

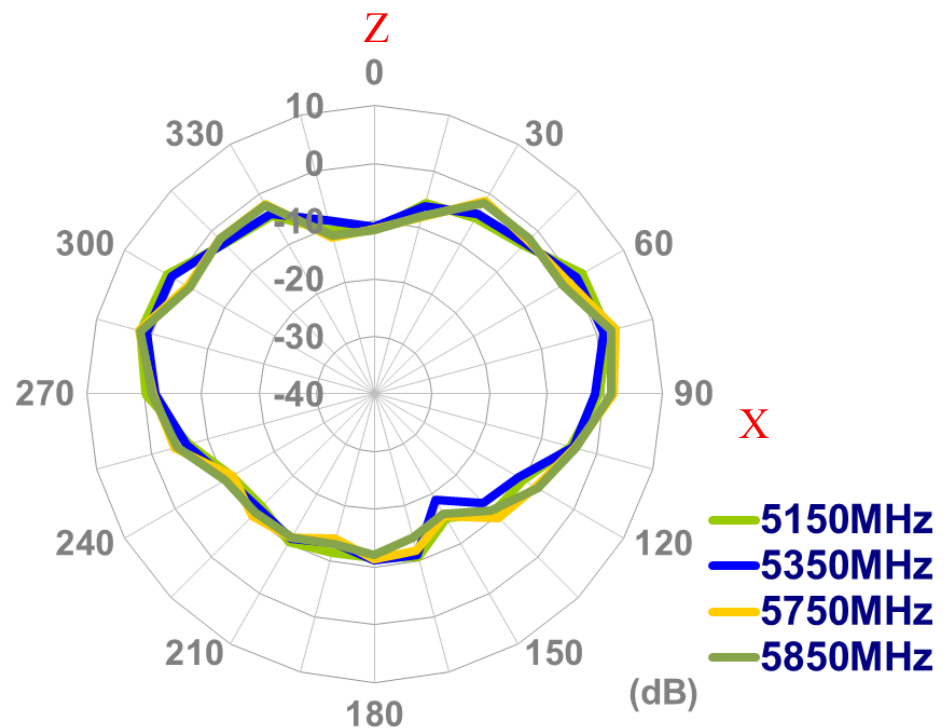

YZ Plane

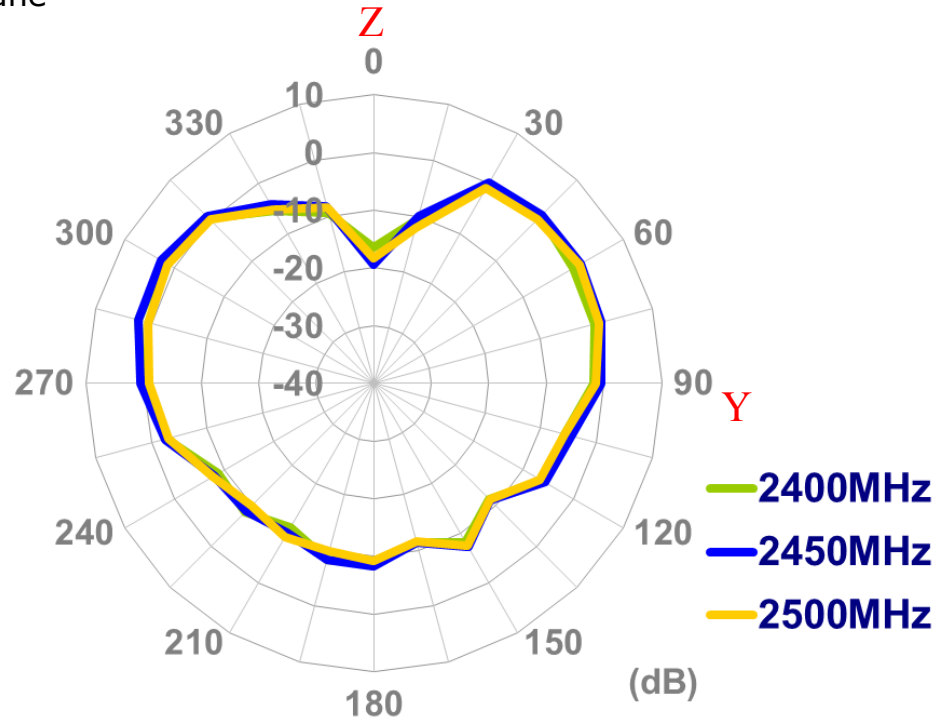

YZ Plane

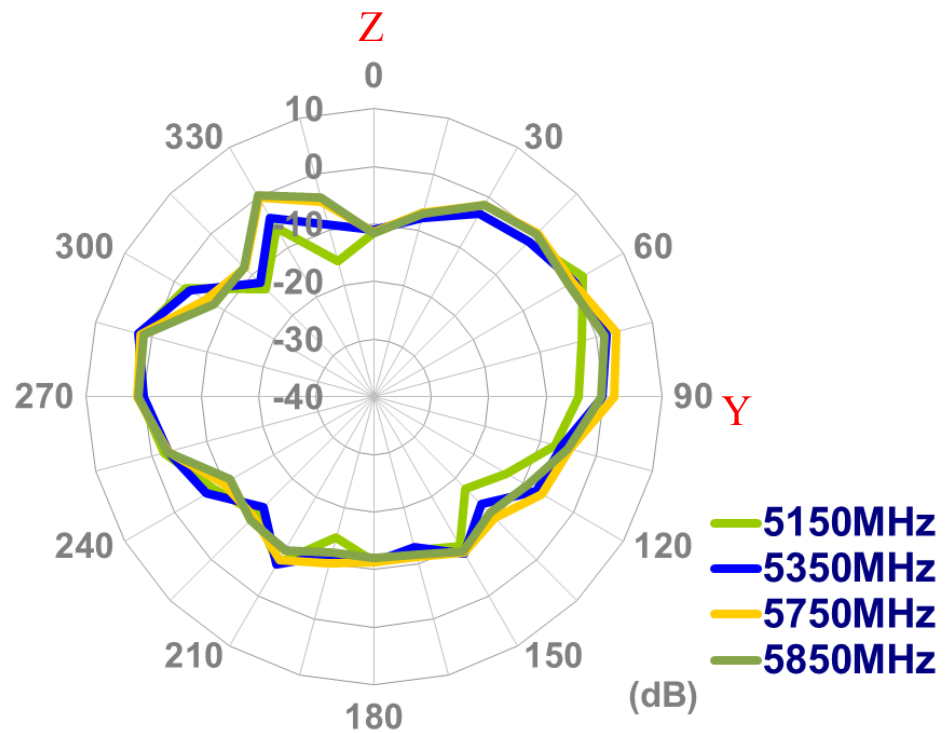

5. Installation

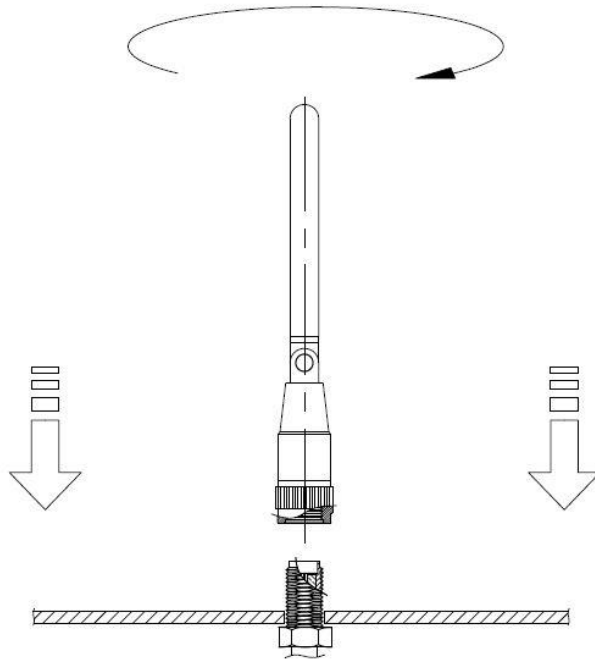

Recommended torque for mounting is 0.9 N.m
Maximum torque for mounting is 1.176 N.m

6. Mechanical Drawing

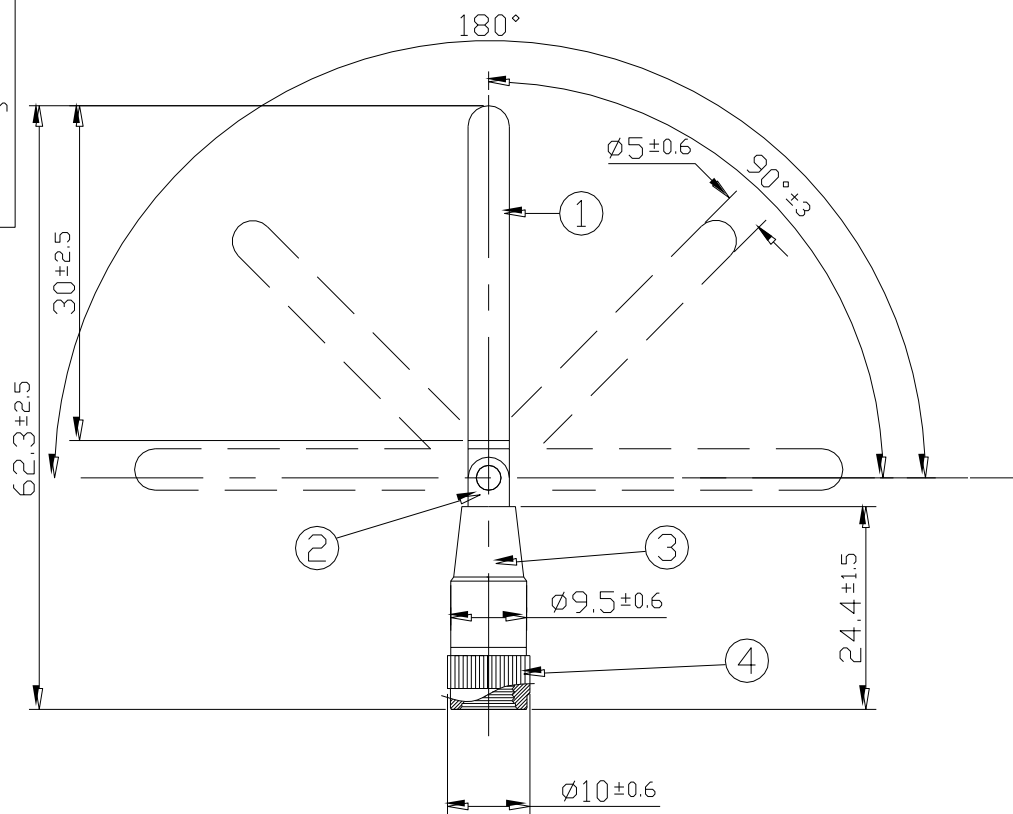
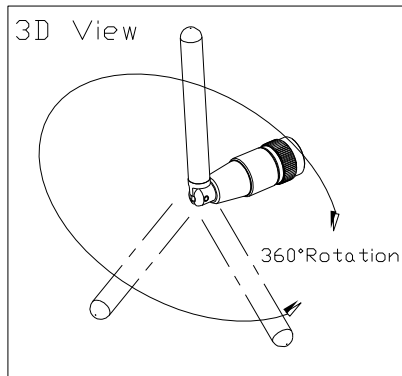

	Name	Material	Finish	QTY
1	Housing	POM	Green	1
2	Hinge	Brass	Ni Plated	1
3	Cap	POM	Green	1
4	SMA(M) RP	Brass	Ni Plated	1

7. Packaging

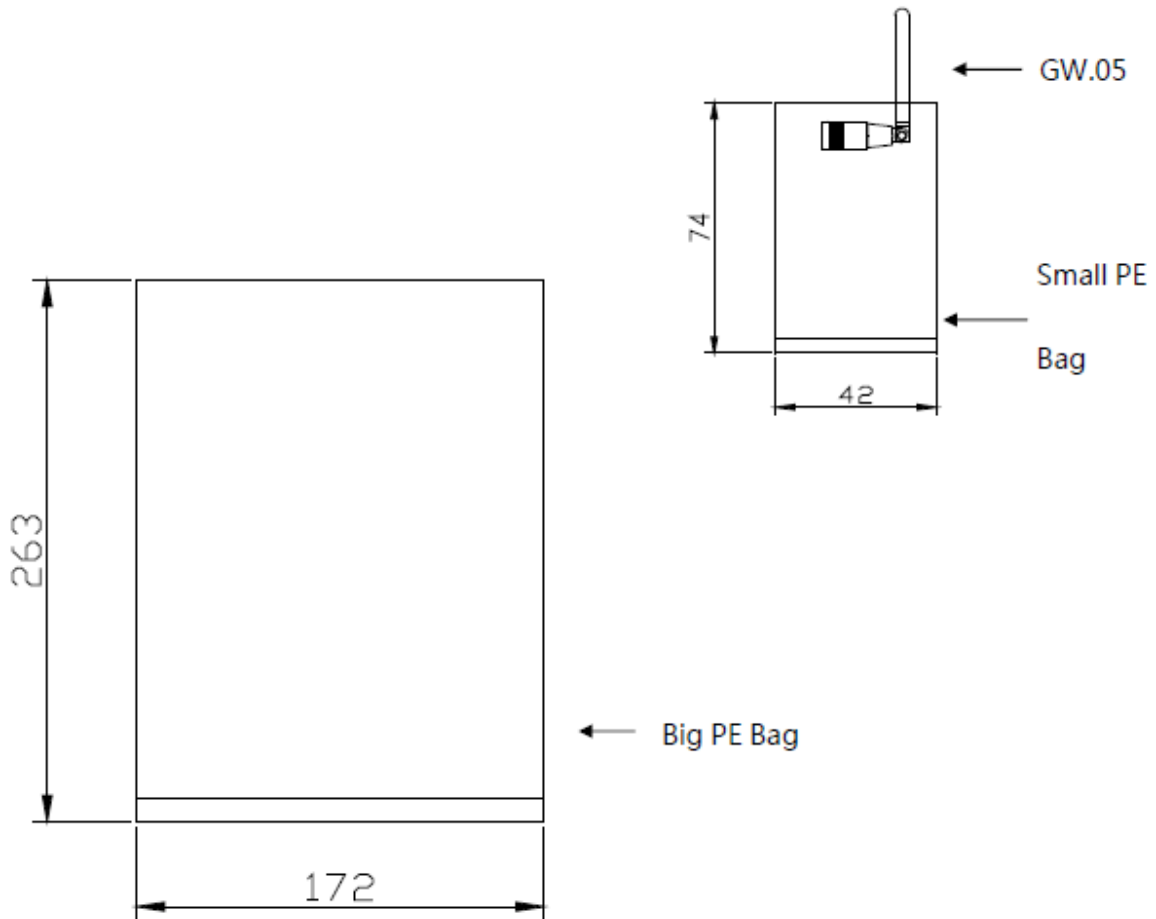

1 piece per small PE Bag, 100 small bags per big PE bag.