

# 大容量積層セラミックコンデンサ HIGH VALUE MULTILAYER CERAMIC CAPACITORS

	code	Temp.characteristics	operating Temp. range
OPERATING TEMP.	BJ	B	-25~+85°C
		X5R	-55~+85°C
	B7	X7R	-55~+125°C
		F	-25~+85°C
	F	Y5V	-30~+85°C



## 特長 FEATURES

- 電極にNi金属を使用し、端子電極部にメッキをしてあることにより、はんだ付け性および耐熱性にすぐれ、マイグレーションもほとんど発生せず、高い信頼性を示します
- 等価直列抵抗 (ESR) が小さく、ノイズ吸収性にすぐれています。
- 特にタンタルおよびアルミ電解コンデンサと比較した場合：
  - 高い許容リップル電流値
  - 高い定格電圧でありながら小型形状
  - 絶縁抵抗、破壊電圧が高く信頼性にすぐれている
  - 等の特徴があります

- The use of Nickel(Ni) as material for both the internal and external electrodes improves the solderability and heat resistance characteristics. This almost completely eliminates migration and raises the level of reliability significantly.
- Low equivalent series resistance(ESR) provides excellent noise absorption characteristics.
- Compared to tantalum or aluminum electrolytic capacitors these ceramic capacitors offer a number of excellent features, including:
  - Higher permissible ripple current values
  - Smaller case sizes relative to rated voltage
  - Improved reliability due to higher insulation resistance and breakdown voltage.

## 用途 APPLICATIONS

- デジタル回路全般
- 電源バイパスコンデンサ
  - 液晶モジュール用
  - 液晶駆動電圧ライン用
  - 電源電圧の高いLSI、IC、OPアンプ用
- 平滑コンデンサ
  - DC-DCコンバータ (入力、出力側用)
  - スイッチング電源 (2次側用)

- General digital circuit
- Power supply bypass capacitors
  - Liquid crystal modules
  - Liquid crystal drive voltage lines
  - LSI, IC, converters(both for input and output)
- Smoothing capacitors
  - DC-DC converters (both for input and output)
  - Switching power supplies (secondary side)

## 形名表記法 ORDERING CODE

<b>1</b> 定格電圧 [VDC]	<b>3</b> 端子電極	<b>5</b> 温度特性 [%]	<b>7</b> 容量許容差	<b>9</b> 個別仕様
A 4 J 6.3 L 10 E 16 T 25 G 35 U 50	K メッキ品	△F ±30/80 BJ B ±10 △=スペース	K ±10 % M ±20 % Z +80/-20 %	- 標準
<b>2</b> シリーズ名	<b>4</b> 形状寸法[EIA] L×W (mm)	<b>6</b> 公称静電容量 [pF]	<b>8</b> 製品厚み [mm]	<b>10</b> 包装
M 積層コンデンサ	107 (0603) 1.6×0.8 212 (0805) 2.0×1.25 316 (1206) 3.2×1.6 325 (1210) 3.2×2.5	例 473 47,000 105 1,000,000	K 0.45 A 0.8 D 0.85 F 1.15 G 1.25 H 1.5 L 1.6 N 1.9 Y 2.0max M 2.5	T リールテーピング
				<b>11</b> 当社管理記号
				△ 標準品 △=スペース

J M K 3 1 6 B J 1 0 6 M L - T ○

<b>1</b> Rated voltage [VDC]	<b>3</b> End termination	<b>5</b> Temperature characteristics code	<b>7</b> Capacitance tolerances [%]	<b>9</b> Special code
A 4 J 6.3 L 10 E 16 T 25 G 35 U 50	K Plated	△F Y5V -30~+85°C +22/-82% B 7 X7R -55~+125°C ±15% B J X5R -55~+85°C ±15% △=Blank space	K ±10 M ±20 Z +80/-20	- Standard products
<b>2</b> Series name	<b>4</b> Dimensions [case size] (mm)	<b>6</b> Nominal capacitance [pF]	<b>8</b> Thickness [mm]	<b>10</b> Packaging
M Multilayer Ceramic Capacitors	107 (0603) 1.6×0.8 212 (0805) 2.0×1.25 316 (1206) 3.2×1.6 325 (1210) 3.2×2.5	example 473 47,000 105 1,000,000	K 0.45 A 0.8 D 0.85 F 1.15 G 1.25 H 1.5 L 1.6 N 1.9 Y 2.0max M 2.5	T Tape & reel
				<b>11</b> Internal code
				△ Standard products △=Blank space

# 外形寸法 EXTERNAL DIMENSIONS

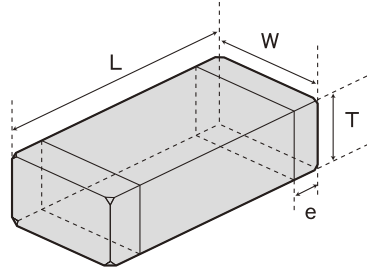

注: \*1. ±0.15mm公差あり  
 \*2. ±0.3mm公差あり  
 \*3. ±0.2mm公差あり  
 \*4. +0.15/-0.1mm公差あり  
 Note: \*1. Including dimension tolerance ±0.15mm (±0.006 inch).  
 Note: \*2. Including dimension tolerance ±0.3mm (±0.012 inch).  
 Note: \*3. Including dimension tolerance ±0.2mm (±0.008 inch).  
 Note: \*4. Including dimension tolerance +0.15/-0.1mm (+0.006/-0.004 inch).

Type (EIA)	L	W	T	e	
□MK107 (0603)	1.6±0.10 <sup>*3,*4</sup> (0.063±0.004)	0.8±0.10 <sup>*3,*4</sup> (0.031±0.004)	0.45±0.05 (0.018±0.002)	K A	0.35±0.25 (0.014±0.010)
			0.8±0.10 <sup>*3,*4</sup> (0.031±0.004)		
□MK212 (0805)	2.0±0.10 <sup>*1,*3</sup> (0.079±0.004)	1.25±0.10 <sup>*1,*3</sup> (0.049±0.004)	0.45±0.05 (0.018±0.002)	K D G	0.5±0.25 (0.020±0.010)
			0.85±0.10 (0.033±0.004)		
			1.25±0.10 <sup>*1,*3</sup> (0.049±0.004)		
□MK316 (1206)	3.2±0.15 <sup>*3</sup> (0.126±0.006)	1.6±0.15 <sup>*3</sup> (0.063±0.006)	0.85±0.10 (0.033±0.004)	D F G L	0.5 <sup>+0.35</sup> <sub>-0.25</sub> (0.020 <sup>+0.014</sup> <sub>-0.014</sub> )
			1.15±0.10 (0.045±0.004)		
			1.25±0.10 (0.049±0.004)		
			1.6±0.20 (0.063±0.008)		
			0.85±0.10 (0.033±0.004)		
□MK325 (1210)	3.2±0.30 (0.126±0.012)	2.5±0.20 <sup>*2</sup> (0.098±0.008)	0.85±0.10 (0.033±0.004)	D F H N Y M	0.6±0.3 (0.024±0.012)
			1.15±0.10 (0.045±0.004)		
			1.5±0.10 (0.059±0.004)		
			1.9±0.20 (0.075±0.008)		
			1.9 <sup>+0.3</sup> <sub>-0.2</sub> (0.075 <sup>+0.004</sup> <sub>-0.004</sub> )		
			2.5±0.20 <sup>*2</sup> (0.098±0.008)		
			2.5±0.20 <sup>*2</sup> (0.098±0.008)		

Unit:mm (inch)

# 概略バリエーション AVAILABLE CAPACITANCE RANGE

Cap	Type	107					212					316					325				
		TC	B/X7R	B/X5R	X5R	F/Y5V	B/X7R	B/X5R	X5R	F/Y5V	B/X7R	B/X5R	X5R	F/Y5V	B/X7R	B/X5R	X5R	F/Y5V			
0.022	223	A																			
0.033	333	A	A																		
0.047	473	A	A																		
0.068	683	A	A																		
0.1	104				A																
0.15	154	A	A																		
0.22	224	A	A		A																
0.33	334	A	A																		
0.47	474	A	A	A																	
0.68	684			A																	
1	105	A	A	A	A																
2.2	225			A	A																
3.3	335			A	A																
4.7	475			A	A																
6.8	685																				
10	106				A																
22	226				A																
47	476																				
100	107																				

注: グラフの記号は製品の厚み記号です。 Note: Letters in the table indicate thickness.

## ■低背積層セラミックコンデンサ Low profile Multilayer Ceramic Capacitors

Cap	Type	107					212					316					325				
		TC	B/X5R	X5R	F/Y5V	B/X7R	B/X5R	X5R	F/Y5V	B/X7R	B/X5R	X5R	F/Y5V	B/X7R	B/X5R	X5R	F/Y5V				
0.022	223																				
0.033	333																				
0.047	473																				
0.068	683																				
0.1	104																				
0.22	224																				
0.33	334																				
0.47	474																				
0.68	684																				
1	105	K	K	K																	
2.2	225																				
3.3	335																				
4.7	475																				
6.8	685																				
10	106																				
22	226																				
47	476																				

注: グラフの記号は製品の厚み記号です。 Note: Letters in the table indicate thickness.

温度特性コード Temp.char.Code	温度特性 Temperature characteristics				静電容量許容差[%] Capacitance tolerance	tanδ[%] Dissipation factor
	準拠規格 Applicable standard	温度範囲[°C] Temperature range	基準温度[°C] Ref. Temp.	静電容量変化率[%] Capacitance change		
BJ	JIS	B	-25~+85	20	±10	±10 (K) ±20 (M)
	EIA	X5R	-55~+85	25	±15	
B7	EIA	X7R	-55~+125	25	±15	+80 -20 (Z)
F	JIS	F	-25~+85	20	+30/-80	
	EIA	Y5V	-30~+85	25	+22/-82	

\*: 代表的な値を記載しています。詳細はアイテム一覧表を参照ください。  
 \*: The figure indicates typical value. Please refer to PART NUMBERS table.

セレクションガイド Selection Guide (P.10) |
 アイテム一覧 Part Numbers (P.44) |
 特性図 Electrical Characteristics (P.52) |
 梱包 Packaging (P.98) |
 信頼性 Reliability Data (P.102) |
 使用上の注意 Precautions (P.108)

107TYPE

【温度特性 Temp.char. BJ:B/X5R】

定格電圧 Rated Voltage	形名 Ordering code	EHS (Environmental Hazardous Substances)	公称 静電容量 Capacitance [μF]	温度特性 Temperature characteristics	tan δ Dissipation factor [%] Max.	実装条件 Soldering method R:リフロー Reflow soldering W: フロー Wave soldering	静電容量 許容差 Capacitance tolerance	厚み Thickness [mm]
35V	GMK107 BJ333□A	RoHS	0.033	B/X5R	3.5	R/W	±10% ±20%	0.8±0.1
	GMK107 BJ473□A	RoHS	0.047	B/X5R	3.5			0.8±0.1
	GMK107 BJ105□A*	RoHS	1	B/X5R	5	R		0.8±0.1
25V	TMK107 BJ223□A	RoHS	0.022	B/X5R**	2.5	R/W		0.8±0.1
	TMK107 BJ683□A	RoHS	0.068	B/X5R	3.5			0.8±0.1
	TMK107 BJ154□A	RoHS	0.15	B/X5R	3.5			0.8±0.1
	TMK107 BJ224□A	RoHS	0.22	B/X5R	3.5			0.8±0.1
	TMK107 BJ334□A	RoHS	0.33	B/X5R	3.5	R		0.8±0.1
	TMK107 BJ474□A*	RoHS	0.47	B/X5R	3.5			0.8±0.1
	TMK107 BJ105□A*	RoHS	1	B/X5R	5			0.8±0.1
16V	EMK107 BJ105□K*	RoHS	1	X5R	10	R/W	0.45±0.05	
	EMK107 BJ333□A	RoHS	0.033	B/X5R**	3.5		0.8±0.1	
	EMK107 BJ473□A	RoHS	0.047	B/X5R**	3.5		0.8±0.1	
	EMK107 BJ683□A	RoHS	0.068	B/X5R**	3.5		0.8±0.1	
	EMK107 BJ154□A*	RoHS	0.15	B/X5R**	3.5	R	0.8±0.1	
	EMK107 BJ224□A*	RoHS	0.22	B/X5R**	3.5		0.8±0.1	
	EMK107 BJ474□A	RoHS	0.47	B/X5R	3.5		0.8±0.1	
	EMK107 BJ105□A*	RoHS	1	B/X5R	5		0.8±0.1	
10V	EMK107 BJ225□A*	RoHS	2.2	B/X5R	10	R/W	0.8±0.1	
	LMK107 BJ105□K*	RoHS	1	B/X5R	10		0.45±0.05	
	LMK107 BJ225□K*	RoHS	2.2	X5R	10	R	0.45±0.05	
	LMK107 BJ334□A	RoHS	0.33	B/X5R**	3.5		0.8±0.1	
	LMK107 BJ474□A	RoHS	0.47	B/X5R**	3.5		0.8±0.1	
	LMK107 BJ684□A	RoHS	0.68	B/X5R	5		0.8±0.1	
	LMK107 BJ105□A*	RoHS	1	B/X5R**	5		0.8±0.1	
	LMK107 BJ225□A*	RoHS	2.2	B/X5R	10		0.8±0.1	
	LMK107 BJ335□A*	RoHS	3.3	X5R	10		0.8±0.1	
	LMK107 BJ475□A*	RoHS	4.7	X5R	10		0.8±0.1	
6.3V	JMK107 BJ474□K	RoHS	0.47	B/X5R	5	R	0.45±0.05	
	JMK107 BJ105□K*	RoHS	1	B/X5R	10		0.45±0.05	
	JMK107 BJ225□K*	RoHS	2.2	X5R	10		0.45±0.05	
	JMK107 BJ475MK*	RoHS	4.7	X5R	10		±20%	0.45±0.05
	JMK107 BJ225□A*	RoHS	2.2	B/X5R	10		±10% ±20%	0.8±0.1
	JMK107 BJ335□A*	RoHS	3.3	X5R	10			0.8±0.1
	JMK107 BJ475□A*	RoHS	4.7	X5R	10			0.8±0.1
4V	JMK107 BJ106MA*	RoHS	10	X5R	10	±20%	0.8+0.15/-0.1	
	AMK107 BJ225□K*	RoHS	2.2	X5R	10	±10% ±20%	0.45±0.05	
	AMK107 BJ475MK*	RoHS	4.7	X5R	10		0.45±0.05	
	AMK107 BJ106MA*	RoHS	10	X5R	10	±20%	0.8±0.1	
	AMK107 BJ226MA*	RoHS	22	X5R	10		0.8±0.2	

\*個別仕様の取交しにより、X7R仕様に対応している場合があります。

We may provide X7R for some items according to the individual specification.

【温度特性 Temp.char. B7:X7R】

定格電圧 Rated Voltage	形名 Ordering code	EHS (Environmental Hazardous Substances)	公称 静電容量 Capacitance [μF]	温度特性 Temperature characteristics	tan δ Dissipation factor [%] Max.	実装条件 Soldering method R:リフロー Reflow soldering W: フロー Wave soldering	静電容量 許容差 Capacitance tolerance	厚み Thickness [mm]
25V	TMK107 B7 223□A	RoHS	0.022	X7R	2.5	R/W	±10% ±20%	0.8±0.1
16V	EMK107 B7 333□A	RoHS	0.033	X7R	3.5			0.8±0.1
	EMK107 B7 473□A	RoHS	0.047	X7R	3.5			0.8±0.1
	EMK107 B7 683□A	RoHS	0.068	X7R	3.5			0.8±0.1
	EMK107 B7 154□A*	RoHS	0.15	X7R	3.5			0.8±0.1
	EMK107 B7 224□A*	RoHS	0.22	X7R	3.5	0.8±0.1		
10V	EMK107 B7 105□A*	RoHS	1	X7R	5	R		0.8±0.1
	LMK107 B7 334□A	RoHS	0.33	X7R	3.5	R/W		0.8±0.1
	LMK107 B7 474□A	RoHS	0.47	X7R	3.5	R		0.8±0.1
	LMK107 B7 105□A*	RoHS	1	X7R	5			0.8±0.1

形名の□には静電容量許容差記号が入ります。 □ Please specify the capacitance tolerance code.

\* 高温負荷試験の試験電圧は定格電圧の1.5倍

\* Test Voltage of Loading at high temperature test is 1.5 time of the rated voltage.

【温度特性 Temp.char. F:F/Y5V】

定格電圧 Rated Voltage	形名 Ordering code		EHS (Environmental Hazardous Substances)	公称 静電容量 Capacitance 〔 $\mu$ F〕	温度特性 Temperature characteristics	$\tan \delta$ Dissipation factor 〔%〕Max.	実装条件 Soldering method R:リフロ- Reflow soldering W: フロ- Wave soldering	静電容量 許容差 Capacitance tolerance	厚み Thickness 〔mm〕
50V	UMK107 F104ZA		RoHS	0.1	F/Y5V	7	R/W	+80% -20%	0.8±0.1
25V	TMK107 F474ZA		RoHS	0.47	F/Y5V	7			0.8±0.1
	EMK107 F224ZA		RoHS	0.22	F/Y5V	7			0.8±0.1
16V	EMK107 F474ZA		RoHS	0.47	F/Y5V	7	R		0.8±0.1
	EMK107 F105ZA		RoHS	1	F/Y5V	16			0.8±0.1
	EMK107 F225ZA		RoHS	2.2	F/Y5V	16			0.8±0.1
10V	LMK107 F105ZA		RoHS	1	F/Y5V	16		0.8±0.1	
	LMK107 F225ZA		RoHS	2.2	F/Y5V	16		0.8±0.1	

■ 212TYPE

【温度特性 Temp.char. BJ:B/X5R】

定格電圧 Rated Voltage	形名 Ordering code	EHS (Environmental Hazardous Substances)	公称 静電容量 [μF]	温度特性 Temperature characteristics	tanδ Dissipation factor [%] Max.	実装条件 Soldering method R:リフロー- Reflow soldering W: 70- Wave soldering	静電容量 許容差 Capacitance tolerance	厚み Thickness [mm]
50V	UMK212 BJ223□D	RoHS	0.022	B/X5R**	2.5	R/W	±10% ±20%	0.85±0.1
	UMK212 BJ333□D	RoHS	0.033	B/X5R**	2.5			0.85±0.1
	UMK212 BJ473□G	RoHS	0.047	B/X5R**	3.5			1.25±0.1
	UMK212 BJ683□G	RoHS	0.068	B/X5R**	3.5			1.25±0.1
	UMK212 BJ104□G	RoHS	0.1	B/X5R**	3.5			1.25±0.1
	UMK212 BJ154□G	RoHS	0.15	B/X5R**	3.5			1.25±0.1
	UMK212 BJ224□G*	RoHS	0.22	B/X5R**	3.5			1.25±0.1
35V	UMK212 BJ474□G*	RoHS	0.47	B/X5R	3.5	1.25±0.1		
	GMK212 BJ334□G	RoHS	0.33	B/X5R**	3.5	1.25±0.1		
	GMK212 BJ474□G	RoHS	0.47	B/X5R	3.5	1.25±0.1		
25V	GMK212 BJ105□G*	RoHS	1	B/X5R**	3.5	1.25±0.1		
	TMK212 BJ473□D	RoHS	0.047	B/X5R**	2.5	R	0.85±0.1	
	TMK212 BJ683□D	RoHS	0.068	B/X5R**	2.5		0.85±0.1	
	TMK212 BJ474□D	RoHS	0.47	B/X5R	3.5		0.85±0.1	
	TMK212 BJ105□D	RoHS	1	B/X5R	5		0.85±0.1	
	TMK212 BJ105□G	RoHS	1	B/X5R	5		1.25±0.1	
	TMK212 BJ225□G*	RoHS	2.2	B/X5R	5		1.25±0.1	
TMK212 BJ475□G*	RoHS	4.7	X5R	10	1.25±0.15			
16V	EMK212 BJ105□K*	RoHS	1	B/X5R	5	R/W	±10% ±20%	0.45±0.05
	EMK212 BJ474□D	RoHS	0.47	B/X5R**	3.5			0.85±0.1
	EMK212 BJ684□D	RoHS	0.68	B/X5R**	3.5			0.85±0.1
	EMK212 BJ105□D	RoHS	1	B/X5R	5	R		0.85±0.1
	EMK212 BJ225□D	RoHS	2.2	B/X5R	5			0.85±0.1
	EMK212 BJ475□D*	RoHS	4.7	B/X5R	10			0.85±0.1
	EMK212 BJ684□G	RoHS	0.68	B/X5R**	3.5	R/W		1.25±0.1
	EMK212 BJ105□G	RoHS	1	B/X5R**	3.5			1.25±0.1
	EMK212 BJ225□G	RoHS	2.2	B/X5R**	5			1.25±0.1
	EMK212 BJ475□G*	RoHS	4.7	B/X5R	5			1.25±0.15
10V	EMK212 BJ106□G*	RoHS	10	B/X5R	10	1.25±0.15		
	LMK212 BJ105□K	RoHS	1	B/X5R	5	R	0.45±0.05	
	LMK212 BJ475□K*	RoHS	4.7	X5R	10		0.45±0.05	
	LMK212 BJ105□D	RoHS	1	B/X5R**	3.5		0.85±0.1	
	LMK212 BJ225□D*	RoHS	2.2	B/X5R	5	0.85±0.1		
	LMK212 BJ475□D*	RoHS	4.7	B/X5R	10	0.85±0.1		
	LMK212 BJ106□D*	RoHS	10	X5R	10	0.85±0.1		
	LMK212 BJ105□G	RoHS	1	B/X5R**	3.5	R/W	1.25±0.1	
	LMK212 BJ225□G	RoHS	2.2	B/X5R**	5	R	1.25±0.1	
	LMK212 BJ335□G	RoHS	3.3	B/X5R**	5		1.25±0.1	
	LMK212 BJ475□G	RoHS	4.7	B/X5R	5		1.25±0.15	
LMK212 BJ106□G	RoHS	10	X5R	10	1.25±0.15			
LMK212 BJ226MG	RoHS	22	X5R	10	±20%		1.25±0.2	
6.3V	JMK212 BJ105□K	RoHS	1	B/X5R	5	R	±10%	0.45±0.05
	JMK212 BJ475□K*	RoHS	4.7	X5R	10		±20%	0.45±0.05
	JMK212 BJ106MK*	RoHS	10	X5R	10		±20%	0.45±0.05
	JMK212 BJ475□D	RoHS	4.7	X5R	10		±10%	0.85±0.1
	JMK212 BJ106□D*	RoHS	10	X5R	10		±20%	0.85±0.1
	JMK212 BJ226MD*	RoHS	22	X5R	10		±20%	0.85±0.1
	JMK212 BJ475□G	RoHS	4.7	B/X5R	5		±10%	1.25±0.15
	JMK212 BJ106□G	RoHS	10	X5R	10		±20%	1.25±0.15
	JMK212 BJ226MG*	RoHS	22	X5R	10		±20%	1.25±0.15
	JMK212 BJ476MG*	RoHS	47	X5R	10		±20%	1.25±0.2
4V	AMK212 BJ226MD*	RoHS	22	X5R	10		0.85±0.1	

形名の□には静電容量許容差記号が入ります。

\* 高温負荷試験の試験電圧は定格電圧の 1.5 倍

\*\* 個別仕様の取交しにより、X7R 仕様に対応している場合があります。

□ Please specify the capacitance tolerance code.

\* Test Voltage of Loading at high temperature test is 1.5 time of the rated voltage.

\*\* We may provide X7R for some items according to the individual specification.

【温度特性 Temp.char. B7:X7R】

定格電圧 Rated Voltage	形名 Ordering code		EHS (Environmental Hazardous Substances)	公称 静電容量 Capacitance 〔μF〕	温度特性 Temperature characteristics	tan δ Dissipation factor 〔%〕Max.	実装条件 Soldering method R:リフロー- Reflow soldering W: 7口- Wave soldering	静電容量 許容差 Capacitance tolerance	厚み Thickness 〔mm〕
50V	UMK212 B7 223□D		RoHS	0.022	X7R	2.5	R/W	±10% ±20%	0.85±0.1
	UMK212 B7 333□D		RoHS	0.033	X7R	2.5			0.85±0.1
	UMK212 B7 473□G		RoHS	0.047	X7R	3.5			1.25±0.1
	UMK212 B7 683□G		RoHS	0.068	X7R	3.5			1.25±0.1
	UMK212 B7 104□G		RoHS	0.1	X7R	3.5			1.25±0.1
	UMK212 B7 154□G		RoHS	0.15	X7R	3.5			1.25±0.1
35V	UMK212 B7 224□G*		RoHS	0.22	X7R	3.5			1.25±0.1
	GМК212 B7 334□G		RoHS	0.33	X7R	3.5			1.25±0.1
25V	GМК212 B7 105□G*		RoHS	1	X7R	3.5			1.25±0.1
	TMK212 B7 473□D		RoHS	0.047	X7R	2.5	R		0.85±0.1
	TMK212 B7 683□D		RoHS	0.068	X7R	2.5			0.85±0.1
16V	TMK212 B7 105□G*		RoHS	1	X7R	5			1.25±0.1
	EMK212 B7 474□D		RoHS	0.47	X7R	3.5	R/W	0.85±0.1	
	EMK212 B7 684□D		RoHS	0.68	X7R	3.5		0.85±0.1	
	EMK212 B7 105□D		RoHS	1	X7R	5	R	0.85±0.1	
	EMK212 B7 684□G		RoHS	0.68	X7R	3.5	R/W	1.25±0.1	
	EMK212 B7 105□G		RoHS	1	X7R	3.5		1.25±0.1	
10V	EMK212 B7 225□G*		RoHS	2.2	X7R	10	R	1.25±0.1	
	LMK212 B7 105□D		RoHS	1	X7R	3.5	R/W	0.85±0.1	
	LMK212 B7 105□G		RoHS	1	X7R	3.5		1.25±0.1	
	LMK212 B7 225□G		RoHS	2.2	X7R	5	R	1.25±0.1	
LMK212 B7 335□G		RoHS	3.3	X7R	5	1.25±0.1			

【温度特性 Temp.char. F:F/Y5V】

定格電圧 Rated Voltage	形名 Ordering code		EHS (Environmental Hazardous Substances)	公称 静電容量 Capacitance 〔μF〕	温度特性 Temperature characteristics	tan δ Dissipation factor 〔%〕Max.	実装条件 Soldering method R:リフロー- Reflow soldering W: 7口- Wave soldering	静電容量 許容差 Capacitance tolerance	厚み Thickness 〔mm〕	
50V	UMK212 F224ZD		RoHS	0.22	F/Y5V	7	R/W	+80% -20%	0.85±0.1	
	UMK212 F474ZG		RoHS	0.47	F/Y5V	7			1.25±0.1	
	UMK212 F105ZG		RoHS	1	F/Y5V	7			1.25±0.1	
16V	EMK212 F225ZG		RoHS	2.2	F/Y5V	7	R		1.25±0.1	
10V	LMK212 F225ZD		RoHS	2.2	F/Y5V	9				0.85±0.1
	LMK212 F475ZG		RoHS	4.7	F/Y5V	9				1.25±0.1
	LMK212 F106ZG		RoHS	10	F/Y5V	16		1.25±0.1		
6.3V	JMK212 F475ZD		RoHS	4.7	F/Y5V	16	R	0.85±0.1		
	JMK212 F106ZG		RoHS	10	F/Y5V	16		1.25±0.1		

形名の□には静電容量許容差記号が入ります。 □ Please specify the capacitance tolerance code.

\* 高温負荷試験の試験電圧は定格電圧の 1.5 倍 \* Test Voltage of Loading at high temperature test is 1.5 time of the rated voltage.



■ 316TYPE

【温度特性 Temp.char. BJ:B/X5R】

定格電圧 Rated Voltage	形名 Ordering code	EHS (Environmental Hazardous Substances)	公称 静電容量 Capacitance [μF]	温度特性 Temperature characteristics	tan δ Dissipation factor [%] Max.	実装条件 Soldering method R:リフロー Reflow soldering W: 70- Wave soldering	静電容量 許容差 Capacitance tolerance	厚み Thickness [mm]	
50V	UMK316 BJ224□L	RoHS	0.22	B/X5R**	2.5	R/W	±10% ±20%	1.6±0.2	
	UMK316 BJ474□L	RoHS	0.47	B/X5R**	3.5			1.6±0.2	
	UMK316 BJ475□L*	RoHS	4.7	X5R	10	R		1.6±0.2	
35V	GMK316 BJ684□L	RoHS	0.68	B/X5R**	3.5	R/W		1.6±0.2	
	GMK316 BJ105□L	RoHS	1	B/X5R**	3.5			1.6±0.2	
25V	TMK316 BJ105□D	RoHS	1	B/X5R	3.5	R		0.85±0.1	
	TMK316 BJ225□D*	RoHS	2.2	B/X5R	3.5			0.85±0.1	
	TMK316 BJ224□F	RoHS	0.22	B/X5R**	2.5	R/W		1.15±0.1	
	TMK316 BJ334□F	RoHS	0.33	B/X5R**	2.5			1.15±0.1	
	TMK316 BJ225□L	RoHS	2.2	B/X5R**	3.5	R		1.6±0.2	
	TMK316 BJ335□L	RoHS	3.3	B/X5R	3.5		1.6±0.2		
	TMK316 BJ475□L*	RoHS	4.7	B/X5R	5		1.6±0.2		
	TMK316 BJ106□L*	RoHS	10	B/X5R	5		1.6±0.2		
EMK316 BJ225□D	RoHS	2.2	B/X5R	3.5	R/W		0.85±0.1		
EMK316 BJ106□D*	RoHS	10	X5R	10			0.85±0.1		
16V	EMK316 BJ684□F	RoHS	0.68	B/X5R**	3.5	R/W	1.15±0.1		
	EMK316 BJ105□F	RoHS	1	B/X5R**	3.5		1.15±0.1		
	EMK316 BJ106□F*	RoHS	10	X5R	10	R	1.15±0.1		
	EMK316 BJ225□L	RoHS	2.2	B/X5R**	3.5		1.6±0.2		
	EMK316 BJ335□L	RoHS	3.3	B/X5R**	3.5	R/W	1.6±0.2		
	EMK316 BJ475□L	RoHS	4.7	B/X5R	5		1.6±0.2		
	EMK316 BJ106□L*	RoHS	10	B/X5R	5		1.6±0.2		
	EMK316 BJ226ML*	RoHS	22	B/X5R	10		±20%	1.6±0.2	
	LMK316 BJ475□D	RoHS	4.7	B/X5R	5		R	±10%	0.85±0.1
	LMK316 BJ106□D	RoHS	10	B/X5R	10			±20%	0.85±0.1
10V	LMK316 BJ226MD*	RoHS	22	X5R	10	R	±20%	0.85±0.1	
	LMK316 BJ335□L	RoHS	3.3	B/X5R**	3.5		±10%	1.6±0.2	
	LMK316 BJ475□L	RoHS	4.7	B/X5R**	5	±10% ±20%	1.6±0.2		
	LMK316 BJ106□L	RoHS	10	B/X5R	5		1.6±0.2		
	LMK316 BJ226ML*	RoHS	22	B/X5R	10	±20%	1.6±0.2		
	LMK316 BJ476ML*	RoHS	47	X5R	10		1.6±0.2		
	6.3V	JMK316 BJ106□D	RoHS	10	B/X5R	10	R	±10% ±20%	0.85±0.1
		JMK316 BJ226MD*	RoHS	22	X5R	10		±20%	0.85±0.1
JMK316 BJ476MD*		RoHS	47	X5R	10	±10% ±20%	1.15±0.1		
JMK316 BJ685□F		RoHS	6.8	B/X5R	10		1.6±0.2		
JMK316 BJ106□L		RoHS	10	B/X5R**	5	±10% ±20%	1.6±0.2		
JMK316 BJ226□L		RoHS	22	X5R	10		1.6±0.2		
JMK316 BJ476ML		RoHS	47	X5R	10	±20%	1.6±0.2		
JMK316 BJ107ML*		RoHS	100	X5R	10		1.6±0.2		
4V	AMK316 BJ107ML*	RoHS	100	X5R	10		1.6±0.2		

\*\* 個別仕様の取交しにより、X7R仕様に対応している場合があります。

\*\*We may provide X7R for some items according to the individual specification

【温度特性 Temp.char. B7:X7R】

定格電圧 Rated Voltage	形名 Ordering code	EHS (Environmental Hazardous Substances)	公称 静電容量 Capacitance [μF]	温度特性 Temperature characteristics	tan δ Dissipation factor [%] Max.	実装条件 Soldering method R:リフロー Reflow soldering W: 70- Wave soldering	静電容量 許容差 Capacitance tolerance	厚み Thickness [mm]	
50V	UMK316 B7 224□L	RoHS	0.22	X7R	2.5	R/W	±10% ±20%	1.6±0.2	
	UMK316 B7 474□L	RoHS	0.47	X7R	3.5			1.6±0.2	
35V	GMK316 B7 684□L	RoHS	0.68	X7R	3.5			R/W	1.6±0.2
	GMK316 B7 105□L	RoHS	1	X7R	3.5				1.6±0.2
25V	TMK316 B7 224□F	RoHS	0.22	X7R	2.5			R	1.15±0.1
	TMK316 B7 334□F	RoHS	0.33	X7R	2.5				1.15±0.1
	TMK316 B7 225□L	RoHS	2.2	X7R	3.5	1.6±0.2			
16V	EMK316 B7 684□F	RoHS	0.68	X7R	3.5	R/W		1.15±0.1	
	EMK316 B7 105□F	RoHS	1	X7R	3.5			1.15±0.1	
	EMK316 B7 225□L	RoHS	2.2	X7R	3.5	R		1.6±0.2	
	EMK316 B7 335□L	RoHS	3.3	X7R	3.5		1.6±0.2		
10V	LMK316 B7 335□L	RoHS	3.3	X7R	3.5	R	1.6±0.2		
	LMK316 B7 475□L	RoHS	4.7	X7R	5		1.6±0.2		
	LMK316 B7 106□L*	RoHS	10	X7R	5		1.6±0.2		
6.3V	JMK316 B7 106□L	RoHS	10	X7R	5		1.6±0.2		

形名の□には静電容量許容差記号が入ります。 □ Please specify the capacitance tolerance code.

\* 高温負荷試験の試験電圧は定格電圧の1.5倍 \* Test Voltage of Loading at high temperature test is 1.5 time of the rated voltage.

【温度特性 Temp.char. F:F/Y5V】

定格電圧 Rated Voltage	形名 Ordering code		EHS (Environmental Hazardous Substances)	公称 静電容量 Capacitance 〔μF〕	温度特性 Temperature characteristics	tan δ Dissipation factor 〔%〕Max.	実装条件 Soldering method R:リフロー- Reflow soldering W: 7口- Wave soldering	静電容量 許容差 Capacitance tolerance	厚み Thickness 〔mm〕
50V	UMK316 F225ZG		RoHS	2.2	F/Y5V	7	R/W	+80% -20%	1.25±0.1
35V	GMK316 F475ZG		RoHS	4.7	F/Y5V	7	R		1.25±0.1
	GMK316 F106ZL		RoHS	10	F/Y5V	9			1.6±0.2
25V	TMK316 F106ZL		RoHS	10	F/Y5V	9			1.6±0.2
16V	EMK316 F106ZL		RoHS	10	F/Y5V	9			1.6±0.2
10V	LMK316 F475ZD		RoHS	4.7	F/Y5V	9			0.85±0.1
	LMK316 F106ZF		RoHS	10	F/Y5V	16			1.15±0.1
	LMK316 F226ZL		RoHS	22	F/Y5V	16			1.6±0.2
6.3V	JMK316 F106ZD		RoHS	10	F/Y5V	16			0.85±0.1

■ 325TYPE

【温度特性 Temp.char. BJ:B/X5R】

定格電圧 Rated Voltage	形名 Ordering code		EHS (Environmental Hazardous Substances)	公称 静電容量 Capacitance 〔μF〕	温度特性 Temperature characteristics	tan δ Dissipation factor 〔%〕Max.	実装条件 Soldering method R:リフロー- Reflow soldering W: 7口- Wave soldering	静電容量 許容差 Capacitance tolerance	厚み Thickness 〔mm〕
50V	UMK325 BJ105□H		RoHS	1	B/X5R**	3.5	R/W	±10% ±20%	1.5±0.1
	UMK325 BJ475MM*		RoHS	4.7	X5R	10	R	±20%	2.5±0.2
	UMK325 BJ106MM*		RoHS	10	X5R	10			2.5±0.2
35V	GMK325 BJ225MN		RoHS	2.2	B/X5R	3.5			1.9±0.2
	GMK325 BJ475MN*		RoHS	4.7	X5R	10			1.9±0.2
	GMK325 BJ106MN*		RoHS	10	B/X5R	5			1.9±0.2
25V	TMK325 BJ106MD*		RoHS	10	B/X5R	5			0.85±0.1
	TMK325 BJ225MH		RoHS	2.2	B/X5R**	3.5			1.5±0.1
	TMK325 BJ335MN		RoHS	3.3	B/X5R**	3.5			1.9±0.2
	TMK325 BJ475MN*		RoHS	4.7	B/X5R**	3.5			1.9±0.2
	TMK325 BJ106MN		RoHS	10	B/X5R	5			1.9±0.2
	TMK325 BJ106MM*		RoHS	10	B/X5R	3.5			2.5±0.2
	EMK325 BJ106MD*		RoHS	10	B/X5R	5			0.85±0.1
16V	EMK325 BJ226MD*		RoHS	22	B/X5R	10			0.85±0.1
	EMK325 BJ475MN		RoHS	4.7	B/X5R**	3.5			1.9±0.2
	EMK325 BJ106MN		RoHS	10	B/X5R	3.5			1.9±0.2
	EMK325 BJ226MM*		RoHS	22	B/X5R	5			2.5±0.2
	EMK325 BJ476MM*		RoHS	47	X5R	10			2.5±0.2
10V	LMK325 BJ335MD		RoHS	3.3	B/X5R	3.5			0.85±0.1
	LMK325 BJ475MD		RoHS	4.7	B/X5R	5			0.85±0.1
	LMK325 BJ106MD*		RoHS	10	B/X5R	5			0.85±0.1
	LMK325 BJ226MY*		RoHS	22	B/X5R	5	1.9+0.1/-0.2		
	LMK325 BJ106MN		RoHS	10	B/X5R**	3.5	1.9±0.2		
	LMK325 BJ226MM		RoHS	22	B/X5R	5	2.5±0.2		
	LMK325 BJ476MM*		RoHS	47	X5R	10	2.5±0.2		
6.3V	LMK325 BJ107MM*		RoHS	100	X5R	10	2.5±0.3		
	JMK325 BJ226MY		RoHS	22	X5R	5	1.9+0.1/-0.2		
	JMK325 BJ107MY*		RoHS	100	X5R	10	1.9+0.1/-0.2		
	JMK325 BJ476MN*		RoHS	47	X5R	10	1.9±0.2		
	JMK325 BJ476MM*		RoHS	47	X5R	10	2.5±0.2		
	JMK325 BJ107MM*		RoHS	100	X5R	10	2.5±0.3		

形名の□には静電容量許容差記号が入ります。

□ Please specify the capacitance tolerance code.

\* 高温負荷試験の試験電圧は定格電圧の 1.5 倍

\* Test Voltage of Loading at high temperature test is 1.5 time of the rated voltage.

\*\* 個別仕様の取交しにより、X7R 仕様に対応している場合があります。

\*\* We may provide X7R for some items according to the individual specification.



【温度特性 Temp.char. B7:X7R】

定格電圧 Rated Voltage	形名 Ordering code		EHS (Environmental Hazardous Substances)	公称 静電容量 Capacitance 〔μF〕	温度特性 Temperature characteristics	tan δ Dissipation factor 〔%〕 Max.	実装条件 Soldering method R:リフロー Reflow soldering W: フロ- Wave soldering	静電容量 許容差 Capacitance tolerance	厚み Thickness 〔mm〕
50V	UMK325 B7105□H		RoHS	1	X7R	3.5	R/W	±10% ±20%	1.5±0.1
25V	TMK325 B7225MH		RoHS	2.2	X7R	3.5	R	±20%	1.5±0.1
	TMK325 B7335MN		RoHS	3.3	X7R	3.5			1.9±0.2
	TMK325 B7475MN*		RoHS	4.7	X7R	3.5			1.9±0.2
	TMK325 B7106MN*		RoHS	10	X7R	5			1.9±0.2
16V	EMK325 B7475MN		RoHS	4.7	X7R	3.5		1.9±0.2	
10V	LMK325 B7106MN		RoHS	10	X7R	3.5		1.9±0.2	

【温度特性 Temp.char. F:F/Y5V】

定格電圧 Rated Voltage	形名 Ordering code		EHS (Environmental Hazardous Substances)	公称 静電容量 Capacitance 〔μF〕	温度特性 Temperature characteristics	tan δ Dissipation factor 〔%〕 Max.	実装条件 Soldering method R:リフロー Reflow soldering W: フロ- Wave soldering	静電容量 許容差 Capacitance tolerance	厚み Thickness 〔mm〕
50V	UMK325 F475ZH		RoHS	4.7	F/Y5V	7	R	+80% -20%	1.5±0.1
35V	GMK325 F106ZH		RoHS	10	F/Y5V	7			1.5±0.1
16V	EMK325 F226ZN		RoHS	22	F/Y5V	16			1.9±0.2
10V	LMK325 F106ZF		RoHS	10	F/Y5V	16			1.15±0.1
	LMK325 F226ZN		RoHS	22	F/Y5V	16			1.9±0.2
6.3V	JMK325 F476ZN		RoHS	47	F/Y5V	16			1.9±0.2

形名の□には静電容量許容差記号が入ります。 □ Please specify the capacitance tolerance code.

\* 高温負荷試験の試験電圧は定格電圧の 1.5 倍 \* Test Voltage of Loading at high temperature test is 1.5 time of the rated voltage.

インピーダンス・ESR—周波数特性例 Example of Impedance ESR vs. Frequency characteristics

・当社積層セラミックコンデンサ例 (Taiyo Yuden multilayer ceramic capacitor)

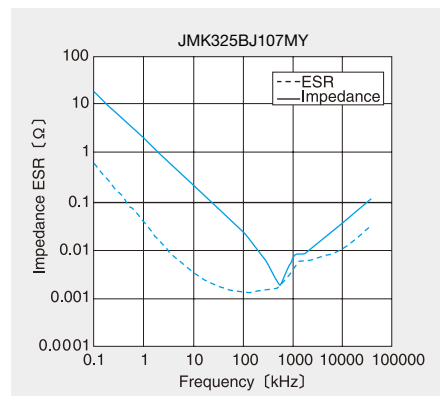
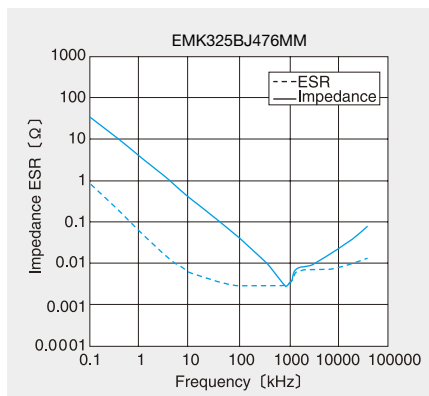
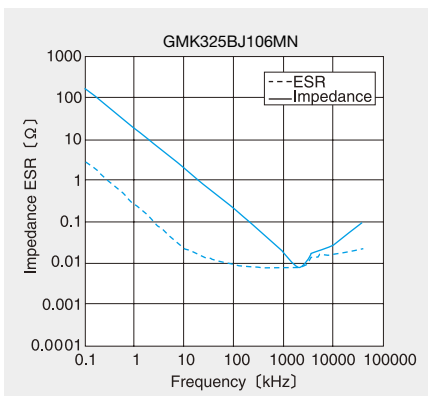
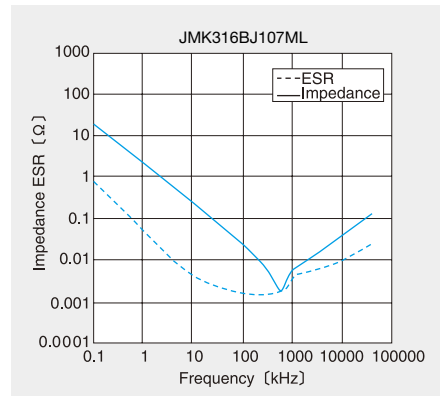
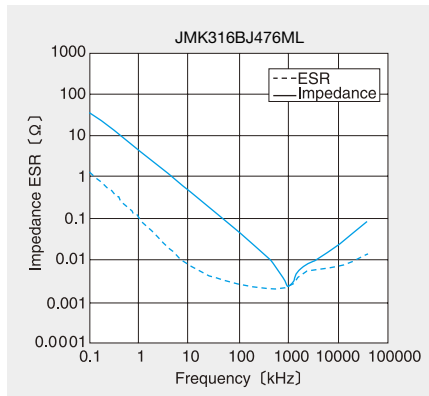
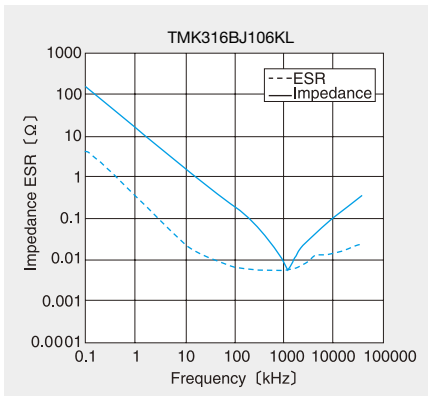
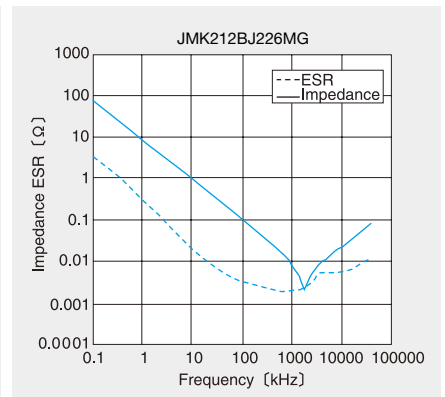
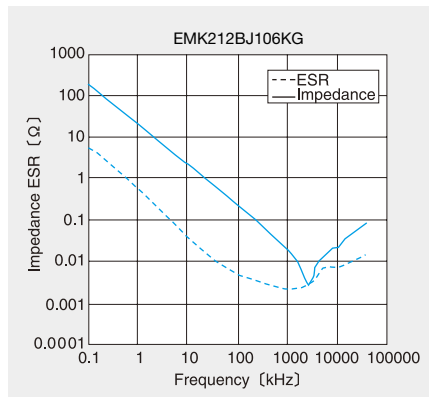
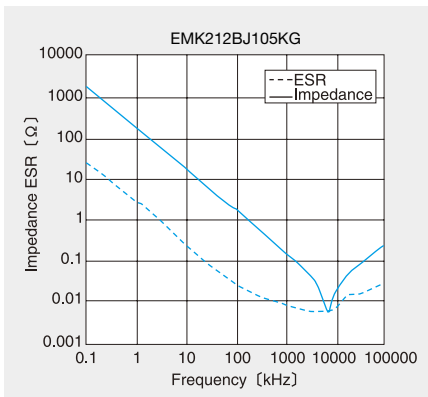
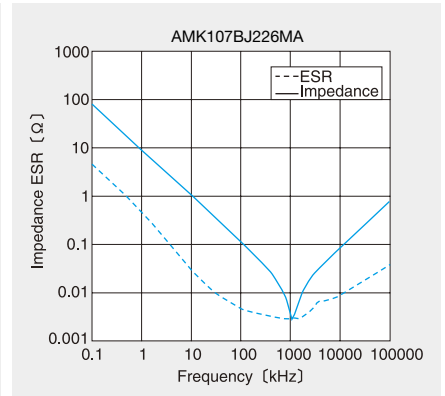
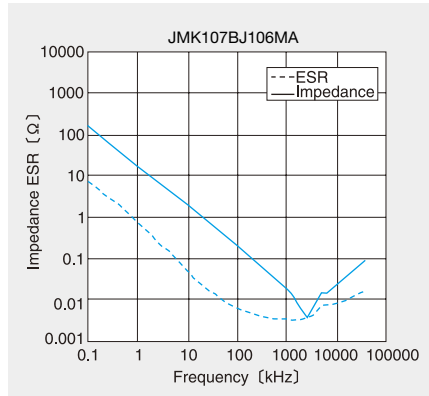
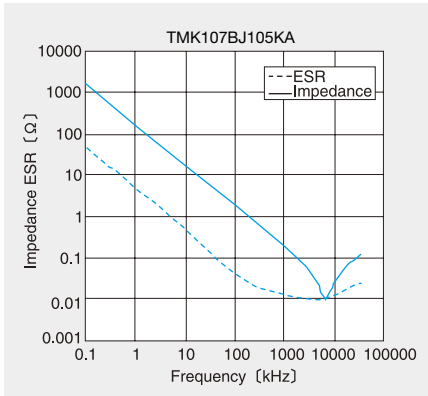

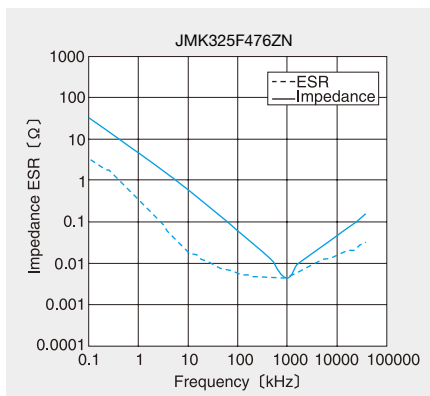
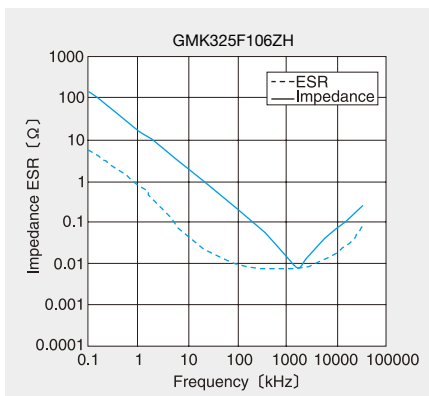
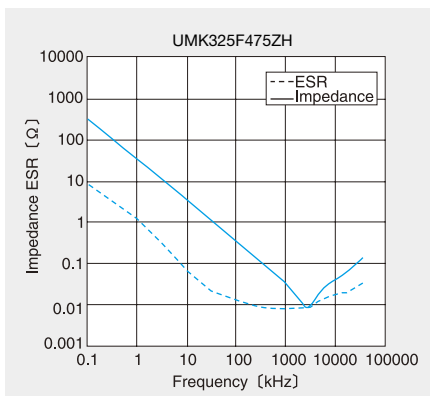
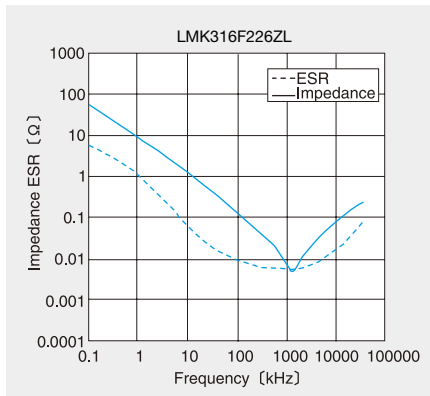
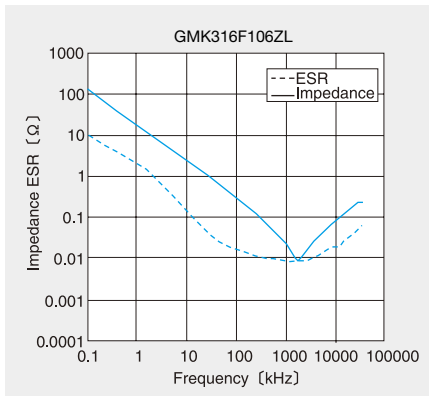
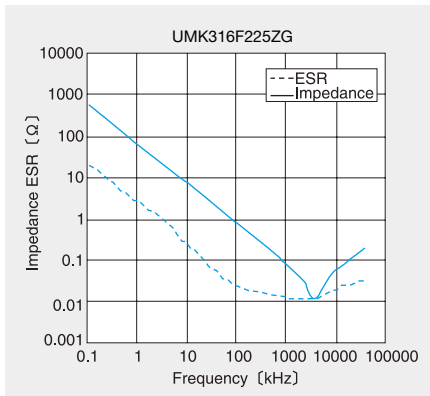
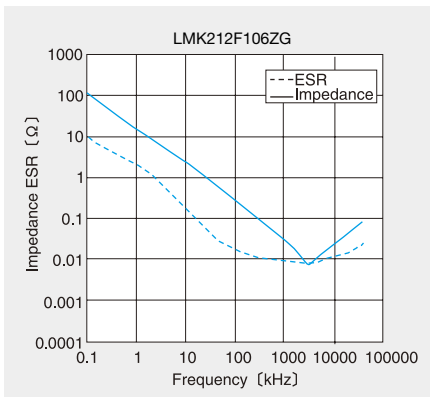
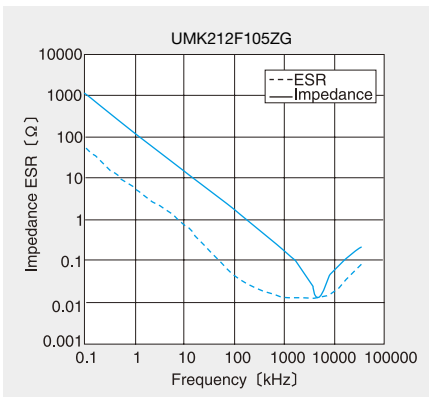
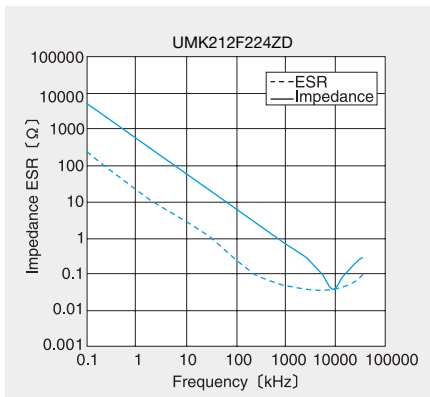
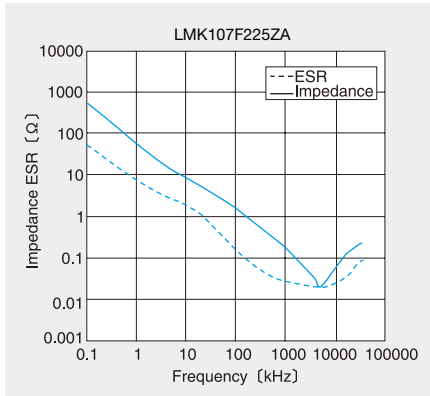
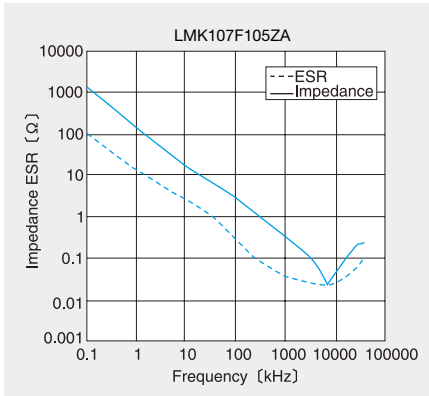
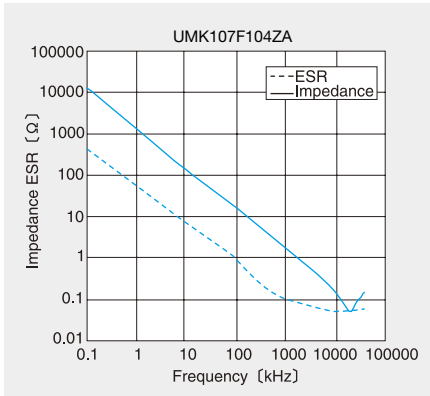

# 梱包 PACKAGING

①最小受注単位数 Minimum Quantity

■テーピング梱包 Taped packaging

形式 (EIA) Type	製品厚み Thickness		標準数量 Standard quantity [ pcs ]	
	mm (inch)	code	紙テープ paper	エンボステープ Embossed tape
□MK042 (01005)	0.2 (0.008)	C	15000	—
□MK063 (0201)	0.3 (0.012)	P	15000	—
□2K096 (0302)	0.3 (0.012)	P	10000	—
	0.45 (0.018)	K		
□WK105 (0204)	0.3 (0.012)	P	10000	—
□MK105 (0402)	0.5 (0.020)	V, W	10000	—
□VK105 (0402)		W		
□MK107 (0603)	0.45 (0.018)	K	4000	—
		V		
□WK107 (0306)	0.5 (0.020)	A	4000	—
		Z		
		V		
□2K110 (0504)	0.5 (0.020)	V	4000	—
	0.8 (0.031)	A	4000	—
□MK212 (0805)	0.6 (0.024)	B	4000	—
		K	4000	—
□WK212 (0508)	0.45 (0.018)	K	4000	—
□4K212 (0805)	0.85 (0.033)	D	4000	—
		G		
□2K212 (0805)	1.25 (0.049)	G	—	3000
□MK316 (1206)	0.85 (0.033)	D	4000	—
		D		
□WK316 (0612)	0.85 (0.033)	F	—	3000
		G		
		L		
□MK325 (1210)	0.85 (0.033)	D	—	2000
	1.15 (0.045)	F		
	1.5 (0.059)	H		
	1.9 (0.075)	N		
	2.0max (0.079)	Y		
□MK432 (1812)	2.5 (0.098)	M	—	500,1000
	2.5 (0.098)	M	—	500

②テーピング材質 Taping material

紙テープ  
Card board carrier tape

※プレスポケットタイプは、  
ボトムテープ無し。

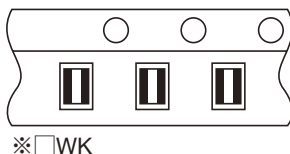
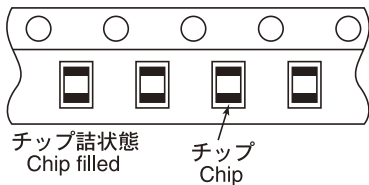
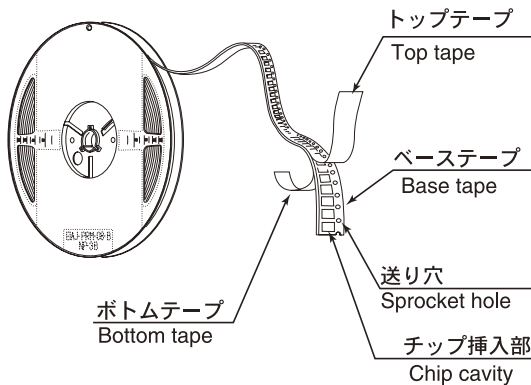

エンボステープ  
Embossed Tape

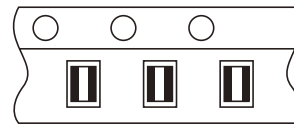
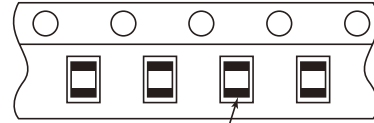
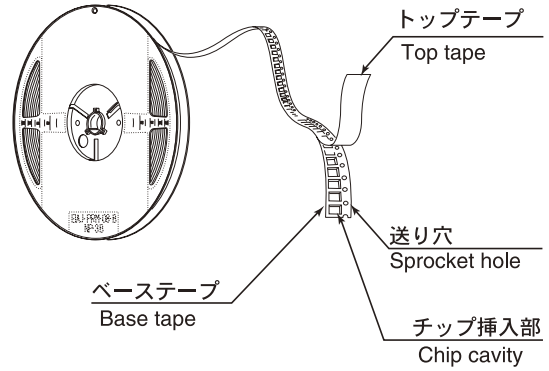

③バルクカセット Bulk Cassette

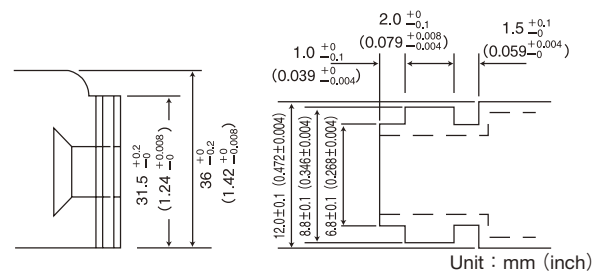
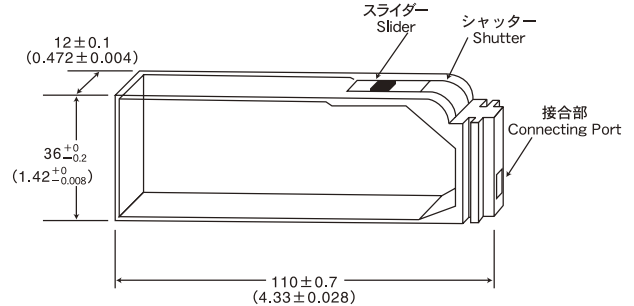

105, 107, 212形状で個別対応致しますのでお問い合わせ下さい。  
Please contact any of our offices for accepting your requirement according to dimensions 0402, 0603, 0805.(inch)

# 梱包 PACKAGING

③テーピング寸法 Taping dimensions  
紙テープ Paper Tape (8mm幅) (0.315inches wide)

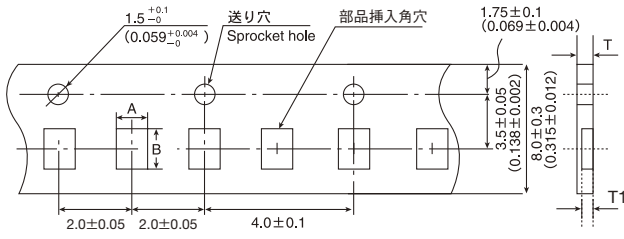

Type (EIA)	チップ挿入部 Chip Cavity		挿入ピッチ Insertion Pitch	テープ厚み Tape Thickness	
	A	B		T	T1
□MK042 (01005)	0.25 (0.010)	0.45 (0.018)	2.0±0.05 (0.079±0.002)	0.36max. (0.014)	0.27max. (0.011)
□MK063 (0201)	0.37 (0.016)	0.67 (0.027)	2.0±0.05 (0.079±0.002)	0.45max. (0.018)	0.42max. (0.017)
□WK105 (0204)	0.65 (0.026)	1.15 (0.045)	2.0±0.05 (0.079±0.002)	0.45max. (0.018max)	0.42max. (0.017max)

Unit : mm (inch)

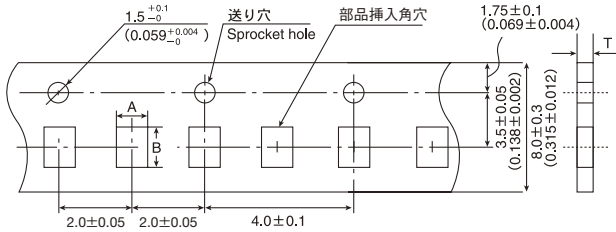

Type (EIA)	チップ挿入部 Chip Cavity		挿入ピッチ Insertion Pitch	テープ厚み Tape Thickness	
	A	B		T	T
□2K096 (0302)	0.72 (0.028)	1.02 (0.040)	2.0±0.05 (0.079±0.002)	0.45max.(0.018max)	0.6max.(0.024max)
□MK105 (0402)	0.65 (0.026)	1.15 (0.045)	2.0±0.05 (0.079±0.002)	0.8max. (0.031max.)	

Unit : mm (inch)

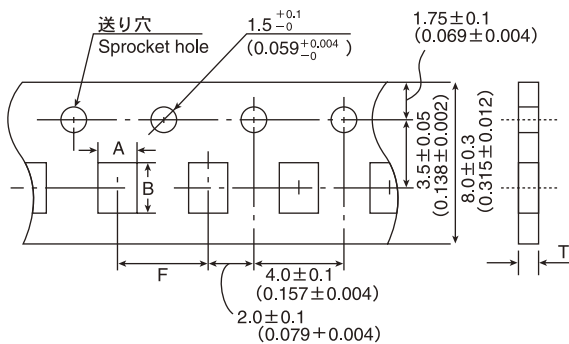

Type (EIA)	チップ挿入部 Chip Cavity		挿入ピッチ Insertion Pitch	テープ厚み Tape Thickness	
	A	B		T	T
□MK107 (0603)	1.0 (0.039)	1.8 (0.071)	4.0±0.1 (0.157±0.004)	1.1max. (0.043max.)	
□WK107 (0306)	1.5 (0.045)	1.55 (0.061)	4.0±0.1 (0.157±0.004)	1.0max. (0.039max.)	
□MK212 (0805)	1.65 (0.065)	2.4 (0.094)	4.0±0.1 (0.157±0.004)	1.1max. (0.043max.)	
□WK212 (0508)				1.1max. (0.043max.)	
□4K212 (0805)	2.0 (0.079)	3.6 (0.142)	4.0±0.1 (0.157±0.004)	1.1max. (0.043max.)	
□2K212 (0805)				1.1max. (0.043max.)	
□MK316 (1206)	2.0 (0.079)	3.6 (0.142)	4.0±0.1 (0.157±0.004)	1.1max. (0.043max.)	
□WK316 (0612)				1.1max. (0.043max.)	

Unit : mm (inch)

エンボステープ Embossed tape (8mm幅) (0.315inches wide)

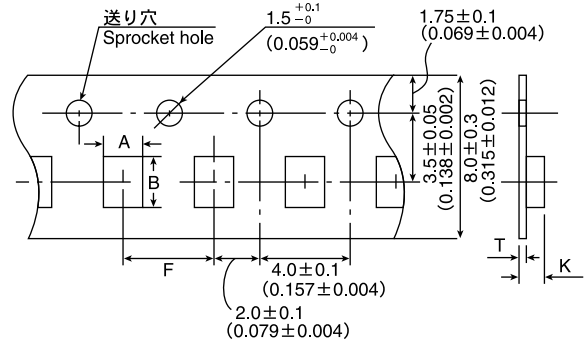

Type (EIA)	チップ挿入部 Chip cavity		挿入ピッチ Insertion Pitch	テープ厚み Tape Thickness	
	A	B		K	T
□WK107 (0306)	1.0 (0.039)	1.8 (0.071)	4.0±0.1 (0.157±0.004)	1.3max. (0.051max.)	0.25±0.1 (0.01±0.004)
□MK212 (0805)	1.65 (0.065)	2.4 (0.094)		3.4max. (0.134max.)	0.6max. (0.024max.)
□MK316 (1206)	2.0 (0.079)	3.6 (0.142)	4.0±0.1 (0.157±0.004)	3.4max. (0.134max.)	0.6max. (0.024max.)
□MK325 (1210)	2.8 (0.110)	3.6 (0.142)		3.4max. (0.134max.)	0.6max. (0.024max.)

Unit : mm (inch)

エンボステープ Embossed tape (12mm幅) (0.472inches wide)

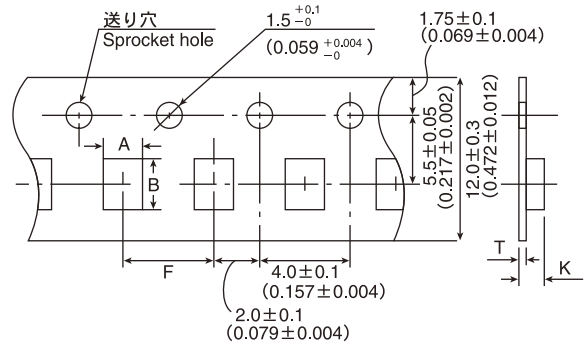

Type (EIA)	チップ挿入部 Chip cavity		挿入ピッチ Insertion Pitch	テープ厚み Tape Thickness	
	A	B		K	T
□MK432 (1812)	3.7 (0.146)	4.9 (0.193)	8.0±0.1 (0.315±0.004)	4.0max. (0.157max.)	0.6max. (0.024max.)

Unit : mm (inch)

④リーダー部／空部 Leader and Blank portion

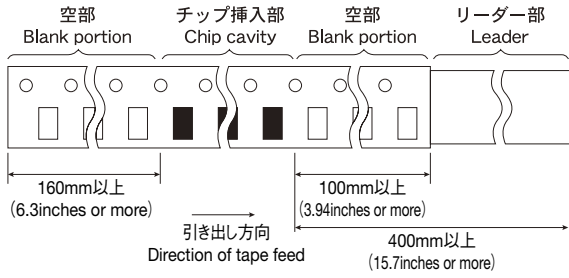

⑤リール寸法 Reel size

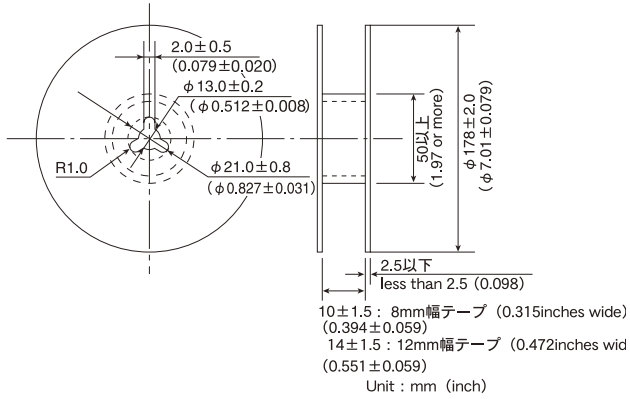

⑥トップテープ強度 Top Tape Strength

トップテープのはがし力は下図矢印方向にて0.1～0.7Nとなります。  
The top tape requires a peel-off force of 0.1～0.7N in the direction of the arrow as illustrated below.

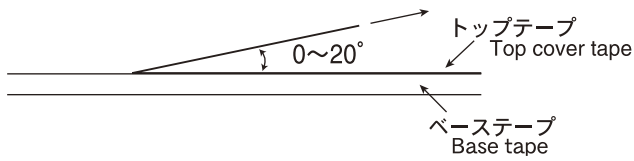

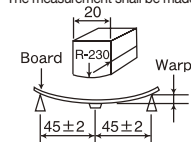

Multilayer Ceramic Capacitor Chips

Item	Specified Value				Test Methods and Remarks
	Temperature Compensating (Class 1)		High Permittivity (Class 2)		
	Standard	High Frequency Type	Standard Note1	High Value	
1. Operating Temperature Range	-55 to +125°C		BJ : -55 to +125°C F : -25 to +85°C	-25 to +85°C	High Capacitance Type BJ (X7R) : -55~+125°C, BJ (X5R) : -55~+85°C E (Y5U) : -30~+85°C, F (Y5V) : -30~+85°C
2. Storage Temperature Range	-55 to +125°C		BJ : -55 to +125°C F : -25 to +85°C	-25 to +85°C	High Capacitance Type BJ (X7R) : -55~+125°C, BJ (X5R) : -55~+85°C E (Y5U) : -30~+85°C, F (Y5V) : -30~+85°C
3. Rated Voltage	50VDC, 25VDC, 16VDC	16VDC 50VDC	50VDC, 25VDC	50VDC, 35VDC, 25VDC 16VDC, 10VDC, 6.3VDC 4DVC, 2.5VDC	
4. Withstanding Voltage Between terminals	No breakdown or damage	No abnormality	No breakdown or damage		Applied voltage: Rated voltage × 3 (Class 1) Rated voltage × 2.5 (Class 2) Duration: 1 to 5 sec. Charge/discharge current: 50mA max. (Class 1,2)
5. Insulation Resistance	10000 MΩ min.		500 MΩ μF, or 10000 MΩ., whichever is the smaller. Note 5		Applied voltage: Rated voltage Duration: 60 ± 5 sec. Charge/discharge current: 50mA max.
6. Capacitance (Tolerance)	0.5 to 5 pF : ± 0.25 pF 1 to 10 pF : ± 0.5 pF 5 to 10 pF : ± 1 pF 11 pF or over : ± 5% ± 10% 105TYPE <sup>△</sup> , S <sup>△</sup> , T <sup>△</sup> , U <sup>△</sup> only 0.5~2pF : ± 0.1pF 2.2~20pF : ± 5%	0.5 to 2 pF : ± 0.1 pF 2.2 to 5.1 pF : ± 5%	BJ : ± 10%, ± 20% F : +80% -20%	BJ : ± 10%, ± 20% F : -20% / +80%	Measuring frequency : Class 1 : 1MHz ± 10% (C ≤ 1000pF) 1 k Hz ± 10% (C > 1000pF) Class 2 : 1 k Hz ± 10% (C ≤ 10 μF) 120Hz ± 10Hz (C > 10 μF) Measuring voltage : Note 4 Class 1 : 0.5~5Vrms (C ≤ 1000pF) 1 ± 0.2Vrms (C > 1000pF) Class 2 : 1 ± 0.2Vrms (C ≤ 10 μF) 0.5 ± 0.1Vrms (C > 10 μF) Bias application: None
7. Q or Tangent of Loss Angle (tan δ)	Under 30 pF : Q ≥ 400 + 20C 30 pF or over : Q ≥ 1000 C = Nominal capacitance	Refer to detailed specification	BJ : 2.5% max. (50V, 25V) F : 5.0% max. (50V, 25V) Note 4	BJ : 2.5% max. F : 7% max. Note 4	Multilayer: Measuring frequency : Class 1 : 1MHz ± 10% (C ≤ 1000pF) 1 k Hz ± 10% (C > 1000pF) Class 2 : 1 k Hz ± 10% (C ≤ 10 μF) 120Hz ± 10Hz (C > 10 μF) Measuring voltage : Note 4 Class 1 : 0.5~5Vrms (C ≤ 1000pF) 1 ± 0.2Vrms (C > 1000pF) Class 2 : 1 ± 0.2Vrms (C ≤ 10 μF) 0.5 ± 0.1Vrms (C > 10 μF) Bias application: None High-Frequency-Multilayer: Measuring frequency: 1GHz Measuring equipment: HP4291A Measuring jig: HP16192A
8. Temperature Characteristic of Capacitance	(Without voltage application) CK : 0 ± 250 CJ : 0 ± 120 CH : 0 ± 60 CG : 0 ± 30 RH : -220 ± 60 SK : -330 ± 250 SJ : -330 ± 120 SH : -330 ± 60 TK : -470 ± 250 TJ : -470 ± 120 UK : -750 ± 250 UJ : -750 ± 120 SL : +350 to -1000 (ppm/°C)	CH : 0 ± 60 RH : -220 ± 60 (ppm/°C)	BJ : ± 10% (-25~85°C) F : +30% (-25~85°C) -80 BJ (X7R) : ± 15% F (Y5V) : +22% -82	BJ : ± 10% (-25~+85°C) F : +30% / -80% (-25~+85°C) BJ (X7R, X5R) : ± 15% F (Y5V) : +22% / -82%	According to JIS C 5102 clause 7.12. Temperature compensating: Measurement of capacitance at 20°C and 85°C shall be made to calculate temperature characteristic by the following equation. $\frac{C_{85} - C_{20}}{C_{20} \times \Delta T} \times 10^6 \text{ (ppm/°C)}$ High permittivity: Change of maximum capacitance deviation in step 1 to 5 Temperature at step 1: +20°C Temperature at step 2: minimum operating temperature Temperature at step 3: +20°C (Reference temperature) Temperature at step 4: maximum operating temperature Temperature at step 5: +20°C Reference temperature for X7R, X5R, Y5U and Y5V shall be +25°C
9. Resistance to Flexure of Substrate	Appearance: No abnormality Capacitance change: Within ± 5% or ± 0.5 pF, whichever is larger.	Appearance: No abnormality Capacitance change: Within ± 0.5 pF	Appearance: No abnormality Capacitance change: BJ : Within ± 12.5% F : Within ± 30%		Warp: 1mm Testing board: glass epoxy-resin substrate Thickness: 1.6mm (063 TYPE : 0.8mm) The measurement shall be made with board in the bent position.  (Unit: mm)

Multilayer Ceramic Capacitor Chips

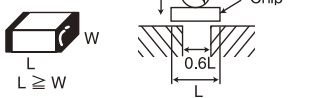
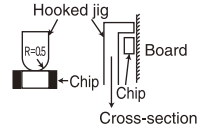
Item	Specified Value				Test Methods and Remarks
	Temperature Compensating (Class 1)		High Permittivity (Class 2)		
	Standard	High Frequency Type	Standard Note1	High Value	
10.Body Strength	—	No mechanical damage.	—	—	High Frequency Multilayer: Applied force: 5N Duration: 10 sec. 
11.Adhesion of Electrode	No separation or indication of separation of electrode.			Applied force: 5N Duration: 30±5 sec. 	
12.Solderability	At least 95% of terminal electrode is covered by new solder.			Solder temperature: 230±5°C Duration: 4±1 sec.	
13.Resistance to soldering	Appearance: No abnormality Capacitance change: Within ±2.5% or ±0.25pF, whichever is larger. Q: Initial value Insulation resistance: Initial value Withstanding voltage (between terminals): No abnormality	Appearance: No abnormality Capacitance change: Within ±2.5% Q: Initial value Insulation resistance: Initial value Withstanding voltage (between terminals): No abnormality	Appearance: No abnormality Capacitance change: Within ±7.5% (BJ) Within ±20% (F) tan δ: Initial value Note 4 Insulation resistance: Initial value Withstanding voltage (between terminals): No abnormality	Preconditioning: Thermal treatment (at 150°C for 1 hr) (Applicable to Class 2.) Solder temperature: 270±5°C Duration: 3±0.5 sec. Preheating conditions: 80 to 100°C, 2 to 5 min. or 5 to 10 min. 150 to 200°C, 2 to 5 min. or 5 to 10 min. Recovery: Recovery for the following period under the standard condition after the test. 6~24 hrs (Class 1) 24±2 hrs (Class 2)	
14.Thermal shock	Appearance: No abnormality Capacitance change: Within ±2.5% or ±0.25pF, whichever is larger. Q: Initial value Insulation resistance: Initial value Withstanding voltage (between terminals): No abnormality	Appearance: No abnormality Capacitance change: Within ±0.25pF Q: Initial value Insulation resistance: Initial value Withstanding voltage (between terminals): No abnormality	Appearance: No abnormality Capacitance change: Within ±7.5% (BJ) Within ±20% (F) tan δ: Initial value Note 4 Insulation resistance: Initial value Withstanding voltage (between terminals): No abnormality	Preconditioning: Thermal treatment (at 150°C for 1 hr) (Applicable to Class 2.) Conditions for 1 cycle: Step 1: Minimum operating temperature $+0_{-3}^{\circ}\text{C}$ 30±3 min. Step 2: Room temperature 2 to 3 min. Step 3: Maximum operating temperature $-0_{+3}^{\circ}\text{C}$ 30±3 min. Step 4: Room temperature 2 to 3 min. Number of cycles: 5 times Recovery after the test: 6~24 hrs (Class 1) 24±2 hrs (Class 2)	
15.Damp Heat (steady state)	Appearance: No abnormality Capacitance change: Within ±5% or ±0.5pF, whichever is larger. Q: $C \geq 30 \text{ pF} : Q \geq 350$ $10 \leq C < 30 \text{ pF} : Q \geq 275 + 2.5C$ $C < 10 \text{ pF} : Q \geq 200 + 10C$ C: Nominal capacitance Insulation resistance: 1000 MΩ min.	Appearance: No abnormality Capacitance change: Within ±0.5pF, Insulation resistance: 1000 MΩ min.	Appearance: No abnormality Capacitance change: BJ: Within ±12.5% F: Within ±30% tan δ: BJ: 5.0% max. F: 7.5% max. Note 4 Insulation resistance: 50 MΩ μF or 1000 MΩ whichever is smaller. Note 5	Appearance: No abnormality Capacitance change: BJ: Within ±12.5% Note 4 tan δ: BJ: 5.0% max. Note 4. F: 11.0% max. Insulation resistance: 50 MΩ μF or 1000 MΩ whichever is smaller. Note 5	Multilayer : Preconditioning: Thermal treatment (at 150°C for 1 hr) (Applicable to Class 2.) Temperature: 40±2°C Humidity: 90 to 95% RH Duration: 500 $+24_{-0}$ hrs Recovery: Recovery for the following period under the standard condition after the removal from test chamber. 6~24 hrs (Class 1) 24±2 hrs (Class 2) High-Frequency Multilayer: Temperature: 60±2°C Humidity: 90 to 95% RH Duration: 500 $+24_{-0}$ hrs Recovery: Recovery for the following period under the standard condition after the removal from test chamber. 6~24 hrs (Class 1)

Multilayer Ceramic Capacitor Chips







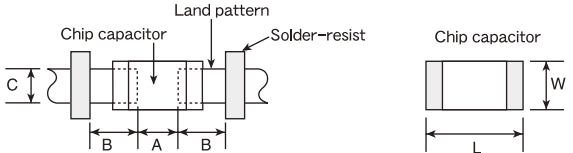
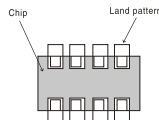



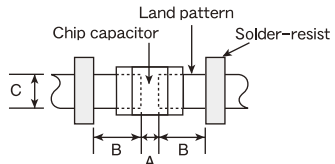
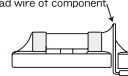

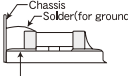
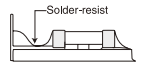
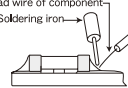
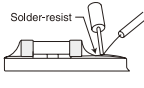
Item	Specified Value				Test Methods and Remarks
	Temperature Compensating (Class 1)		High Permittivity (Class 2)		
	Standard	High Frequency Type	Standard Note1	High Value	
16.Loading under Damp Heat	Appearance: No abnormality Capacitance change: Within $\pm 7.5\%$ or $\pm 0.75\text{pF}$ , whichever is larger. Q: $C \geq 30\text{ pF}$ : $Q \geq 200$ $C < 30\text{ pF}$ : $Q \geq 100 + 10C/3$ C : Nominal capacitance Insulation resistance: 500 M $\Omega$ min.	Appearance: No abnormality Capacitance change: $C \leq 2\text{ pF}$ : Within $\pm 0.4\text{ pF}$ $C > 2\text{ pF}$ : Within $\pm 0.75\text{ pF}$ C : Nominal capacitance Insulation resistance: 500 M $\Omega$ min.	Appearance: No abnormality Capacitance change: BJ: Within $\pm 12.5\%$ F: Within $\pm 30\%$ Note 4 tan $\delta$ : BJ: 5.0% max. F: 7.5% max. Note 4 Insulation resistance: 25 M $\Omega$ $\mu\text{F}$ or 500 M $\Omega$ , whichever is the smaller. Note 5	Appearance: No abnormality Capacitance change: BJ : Within $\pm 12.5\%$ F : Within $\pm 30\%$ Note 4 tan $\delta$ : BJ : 5.0% max. F : 11% max. Note 4 Insulation resistance: 25 M $\Omega$ $\mu\text{F}$ or 500 M $\Omega$ , whichever is the smaller. Note 5	According to JIS C 5102 Clause 9. 9. Multilayer: Preconditioning: Voltage treatment (Class 2) Temperature: $40 \pm 2^\circ\text{C}$ Humidity: 90 to 95% RH Duration: $500^{+24}_0$ hrs Applied voltage: Rated voltage Charge and discharge current: 50mA max. (Class 1,2) Recovery: Recovery for the following period under the standard condition after the removal from test chamber. 6~24 hrs (Class 1) 24 $\pm 2$ hrs (Class 2) High-Frequency Multilayer: Temperature: $60 \pm 2^\circ\text{C}$ Humidity: 90 to 95% RH Duration: $500^{+24}_0$ hrs Applied voltage: Rated voltage Charge and discharge current: 50mA max. Recovery: 6~24 hrs of recovery under the standard condition after the removal from test chamber.
17.Loading at High Temperature	Appearance: No abnormality Capacitance change: Within $\pm 3\%$ or $\pm 0.3\text{pF}$ , whichever is larger. Q: $C \geq 30\text{ pF}$ : $Q \geq 350$ $10 \leq C < 30\text{ pF}$ : $Q \geq 275 + 2.5C$ $C < 10\text{ pF}$ : $Q \geq 200 + 10C$ C : Nominal capacitance Insulation resistance: 1000 M $\Omega$ min.	Appearance: No abnormality Capacitance change: Within $\pm 3\%$ or $\pm 0.3\text{pF}$ , whichever is larger. Insulation resistance: 1000 M $\Omega$ min.	Appearance: No abnormality Capacitance change: BJ: Within $\pm 12.5\%$ F: Within $\pm 30\%$ Note 4 tan $\delta$ : BJ: 4.0% max. F: 7.5% max. Note 4 Insulation resistance: 50 M $\Omega$ $\mu\text{F}$ or 1000 M $\Omega$ , whichever is smaller. Note 5	Appearance: No abnormality Capacitance change: BJ : Within $\pm 12.5\%$ Within $\pm 20\% \ast \ast$ Within $\pm 25\% \ast \ast$ F : Within $\pm 30\%$ Note 4 tan $\delta$ : BJ : 5.0% max. F : 11% max. Note 4 Insulation resistance: 50 M $\Omega$ $\mu\text{F}$ or 1000 M $\Omega$ , whichever is smaller. Note 5	According to JIS C 5102 clause 9.10. Multilayer: Preconditioning: Voltage treatment (Class 2) Temperature: $125 \pm 3^\circ\text{C}$ (Class 1, Class 2: B, BJ (X7R)) $85 \pm 2^\circ\text{C}$ (Class 2: BJ,F) Duration: $1000^{+48}_0$ hrs Applied voltage: Rated voltage $\times 2$ Note 6 Recovery: Recovery for the following period under the standard condition after the removal from test chamber. 6~24 hrs (Class 1) 24 $\pm 2$ hrs (Class 2) High-Frequency Multilayer: Temperature: $125 \pm 3^\circ\text{C}$ (Class 1) Duration: $1000^{+48}_0$ hrs Applied voltage: Rated voltage $\times 2$ Recovery: 6~24 hrs of recovery under the standard condition after the removal from test chamber.

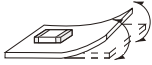
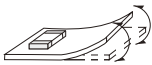
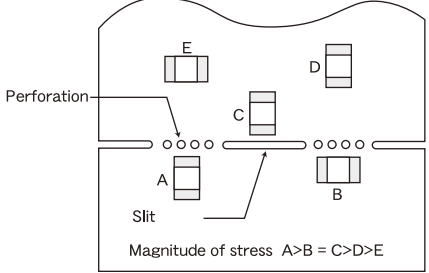
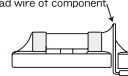
Note 1 :For 105 type, specified in "High value".  
 Note 2 :Thermal treatment (Multilayer): 1 hr of thermal treatment at  $150 \pm 0 / -10^\circ\text{C}$  followed by  $24 \pm 2$  hrs of recovery under the standard condition shall be performed before the measurement.  
 Note 3 :Voltage treatment (Multilayer): 1 hr of voltage treatment under the specified temperature and voltage for testing followed by  $24 \pm 2$  hrs of recovery under the standard condition shall be performed before the measurement.  
 Note 4, 5 :The figure indicates typical inspection. Please refer to individual specifications.  
 Note 6 :Some of the parts are applicable in rated voltage  $\times 1.5$ . Please refer to individual specifications.  
 Note on standard condition: "standard condition" referred to herein is defined as follows: 5 to  $35^\circ\text{C}$  of temperature, 45 to 85% relative humidity, and 86 to 106kPa of air pressure.  
 When there are questions concerning measurement results: In order to provide correlation data, the test shall be conducted under condition of  $20 \pm 2^\circ\text{C}$  of temperature, 60 to 70% relative humidity, and 86 to 106kPa of air pressure. Unless otherwise specified, all the tests are conducted under the "standard condition."

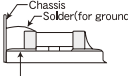
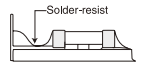
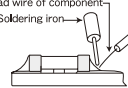
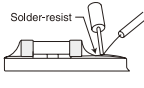
Precautions on the use of Multilayer Ceramic Capacitors

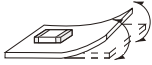
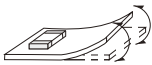
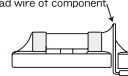
Stages	Precautions	Technical considerations																																																																																																																																		
1.Circuit Design	<p>Verification of operating environment, electrical rating and performance</p> <p>1. A malfunction in medical equipment, spacecraft, nuclear reactors, etc. may cause serious harm to human life or have severe social ramifications. As such, any capacitors to be used in such equipment may require higher safety and/or reliability considerations and should be clearly differentiated from components used in general purpose applications.</p> <p>Operating Voltage (Verification of Rated voltage)</p> <p>1. The operating voltage for capacitors must always be lower than their rated values.</p> <p>If an AC voltage is loaded on a DC voltage, the sum of the two peak voltages should be lower than the rated value of the capacitor chosen. For a circuit where both an AC and a pulse voltage may be present, the sum of their peak voltages should also be lower than the capacitor's rated voltage.</p> <p>2. Even if the applied voltage is lower than the rated value, the reliability of capacitors might be reduced if either a high frequency AC voltage or a pulse voltage having rapid rise time is present in the circuit.</p>																																																																																																																																			
2.PCB Design	<p>Pattern configurations (Design of Land-patterns)</p> <p>1. When capacitors are mounted on a PCB, the amount of solder used (size of fillet) can directly affect capacitor performance. Therefore, the following items must be carefully considered in the design of solder land patterns:</p> <p>(1) The amount of solder applied can affect the ability of chips to withstand mechanical stresses which may lead to breaking or cracking. Therefore, when designing land-patterns it is necessary to consider the appropriate size and configuration of the solder pads which in turn determines the amount of solder necessary to form the fillets.</p> <p>(2) When more than one part is jointly soldered onto the same land or pad, the pad must be designed so that each component's soldering point is separated by solder-resist.</p>	<p>1.The following diagrams and tables show some examples of recommended patterns to prevent excessive solder amounts. (larger fillets which extend above the component end terminations)</p> <p>Examples of improper pattern designs are also shown.</p> <p>(1) Recommended land dimensions for a typical chip capacitor land patterns for PCBs</p>  <p>Recommended land dimensions for wave-soldering (unit: mm)</p> <table border="1" data-bbox="849 1255 1228 1430"> <thead> <tr> <th>Type</th> <th>107</th> <th>212</th> <th>316</th> <th>325</th> </tr> </thead> <tbody> <tr> <td rowspan="2">Size</td> <td>L</td> <td>1.6</td> <td>2.0</td> <td>3.2</td> <td>3.2</td> </tr> <tr> <td>W</td> <td>0.8</td> <td>1.25</td> <td>1.6</td> <td>2.5</td> </tr> <tr> <td>A</td> <td>0.8~1.0</td> <td>1.0~1.4</td> <td>1.8~2.5</td> <td>1.8~2.5</td> </tr> <tr> <td>B</td> <td>0.5~0.8</td> <td>0.8~1.5</td> <td>0.8~1.7</td> <td>0.8~1.7</td> </tr> <tr> <td>C</td> <td>0.6~0.8</td> <td>0.9~1.2</td> <td>1.2~1.6</td> <td>1.8~2.5</td> </tr> </tbody> </table> <p>Recommended land dimensions for reflow-soldering (unit: mm)</p> <table border="1" data-bbox="849 1496 1452 1681"> <thead> <tr> <th>Type</th> <th>042</th> <th>063</th> <th>105</th> <th>107</th> <th>212</th> <th>316</th> <th>325</th> <th>432</th> </tr> </thead> <tbody> <tr> <td rowspan="2">Size</td> <td>L</td> <td>0.4</td> <td>0.6</td> <td>1.0</td> <td>1.6</td> <td>2.0</td> <td>3.2</td> <td>3.2</td> <td>4.5</td> </tr> <tr> <td>W</td> <td>0.2</td> <td>0.3</td> <td>0.5</td> <td>0.8</td> <td>1.25</td> <td>1.6</td> <td>2.5</td> <td>3.2</td> </tr> <tr> <td>A</td> <td>0.15~0.25</td> <td>0.20~0.30</td> <td>0.45~0.55</td> <td>0.8~1.0</td> <td>0.8~1.2</td> <td>1.8~2.5</td> <td>1.8~2.5</td> <td>2.5~3.5</td> </tr> <tr> <td>B</td> <td>0.10~0.20</td> <td>0.20~0.30</td> <td>0.40~0.50</td> <td>0.6~0.8</td> <td>0.8~1.2</td> <td>1.0~1.5</td> <td>1.0~1.5</td> <td>1.5~1.8</td> </tr> <tr> <td>C</td> <td>0.15~0.30</td> <td>0.25~0.40</td> <td>0.45~0.55</td> <td>0.6~0.8</td> <td>0.9~1.6</td> <td>1.2~2.0</td> <td>1.8~3.2</td> <td>2.3~3.5</td> </tr> </tbody> </table> <p>Excess solder can affect the ability of chips to withstand mechanical stresses. Therefore, please take proper precautions when designing land-patterns.</p> <table border="1" data-bbox="849 1747 997 1921"> <thead> <tr> <th>Type</th> <th>212 (4 circuits)</th> </tr> </thead> <tbody> <tr> <td rowspan="2">Size</td> <td>L</td> <td>2.0</td> </tr> <tr> <td>W</td> <td>1.25</td> </tr> <tr> <td>a</td> <td>0.5~0.6</td> </tr> <tr> <td>b</td> <td>0.5~0.6</td> </tr> <tr> <td>c</td> <td>0.2~0.3</td> </tr> <tr> <td>d</td> <td>0.5</td> </tr> </tbody> </table> <table border="1" data-bbox="849 1932 1181 2107"> <thead> <tr> <th>Type</th> <th>212 (2 circuits)</th> <th>110 (2 circuits)</th> <th>096 (2 circuits)</th> </tr> </thead> <tbody> <tr> <td rowspan="2">Size</td> <td>L</td> <td>2.0</td> <td>1.37</td> <td>0.9</td> </tr> <tr> <td>W</td> <td>1.25</td> <td>1.0</td> <td>0.6</td> </tr> <tr> <td>a</td> <td>0.5~0.6</td> <td>0.35~0.45</td> <td>0.25~0.35</td> </tr> <tr> <td>b</td> <td>0.5~0.6</td> <td>0.55~0.65</td> <td>0.15~0.25</td> </tr> <tr> <td>c</td> <td>0.5~0.6</td> <td>0.3~0.4</td> <td>0.15~0.25</td> </tr> <tr> <td>d</td> <td>1.0</td> <td>0.64</td> <td>0.45</td> </tr> </tbody> </table> 	Type	107	212	316	325	Size	L	1.6	2.0	3.2	3.2	W	0.8	1.25	1.6	2.5	A	0.8~1.0	1.0~1.4	1.8~2.5	1.8~2.5	B	0.5~0.8	0.8~1.5	0.8~1.7	0.8~1.7	C	0.6~0.8	0.9~1.2	1.2~1.6	1.8~2.5	Type	042	063	105	107	212	316	325	432	Size	L	0.4	0.6	1.0	1.6	2.0	3.2	3.2	4.5	W	0.2	0.3	0.5	0.8	1.25	1.6	2.5	3.2	A	0.15~0.25	0.20~0.30	0.45~0.55	0.8~1.0	0.8~1.2	1.8~2.5	1.8~2.5	2.5~3.5	B	0.10~0.20	0.20~0.30	0.40~0.50	0.6~0.8	0.8~1.2	1.0~1.5	1.0~1.5	1.5~1.8	C	0.15~0.30	0.25~0.40	0.45~0.55	0.6~0.8	0.9~1.6	1.2~2.0	1.8~3.2	2.3~3.5	Type	212 (4 circuits)	Size	L	2.0	W	1.25	a	0.5~0.6	b	0.5~0.6	c	0.2~0.3	d	0.5	Type	212 (2 circuits)	110 (2 circuits)	096 (2 circuits)	Size	L	2.0	1.37	0.9	W	1.25	1.0	0.6	a	0.5~0.6	0.35~0.45	0.25~0.35	b	0.5~0.6	0.55~0.65	0.15~0.25	c	0.5~0.6	0.3~0.4	0.15~0.25	d	1.0	0.64	0.45
Type	107	212	316	325																																																																																																																																
Size	L	1.6	2.0	3.2	3.2																																																																																																																															
	W	0.8	1.25	1.6	2.5																																																																																																																															
A	0.8~1.0	1.0~1.4	1.8~2.5	1.8~2.5																																																																																																																																
B	0.5~0.8	0.8~1.5	0.8~1.7	0.8~1.7																																																																																																																																
C	0.6~0.8	0.9~1.2	1.2~1.6	1.8~2.5																																																																																																																																
Type	042	063	105	107	212	316	325	432																																																																																																																												
Size	L	0.4	0.6	1.0	1.6	2.0	3.2	3.2	4.5																																																																																																																											
	W	0.2	0.3	0.5	0.8	1.25	1.6	2.5	3.2																																																																																																																											
A	0.15~0.25	0.20~0.30	0.45~0.55	0.8~1.0	0.8~1.2	1.8~2.5	1.8~2.5	2.5~3.5																																																																																																																												
B	0.10~0.20	0.20~0.30	0.40~0.50	0.6~0.8	0.8~1.2	1.0~1.5	1.0~1.5	1.5~1.8																																																																																																																												
C	0.15~0.30	0.25~0.40	0.45~0.55	0.6~0.8	0.9~1.6	1.2~2.0	1.8~3.2	2.3~3.5																																																																																																																												
Type	212 (4 circuits)																																																																																																																																			
Size	L	2.0																																																																																																																																		
	W	1.25																																																																																																																																		
a	0.5~0.6																																																																																																																																			
b	0.5~0.6																																																																																																																																			
c	0.2~0.3																																																																																																																																			
d	0.5																																																																																																																																			
Type	212 (2 circuits)	110 (2 circuits)	096 (2 circuits)																																																																																																																																	
Size	L	2.0	1.37	0.9																																																																																																																																
	W	1.25	1.0	0.6																																																																																																																																
a	0.5~0.6	0.35~0.45	0.25~0.35																																																																																																																																	
b	0.5~0.6	0.55~0.65	0.15~0.25																																																																																																																																	
c	0.5~0.6	0.3~0.4	0.15~0.25																																																																																																																																	
d	1.0	0.64	0.45																																																																																																																																	

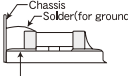
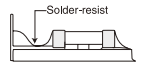
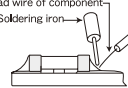
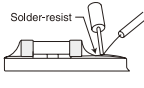
Precautions on the use of Multilayer Ceramic Capacitors

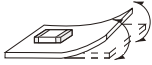
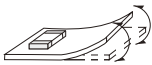
Stages	Precautions	Technical considerations																																																				
<p>2.PCB Design</p>	<p>Pattern configurations (Capacitor layout on panelized [breakaway] PC boards)</p> <p>1. After capacitors have been mounted on the boards, chips can be subjected to mechanical stresses in subsequent manufacturing processes (PCB cutting, board inspection, mounting of additional parts, assembly into the chassis, wave soldering the reflow soldered boards etc.) For this reason, planning pattern configurations and the position of SMD capacitors should be carefully performed to minimize stress.</p>	<p>LWDC Recommended land dimensions for reflow-soldering</p>  <table border="1" data-bbox="853 469 1236 655"> <thead> <tr> <th>Type</th> <th>105</th> <th>107</th> <th>212</th> <th>316</th> </tr> </thead> <tbody> <tr> <td rowspan="2">Size</td> <td>W</td> <td>1.0</td> <td>1.6</td> <td>2.0</td> <td>3.2</td> </tr> <tr> <td>L</td> <td>0.52</td> <td>0.8</td> <td>1.25</td> <td>1.6</td> </tr> <tr> <td>A</td> <td>0.18~0.22</td> <td>0.25~0.3</td> <td>0.5~0.7</td> <td>0.8~1.0</td> </tr> <tr> <td>B</td> <td>0.2~0.25</td> <td>0.3~0.4</td> <td>0.4~0.5</td> <td>0.4~0.5</td> </tr> <tr> <td>C</td> <td>0.9~1.1</td> <td>1.5~1.7</td> <td>1.9~2.1</td> <td>3.0~3.4</td> </tr> </tbody> </table> <p>(unit: mm)</p> <p>(2) Examples of good and bad solder application</p> <table border="1" data-bbox="845 753 1452 1190"> <thead> <tr> <th>Items</th> <th>Not recommended</th> <th>Recommended</th> </tr> </thead> <tbody> <tr> <td>Mixed mounting of SMD and leaded components</td> <td></td> <td></td> </tr> <tr> <td>Component placement close to the chassis</td> <td></td> <td></td> </tr> <tr> <td>Hand-soldering of leaded components near mounted components</td> <td></td> <td></td> </tr> <tr> <td>Horizontal component placement</td> <td></td> <td></td> </tr> </tbody> </table> <p>1-1. The following are examples of good and bad capacitor layout; SMD capacitors should be located to minimize any possible mechanical stresses from board warp or deflection.</p> <table border="1" data-bbox="845 1299 1452 1452"> <thead> <tr> <th></th> <th>Not recommended</th> <th>Recommended</th> </tr> </thead> <tbody> <tr> <td>Deflection of the board</td> <td></td> <td></td> </tr> </tbody> </table> <p>1-2. To layout the capacitors for the breakaway PC board, it should be noted that the amount of mechanical stresses given will vary depending on capacitor layout. The example below shows recommendations for better design.</p>  <p>Magnitude of stress <math>A &gt; B = C &gt; D &gt; E</math></p> <p>1-3. When breaking PC boards along their perforations, the amount of mechanical stress on the capacitors can vary according to the method used. The following methods are listed in order from least stressful to most stressful: push-back, slit, V-grooving, and perforation. Thus, any ideal SMD capacitor layout must also consider the PCB splitting procedure.</p>	Type	105	107	212	316	Size	W	1.0	1.6	2.0	3.2	L	0.52	0.8	1.25	1.6	A	0.18~0.22	0.25~0.3	0.5~0.7	0.8~1.0	B	0.2~0.25	0.3~0.4	0.4~0.5	0.4~0.5	C	0.9~1.1	1.5~1.7	1.9~2.1	3.0~3.4	Items	Not recommended	Recommended	Mixed mounting of SMD and leaded components			Component placement close to the chassis			Hand-soldering of leaded components near mounted components			Horizontal component placement				Not recommended	Recommended	Deflection of the board		
Type	105	107	212	316																																																		
Size	W	1.0	1.6	2.0	3.2																																																	
	L	0.52	0.8	1.25	1.6																																																	
A	0.18~0.22	0.25~0.3	0.5~0.7	0.8~1.0																																																		
B	0.2~0.25	0.3~0.4	0.4~0.5	0.4~0.5																																																		
C	0.9~1.1	1.5~1.7	1.9~2.1	3.0~3.4																																																		
Items	Not recommended	Recommended																																																				
Mixed mounting of SMD and leaded components																																																						
Component placement close to the chassis																																																						
Hand-soldering of leaded components near mounted components																																																						
Horizontal component placement																																																						
	Not recommended	Recommended																																																				
Deflection of the board																																																						

Precautions on the use of Multilayer Ceramic Capacitors

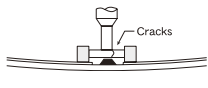
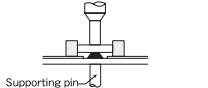
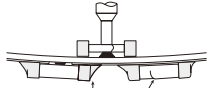
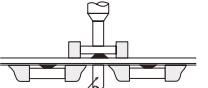
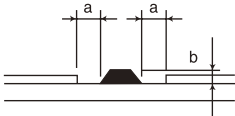
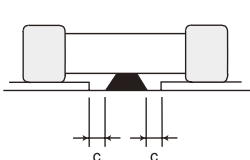
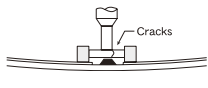
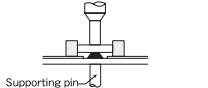
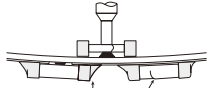
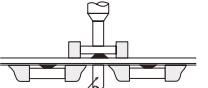
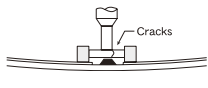
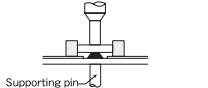
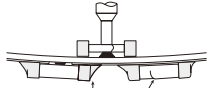
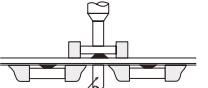
Stages	Precautions	Technical considerations																	
<p>3.Considerations for auto-matic placement</p>	<p>Adjustment of mounting machine</p> <ol style="list-style-type: none"> <li>Excessive impact load should not be imposed on the capacitors when mounting onto the PC boards.</li> <li>The maintenance and inspection of the mounters should be conducted periodically.</li> </ol> <p>Selection of Adhesives</p> <ol style="list-style-type: none"> <li>Mounting capacitors with adhesives in preliminary assembly, before the soldering stage, may lead to degraded capacitor characteristics unless the following factors are appropriately checked; the size of land patterns, type of adhesive, amount applied, hardening temperature and hardening period. Therefore, it is imperative to consult the manufacturer of the adhesives on proper usage and amounts of adhesive to use.</li> </ol>	<ol style="list-style-type: none"> <li>If the lower limit of the pick-up nozzle is low, too much force may be imposed on the capacitors, causing damage. To avoid this, the following points should be considered before lowering the pick-up nozzle:                     <ol style="list-style-type: none"> <li>The lower limit of the pick-up nozzle should be adjusted to the surface level of the PC board after correcting for deflection of the board.</li> <li>The pick-up pressure should be adjusted between 1 and 3 N static loads.</li> <li>To reduce the amount of deflection of the board caused by impact of the pick-up nozzle, supporting pins or back-up pins should be used under the PC board. The following diagrams show some typical examples of good pick-up nozzle placement:</li> </ol> </li> </ol> <table border="1" data-bbox="849 526 1452 797"> <thead> <tr> <th></th> <th>Not recommended</th> <th>Recommended</th> </tr> </thead> <tbody> <tr> <td>Single-sided mounting</td> <td></td> <td></td> </tr> <tr> <td>Double-sided mounting</td> <td></td> <td></td> </tr> </tbody> </table> <ol style="list-style-type: none"> <li>As the alignment pin wears out, adjustment of the nozzle height can cause chipping or cracking of the capacitors because of mechanical impact on the capacitors. To avoid this, the monitoring of the width between the alignment pin in the stopped position, and maintenance, inspection and replacement of the pin should be conducted periodically.</li> <li>Some adhesives may cause reduced insulation resistance. The difference between the shrinkage percentage of the adhesive and that of the capacitors may result in stresses on the capacitors and lead to cracking. Moreover, too little or too much adhesive applied to the board may adversely affect component placement, so the following precautions should be noted in the application of adhesives.                     <ol style="list-style-type: none"> <li>Required adhesive characteristics                             <ol style="list-style-type: none"> <li>The adhesive should be strong enough to hold parts on the board during the mounting &amp; solder process.</li> <li>The adhesive should have sufficient strength at high temperatures.</li> <li>The adhesive should have good coating and thickness consistency.</li> <li>The adhesive should be used during its prescribed shelf life.</li> <li>The adhesive should harden rapidly</li> <li>The adhesive must not be contaminated.</li> <li>The adhesive should have excellent insulation characteristics.</li> <li>The adhesive should not be toxic and have no emission of toxic gasses.</li> </ol> </li> <li>The recommended amount of adhesives is as follows;</li> </ol> </li> </ol> <table border="1" data-bbox="852 1469 1404 1589"> <thead> <tr> <th>Figure</th> <th>212/316 case sizes as examples</th> </tr> </thead> <tbody> <tr> <td>a</td> <td>0.3mm min</td> </tr> <tr> <td>b</td> <td>100 ~ 120 μm</td> </tr> <tr> <td>c</td> <td>Adhesives should not contact the pad</td> </tr> </tbody> </table> <div style="display: flex; justify-content: space-around; margin-top: 20px;"> <div data-bbox="874 1662 1109 1808"> <p>Amount of adhesive</p>  </div> <div data-bbox="1173 1662 1423 1852"> <p>After capacitors are bonded</p>  </div> </div>		Not recommended	Recommended	Single-sided mounting			Double-sided mounting			Figure	212/316 case sizes as examples	a	0.3mm min	b	100 ~ 120 μm	c	Adhesives should not contact the pad
	Not recommended	Recommended																	
Single-sided mounting																			
Double-sided mounting																			
Figure	212/316 case sizes as examples																		
a	0.3mm min																		
b	100 ~ 120 μm																		
c	Adhesives should not contact the pad																		

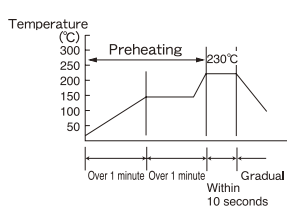
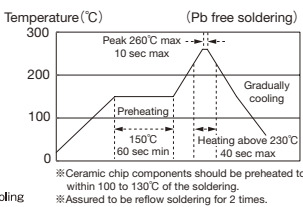
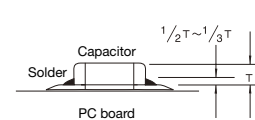
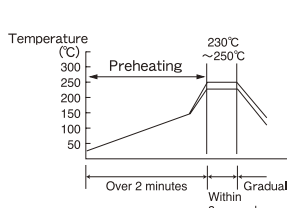
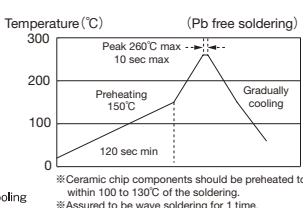

Precautions on the use of Multilayer Ceramic Capacitors

Stages	Precautions	Technical considerations
4. Soldering	<p><b>Selection of Flux</b></p> <p>1. Since flux may have a significant effect on the performance of capacitors, it is necessary to verify the following conditions prior to use;</p> <p>(1) Flux used should be with less than or equal to 0.1 wt% (equivalent to chlorine) of halogenated content. Flux having a strong acidity content should not be applied.</p> <p>(2) When soldering capacitors on the board, the amount of flux applied should be controlled at the optimum level.</p> <p>(3) When using water-soluble flux, special care should be taken to properly clean the boards.</p> <p><b>Soldering</b></p> <p>Temperature, time, amount of solder, etc. are specified in accordance with the following recommended conditions.</p> <p>Sn-Zn solder paste can affect MLCC reliability performance. Please contact us prior to usage.</p>	<p>1-1. When too much halogenated substance (Chlorine, etc.) content is used to activate the flux, or highly acidic flux is used, an excessive amount of residue after soldering may lead to corrosion of the terminal electrodes or degradation of insulation resistance on the surface of the capacitors.</p> <p>1-2. Flux is used to increase solderability in flow soldering, but if too much is applied, a large amount of flux gas may be emitted and may detrimentally affect solderability. To minimize the amount of flux applied, it is recommended to use a flux-bubbling system.</p> <p>1-3. Since the residue of water-soluble flux is easily dissolved by water content in the air, the residue on the surface of capacitors in high humidity conditions may cause a degradation of insulation resistance and therefore affect the reliability of the components. The cleaning methods and the capability of the machines used should also be considered carefully when selecting water-soluble flux.</p> <p>1-1. Preheating when soldering</p> <p>Heating: Ceramic chip components should be preheated to within 100 to 130°C of the soldering.</p> <p>Cooling: The temperature difference between the components and cleaning process should not be greater than 100°C.</p> <p>Ceramic chip capacitors are susceptible to thermal shock when exposed to rapid or concentrated heating or rapid cooling. Therefore, the soldering process must be conducted with great care so as to prevent malfunction of the components due to excessive thermal shock.</p> <p><b>Recommended conditions for soldering</b></p> <p>[Reflow soldering]</p> <p>Temperature profile</p>   <p>Caution</p> <p>1. The ideal condition is to have solder mass (fillet) controlled to 1/2 to 1/3 of the thickness of the capacitor, as shown below:</p>  <p>2. Because excessive dwell times can detrimentally affect solderability, soldering duration should be kept as close to recommended times as possible.</p> <p>[Wave soldering]</p> <p>Temperature profile</p>   <p>Caution</p> <p>1. Make sure the capacitors are preheated sufficiently.</p> <p>2. The temperature difference between the capacitor and melted solder should not be greater than 100 to 130°C</p> <p>3. Cooling after soldering should be as gradual as possible.</p> <p>4. Wave soldering must not be applied to the capacitors designated as for reflow soldering only.</p>

Precautions on the use of Multilayer Ceramic Capacitors

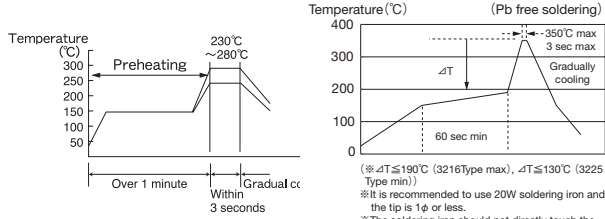
Stages	Precautions	Technical considerations
4. Soldering		<p>[Hand soldering]</p> <p>Temperature profile</p>  <p>Caution</p> <ol style="list-style-type: none"> <li>1. Use a 20W soldering iron with a maximum tip diameter of 1.0 mm.</li> <li>2. The soldering iron should not directly touch the capacitor.</li> </ol>
5. Cleaning	<p>Cleaning conditions</p> <ol style="list-style-type: none"> <li>1. When cleaning the PC board after the capacitors are all mounted, select the appropriate cleaning solution according to the type of flux used and purpose of the cleaning (e.g. to remove soldering flux or other materials from the production process.)</li> <li>2. Cleaning conditions should be determined after verifying, through a test run, that the cleaning process does not affect the capacitor's characteristics.</li> </ol>	<ol style="list-style-type: none"> <li>1. The use of inappropriate solutions can cause foreign substances such as flux residue to adhere to the capacitor or deteriorate the capacitor's outer coating, resulting in a degradation of the capacitor's electrical properties (especially insulation resistance).</li> <li>2. Inappropriate cleaning conditions (insufficient or excessive cleaning) may detrimentally affect the performance of the capacitors.</li> </ol> <p>(1) Excessive cleaning</p> <p>In the case of ultrasonic cleaning, too much power output can cause excessive vibration of the PC board which may lead to the cracking of the capacitor or the soldered portion, or decrease the terminal electrodes' strength. Thus the following conditions should be carefully checked;</p> <p>Ultrasonic output      Below 20 W/ℓ          Ultrasonic frequency      Below 40 kHz          Ultrasonic washing period      5 min. or less</p>
6. Post cleaning processes	<ol style="list-style-type: none"> <li>1. With some type of resins a decomposition gas or chemical reaction vapor may remain inside the resin during the hardening period or while left under normal storage conditions resulting in the deterioration of the capacitor's performance.</li> <li>2. When a resin's hardening temperature is higher than the capacitor's operating temperature, the stresses generated by the excess heat may lead to capacitor damage or destruction. The use of such resins, molding materials etc. is not recommended.</li> </ol>	
7. Handling	<p>Breakaway PC boards (splitting along perforations)</p> <ol style="list-style-type: none"> <li>1. When splitting the PC board after mounting capacitors and other components, care is required so as not to give any stresses of deflection or twisting to the board.</li> <li>2. Board separation should not be done manually, but by using the appropriate devices.</li> </ol> <p>Mechanical considerations</p> <ol style="list-style-type: none"> <li>1. Be careful not to subject the capacitors to excessive mechanical shocks.                     <ol style="list-style-type: none"> <li>(1) If ceramic capacitors are dropped onto the floor or a hard surface, they should not be used.</li> <li>(2) When handling the mounted boards, be careful that the mounted components do not come in contact with or bump against other boards or components.</li> </ol> </li> </ol>	

## Precautions on the use of Multilayer Ceramic Capacitors

Stages	Precautions	Technical considerations				
8.Storage conditions	<p>Storage</p> <p>1. To maintain the solderability of terminal electrodes and to keep the packaging material in good condition, care must be taken to control temperature and humidity in the storage area. Humidity should especially be kept as low as possible.</p> <p>• Recommended conditions</p> <table border="0" data-bbox="411 417 724 467"> <tr> <td>Ambient temperature</td> <td>Below 30°C</td> </tr> <tr> <td>Humidity</td> <td>Below 70% RH</td> </tr> </table> <p>The ambient temperature must be kept below 40°C. Even under ideal storage conditions capacitor electrode solderability decreases as time passes, so should be used within 6 months from the time of delivery.</p> <p>• Ceramic chip capacitors should be kept where no chlorine or sulfur exists in the air.</p> <p>2. The capacitance value of high dielectric constant capacitors (type 2 &amp;3) will gradually decrease with the passage of time, so this should be taken into consideration in the circuit design. If such a capacitance reduction occurs, a heat treatment of 150°C for 1hour will return the capacitance to its initial level.</p>	Ambient temperature	Below 30°C	Humidity	Below 70% RH	<p>1. If the parts are stored in a high temperature and humidity environment, problems such as reduced solderability caused by oxidation of terminal electrodes and deterioration of taping/package materials may take place. For this reason, components should be used within 6 months from the time of delivery. If exceeding the above period, please check solderability before using the capacitors.</p>
Ambient temperature	Below 30°C					
Humidity	Below 70% RH					