

Notice for TAIYO YUDEN products

Please read this notice before using the TAIYO YUDEN products.

⚠️ REMINDERS

■ Product Information in this Catalog

Product information in this catalog is as of January 2021. All of the contents specified herein and production status of the products listed in this catalog are subject to change without notice due to technical improvement of our products, etc. Therefore, please check for the latest information carefully before practical application or use of our products.

Please note that TAIYO YUDEN shall not be in any way responsible for any damages and defects in products or equipment incorporating our products, which are caused under the conditions other than those specified in this catalog or individual product specification sheets.

■ Approval of Product Specifications

Please contact TAIYO YUDEN for further details of product specifications as the individual product specification sheets are available. When using our products, please be sure to approve our product specifications or make a written agreement on the product specification with TAIYO YUDEN in advance.

■ Pre-Evaluation in the Actual Equipment and Conditions

Please conduct validation and verification of our products in actual conditions of mounting and operating environment before using our products.

■ Limited Application

1. Equipment Intended for Use

The products listed in this catalog are intended for general-purpose and standard use in general electronic equipment (e.g., AV equipment, OA equipment, home electric appliances, office equipment, information and communication equipment including, without limitation, mobile phone, and PC) and other equipment specified in this catalog or the individual product specification sheets.

TAIYO YUDEN has the line-up of the products intended for use in automotive electronic equipment, telecommunications infrastructure and industrial equipment, or medical devices classified as GHTF Classes A to C (Japan Classes I to III). Therefore, when using our products for these equipment, please check available applications specified in this catalog or the individual product specification sheets and use the corresponding products.

2. Equipment Requiring Inquiry

Please be sure to contact TAIYO YUDEN for further information before using the products listed in this catalog for the following equipment (excluding intended equipment as specified in this catalog or the individual product specification sheets) which may cause loss of human life, bodily injury, serious property damage and/or serious public impact due to a failure or defect of the products and/or malfunction attributed thereto.

- (1) Transportation equipment (automotive powertrain control system, train control system, and ship control system, etc.)
- (2) Traffic signal equipment
- (3) Disaster prevention equipment, crime prevention equipment
- (4) Medical devices classified as GHTF Class C (Japan Class III)
- (5) Highly public information network equipment, data-processing equipment (telephone exchange, and base station, etc.)
- (6) Any other equipment requiring high levels of quality and/or reliability equal to the equipment listed above

3. Equipment Prohibited for Use

Please do not incorporate our products into the following equipment requiring extremely high levels of safety and/or reliability.

- (1) Aerospace equipment (artificial satellite, rocket, etc.)
- (2) Aviation equipment *¹
- (3) Medical devices classified as GHTF Class D (Japan Class IV), implantable medical devices *²

- (4) Power generation control equipment (nuclear power, hydroelectric power, thermal power plant control system, etc.)
- (5) Undersea equipment (submarine repeating equipment, underwater work equipment, etc.)
- (6) Military equipment
- (7) Any other equipment requiring extremely high levels of safety and/or reliability equal to the equipment listed above

*Notes:

1. There is a possibility that our products can be used only for aviation equipment that does not directly affect the safe operation of aircraft (e.g., in-flight entertainment, cabin light, electric seat, cooking equipment) if such use meets requirements specified separately by TAIYO YUDEN. Please be sure to contact TAIYO YUDEN for further information before using our products for such aviation equipment.
2. Implantable medical devices contain not only internal unit which is implanted in a body, but also external unit which is connected to the internal unit.

4. Limitation of Liability

Please note that unless you obtain prior written consent of TAIYO YUDEN, TAIYO YUDEN shall not be in any way responsible for any damages incurred by you or third parties arising from use of the products listed in this catalog for any equipment that is not intended for use by TAIYO YUDEN, or any equipment requiring inquiry to TAIYO YUDEN or prohibited for use by TAIYO YUDEN as described above.

■ Safety Design

When using our products for high safety and/or reliability-required equipment or circuits, please fully perform safety and/or reliability evaluation. In addition, please install (i) systems equipped with a protection circuit and a protection device and/or (ii) systems equipped with a redundant circuit or other system to prevent an unsafe status in the event of a single fault for a failsafe design to ensure safety.

■ Intellectual Property Rights

Information contained in this catalog is intended to convey examples of typical performances and/or applications of our products and is not intended to make any warranty with respect to the intellectual property rights or any other related rights of TAIYO YUDEN or any third parties nor grant any license under such rights.

■ Limited Warranty

Please note that the scope of warranty for our products is limited to the delivered our products themselves and TAIYO YUDEN shall not be in any way responsible for any damages resulting from a failure or defect in our products. Notwithstanding the foregoing, if there is a written agreement (e.g., supply and purchase agreement, quality assurance agreement) signed by TAIYO YUDEN and your company, TAIYO YUDEN will warrant our products in accordance with such agreement.

■ TAIYO YUDEN's Official Sales Channel

The contents of this catalog are applicable to our products which are purchased from our sales offices or authorized distributors (hereinafter "TAIYO YUDEN's official sales channel"). Please note that the contents of this catalog are not applicable to our products purchased from any seller other than TAIYO YUDEN's official sales channel.

■ Caution for Export

Some of our products listed in this catalog may require specific procedures for export according to "U.S. Export Administration Regulations", "Foreign Exchange and Foreign Trade Control Law" of Japan, and other applicable regulations. Should you have any questions on this matter, please contact our sales staff.

▶ This catalog contains the typical specification only due to the limitation of space. When you consider the purchase of our products, please check our product specification sheets. For details of each product (characteristics graph, reliability information, precautions for use, and so on), see our website (<http://www.ty-top.com/>).

Industrial Application Guide

APPLICATION GUIDE

INDUSTRIAL APPLICATION GUIDE

The products described as “For Telecommunications Infrastructure and Industrial Equipment” in this catalog are intended for use in the equipment shown in the below table as its typical example. Therefore, when using our products for these equipment, please check it carefully by referring to the part number or the individual product specification sheets and use the corresponding products. Should you have any questions on this matter, please contact us.

Category	Telecommunications Infrastructure and Industrial Equipment (Typical Example)
Telecommunications Infrastructure	<ul style="list-style-type: none"> • Base Station • Optical Transceiver • Router/Switch (Carrier-Grade) • UPS (Uninterruptible Power Supply), etc.
Factory Automation	<ul style="list-style-type: none"> • PLC (Programmable Logic Controller) • Servomotor/Servo Driver • Industry Robot, etc.
Measurement	<ul style="list-style-type: none"> • Gas Meter • Water Meter • Flow Meter • Pressure Gauge Meter • Magnetometer • Thermometer, etc.
Electric Power Apparatus	<ul style="list-style-type: none"> • Power Conditioner (Solar Power System) • Smart Meter • GFCI (Ground Fault Circuit Interrupter) • Electric Vehicle Charging Station, etc.

Part Numbering System

Multilayer Ceramic Capacitors:

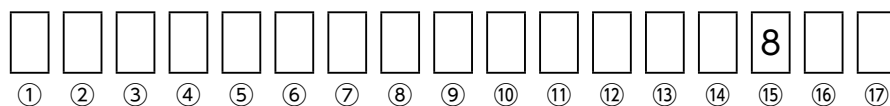

If the 15th code from the left is “8”, it indicates “For Telecommunications Infrastructure and Industrial Equipment” or “For Medical Devices”.

Inductors:

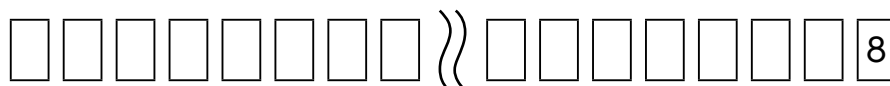

If the 1st code from the right is “8” regardless of the total digit number, it indicates “For Telecommunications Infrastructure and Industrial Equipment” or “For Medical Devices”.

Because there are some exceptions, for details please refer to each page of this catalog where the part numbering system of each product is described.

▶ This catalog contains the typical specification only due to the limitation of space. When you consider the purchase of our products, please check our product specification sheets. For details of each product (characteristics graph, reliability information, precautions for use, and so on), see our website (<http://www.ty-top.com/>).

Medical Application Guide

The products described as “For Medical Devices” in this catalog are intended for use in the medical devices classified as GHTF Classes A to C (Japan Classes I to III) except for all medical devices classified as GHTF Class D (Japan Class IV) and implantable medical devices (bone-anchored hearing aid, artificial retina system, and external unit which is connected to internal unit which is implanted in a body, etc.). Therefore, when using our products for these medical devices, please check it carefully by referring to the part number or the individual product specification sheets and use the corresponding products. Should you have any questions on this matter, please contact us.

Risk Level					
Japan	Classification according to the PMD Act of Japan (based on the GHTF Rules)	Class I General Medical Devices (GHTF Class A)	Class II Controlled Medical Devices (GHTF Class B)	Class III Specially-controlled Medical Devices (GHTF Class C)	Class IV Specially-controlled Medical Devices (GHTF Class D)
		Medical devices with extremely low risk to the human body in case of problems [Ex.] • In Vitro Diagnostic Devices • Nebulizer • Blood Gas Analyzer • Plethysmographs • Breathing Sensor • AC-powered Operating Table • Surgical Light • Cholesterol Analysis Device • Blood Type Analysis Device, etc.	Medical devices with relatively low risk to the human body in case of problems [Ex.] • Electronic Thermometer • Electronic Blood Pressure Gauge • Electronic Endoscope • Hearing Aid • Electrocardiograph • MRI • Ultrasonic Diagnostic System • Diagnostic Imaging Equipment • X-ray Diagnostic Equipment • Central Monitor • Pulse Oximeter, etc.	Medical devices with relatively high risk to the human body in case of problems [Ex.] • Dialysis Machine • Radiation Therapy Equipment • Infusion Pump • Respirator • Glucose Monitoring System • AED (Automated External Defibrillator) • Skin Laser Scanner • Electric Surgical Unit • Insulin Pump, etc.	Medical devices highly invasive to patients and with life-threatening risk in case of problems [Ex.] • Cardiac Pacemaker • Video Flexible Angioscope • Implantable Infusion Pump • Cardiac Electrosurgical Unit • Inspection Device with Cardiac Catheter • Defibrillator, etc.
U.S.A.	FDA Classification	Class I General Controls	Class II General Controls and Special Controls	Class III General Controls and Premarket Approval	
		Medical devices without the possibility of causing serious injury or harm to the patient or user even if there is a defect or malfunction in such medical devices	Medical devices with the possibility of causing injury or harm to the patient or user if there is a defect or malfunction in such medical devices	Medical devices with the possibility of causing serious injury, disability or death to the patient or user if a defect or malfunction occurs in such medical devices	

Coverage of those Classes by TAIYO YUDEN Products	Product Series for Medical Devices *Note: It is prohibited that our products are used in some medical devices such as implantable medical devices even if such medical devices are classified as GHTF Class C (Japan Class III).	N/A
---	--	-----

► This catalog contains the typical specification only due to the limitation of space. When you consider the purchase of our products, please check our product specification sheets. For details of each product (characteristics graph, reliability information, precautions for use, and so on), see our website (<http://www.ty-top.com/>).

CHIP BEAD INDUCTORS FOR POWER LINES (FB SERIES T TYPE)

REFLOW

AEC-Q200

AEC-Q200 Grade 1 (we conduct the evaluation at the test condition of Grade 1.)

*Operating environment Temp:-40~125°C

■ PART NUMBER

*Operating Temp. : -40~150°C (Including self-generated heat)

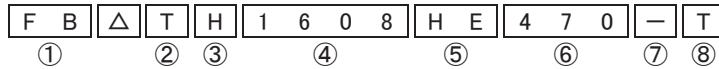

Δ = Blank space

① Series name

Code	Series name
FB	Ferrite bead

② Shape

Code	Shape
T	Rectangular chip (High-Reliability)

③ Characteristics

Code	Characteristics
H	High Impedance type

④ Dimensions (L × W)

Code	Type (inch)	Dimensions (L × W) [mm]
1608	1608 (0603)	1.6 × 0.8

⑤ Material

Code	Material
HE	Refer to impedance curves for material differences
HL	

⑥ Nominal impedance

Code (example)	Nominal impedance [Ω]
300	30
221	220
102	1000

⑦ Impedance tolerance

Code	Impedance tolerance
-	±25%

⑧ Packaging

Code	Packaging
T	Taping

■ FEATURES

- HE: For upper MHz range applications
- HL: For GHz range applications

■ STANDARD EXTERNAL DIMENSIONS / STANDARD QUANTITY

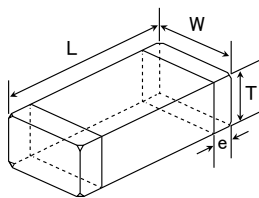

Recommended Land Patterns

Surface Mounting

• Mounting and soldering conditions should be checked beforehand.

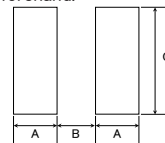

Type	A	B	C
FB TH1608	1.0	1.0	1.0

Unit: mm

Type	L	W	T	e	Standard quantity [pcs]	
					Paper tape	Embossed tape
FB TH1608 (0603)	1.6±0.15 (0.063±0.006)	0.8±0.15 (0.031±0.006)	0.8±0.15 (0.031±0.006)	0.4±0.2 (0.015±0.008)	4000	-

Unit: mm (inch)

▶ This catalog contains the typical specification only due to the limitation of space. When you consider the purchase of our products, please check our product specification sheets. For details of each product (characteristics graph, reliability information, precautions for use, and so on), see our website (<http://www.ty-top.com/>).

■ PART NUMBER

- All the Chip Bead Inductors for Power Lines of the catalog lineup are RoHS compliant.

Notes)

- The exchange of individual specifications is necessary depending on your application and/or circuit condition. Please contact TAIYO YUDEN's official sales channel.
- For Automotive (AEC-Q200 Qualified) products for POWERTRAIN, and SAFETY. Please check "Automotive Application Guide" for further details before using the products.
 - < AEC-Q200 : AEC-Q200 qualified >
 - All the Chip Bead Inductors for Power Lines for Automotive products are tested based on the test conditions and methods defined in AEC-Q200 by family item. Please consult with TAIYO YUDEN's official sales channel for the details of the product specifications and AEC-Q200 test results, etc., and please review and approve the product specifications before ordering.
- The products are for Telecommunications infrastructure and Industrial equipment and for Medical devices. Please consult with TAIYO YUDEN's official sales channel for the details of the product specifications, etc., and please review and approve the product specifications before ordering. Please be sure to contact us for further information in advance when the products are used for automotive electronic equipment.

● FB TH1608HE

Part number	Nominal impedance (Ω)	Impedance tolerance	Measuring frequency [MHz]	DC Resistance [Ω] (max.)	Rated current [A] (max.)	Thickness [mm]	Note
FB TH1608HE470-T	47	±25%	100	0.020	2.5	0.8 ±0.15	
FB TH1608HE600-T	60	±25%	100	0.025	2.3	0.8 ±0.15	
FB TH1608HE101-T	100	±25%	100	0.035	1.9	0.8 ±0.15	
FB TH1608HE151-T	150	±25%	100	0.050	1.5	0.8 ±0.15	
FB TH1608HE221-T	220	±25%	100	0.070	1.3	0.8 ±0.15	
FB TH1608HE331-T	330	±25%	100	0.130	0.9	0.8 ±0.15	
FB TH1608HE471-T	470	±25%	100	0.150	0.7	0.8 ±0.15	
FB TH1608HE601-T	600	±25%	100	0.170	0.6	0.8 ±0.15	
FB TH1608HE102-T	1000	±25%	100	0.350	0.5	0.8 ±0.15	

● FB TH1608HL

Part number	Nominal impedance (Ω)	Impedance tolerance	Measuring frequency [MHz]	DC Resistance [Ω] (max.)	Rated current [A] (max.)	Thickness [mm]	Note
FB TH1608HL300-T	30	±25%	100	0.028	2.00	0.8 ±0.15	
FB TH1608HL600-T	60	±25%	100	0.045	1.60	0.8 ±0.15	
FB TH1608HL121-T	120	±25%	100	0.130	0.95	0.8 ±0.15	
FB TH1608HL221-T	220	±25%	100	0.170	0.65	0.8 ±0.15	
FB TH1608HL331-T	330	±25%	100	0.210	0.60	0.8 ±0.15	
FB TH1608HL471-T	470	±25%	100	0.350	0.50	0.8 ±0.15	
FB TH1608HL601-T	600	±25%	100	0.450	0.42	0.8 ±0.15	

※) The rated current is the value of current at which the temperature of the element is increased by 25 deg.

► This catalog contains the typical specification only due to the limitation of space. When you consider the purchase of our products, please check our product specification sheets. For details of each product (characteristics graph, reliability information, precautions for use, and so on), see our website (<http://www.ty-top.com/>).

ELECTRICAL CHARACTERISTICS

FB TH1608HE

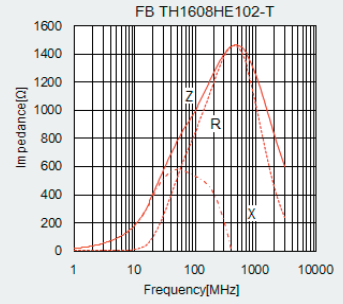
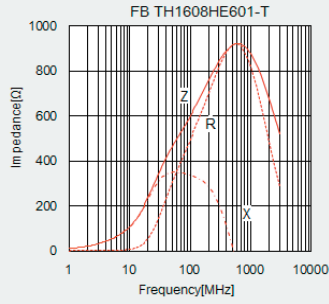
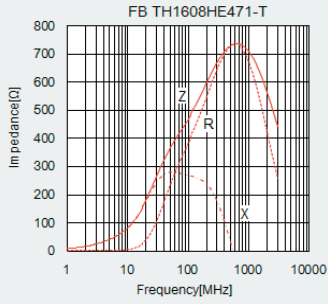
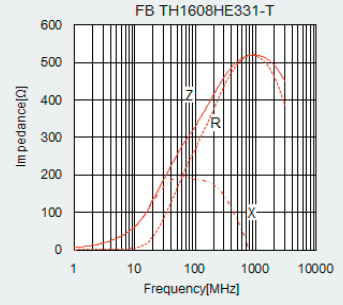
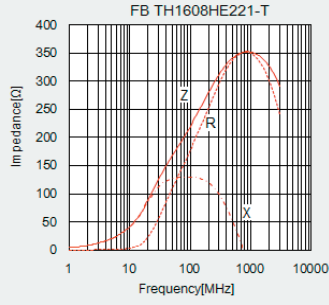
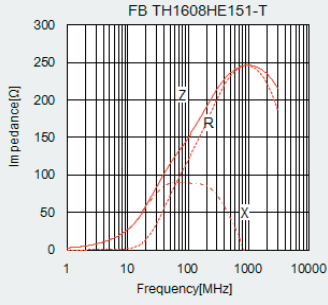
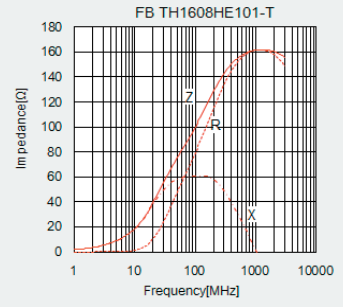
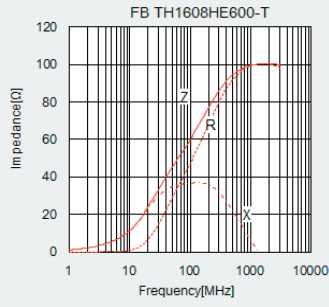
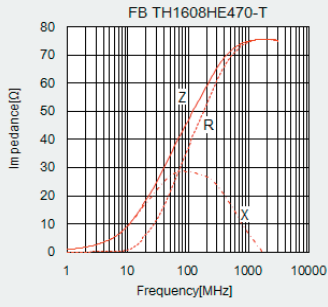

FB TH1608HL

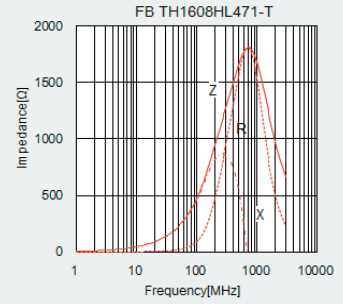
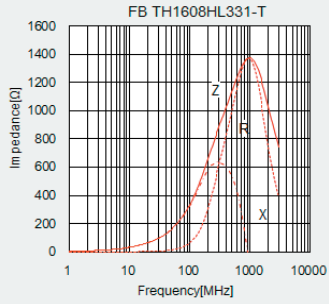
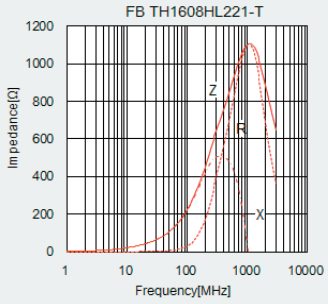
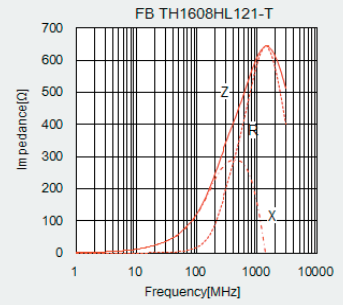
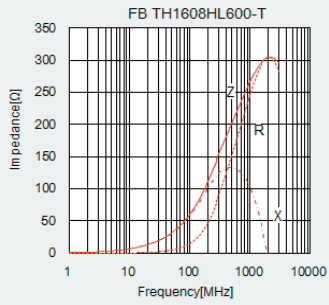
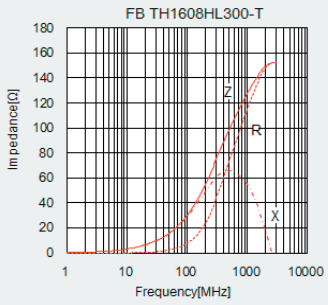

NOISE SUPPRESSION COMPONENTS

INDL

For Telecommunications Infrastructure and Industrial Equipment / Medical Devices
CHIP BEAD INDUCTORS FOR POWER LINES (FB SERIES T TYPE)

▶ This catalog contains the typical specification only due to the limitation of space. When you consider the purchase of our products, please check our product specification sheets. For details of each product (characteristics graph, reliability information, precautions for use, and so on), see our website (<http://www.ty-top.com/>).

ELECTRICAL CHARACTERISTICS

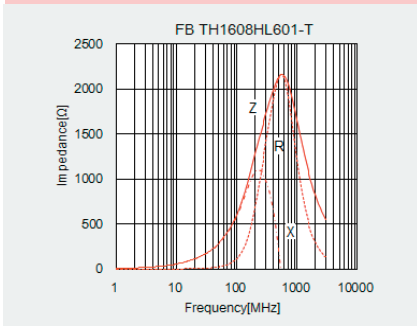

Derating of Rated Current

FB series T type

Derating of current is necessary for FB series T type depending on ambient temperature. Please refer to the chart shown below for appropriate derating of current.

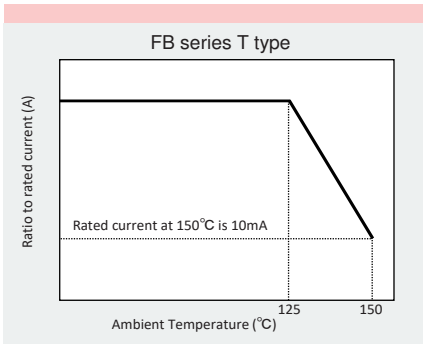

► This catalog contains the typical specification only due to the limitation of space. When you consider the purchase of our products, please check our product specification sheets. For details of each product (characteristics graph, reliability information, precautions for use, and so on), see our website (<http://www.ty-top.com/>).

CHIP BEAD INDUCTORS FOR POWER LINES (FB SERIES M TYPE / T TYPE)

PACKAGING

① Minimum Quantity

Type	Standard Quantity [pcs]	
	Paper Tape	Embossed Tape
1608 (0603)	4000	—
2125 (0805)	4000	—
2012 (0805)	4000	—
2016 (0806)	—	2000
3216 (1206)	—	2000
3225 (1210)	—	1000
4516 (1806)	—	2000
4525 (1810)	—	1000
4532 (1812)	—	2000

② Tape Material

● Card board carrier tape

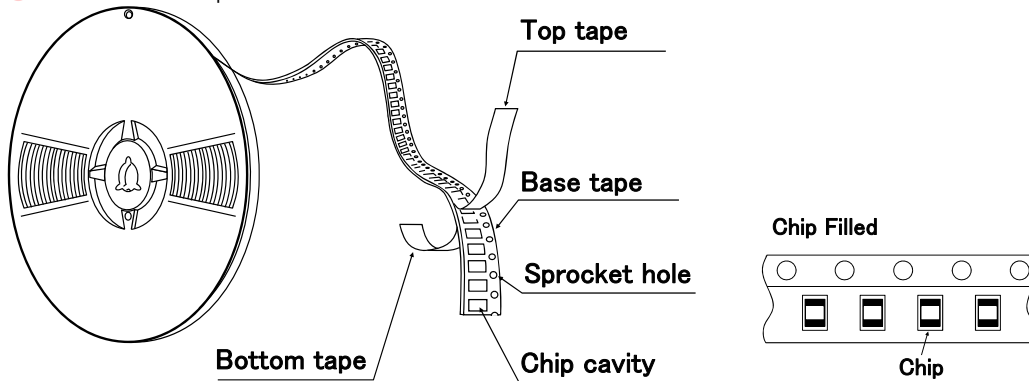

● Embossed tape

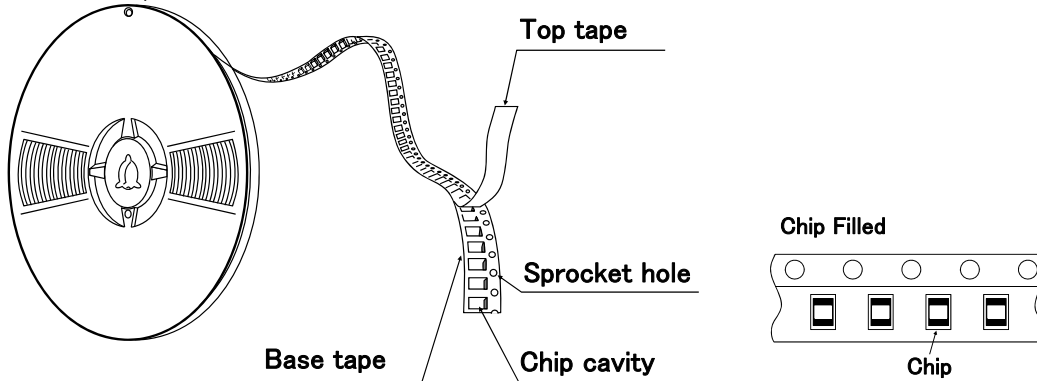

③ Taping Dimensions

● Paper tape (0.315 inches wide)

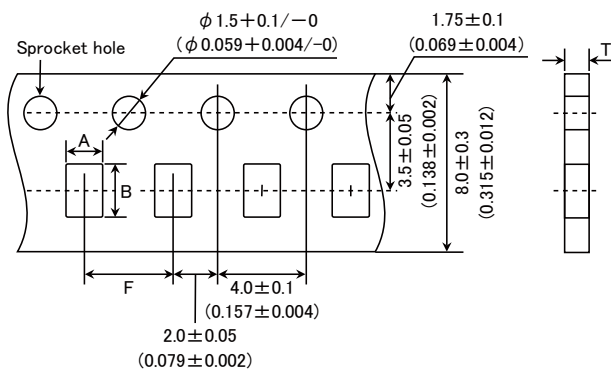

▶ This catalog contains the typical specification only due to the limitation of space. When you consider the purchase of our products, please check our specification. For details of each product (characteristics graph, reliability information, precautions for use, and so on), see our Web site (<http://www.ty-top.com/>).

Type	Chip Cavity		Insertion Pitch	Tape Thickness
	A	B	F	T
FB MJ1608 FB MH1608 FB TH1608 (0603)	1.0±0.2 (0.039±0.008)	1.8±0.2 (0.071±0.008)	4.0±0.2 (0.157±0.008)	1.1max (0.043max)
FB MJ2125 FB MH2012 (0805)	1.5±0.2 (0.059±0.008)	2.3±0.2 (0.091±0.008)	4.0±0.2 (0.157±0.008)	1.1max (0.043max)

Unit : mm (inch)

● Embossed tape (0.315 inches wide)

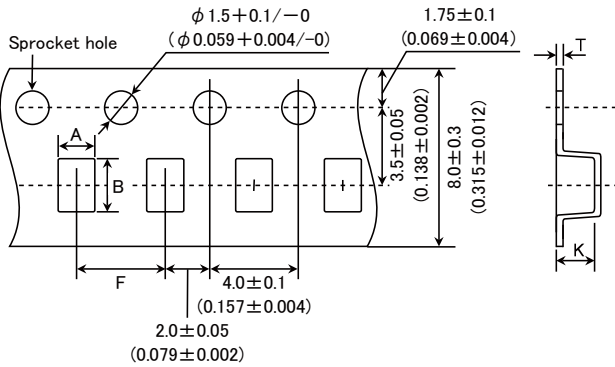

Type	Chip Cavity		Insertion Pitch	Tape Thickness	
	A	B	F	K	T
FB MH2016 (0806)	1.8±0.2 (0.071±0.008)	2.2±0.2 (0.087±0.008)	4.0±0.2 (0.157±0.008)	2.6max (0.102max)	0.6max (0.024max)
FB MJ3216 (1206)	1.9±0.2 (0.075±0.008)	3.5±0.2 (0.138±0.008)	4.0±0.2 (0.157±0.008)	1.5max (0.059max)	0.3max (0.012max)
FB MH3216 (1206)	1.9±0.2 (0.075±0.008)	3.5±0.2 (0.138±0.008)	4.0±0.2 (0.157±0.008)	2.6max (0.102max)	0.6max (0.024max)
FB MH3225 (1210)	2.8±0.2 (0.110±0.008)	3.5±0.2 (0.138±0.008)	4.0±0.2 (0.157±0.008)	4.0max (0.157max)	0.6max (0.024max)

Unit : mm (inch)

● Embossed tape (0.472 inches wide)

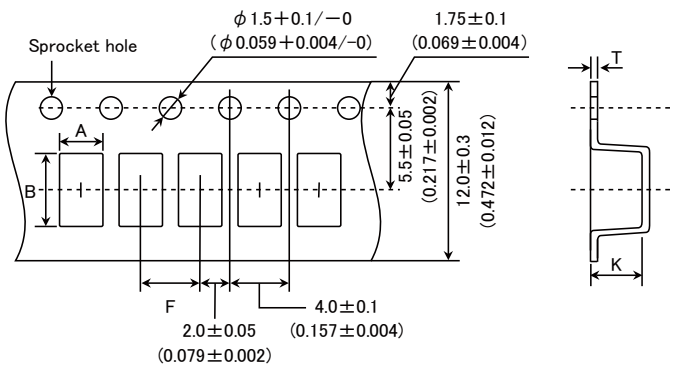

Type	Chip Cavity		Insertion Pitch	Tape Thickness	
	A	B	F	K	T
FB MJ4516 (1806)	1.9±0.2 (0.075±0.008)	4.9±0.2 (0.193±0.008)	4.0±0.2 (0.157±0.008)	1.5max (0.059max)	0.3max (0.012max)
FB MH4516 (1806)	1.9±0.2 (0.075±0.008)	4.9±0.2 (0.193±0.008)	4.0±0.2 (0.157±0.008)	2.6max (0.102max)	0.6max (0.024max)
FB MH4525 (1810)	2.9±0.2 (0.114±0.008)	4.9±0.2 (0.193±0.008)	4.0±0.2 (0.157±0.008)	4.0max (0.157max)	0.6max (0.024max)
FB MH4532 (1812)	3.6±0.2 (0.142±0.008)	4.9±0.2 (0.193±0.008)	8.0±0.2 (0.315±0.008)	4.0max (0.157max)	0.6max (0.024max)

Unit : mm (inch)

▶ This catalog contains the typical specification only due to the limitation of space. When you consider the purchase of our products, please check our specification. For details of each product (characteristics graph, reliability information, precautions for use, and so on), see our Web site (<http://www.ty-top.com/>).

④ Leader and Blank portion



Insertion leader is 400 mm or more (including 20 empty cavities)
 Empty cavities at end of reel: 40 holes or more

⑤ Reel size

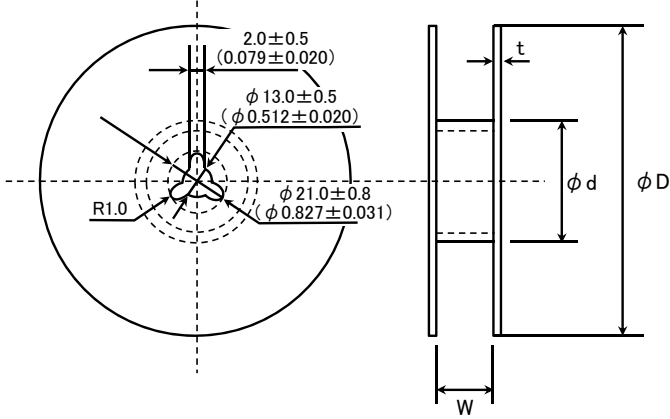

Type	ϕD	ϕd	W	t
FB MJ1608	180+0/-3 (7.09+0/-0.118)	60+1/-0 (2.36+0.039/-0)	10.0±1.5 (0.394±0.059)	2.5max (0.098max)
FB MJ2125			14.0±1.5 (0.551±0.059)	
FB MJ3216				
FB MJ4516			10.0±1.5 (0.394±0.059)	
FB MH1608				
FB MH2012			14.0±1.5 (0.551±0.059)	
FB MH2016				
FB MH3216				
FB MH3225				
FB MH4516				
FB MH4525	330±2.0 (12.99±0.080)	100±1.0 (3.94±0.039)	14.0±2.0 (0.551±0.080)	3.0max (1.181max)
FB MH4532				
FB TH1608	180+0/-3 (7.09+0/-0.118)	60+1/-0 (2.36+0.039/-0)	10.0±1.5 (0.394±0.059)	2.5max (0.098max)

Unit : mm (inch)

⑥ Top tape strength

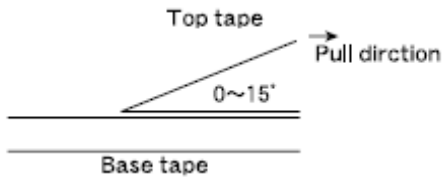

The top tape requires a peel-off force of 0.1 to 0.7N in the direction of the arrow as illustrated below.

CHIP BEAD INDUCTORS FOR POWER LINE (FB SERIES T TYPE)

RELIABILITY DATA

1. Operating Temperature Range															
Specified Value	-40°C ~ +150°C (Including self-generated heat)														
Test Methods and Remarks	Including self-generated heat														
2. Storage Temperature Range															
Specified Value	-40°C ~ +125°C														
Test Methods and Remarks	*Note: -5 to +40°C in taped packaging														
3. Impedance															
Specified Value	Within the specified range														
Test Methods and Remarks	Measuring equipment : Impedance analyzer (E4991) or its equivalent Measuring frequency : 100±1 MHz														
4. DC Resistance															
Specified Value	Within the specified range														
Test Methods and Remarks	Four-terminal method Measuring equipment : Milliohm High-Tester 3226 (Hioki Denki) or its equivalent														
5. Rated Current															
Specified Value	Within the specified range														
6. Vibration															
Specified Value	Appearance : No significant abnormality Impedance change : Within ±30% of the initial value														
Test Methods and Remarks	AEC-Q200 Test No.14 qualified (MIL-STD-202 Method 204) The test samples shall be soldered to the test board by the reflow. Then it shall be submitted to below test conditions. <table border="1"> <tr> <td>Frequency Range</td> <td colspan="2">10~2000Hz</td> </tr> <tr> <td>Total Amplitude</td> <td colspan="2">5G</td> </tr> <tr> <td>Sweeping Method</td> <td colspan="2">10Hz to 2000Hz to 10Hz for 20min.</td> </tr> <tr> <td rowspan="3">Number of cycle</td> <td>X</td> <td rowspan="3">For 12 cycles on each X, Y, and Z axis.</td> </tr> <tr> <td>Y</td> </tr> <tr> <td>Z</td> </tr> </table>	Frequency Range	10~2000Hz		Total Amplitude	5G		Sweeping Method	10Hz to 2000Hz to 10Hz for 20min.		Number of cycle	X	For 12 cycles on each X, Y, and Z axis.	Y	Z
Frequency Range	10~2000Hz														
Total Amplitude	5G														
Sweeping Method	10Hz to 2000Hz to 10Hz for 20min.														
Number of cycle	X	For 12 cycles on each X, Y, and Z axis.													
	Y														
	Z														
7. Mechanical Shock															
Specified Value	Appearance : No significant abnormality Impedance change : Within ±30% of the initial value														
Test Methods and Remarks	AEC-Q200 Test No.13qualified (MIL-STD-202 Method213) The test samples shall be soldered to the test board by the reflow. Then it shall be submitted to below test conditions. <table border="1"> <tr> <td>Acceleration</td> <td>981m/s²</td> </tr> <tr> <td>Duration</td> <td>6msec(Half sine pulse)</td> </tr> <tr> <td>Direction</td> <td>+X, +Y, +Z, -X, -Y, -Z</td> </tr> <tr> <td>Number of time</td> <td>Each 3 times, Total 18 times</td> </tr> </table>	Acceleration	981m/s ²	Duration	6msec(Half sine pulse)	Direction	+X, +Y, +Z, -X, -Y, -Z	Number of time	Each 3 times, Total 18 times						
Acceleration	981m/s ²														
Duration	6msec(Half sine pulse)														
Direction	+X, +Y, +Z, -X, -Y, -Z														
Number of time	Each 3 times, Total 18 times														
8. Solderability															
Specified Value	90% or more of immersed surface of terminal electrode shall be covered with fresh solder.														
Test Methods and Remarks	AEC-Q200 Test No.18qualified (J-STD-002) <table border="1"> <tr> <td></td> <td>(a) Method B</td> <td>(c) Method D</td> </tr> <tr> <td>Preconditioning</td> <td>155°C 4hrs</td> <td>Steam 8hrs±15min</td> </tr> <tr> <td>Solder Temperature</td> <td>235±5°C</td> <td>260±5°C</td> </tr> <tr> <td>Time</td> <td>5+0/-0.5 sec</td> <td>30+0/-0.5 sec.</td> </tr> </table>		(a) Method B	(c) Method D	Preconditioning	155°C 4hrs	Steam 8hrs±15min	Solder Temperature	235±5°C	260±5°C	Time	5+0/-0.5 sec	30+0/-0.5 sec.		
	(a) Method B	(c) Method D													
Preconditioning	155°C 4hrs	Steam 8hrs±15min													
Solder Temperature	235±5°C	260±5°C													
Time	5+0/-0.5 sec	30+0/-0.5 sec.													

▶ This catalog contains the typical specification only due to the limitation of space. When you consider the purchase of our products, please check our specification. For details of each product (characteristics graph, reliability information, precautions for use, and so on), see our Web site (<http://www.ty-top.com/>).

9. Resistance to Soldering Heat

Specified Value	Appearance : No significant abnormality Impedance change : Within $\pm 30\%$ of the initial value
Test Methods and Remarks	AEC-Q200 Test No.15 qualified (MIL-STD-202 Method 210) Condition: K The test sample shall be exposed to reflow oven at 183°C for 90-120 seconds, with peak temperature at $250 \pm 5^{\circ}\text{C}$ for 30 ± 5 seconds, 3 times.

10. Thermal Shock

Specified Value	Appearance : No significant abnormality Impedance change : Within $\pm 50\%$ of the initial value				
Test Methods and Remarks	AEC-Q200 Test No.04 qualified (JESD22 Method JA-104) The test samples shall be soldered to the test board by the reflow. The test samples shall be placed at specified temperature for specified time by following condition.				
	<table border="1"> <tr> <td>1 Cycle</td> <td>$-40 \pm 3^{\circ}\text{C}/30 \text{ min} \leftrightarrow 150 \pm 3^{\circ}\text{C}/30 \text{ min}$</td> </tr> <tr> <td>Number of cycle</td> <td>1000 cycles</td> </tr> </table>	1 Cycle	$-40 \pm 3^{\circ}\text{C}/30 \text{ min} \leftrightarrow 150 \pm 3^{\circ}\text{C}/30 \text{ min}$	Number of cycle	1000 cycles
1 Cycle	$-40 \pm 3^{\circ}\text{C}/30 \text{ min} \leftrightarrow 150 \pm 3^{\circ}\text{C}/30 \text{ min}$				
Number of cycle	1000 cycles				

11. Resistance to Humidity (steady state)

Specified Value	Appearances : No significant abnormality Impedance change : Within $\pm 50\%$ of the initial value						
Test Methods and Remarks	AEC-Q200 Test No.07 qualified (MIL-STD-202 Method 103) The test samples shall be soldered to the test board by the reflow. The test samples shall be placed in thermostatic oven set at specified temperature and humidity as shown in below table.						
	<table border="1"> <tr> <td>Temperature</td> <td>$85 \pm 2^{\circ}\text{C}$</td> </tr> <tr> <td>Humidity</td> <td>85%RH</td> </tr> <tr> <td>Time</td> <td>$1000 + 24 / - 0$ hour</td> </tr> </table>	Temperature	$85 \pm 2^{\circ}\text{C}$	Humidity	85%RH	Time	$1000 + 24 / - 0$ hour
Temperature	$85 \pm 2^{\circ}\text{C}$						
Humidity	85%RH						
Time	$1000 + 24 / - 0$ hour						

12. High Temperature Exposure

Specified Value	Appearances : No significant abnormality Impedance change : Within $\pm 50\%$ of the initial value				
Test Methods and Remarks	AEC-Q200 Test No.03 qualified (MIL-STD-202 Method 108) The test samples shall be soldered to the test board by the reflow soldering. The test samples shall be placed in thermostatic oven set at specified temperature as shown in below table.				
	<table border="1"> <tr> <td>Temperature</td> <td>$150 \pm 3^{\circ}\text{C}$</td> </tr> <tr> <td>Time</td> <td>$1000 + 24 / - 0$ hour</td> </tr> </table>	Temperature	$150 \pm 3^{\circ}\text{C}$	Time	$1000 + 24 / - 0$ hour
Temperature	$150 \pm 3^{\circ}\text{C}$				
Time	$1000 + 24 / - 0$ hour				

13. High Temperature Loading Test

Specified Value	Appearance : No significant abnormality Impedance change : Within $\pm 50\%$ of the initial value						
Test Methods and Remarks	AEC-Q200 Test No.08 qualified (MIL-PRF-27) The test samples shall be soldered to the test board by the reflow soldering. The test samples shall be placed in thermostatic oven set at specified temperature and applied the rated current continuously as shown in below table.						
	<table border="1"> <tr> <td>Temperature</td> <td>$125 \pm 3^{\circ}\text{C}$</td> </tr> <tr> <td>Applied current</td> <td>Rated current</td> </tr> <tr> <td>Time</td> <td>$1000 + 24 / - 0$ hour</td> </tr> </table>	Temperature	$125 \pm 3^{\circ}\text{C}$	Applied current	Rated current	Time	$1000 + 24 / - 0$ hour
Temperature	$125 \pm 3^{\circ}\text{C}$						
Applied current	Rated current						
Time	$1000 + 24 / - 0$ hour						

14. Bending Strength

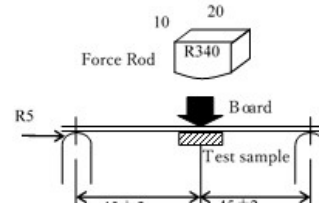
Specified Value	Appearance : No mechanical damage.
Test Methods and Remarks	AEC-Q200 Test No.21 qualified (AEC-Q200-005) The test samples shall be soldered to the test board by the reflow. As illustrated below, apply force in the direction of the arrow indicating until deflection of the test board reaches to 2 mm for 60 s. Test board size : $100 \times 40 \times 1.6$ Test board material : glass epoxy-resin
	

* This catalog contains the typical specification only due to the limitation of space. When you consider the purchase of our products, please check our specification.
For details of each product (characteristics graph, reliability information, precautions for use, and so on), see our Web site (<http://www.ty-top.com/>).

15. Adhesion of Electrode

Specified Value	Impedance change : Within $\pm 30\%$ of the initial value
-----------------	---

Test Methods and Remarks	AEC-Q200 Test No.22 qualified (AEC-Q200-006)
	The test samples shall be soldered to the test board by the reflow soldering.
	Applied force : 10N Duration : 60 sec.

Note on standard condition: "standard condition" referred to herein is defined as follows:
5 to 35°C of temperature, 45 to 85% relative humidity and 86 to 106kPa of air pressure.

When there are questions concerning measurement results:

In order to provide correlation data, the test shall be conducted under condition of $20 \pm 2^\circ\text{C}$ of temperature, 60 to 70% relative humidity and 86 to 106kPa of air pressure. Unless otherwise specified, all the tests are conducted under the "standard condition."

CHIP BEAD INDUCTORS FOR POWER LINE (FB SERIES M TYPE / T TYPE)

PRECAUTIONS

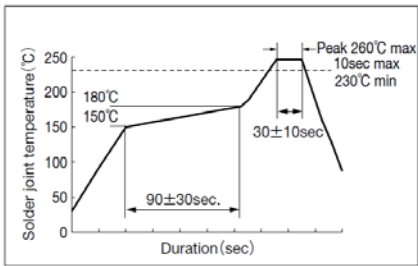
1. Circuit Design	
Precautions	<ul style="list-style-type: none"> ◆ Operating environment <ol style="list-style-type: none"> 1. The products listed in this catalogue are intended for use in general electronic equipment (e.g., AV equipment, OA equipment, home electric appliances, office equipment, information and communication equipment), general medical equipment, industrial equipment, and automotive interior applications, etc. <p>Please be sure to contact TAIYO YUDEN for further information before using the products for any equipment which may directly cause loss of human life or bodily injury (e.g., specially controlled medical equipment, transportation equipment including, without limitation, automotive powertrain control system, train control system, and ship control system, traffic signal equipment).</p> <p>Please do not incorporate our products into any equipment requiring high levels of safety and/or reliability (e.g., aerospace equipment, aviation equipment, nuclear control equipment, undersea equipment, military equipment, etc.).</p> <ul style="list-style-type: none"> ◆ Rated current <ol style="list-style-type: none"> 1. Rated current of this product is shown in this catalogue, but please be sure to have the base board designed with adequate inspection in case of the generation of heat becomes high within the rated current range when the base board is in high resistance or in bad heating conditions.
2. PCB Design	
Precautions	<ul style="list-style-type: none"> ◆ Land pattern design <ol style="list-style-type: none"> 1. Please refer to a recommended land pattern.
3. Considerations for automatic placement	
Precautions	<ul style="list-style-type: none"> ◆ Adjustment of mounting machine <ol style="list-style-type: none"> 1. Excessive impact load should not be imposed on the products when mounting onto the PC boards. 2. Mounting and soldering conditions should be checked beforehand.
Technical considerations	<ul style="list-style-type: none"> ◆ Adjustment of mounting machine <ol style="list-style-type: none"> 1. When installing products, care should be taken not to apply distortion stress as it may deform the products.
4. Soldering	
Precautions	<ul style="list-style-type: none"> ◆ Wave soldering <ol style="list-style-type: none"> 1. Please refer to the specifications in the catalog for a wave soldering. ◆ Reflow soldering <ol style="list-style-type: none"> 1. Please contact any of our offices for a reflow soldering, and refer to the recommended condition specified. ◆ Lead free soldering <ol style="list-style-type: none"> 1. When using products with lead free soldering, we request to use them after confirming adhesion, temperature of resistance to soldering heat, etc. sufficiently. ◆ Preheating when soldering <p>Heating : The temperature difference between soldering and remaining heat should not be greater than 150°C.</p> <p>Cooling : The temperature difference between the components and cleaning process should not be greater than 100°C.</p> ◆ Recommended conditions for using a soldering iron <p>Put the soldering iron on the land-pattern.</p> <p>Soldering iron's temperature – Below 350°C</p> <p>Duration – 3 seconds or less</p> <p>The soldering iron should not directly touch the inductor.</p>
Technical considerations	<ul style="list-style-type: none"> ◆ Wave, Reflow, Lead free soldering <ol style="list-style-type: none"> 1. If products are used beyond the range of the recommended conditions, heat stresses may deform the products, and consequently degrade the reliability of the products. <p>【Recommended reflow condition】</p>  ◆ Preheating when soldering <ol style="list-style-type: none"> 1. There is a case that products get damaged by a heat shock. ◆ Recommended conditions for using a soldering iron <ol style="list-style-type: none"> 1. If products are used beyond the range of the recommended conditions, heat stresses may deform the products, and consequently degrade the reliability of the products.

▶ This catalog contains the typical specification only due to the limitation of space. When you consider the purchase of our products, please check our specification. For details of each product (characteristics graph, reliability information, precautions for use, and so on), see our Web site (<http://www.ty-top.com/>).

5. Handling	
Precautions	<ul style="list-style-type: none"> ◆ Handling <ol style="list-style-type: none"> 1. Keep the inductors away from all magnets and magnetic objects. ◆ Setting PC boards <ol style="list-style-type: none"> 1. When setting a chip mounted base board, please make sure that there is no residual stress to the chip by distortion in the board or at screw part. ◆ Breakaway PC boards (splitting along perforations) <ol style="list-style-type: none"> 1. When splitting the PC board after mounting inductors, care should be taken not to give any stresses of deflection or twisting to the board. 2. Board separation should not be done manually, but by using the appropriate devices. ◆ Mechanical considerations <ol style="list-style-type: none"> 1. Please do not give the inductors any excessive mechanical shocks.
Technical considerations	<ul style="list-style-type: none"> ◆ Handling <ol style="list-style-type: none"> 1. There is a case that a characteristic varies with magnetic influence. ◆ Setting PC boards <ol style="list-style-type: none"> 1. There is a case that a characteristic varies with residual stress. ◆ Breakaway PC boards (splitting along perforations) <ol style="list-style-type: none"> 1. Planning pattern configurations and the position of products should be carefully performed to minimize stress. ◆ Mechanical considerations <ol style="list-style-type: none"> 1. There is a case to be damaged by a mechanical shock.
6. Storage conditions	
Precautions	<ul style="list-style-type: none"> ◆ Storage <ol style="list-style-type: none"> 1. To maintain the solderability of terminal electrodes and to keep the packing material in good condition, temperature and humidity in the storage area should be controlled. <ul style="list-style-type: none"> • Recommended conditions <li style="padding-left: 40px;">Ambient temperature -5~40°C <li style="padding-left: 40px;">Humidity Below 70% RH <p>The ambient temperature must be kept below 30°C. Even under ideal storage conditions, solderability of products electrodes may decrease as time passes.</p> <p>For this reason, inductors should be used within 6 months from the time of delivery.</p>
Technical considerations	<ul style="list-style-type: none"> ◆ Storage <ol style="list-style-type: none"> 1. Under a high temperature and humidity environment, problems such as reduced solderability caused by oxidation of terminal electrodes and deterioration of taping/packaging materials may take place.