

Notice for TAIYO YUDEN products

Please read this notice before using the TAIYO YUDEN products.

⚠️ REMINDERS

■ Product Information in this Catalog

Product information in this catalog is as of January 2021. All of the contents specified herein and production status of the products listed in this catalog are subject to change without notice due to technical improvement of our products, etc. Therefore, please check for the latest information carefully before practical application or use of our products.

Please note that TAIYO YUDEN shall not be in any way responsible for any damages and defects in products or equipment incorporating our products, which are caused under the conditions other than those specified in this catalog or individual product specification sheets.

■ Approval of Product Specifications

Please contact TAIYO YUDEN for further details of product specifications as the individual product specification sheets are available. When using our products, please be sure to approve our product specifications or make a written agreement on the product specification with TAIYO YUDEN in advance.

■ Pre-Evaluation in the Actual Equipment and Conditions

Please conduct validation and verification of our products in actual conditions of mounting and operating environment before using our products.

■ Limited Application

1. Equipment Intended for Use

The products listed in this catalog are intended for general-purpose and standard use in general electronic equipment (e.g., AV equipment, OA equipment, home electric appliances, office equipment, information and communication equipment including, without limitation, mobile phone, and PC) and other equipment specified in this catalog or the individual product specification sheets.

TAIYO YUDEN has the line-up of the products intended for use in automotive electronic equipment, telecommunications infrastructure and industrial equipment, or medical devices classified as GHTF Classes A to C (Japan Classes I to III). Therefore, when using our products for these equipment, please check available applications specified in this catalog or the individual product specification sheets and use the corresponding products.

2. Equipment Requiring Inquiry

Please be sure to contact TAIYO YUDEN for further information before using the products listed in this catalog for the following equipment (excluding intended equipment as specified in this catalog or the individual product specification sheets) which may cause loss of human life, bodily injury, serious property damage and/or serious public impact due to a failure or defect of the products and/or malfunction attributed thereto.

- (1) Transportation equipment (automotive powertrain control system, train control system, and ship control system, etc.)
- (2) Traffic signal equipment
- (3) Disaster prevention equipment, crime prevention equipment
- (4) Medical devices classified as GHTF Class C (Japan Class III)
- (5) Highly public information network equipment, data-processing equipment (telephone exchange, and base station, etc.)
- (6) Any other equipment requiring high levels of quality and/or reliability equal to the equipment listed above

3. Equipment Prohibited for Use

Please do not incorporate our products into the following equipment requiring extremely high levels of safety and/or reliability.

- (1) Aerospace equipment (artificial satellite, rocket, etc.)
- (2) Aviation equipment *¹
- (3) Medical devices classified as GHTF Class D (Japan Class IV), implantable medical devices *²

- (4) Power generation control equipment (nuclear power, hydroelectric power, thermal power plant control system, etc.)
- (5) Undersea equipment (submarine repeating equipment, underwater work equipment, etc.)
- (6) Military equipment
- (7) Any other equipment requiring extremely high levels of safety and/or reliability equal to the equipment listed above

*Notes:

1. There is a possibility that our products can be used only for aviation equipment that does not directly affect the safe operation of aircraft (e.g., in-flight entertainment, cabin light, electric seat, cooking equipment) if such use meets requirements specified separately by TAIYO YUDEN. Please be sure to contact TAIYO YUDEN for further information before using our products for such aviation equipment.
2. Implantable medical devices contain not only internal unit which is implanted in a body, but also external unit which is connected to the internal unit.

4. Limitation of Liability

Please note that unless you obtain prior written consent of TAIYO YUDEN, TAIYO YUDEN shall not be in any way responsible for any damages incurred by you or third parties arising from use of the products listed in this catalog for any equipment that is not intended for use by TAIYO YUDEN, or any equipment requiring inquiry to TAIYO YUDEN or prohibited for use by TAIYO YUDEN as described above.

■ Safety Design

When using our products for high safety and/or reliability-required equipment or circuits, please fully perform safety and/or reliability evaluation. In addition, please install (i) systems equipped with a protection circuit and a protection device and/or (ii) systems equipped with a redundant circuit or other system to prevent an unsafe status in the event of a single fault for a failsafe design to ensure safety.

■ Intellectual Property Rights

Information contained in this catalog is intended to convey examples of typical performances and/or applications of our products and is not intended to make any warranty with respect to the intellectual property rights or any other related rights of TAIYO YUDEN or any third parties nor grant any license under such rights.

■ Limited Warranty

Please note that the scope of warranty for our products is limited to the delivered our products themselves and TAIYO YUDEN shall not be in any way responsible for any damages resulting from a failure or defect in our products. Notwithstanding the foregoing, if there is a written agreement (e.g., supply and purchase agreement, quality assurance agreement) signed by TAIYO YUDEN and your company, TAIYO YUDEN will warrant our products in accordance with such agreement.

■ TAIYO YUDEN's Official Sales Channel

The contents of this catalog are applicable to our products which are purchased from our sales offices or authorized distributors (hereinafter "TAIYO YUDEN's official sales channel"). Please note that the contents of this catalog are not applicable to our products purchased from any seller other than TAIYO YUDEN's official sales channel.

■ Caution for Export

Some of our products listed in this catalog may require specific procedures for export according to "U.S. Export Administration Regulations", "Foreign Exchange and Foreign Trade Control Law" of Japan, and other applicable regulations. Should you have any questions on this matter, please contact our sales staff.

▶ This catalog contains the typical specification only due to the limitation of space. When you consider the purchase of our products, please check our product specification sheets. For details of each product (characteristics graph, reliability information, precautions for use, and so on), see our website (<http://www.ty-top.com/>).

Automotive Application Guide

We classify automotive electronic equipment into the following four application categories and set usable application categories for each of our products. When using our products for automotive electronic equipment, please be sure to check such application categories and use our products accordingly. Should you have any questions on this matter, please contact us.

Category	Automotive Electronic Equipment (Typical Example)
POWERTRAIN	<ul style="list-style-type: none"> • Engine ECU (Electronically Controlled Fuel Injector) • Cruise Control Unit • 4WS (4 Wheel Steering) • Transmission • Power Steering • HEV/PHV/EV Core Control (Battery, Inverter, DC-DC) • Automotive Locator (Car location information providing device), etc.
SAFETY	<ul style="list-style-type: none"> • ABS (Anti-Lock Brake System) • ESC (Electronic Stability Control) • Airbag • ADAS (Equipment that directly controls running, turning and stopping), etc.
BODY & CHASSIS	<ul style="list-style-type: none"> • Wiper • Automatic Door • Power Window • Keyless Entry System • Electric Door Mirror • Automobile Digital Mirror • Interior Lighting • Automobile Air Conditioning System • LED Headlight • TPMS (Tire Pressure Monitoring System) • Anti-Theft Device (Immobilizer), etc.
INFOTAINMENT	<ul style="list-style-type: none"> • Car Infotainment System • ITS/Telematics System • Instrument Cluster • ADAS (Sensor, Equipment that is not interlocked with safety equipment or powertrain) • Dashcam (genuine products for automotive manufacturer), etc.

MULTILAYER CERAMIC CAPACITORS

REFLOW

AEC-Q200

PART NUMBER

J	M	K	3	1	6	△	B	J	1	0	6	M	L	H	T	△
①	②	③	④	⑤	⑥	⑦	⑧	⑨	⑩	⑪	⑫					

△=Blank space

①Rated voltage

Code	Rated voltage[VDC]
A	4
J	6.3
L	10
E	16
T	25
G	35
U	50
H	100
Q	250
S	630

②Series name

Code	Series name
M	Multilayer ceramic capacitor
V	Multilayer ceramic capacitor for high frequency
W	LW reverse type multilayer capacitor

③End termination

Code	End termination
K	Plated
J	Soft Termination
S	Cu Internal Electrodes (For High Frequency)
F	High Reliability Application
R	High Reliability Application (Cu External Electrodes)

④Dimension (L×W)

Type	Dimensions (L×W) [mm]	EIA (inch)
063	0.6 × 0.3	0201
105	1.0 × 0.5	0402
	0.52 × 1.0 ※	0204
107	1.6 × 0.8	0603
	0.8 × 1.6 ※	0306
212	2.0 × 1.25	0805
	1.25 × 2.0 ※	0508
316	3.2 × 1.6	1206
325	3.2 × 2.5	1210
432	4.5 × 3.2	1812

Note : ※LW reverse type (□WK) only

⑤Dimension tolerance

Code	Type	L [mm]	W [mm]	T [mm]
△	ALL	Standard	Standard	Standard
A	063	0.6±0.05	0.3±0.05	0.3±0.05
	105	1.0±0.10	0.5±0.10	0.5±0.10
	107	1.6+0.15/-0.05	0.8+0.15/-0.05	0.8+0.15/-0.05
	212	2.0+0.15/-0.05	1.25+0.15/-0.05	0.85±0.10 1.25+0.15/-0.05
	316	3.2±0.20	1.6±0.20	1.6±0.20
	325	3.2±0.30	2.5±0.30	2.5±0.30
B	105	1.0+0.15/-0.05	0.5+0.15/-0.05	0.5+0.15/-0.05
	107	1.6+0.20/-0	0.8+0.20/-0	0.8+0.20/-0
	212	2.0+0.20/-0	1.25+0.20/-0	0.85±0.10 1.25+0.20/-0
	316	3.2±0.30	1.6±0.30	1.6±0.30
C	105	1.0+0.20/-0	0.5+0.20/-0	0.5+0.20/-0
	107	1.6+0.25/-0	0.8+0.25/-0	0.8+0.25/-0
	212	2.0+0.25/-0	1.25+0.25/-0	1.25+0.25/-0
K	212	2.0±0.15	1.25±0.15	0.85±0.15
	316	3.2±0.20	1.6±0.20	1.15±0.20 1.6±0.20
	325	3.2±0.50	2.5±0.30	2.5±0.30

Note: cf. STANDARD EXTERNAL DIMENSIONS

△= Blank space

⑥Temperature characteristics code

■High dielectric type

Code	Applicable standard	Temperature range [°C]	Ref. Temp. [°C]	Capacitance change	Capacitance tolerance	Tolerance code
BJ	EIA X5R	-55~+85	25	±15%	±10%	K
					±20%	M
C6	EIA X6S	-55~+105	25	±22%	±10%	K
					±20%	M
B7	EIA X7R	-55~+125	25	±15%	±10%	K
					±20%	M
C7	EIA X7S	-55~+125	25	±22%	±10%	K
					±20%	M
D7	EIA X7T	-55~+125	25	+22%/-33%	±10%	K
					±20%	M

► This catalog contains the typical specification only due to the limitation of space. When you consider the purchase of our products, please check our product specification sheets. For details of each product (characteristics graph, reliability information, precautions for use, and so on), see our website (<http://www.ty-top.com/>).

■ Temperature compensating type

Code	Applicable standard		Temperature range [°C]	Ref. Temp. [°C]	Capacitance change	Capacitance tolerance	Tolerance code
CG	JIS	CG	-55 ~ +125	20	0 ± 30 ppm/°C	± 0.1 pF	B
						± 0.25 pF	C
						± 0.5 pF	D
	EIA	COG		25		± 1 pF	F
						± 2%	G
						± 5%	J

⑦ Nominal capacitance

Code (example)	Nominal capacitance
0R5	0.5 pF
010	1 pF
100	10 pF
101	100 pF
102	1,000 pF
103	0.01 μF
104	0.1 μF
105	1.0 μF
106	10 μF
107	100 μF

Note : R=Decimal point

⑧ Capacitance tolerance

Code	Capacitance tolerance
A	± 0.05 pF
B	± 0.1 pF
C	± 0.25 pF
D	± 0.5 pF
G	± 2%
J	± 5%
K	± 10%
M	± 20%

⑨ Thickness

Code	Thickness [mm]
P	0.3
T	
V	0.5
C	0.7 (107 type or more)
A	0.8
D	0.85 (212 type or more)
F	1.15
G	1.25
L	1.6
N	1.9
M	2.5

⑩ Special code

Code	Special code
-	Standard
H	MLCC for Automotive
8	MLCC for Telecommunications infrastructure and Industrial equipment / Medical devices

⑪ Packaging

Code	Packaging
F	φ 178mm Taping (2mm pitch)
R	φ 178mm Embossed Taping (4mm pitch)
T	φ 178mm Taping (4mm pitch)
P	φ 178mm Taping (4mm pitch, 1000 pcs/reel) 325 type (Thickness code M)

⑫ Internal code

Code	Internal code
△	Standard

STANDARD EXTERNAL DIMENSIONS

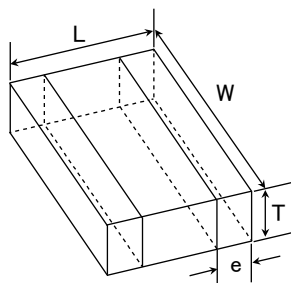
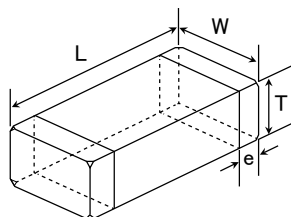

※ LW reverse type

Type(EIA)	Dimension [mm] (inch)				
	L	W	T	*1	e
□MK063(0201)	0.6±0.03 (0.024±0.001)	0.3±0.03 (0.012±0.001)	0.3±0.03 (0.012±0.001)	T	0.15±0.05 (0.006±0.002)
□MK105(0402) □MF105(0402)	1.0±0.05 (0.039±0.002)	0.5±0.05 (0.020±0.002)	0.5±0.05 (0.020±0.002)	V	0.25±0.10 (0.010±0.004)
□WK105(0204)※	0.52±0.05 (0.020±0.002)	1.0±0.05 (0.039±0.002)	0.3±0.05 (0.012±0.002)	P	0.18±0.08 (0.007±0.003)
□MK107(0603) □MF107(0603)	1.6±0.10 (0.063±0.004)	0.8±0.10 (0.031±0.004)	0.8±0.10 (0.031±0.004)	A	0.35±0.25 (0.014±0.010)
□MJ107(0603)	1.6±0.10 (0.063±0.004)	0.8±0.10 (0.031±0.004)	0.8±0.10 (0.031±0.004)	A	0.35+0.3/-0.25 (0.014+0.012/-0.010)
□VS107(0603)	1.6±0.10 (0.063±0.004)	0.8±0.10 (0.031±0.004)	0.7±0.10 (0.028±0.004)	C	0.35±0.25 (0.014±0.010)
□WK107(0306)※	0.8±0.10 (0.031±0.004)	1.6±0.10 (0.063±0.004)	0.5±0.05 (0.020±0.002)	V	0.25±0.15 (0.010±0.006)
□MK212(0805) □MF212(0805)	2.0±0.10 (0.079±0.004)	1.25±0.10 (0.049±0.004)	0.85±0.10 (0.033±0.004)	D	0.5±0.25 (0.020±0.010)
1.25±0.10 (0.049±0.004)			G		
□MJ212(0805)	2.0±0.10 (0.079±0.004)	1.25±0.10 (0.049±0.004)	0.85±0.10 (0.033±0.004)	D	0.5+0.35/-0.25 (0.020+0.014/-0.010)
1.25±0.10 (0.049±0.004)			G		
□VS212(0805)	2.0±0.10 (0.079±0.004)	1.25±0.10 (0.049±0.004)	0.85±0.10 (0.033±0.004)	D	0.5±0.25 (0.020±0.010)
□WK212(0508)※	1.25±0.15 (0.049±0.006)	2.0±0.15 (0.079±0.006)	0.85±0.10 (0.033±0.004)	D	0.3±0.2 (0.012±0.008)
□MK316(1206) □MF316(1206)	3.2±0.15 (0.126±0.006)	1.6±0.15 (0.063±0.006)	1.15±0.10 (0.045±0.004)	F	0.5+0.35/-0.25 (0.020+0.014/-0.010)
1.6±0.20 (0.063±0.008)			L		
□MJ316(1206)	3.2±0.15 (0.126±0.006)	1.6±0.15 (0.063±0.006)	1.15±0.10 (0.045±0.004)	F	0.6+0.4/-0.3 (0.024+0.016/-0.012)
1.6±0.20 (0.063±0.008)			L		
□MK325(1210) □MF325(1210)	3.2±0.30 (0.126±0.012)	2.5±0.20 (0.098±0.008)	1.15±0.10 (0.045±0.004)	F	0.6±0.3 (0.024±0.012)
1.9±0.20 (0.075±0.008)			N		
2.5±0.20 (0.098±0.008)					
□MJ325(1210)	3.2±0.30 (0.126±0.012)	2.5±0.20 (0.098±0.008)	1.9±0.20 (0.075±0.008)	N	0.6+0.4/-0.3 (0.024+0.016/-0.012)
2.5±0.20 (0.098±0.008)			M		
□MK432(1812)	4.5±0.40 (0.177±0.016)	3.2±0.30 (0.126±0.012)	2.5±0.20 (0.098±0.008)	M	0.9±0.6 (0.035±0.024)

Note : ※. LW reverse type, *1.Thickness code

CERAMIC CAPACITORS

AUTO

For Automotive Electronic Equipment
MULTILAYER CERAMIC CAPACITORS

► This catalog contains the typical specification only due to the limitation of space. When you consider the purchase of our products, please check our product specification sheets. For details of each product (characteristics graph, reliability information, precautions for use, and so on), see our website (<http://www.ty-top.com/>).

STANDARD QUANTITY

Type	EIA (inch)	Dimension		Standard quantity [pcs]	
		[mm]	Code	Paper tape	Embossed tape
063	0201	0.3	T	15000	—
105	0402	0.5	V	10000	—
	0204 ※	0.30	P		
107	0603	0.7	C	4000	—
		0.8	A		
		0.8	A	3000 (Soft Termination)	—
		0.8	A	—	3000 (Soft Termination)
	0306 ※	0.50	V	—	4000
212	0805	0.85	D	4000	—
		1.25	G	—	3000
		1.25	G	—	2000 (Soft Termination)
	0508 ※	0.85	D	4000	—
316	1206	1.15	F	—	3000
		1.6	L	—	2000
325	1210	1.15	F	—	2000
		1.9	N		
		2.5	M	—	500(T), 1000(P)
432	1812	2.5	M	—	500

Note : ※: LW Reverse type (□WK)

CERAMIC CAPACITORS
AUTO

For Automotive Electronic Equipment
 MULTILAYER CERAMIC CAPACITORS

► This catalog contains the typical specification only due to the limitation of space. When you consider the purchase of our products, please check our product specification sheets. For details of each product (characteristics graph, reliability information, precautions for use, and so on), see our website (<http://www.ty-top.com/>).

■ PART NUMBER

- All the Multilayer Ceramic Capacitors of the catalog lineup are RoHS compliant.
- Capacitance tolerance code is applied to □ of part number.
- All the Multilayer Ceramic Capacitors in the catalog lineup are applicable for reflow-soldering.

Notes)

- The exchange of individual specifications is necessary depending on your application and/or circuit condition. Please contact TAIYO YUDEN's official sales channel.
- For Automotive (AEC-Q200 Qualified) products for BODY & CHASSIS, and INFOTAINMENT. Please check "Automotive Application Guide" for further details before using the products.

< AEC-Q200 : AEC-Q200 qualified >

All the Multilayer Ceramic Capacitors for Automotive products are tested based on the test conditions and methods defined in AEC-Q200 by family item.

125°C products: AEC-Q200 Grade1 (we conduct the evaluation at the test condition of Grade1.)

105°C products: AEC-Q200 Grade2 (we conduct the evaluation at the test condition of Grade2.)

85°C products: AEC-Q200 Grade3 (we conduct the evaluation at the test condition of Grade3.)

Please consult with TAIYO YUDEN's official sales channel for the details of the product specifications and AEC-Q200 test results, etc.,

and please review and approve the product specifications before ordering.

- *1: For standard case size, please kindly refer to ④Dimension, ⑤Dimension tolerance, ⑨Thickness and STANDARD EXTERNAL DIMENSIONS.

Multilayer Ceramic Capacitors (High dielectric type)

● 063TYPE (Dimension:0.6×0.3mm JIS:1005 EIA:0402)

【Temperature Characteristic B7 : X7R(−55~+125°C)】 0.3mm thickness(T)

Part number 1	Part number 2	Rated voltage [V]	Temperature characteristics	Capacitance [F]	Capacitance tolerance [%]	tan δ [%]	HTLT	Thickness*1 [mm]	Note
							Rated voltage x %		
TMK063 B7101□PHFE		25	X7R	100 p	±10, ±20	3.5	200	0.3±0.03	
TMK063 B7151□PHFE			X7R	150 p	±10, ±20	3.5	200	0.3±0.03	
TMK063 B7221□PHFE			X7R	220 p	±10, ±20	3.5	200	0.3±0.03	
TMK063 B7331□PHFE			X7R	330 p	±10, ±20	3.5	200	0.3±0.03	
TMK063 B7471□PHFE			X7R	470 p	±10, ±20	3.5	200	0.3±0.03	
TMK063 B7102□PHFE			X7R	1000 p	±10, ±20	3.5	200	0.3±0.03	
TMK063 B7152□PHFE			X7R	1500 p	±10, ±20	5	200	0.3±0.03	
TMK063 B7222□PHFE			X7R	2200 p	±10, ±20	5	200	0.3±0.03	
TMK063 B7332□PHFE			X7R	3300 p	±10, ±20	5	200	0.3±0.03	
EMK063 B7101□PHFE			16	X7R	100 p	±10, ±20	3.5	200	0.3±0.03
EMK063 B7151□PHFE		X7R		150 p	±10, ±20	3.5	200	0.3±0.03	
EMK063 B7221□PHFE		X7R		220 p	±10, ±20	3.5	200	0.3±0.03	
EMK063 B7331□PHFE		X7R		330 p	±10, ±20	3.5	200	0.3±0.03	
EMK063 B7471□PHFE		X7R		470 p	±10, ±20	3.5	200	0.3±0.03	
EMK063 B7102□PHFE		X7R		1000 p	±10, ±20	3.5	200	0.3±0.03	
EMK063 B7152□PHFE		X7R		1500 p	±10, ±20	5	200	0.3±0.03	
EMK063 B7222□PHFE		X7R		2200 p	±10, ±20	5	200	0.3±0.03	
EMK063 B7332□PHFE		X7R		3300 p	±10, ±20	5	200	0.3±0.03	
LMK063 B7101□PHFE		10		X7R	100 p	±10, ±20	3.5	200	0.3±0.03
LMK063 B7151□PHFE			X7R	150 p	±10, ±20	3.5	200	0.3±0.03	
LMK063 B7221□PHFE			X7R	220 p	±10, ±20	3.5	200	0.3±0.03	
LMK063 B7331□PHFE			X7R	330 p	±10, ±20	3.5	200	0.3±0.03	
LMK063 B7471□PHFE			X7R	470 p	±10, ±20	3.5	200	0.3±0.03	
LMK063 B7102□PHFE			X7R	1000 p	±10, ±20	3.5	200	0.3±0.03	
LMK063 B7152□PHFE			X7R	1500 p	±10, ±20	5	200	0.3±0.03	
LMK063 B7222□PHFE			X7R	2200 p	±10, ±20	5	200	0.3±0.03	
LMK063 B7332□PHFE			X7R	3300 p	±10, ±20	5	200	0.3±0.03	
LMK063 B7472□PHFE			X7R	4700 p	±10, ±20	5	200	0.3±0.03	
LMK063 B7682□PHFE		X7R	6800 p	±10, ±20	5	200	0.3±0.03		
LMK063 B7103□PHFE		X7R	0.01 μ	±10, ±20	5	200	0.3±0.03		

► This catalog contains the typical specification only due to the limitation of space. When you consider the purchase of our products, please check our product specification sheets. For details of each product (characteristics graph, reliability information, precautions for use, and so on), see our website (<http://www.ty-top.com/>).

■ PART NUMBER

● 105TYPE (Dimension:1.0×0.5mm JIS:1005 EIA:0402)

【Temperature Characteristic BJ : X5R(−55~+85°C)】 0.5mm thickness (V)

Part number 1	Part number 2	Rated voltage [V]	Temperature characteristics	Capacitance [F]	Capacitance tolerance [%]	tan δ [%]	HTLT		Thickness*1 [mm]	Note
							Rated voltage x %			
UMK105 BJ471[VHF]		50	X5R	470 p	±10, ±20	2.5	200	0.5±0.05		
UMK105 BJ102[VHF]			X5R	1000 p	±10, ±20	2.5	200	0.5±0.05		
UMK105 BJ152[VHF]			X5R	1500 p	±10, ±20	2.5	200	0.5±0.05		
UMK105 BJ222[VHF]			X5R	2200 p	±10, ±20	2.5	200	0.5±0.05		
UMK105 BJ332[VHF]			X5R	3300 p	±10, ±20	2.5	200	0.5±0.05		
UMK105 BJ472[VHF]			X5R	4700 p	±10, ±20	2.5	200	0.5±0.05		
UMK105 BJ682[VHF]			X5R	6800 p	±10, ±20	2.5	150	0.5±0.05		
UMK105 BJ103[VHF]			X5R	0.01 μ	±10, ±20	3.5	200	0.5±0.05		
UMK105 BJ223[VHF]			X5R	0.022 μ	±10, ±20	5	200	0.5±0.05		
UMK105 BJ473[VHF]			X5R	0.047 μ	±10, ±20	5	200	0.5±0.05		
UMK105 BJ104[VHF]			X5R	0.1 μ	±10, ±20	10	150	0.5±0.05		
TMK105 BJ472[VHF]			25	X5R	4700 p	±10, ±20	2.5	200	0.5±0.05	
TMK105 BJ682[VHF]				X5R	6800 p	±10, ±20	2.5	200	0.5±0.05	
TMK105 BJ103[VHF]				X5R	0.01 μ	±10, ±20	3.5	200	0.5±0.05	
TMK105 BJ153[VHF]				X5R	0.015 μ	±10, ±20	3.5	200	0.5±0.05	
TMK105 BJ223[VHF]				X5R	0.022 μ	±10, ±20	3.5	200	0.5±0.05	
TMK105 BJ333[VHF]		X5R		0.033 μ	±10, ±20	3.5	150	0.5±0.05		
TMK105 BJ473[VHF]		X5R		0.047 μ	±10, ±20	3.5	150	0.5±0.05		
TMK105 BJ104[VHF]		X5R		0.1 μ	±10, ±20	5	150	0.5±0.05		
TMK105 BJ224[VHF]		X5R		0.22 μ	±10, ±20	10	150	0.5±0.05		
TMK105ABJ474[VHF]		X5R		0.47 μ	±10, ±20	10	150	0.5±0.10		
EMK105 BJ103[VHF]		16		X5R	0.01 μ	±10, ±20	3.5	200	0.5±0.05	
EMK105 BJ153[VHF]				X5R	0.015 μ	±10, ±20	3.5	200	0.5±0.05	
EMK105 BJ223[VHF]				X5R	0.022 μ	±10, ±20	3.5	200	0.5±0.05	
EMK105 BJ333[VHF]				X5R	0.033 μ	±10, ±20	3.5	150	0.5±0.05	
EMK105 BJ473[VHF]				X5R	0.047 μ	±10, ±20	3.5	150	0.5±0.05	
EMK105 BJ104[VHF]				X5R	0.1 μ	±10, ±20	5	150	0.5±0.05	
EMK105 BJ224[VHF]			X5R	0.22 μ	±10, ±20	10	150	0.5±0.05		
EMK105ABJ474[VHF]			X5R	0.47 μ	±10, ±20	10	150	0.5±0.10		
EMK105 BJ105[VHF]			X5R	1 μ	±10, ±20	10	150	0.5±0.05		
LMK105 BJ333[VHF]			10	X5R	0.033 μ	±10, ±20	3.5	150	0.5±0.05	
LMK105 BJ473[VHF]				X5R	0.047 μ	±10, ±20	3.5	150	0.5±0.05	
LMK105 BJ104[VHF]				X5R	0.1 μ	±10, ±20	5	150	0.5±0.05	
LMK105 BJ224[VHF]				X5R	0.22 μ	±10, ±20	5	150	0.5±0.05	
LMK105ABJ474[VHF]				X5R	0.47 μ	±10, ±20	10	150	0.5±0.10	
LMK105 BJ105[VHF]				X5R	1 μ	±10, ±20	10	150	0.5±0.05	
LMK105ABJ225[VHF]				X5R	2.2 μ	±10, ±20	10	150	0.5±0.10	
JMK105 BJ104[VHF]		6.3		X5R	0.1 μ	±10, ±20	5	150	0.5±0.05	
JMK105 BJ224[VHF]				X5R	0.22 μ	±10, ±20	5	150	0.5±0.05	
JMK105 BJ474[VHF]				X5R	0.47 μ	±10, ±20	10	150	0.5±0.05	
JMK105 BJ105[VHF]				X5R	1 μ	±10, ±20	10	150	0.5±0.05	
JMK105 BJ225[VHF]				X5R	2.2 μ	±10, ±20	10	150	0.5±0.05	
JMK105BBJ475MVHF				X5R	4.7 μ	±20	10	150	0.5+0.15/-0.05	
AMK105 BJ225[VHF]		4		X5R	2.2 μ	±10, ±20	10	150	0.5±0.05	
AMK105BBJ475MVHF				X5R	4.7 μ	±20	10	150	0.5+0.15/-0.05	

CERAMIC CAPACITORS

AUTO

For Automotive Electronic Equipment
MULTILAYER CERAMIC CAPACITORS (HIGH DIELECTRIC TYPE)

▶ This catalog contains the typical specification only due to the limitation of space. When you consider the purchase of our products, please check our product specification sheets. For details of each product (characteristics graph, reliability information, precautions for use, and so on), see our website (<http://www.ty-top.com/>).

【Temperature Characteristic B7 : X7R (−55~+125°C), D7 : X7T (−55~+125°C)】 0.5mm thickness (V)

Part number 1	Part number 2	Rated voltage [V]	Temperature characteristics	Capacitance [F]	Capacitance tolerance [%]	tan δ [%]	HTLT	Thickness*1 [mm]	Note	
							Rated voltage x %			
UMK105 B7221□VHF		50	X7R	220 p	±10, ±20	2.5	200	0.5±0.05		
UMK105 B7331□VHF			X7R	330 p	±10, ±20	2.5	200	0.5±0.05		
UMK105 B7471□VHF			X7R	470 p	±10, ±20	2.5	200	0.5±0.05		
UMK105 B7681□VHF			X7R	680 p	±10, ±20	2.5	200	0.5±0.05		
UMK105 B7102□VHF			X7R	1000 p	±10, ±20	2.5	200	0.5±0.05		
UMK105 B7152□VHF			X7R	1500 p	±10, ±20	2.5	200	0.5±0.05		
UMK105 B7222□VHF			X7R	2200 p	±10, ±20	2.5	200	0.5±0.05		
UMK105 B7332□VHF			X7R	3300 p	±10, ±20	2.5	200	0.5±0.05		
UMK105 B7472□VHF			X7R	4700 p	±10, ±20	2.5	150	0.5±0.05		
UMK105 B7682□VHF			X7R	6800 p	±10, ±20	2.5	150	0.5±0.05		
UMK105 B7103□VHF			X7R	0.01 μ	±10, ±20	3.5	150	0.5±0.05		
UMK105 B7153□VHFE			X7R	0.015 μ	±10, ±20	3.5	200	0.5±0.05		
UMK105 B7223□VHF			X7R	0.022 μ	±10, ±20	10	200	0.5±0.05		
UMK105 B7333□VHFE			X7R	0.033 μ	±10, ±20	3.5	150	0.5±0.05		
UMK105 B7473□VHF			X7R	0.047 μ	±10, ±20	10	200	0.5±0.05		
UMK105 B7104□VHF			X7R	0.1 μ	±10, ±20	10	150	0.5±0.05		
TMK105 B7472□VHF			25	X7R	4700 p	±10, ±20	2.5	200	0.5±0.05	
TMK105 B7682□VHF				X7R	6800 p	±10, ±20	2.5	200	0.5±0.05	
TMK105 B7103□VHF				X7R	0.01 μ	±10, ±20	3.5	200	0.5±0.05	
TMK105 B7153□VHF				X7R	0.015 μ	±10, ±20	3.5	150	0.5±0.05	
TMK105 B7223□VHF		X7R		0.022 μ	±10, ±20	3.5	150	0.5±0.05		
TMK105 B7333□VHF		X7R		0.033 μ	±10, ±20	3.5	150	0.5±0.05		
TMK105 B7473□VHF		X7R		0.047 μ	±10, ±20	3.5	150	0.5±0.05		
TMK105 B7104□VHF		X7R		0.1 μ	±10, ±20	10	150	0.5±0.05		
EMK105 B7103□VHF		16		X7R	0.01 μ	±10, ±20	3.5	200	0.5±0.05	
EMK105 B7153□VHF				X7R	0.015 μ	±10, ±20	3.5	150	0.5±0.05	
EMK105 B7223□VHF			X7R	0.022 μ	±10, ±20	3.5	150	0.5±0.05		
EMK105 B7333□VHF			X7R	0.033 μ	±10, ±20	3.5	150	0.5±0.05		
EMK105 B7473□VHF			X7R	0.047 μ	±10, ±20	3.5	150	0.5±0.05		
EMK105 B7104□VHF			X7R	0.1 μ	±10, ±20	5	150	0.5±0.05		
EMK105 B7224□VHF		10	X7R	0.22 μ	±10, ±20	10	150	0.5±0.05		
LMK105 B7473□VHF			X7R	0.047 μ	±10, ±20	3.5	150	0.5±0.05		
LMK105 B7104□VHF			X7R	0.1 μ	±10, ±20	5	150	0.5±0.05		
LMK105 B7224□VHF			X7R	0.22 μ	±10, ±20	10	150	0.5±0.05		
JMK105 B7104□VHF		6.3	X7R	0.1 μ	±10, ±20	5	150	0.5±0.05		
JMK105 B7224□VHF			X7R	0.22 μ	±10, ±20	10	150	0.5±0.05		
JMK105 B7474□VHF			X7R	0.47 μ	±10, ±20	10	150	0.5±0.05		
JMK105CD7105□VHF		4	X7T	1 μ	±10, ±20	10	150	0.5+0.20/-0		
AMK105 B7474□VHF			X7R	0.47 μ	±10, ±20	10	150	0.5±0.05		

► This catalog contains the typical specification only due to the limitation of space. When you consider the purchase of our products, please check our product specification sheets. For details of each product (characteristics graph, reliability information, precautions for use, and so on), see our website (<http://www.ty-top.com/>).

■ PART NUMBER

● 107TYPE (Dimension:1.6 × 0.8mm JIS:1608 EIA:0603)

【Temperature Characteristic BJ : X5R(−55~+85°C)】 0.8mm thickness(A)

Part number 1	Part number 2	Rated voltage [V]	Temperature characteristics	Capacitance [F]	Capacitance tolerance [%]	tan δ [%]	HTLT		Thickness*1 [mm]	Note
							Rated voltage x %			
UMK107 BJ104[AHT]		50	X5R	0.1 μ	±10, ±20	3.5	150	0.8±0.10		
UMK107 BJ224[AHT]			X5R	0.22 μ	±10, ±20	10	150	0.8±0.10		
UMK107 BJ474[AHT]			X5R	0.47 μ	±10, ±20	10	150	0.8±0.10		
UMK107ABJ105[AHT]			X5R	1 μ	±10, ±20	10	150	0.8+0.15/-0.05		
GMK107 BJ223[AHT]			X5R	0.022 μ	±10, ±20	2.5	200	0.8±0.10		
GMK107 BJ473[AHT]		35	X5R	0.047 μ	±10, ±20	3.5	200	0.8±0.10		
GMK107 BJ104[AHT]			X5R	0.1 μ	±10, ±20	3.5	150	0.8±0.10		
GMK107 BJ224[AHT]			X5R	0.22 μ	±10, ±20	10	150	0.8±0.10		
GMK107ABJ474[AHT]			X5R	0.47 μ	±10, ±20	10	150	0.8+0.15/-0.05		
GMK107 BJ105[AHT]			X5R	1 μ	±10, ±20	10	150	0.8±0.10		
TMK107 BJ223[AHT]		25	X5R	0.022 μ	±10, ±20	2.5	200	0.8±0.10		
TMK107 BJ473[AHT]			X5R	0.047 μ	±10, ±20	3.5	200	0.8±0.10		
TMK107 BJ104[AHT]			X5R	0.1 μ	±10, ±20	3.5	150	0.8±0.10		
TMK107 BJ224[AHT]			X5R	0.22 μ	±10, ±20	5	150	0.8±0.10		
TMK107 BJ474[AHT]			X5R	0.47 μ	±10, ±20	3.5	150	0.8±0.10		
TMK107 BJ105[AHT]		16	X5R	1 μ	±10, ±20	10	150	0.8±0.10		
TMK107BBJ225[AHT]			X5R	2.2 μ	±10, ±20	10	150	0.8+0.20/-0		
EMK107 BJ104[AHT]			X5R	0.1 μ	±10, ±20	3.5	150	0.8±0.10		
EMK107 BJ224[AHT]			X5R	0.22 μ	±10, ±20	5	150	0.8±0.10		
EMK107 BJ474[AHT]			X5R	0.47 μ	±10, ±20	3.5	150	0.8±0.10		
EMK107 BJ105[AHT]		10	X5R	1 μ	±10, ±20	5	150	0.8±0.10		
EMK107ABJ225[AHT]			X5R	2.2 μ	±10, ±20	10	150	0.8+0.15/-0.05		
EMK107BBJ475[AHT]			X5R	4.7 μ	±10, ±20	10	150	0.8+0.20/-0		
LМК107 BJ474[AHT]			X5R	0.47 μ	±10, ±20	3.5	150	0.8±0.10		
LМК107 BJ105[AHT]			X5R	1 μ	±10, ±20	5	150	0.8±0.10		
LМК107 BJ225[AHT]		6.3	X5R	2.2 μ	±10, ±20	10	150	0.8±0.10		
LМК107 BJ475[AHT]			X5R	4.7 μ	±10, ±20	10	150	0.8±0.10		
LМК107BBJ106MAHT			X5R	10 μ	±20	10	150	0.8+0.20/-0		
JMK107 BJ105[AHT]			X5R	1 μ	±10, ±20	5	150	0.8±0.10		
JMK107 BJ225[AHT]			X5R	2.2 μ	±10, ±20	10	150	0.8±0.10		
JMK107 BJ475[AHT]		4	X5R	4.7 μ	±10, ±20	10	150	0.8±0.10		
JMK107ABJ106[AHT]			X5R	10 μ	±10, ±20	10	150	0.8+0.15/-0.05		
AMK107ABJ106[AHT]			X5R	10 μ	±10, ±20	10	150	0.8+0.15/-0.05		
AMK107BBJ226MAHT			X5R	22 μ	±20	10	150	0.8+0.20/-0		

【Temperature Characteristic B7 : X7R(−55~+125°C), C7 : X7S(−55~+125°C), D7 : X7T(−55~+125°C)】 0.8mm thickness(A)

Part number 1	Part number 2	Rated voltage [V]	Temperature characteristics	Capacitance [F]	Capacitance tolerance [%]	tan δ [%]	HTLT		Thickness*1 [mm]	Note
							Rated voltage x %			
UMK107 B7102[AHT]		50	X7R	1000 p	±10, ±20	3.5	200	0.8±0.10		
UMK107 B7152[AHT]			X7R	1500 p	±10, ±20	3.5	200	0.8±0.10		
UMK107 B7222[AHT]			X7R	2200 p	±10, ±20	3.5	200	0.8±0.10		
UMK107 B7332[AHT]			X7R	3300 p	±10, ±20	3.5	200	0.8±0.10		
UMK107 B7472[AHT]			X7R	4700 p	±10, ±20	3.5	200	0.8±0.10		
UMK107 B7682[AHT]			X7R	6800 p	±10, ±20	3.5	200	0.8±0.10		
UMK107 B7103[AHT]			X7R	0.01 μ	±10, ±20	3.5	200	0.8±0.10		
UMK107 B7153[AHT]			X7R	0.015 μ	±10, ±20	3.5	200	0.8±0.10		
UMK107 B7223[AHT]			X7R	0.022 μ	±10, ±20	3.5	200	0.8±0.10		
UMK107 B7333[AHT]			X7R	0.033 μ	±10, ±20	3.5	200	0.8±0.10		
UMK107 B7473[AHT]			X7R	0.047 μ	±10, ±20	3.5	200	0.8±0.10		
UMK107 B7683[AHT]			X7R	0.068 μ	±10, ±20	3.5	150	0.8±0.10		
UMK107 B7104[AHT]			X7R	0.1 μ	±10, ±20	3.5	200	0.8±0.10		
UMK107AC7154[AHTE]			X7S	0.15 μ	±10, ±20	3.5	150	0.8+0.15/-0.05		
UMK107 C7224[AHTE]			X7S	0.22 μ	±10, ±20	3.5	150	0.8±0.10		
GMK107 B7473[AHT]			35	X7R	0.047 μ	±10, ±20	3.5	200	0.8±0.10	
GMK107 B7104[AHT]				X7R	0.1 μ	±10, ±20	3.5	150	0.8±0.10	
GMK107 B7224[AHT]				X7R	0.22 μ	±10, ±20	10	150	0.8±0.10	
GMK107 B7474[AHT]				X7R	0.47 μ	±10, ±20	10	150	0.8±0.10	
GMK107AB7105[AHT]				X7R	1 μ	±10, ±20	10	150	0.8+0.15/-0.05	
TMK107 B7223[AHT]		25	X7R	0.022 μ	±10, ±20	2.5	200	0.8±0.10		
TMK107 B7473[AHT]			X7R	0.047 μ	±10, ±20	3.5	200	0.8±0.10		
TMK107 B7104[AHT]			X7R	0.1 μ	±10, ±20	3.5	150	0.8±0.10		
TMK107 B7224[AHT]			X7R	0.22 μ	±10, ±20	10	150	0.8±0.10		
TMK107 B7474[AHT]			X7R	0.47 μ	±10, ±20	10	150	0.8±0.10		
TMK107AB7105[AHT]		16	X7R	1 μ	±10, ±20	10	150	0.8+0.15/-0.05		
EMK107 B7473[AHT]			X7R	0.047 μ	±10, ±20	3.5	200	0.8±0.10		
EMK107 B7104[AHT]			X7R	0.1 μ	±10, ±20	3.5	150	0.8±0.10		
EMK107 B7224[AHT]			X7R	0.22 μ	±10, ±20	5	150	0.8±0.10		
EMK107 B7474[AHT]			X7R	0.47 μ	±10, ±20	10	150	0.8±0.10		
EMK107 B7105[AHT]		10	X7R	1 μ	±10, ±20	10	150	0.8±0.10		
LМК107 B7224[AHT]			X7R	0.22 μ	±10, ±20	5	150	0.8±0.10		
LМК107 B7474[AHT]			X7R	0.47 μ	±10, ±20	3.5	150	0.8±0.10		
LМК107 B7105[AHT]			X7R	1 μ	±10, ±20	10	150	0.8±0.10		
LМК107BD7225[AHT]			X7T	2.2 μ	±10, ±20	10	200	0.8+0.20/-0		
JMK107 B7105[AHT]		6.3	X7R	1 μ	±10, ±20	10	150	0.8±0.10		
JMK107 B7225[AHTR]			X7R	2.2 μ	±10, ±20	10	150	0.8±0.10		

▶ This catalog contains the typical specification only due to the limitation of space. When you consider the purchase of our products, please check our product specification sheets. For details of each product (characteristics graph, reliability information, precautions for use, and so on), see our website (<http://www.ty-top.com/>).

CERAMIC CAPACITORS
 AUTO
 For Automotive Electronic Equipment
 MULTILAYER CERAMIC CAPACITORS (HIGH DIELECTRIC TYPE)

■ PART NUMBER

● 212TYPE (Dimension:2.0×1.25mm JIS:2012 EIA:0805)

【Temperature Characteristic BJ : X5R(-55~+85°C)】 1.25mm thickness (G)

Part number 1	Part number 2	Rated voltage [V]	Temperature characteristics	Capacitance [F]	Capacitance tolerance [%]	tan δ [%]	HTLT		Thickness*1 [mm]	Note
							Rated voltage x %			
UMK212 BJ104□GHT		50	X5R	0.1 μ	±10, ±20	3.5	200	1.25±0.10		
UMK212 BJ224□GHT			X5R	0.22 μ	±10, ±20	3.5	200	1.25±0.10		
UMK212 BJ474□GHT			X5R	0.47 μ	±10, ±20	3.5	150	1.25±0.10		
UMK212 BJ105□GHT			X5R	1 μ	±10, ±20	5	150	1.25±0.10		
GMK212 BJ104□GHT		35	X5R	0.1 μ	±10, ±20	3.5	200	1.25±0.10		
GMK212 BJ224□GHT			X5R	0.22 μ	±10, ±20	3.5	150	1.25±0.10		
GMK212 BJ474□GHT			X5R	0.47 μ	±10, ±20	3.5	150	1.25±0.10		
GMK212 BJ105□GHT			X5R	1 μ	±10, ±20	5	150	1.25±0.10		
GMK212BBJ225□GHT			X5R	2.2 μ	±10, ±20	10	150	1.25+0.20/-0		
TMK212 BJ104□GHT		25	X5R	0.1 μ	±10, ±20	3.5	200	1.25±0.10		
TMK212 BJ224□GHT			X5R	0.22 μ	±10, ±20	3.5	150	1.25±0.10		
TMK212 BJ474□GHT			X5R	0.47 μ	±10, ±20	3.5	200	1.25±0.10		
TMK212 BJ105□GHT			X5R	1 μ	±10, ±20	3.5	150	1.25±0.10		
TMK212 BJ225□GHT			X5R	2.2 μ	±10, ±20	5	150	1.25±0.10		
TMK212BBJ475□GHT			X5R	4.7 μ	±10, ±20	10	150	1.25+0.20/-0		
TMK212BBJ106□GHT			X5R	10 μ	±10, ±20	10	150	1.25+0.20/-0		
EMK212 BJ105□GHT		16	X5R	1 μ	±10, ±20	3.5	150	1.25±0.10		
EMK212 BJ225□GHT			X5R	2.2 μ	±10, ±20	5	150	1.25±0.10		
EMK212ABJ475□GHT			X5R	4.7 μ	±10, ±20	10	150	1.25+0.15/-0.05		
EMK212BBJ106□GHT			X5R	10 μ	±10, ±20	10	150	1.25+0.20/-0		
LMK212 BJ225□GHT		10	X5R	2.2 μ	±10, ±20	5	200	1.25±0.10		
LMK212ABJ475□GHT			X5R	4.7 μ	±10, ±20	10	150	1.25+0.15/-0.05		
LMK212ABJ106□GHT			X5R	10 μ	±10, ±20	10	150	1.25+0.15/-0.05		
JMK212ABJ475□GHT			X5R	4.7 μ	±10, ±20	5	200	1.25+0.15/-0.05		
JMK212ABJ106□GHT		6.3	X5R	10 μ	±10, ±20	10	150	1.25+0.15/-0.05		
JMK212BBJ226MGHT			X5R	22 μ	±20	10	150	1.25+0.20/-0		
AMK212ABJ226MGHT		4	X5R	22 μ	±20	10	150	1.25+0.15/-0.05		
AMK212BBJ476MGHT			X5R	47 μ	±20	10	150	1.25+0.20/-0		

【Temperature Characteristic BJ : X5R(-55~+85°C)】 0.85mm thickness (D)

Part number 1	Part number 2	Rated voltage [V]	Temperature characteristics	Capacitance [F]	Capacitance tolerance [%]	tan δ [%]	HTLT		Thickness*1 [mm]	Note
							Rated voltage x %			
EMK212 BJ105□DHT		16	X5R	1 μ	±10, ±20	5	200	0.85±0.10		
EMK212ABJ225□DHT			X5R	2.2 μ	±10, ±20	5	150	0.85±0.10		
EMK212BBJ475□DHT			X5R	4.7 μ	±10, ±20	10	150	0.85±0.10		

【Temperature Characteristic B7 : X7R(-55~+125°C)】 1.25mm thickness (G)

Part number 1	Part number 2	Rated voltage [V]	Temperature characteristics	Capacitance [F]	Capacitance tolerance [%]	tan δ [%]	HTLT		Thickness*1 [mm]	Note
							Rated voltage x %			
UMK212 B7103□GHT		50	X7R	0.01 μ	±10, ±20	3.5	200	1.25±0.10		
UMK212 B7153□GHT			X7R	0.015 μ	±10, ±20	2.5	200	1.25±0.10		
UMK212 B7223□GHT			X7R	0.022 μ	±10, ±20	3.5	200	1.25±0.10		
UMK212 B7333□GHT			X7R	0.033 μ	±10, ±20	3.5	200	1.25±0.10		
UMK212 B7473□GHT			X7R	0.047 μ	±10, ±20	3.5	200	1.25±0.10		
UMK212 B7683□GHT			X7R	0.068 μ	±10, ±20	3.5	200	1.25±0.10		
UMK212 B7104□GHT			X7R	0.1 μ	±10, ±20	3.5	200	1.25±0.10		
UMK212BB7154□GHTE			X7R	0.15 μ	±10, ±20	3.5	200	1.25+0.2/-0		
UMK212 B7224□GHT			X7R	0.22 μ	±10, ±20	3.5	150	1.25±0.10		
UMK212BC7334□GHTE			X7S	0.33 μ	±10, ±20	3.5	150	1.25+0.2/-0		
UMK212 C7474□GHTE			X7S	0.47 μ	±10, ±20	3.5	150	1.25±0.10		
UMK212CC7684□GHTE			X7S	0.68 μ	±10, ±20	3.5	150	1.25+0.25/-0		
UMK212 B7105□GHT			X7R	1 μ	±10, ±20	10	150	1.25±0.10		
GMK212 B7224□GHT			35	X7R	0.22 μ	±10, ±20	3.5	150	1.25±0.10	
GMK212 B7105□GHT				X7R	1 μ	±10, ±20	10	150	1.25±0.10	
TMK212 B7224□GHT			25	X7R	0.22 μ	±10, ±20	3.5	150	1.25±0.10	
TMK212 B7334□GHT		X7R		0.33 μ	±10, ±20	3.5	200	1.25±0.10		
TMK212 B7474□GHT		X7R		0.47 μ	±10, ±20	3.5	150	1.25±0.10		
TMK212 B7105□GHTR		X7R		1 μ	±10, ±20	10	150	1.25±0.10		
TMK212 B7225□GHT		16	X7R	2.2 μ	±10, ±20	10	150	1.25±0.10		
EMK212 B7224□GHT			X7R	0.22 μ	±10, ±20	3.5	200	1.25±0.10		
EMK212 B7334□GHT			X7R	0.33 μ	±10, ±20	3.5	200	1.25±0.10		
EMK212 B7474□GHT			X7R	0.47 μ	±10, ±20	3.5	200	1.25±0.10		
EMK212 B7105□GHTR		10	X7R	1 μ	±10, ±20	10	150	1.25±0.10		
EMK212 B7225□GHT			X7R	2.2 μ	±10, ±20	10	150	1.25±0.10		
EMK212AB7475□GHT			X7R	4.7 μ	±10, ±20	10	150	1.25+0.15/-0.05		
LMK212 B7105□GHTR			6.3	X7R	1 μ	±10, ±20	10	150	1.25±0.10	
LMK212 B7225□GHT		X7R		2.2 μ	±10, ±20	10	150	1.25±0.10		
LMK212 B7475□GHT		X7R		4.7 μ	±10, ±20	10	150	1.25±0.10		
JMK212 B7475□GHT		X7R		4.7 μ	±10, ±20	10	150	1.25±0.10		
JMK212AB7106□GHT			X7R	10 μ	±10, ±20	10	150	1.25+0.15/-0.05		

▶ This catalog contains the typical specification only due to the limitation of space. When you consider the purchase of our products, please check our product specification sheets. For details of each product (characteristics graph, reliability information, precautions for use, and so on), see our website (<http://www.ty-top.com/>).

PART NUMBER

● 316TYPE (Dimension:3.2 × 1.6mm JIS:3216 EIA:1206)

【Temperature Characteristic BJ : X5R(−55~+85°C)】 1.6mm thickness(L)

Part number 1	Part number 2	Rated voltage [V]	Temperature characteristics	Capacitance [F]	Capacitance tolerance [%]	tan δ [%]	HTLT		Thickness*1 [mm]	Note
							Rated voltage x %			
UMK316 BJ474□LHT		50	X5R	0.47 μ	±10, ±20	3.5	200	1.6±0.20		
UMK316 BJ105□LHT			X5R	1 μ	±10, ±20	3.5	200	1.6±0.20		
UMK316 BJ225□LHT			X5R	2.2 μ	±10, ±20	10	150	1.6±0.20		
UMK316ABJ475□LHT			X5R	4.7 μ	±10, ±20	10	150	1.6±0.20		
GMK316 BJ105□LHT		35	X5R	1 μ	±10, ±20	3.5	200	1.6±0.20		
GMK316 BJ225□LHT			X5R	2.2 μ	±10, ±20	10	150	1.6±0.20		
GMK316 BJ475□LHT			X5R	4.7 μ	±10, ±20	10	150	1.6±0.20		
GMK316BBJ106□LHT			X5R	10 μ	±10, ±20	10	150	1.6±0.30		
TMK316 BJ225□LHT		25	X5R	2.2 μ	±10, ±20	3.5	200	1.6±0.20		
TMK316 BJ475□LHT			X5R	4.7 μ	±10, ±20	5	150	1.6±0.20		
TMK316 BJ106□LHT			X5R	10 μ	±10, ±20	5	150	1.6±0.20		
EMK316 BJ225□LHT			X5R	2.2 μ	±10, ±20	3.5	200	1.6±0.20		
EMK316 BJ475□LHT		16	X5R	4.7 μ	±10, ±20	5	150	1.6±0.20		
EMK316 BJ106□LHT			X5R	10 μ	±10, ±20	5	150	1.6±0.20		
EMK316BBJ226MLHT			X5R	22 μ	±20	10	150	1.6±0.30		
LMK316 BJ475□LHT			X5R	4.7 μ	±10, ±20	5	150	1.6±0.20		
LMK316 BJ106□LHT		10	X5R	10 μ	±10, ±20	5	150	1.6±0.20		
LMK316ABJ226□LHT			X5R	22 μ	±10, ±20	10	150	1.6±0.20		
JMK316 BJ106□LHT			X5R	10 μ	±10, ±20	5	200	1.6±0.20		
JMK316ABJ226□LHT			X5R	22 μ	±10, ±20	10	150	1.6±0.20		
JMK316ABJ476MLHT		6.3	X5R	47 μ	±20	10	150	1.6±0.20		
			X5R	47 μ	±20	10	150	1.6±0.20		

【Temperature Characteristic B7 : X7R(−55~+125°C), C7 : X7S(−55~+125°C)】 1.6mm thickness(L)

Part number 1	Part number 2	Rated voltage [V]	Temperature characteristics	Capacitance [F]	Capacitance tolerance [%]	tan δ [%]	HTLT		Thickness*1 [mm]	Note
							Rated voltage x %			
UMK316 B7473□LHT		50	X7R	0.047 μ	±10, ±20	3.5	200	1.6±0.20		
UMK316 B7683□LHT			X7R	0.068 μ	±10, ±20	2.5	200	1.6±0.20		
UMK316 B7104□LHT			X7R	0.1 μ	±10, ±20	3.5	200	1.6±0.20		
UMK316 B7154□LHT			X7R	0.15 μ	±10, ±20	3.5	200	1.6±0.20		
UMK316 B7224□LHT			X7R	0.22 μ	±10, ±20	3.5	200	1.6±0.20		
UMK316 B7334□LHT			X7R	0.33 μ	±10, ±20	3.5	200	1.6±0.20		
UMK316 B7474□LHT			X7R	0.47 μ	±10, ±20	3.5	200	1.6±0.20		
UMK316 B7105□LHT			X7R	1 μ	±10, ±20	3.5	200	1.6±0.20		
UMK316BC7155□LHTE			X7S	1.5 μ	±10, ±20	3.5	150	1.6±0.30		
UMK316 B7225□LHT			X7R	2.2 μ	±10, ±20	10	150	1.6±0.20		
UMK316AC7475□LHTE			X7S	4.7 μ	±10, ±20	2.5	150	1.6±0.20		
GMK316 B7105□LHT			35	X7R	1 μ	±10, ±20	3.5	200	1.6±0.20	
GMK316 B7225□LHT				X7R	2.2 μ	±10, ±20	10	150	1.6±0.20	
GMK316AB7475□LHT				X7R	4.7 μ	±10, ±20	10	150	1.6±0.20	
TMK316 B7105□LHT		25	X7R	1 μ	±10, ±20	3.5	200	1.6±0.20		
TMK316 B7225□LHT			X7R	2.2 μ	±10, ±20	3.5	200	1.6±0.20		
TMK316AB7475□LHT			X7R	4.7 μ	±10, ±20	10	150	1.6±0.20		
TMK316AB7106□LHT			X7R	10 μ	±10, ±20	10	150	1.6±0.20		
EMK316 B7225□LHT		16	X7R	2.2 μ	±10, ±20	3.5	200	1.6±0.20		
EMK316AB7475□LHT			X7R	4.7 μ	±10, ±20	10	150	1.6±0.20		
EMK316AB7106□LHT			X7R	10 μ	±10, ±20	10	150	1.6±0.20		
LMK316 B7475□LHT		10	X7R	4.7 μ	±10, ±20	5	150	1.6±0.20		
LMK316AB7106□LHT			X7R	10 μ	±10, ±20	10	150	1.6±0.20		
JMK316AB7106□LHT		6.3	X7R	10 μ	±10, ±20	10	150	1.6±0.20		
JMK316AB7226□LHT			X7R	22 μ	±10, ±20	10	150	1.6±0.20		
AMK316AB7226□LHT		4	X7R	22 μ	±10, ±20	10	150	1.6±0.20		
AMK316AC7476MLHT			X7S	47 μ	±20	10	150	1.6±0.20		

▶ This catalog contains the typical specification only due to the limitation of space. When you consider the purchase of our products, please check our product specification sheets. For details of each product (characteristics graph, reliability information, precautions for use, and so on), see our website (<http://www.ty-top.com/>).

CERAMIC CAPACITORS

AUTO

For Automotive Electronic Equipment
MULTILAYER CERAMIC CAPACITORS (HIGH DIELECTRIC TYPE)

■ PART NUMBER

● 325TYPE (Dimension:3.2×2.5mm JIS:3225 EIA:1210)

【Temperature Characteristic BJ : X5R(−55~+85°C)】 2.5mm thickness(M)

Part number 1	Part number 2	Rated voltage [V]	Temperature characteristics	Capacitance [F]	Capacitance tolerance [%]	tan δ [%]	HTLT		Thickness*1 [mm]	Note
							Rated voltage x %			
UMK325 BJ106□MHP		50	X5R	10 μ	±10, ±20	5	150		2.5±0.20	
GMK325 BJ106□MHP		35	X5R	10 μ	±10, ±20	5	150		2.5±0.20	
TMK325 BJ106□MHP		25	X5R	10 μ	±10, ±20	5	150		2.5±0.20	
EMK325 BJ226□MHP		16	X5R	22 μ	±10, ±20	5	150		2.5±0.20	
EMK325ABJ476□MHP			X5R	47 μ	±10, ±20	10	150		2.5±0.30	
LMK325 BJ226□MHP		10	X5R	22 μ	±10, ±20	5	150		2.5±0.20	
LMK325 BJ476□MHP			X5R	47 μ	±10, ±20	10	150		2.5±0.20	
JMK325 BJ476□MHP		6.3	X5R	47 μ	±10, ±20	10	150		2.5±0.20	

【Temperature Characteristic BJ : X5R(−55~+85°C)】 1.9mm thickness(N)

Part number 1	Part number 2	Rated voltage [V]	Temperature characteristics	Capacitance [F]	Capacitance tolerance [%]	tan δ [%]	HTLT		Thickness*1 [mm]	Note
							Rated voltage x %			
UMK325 BJ475□NHHT		50	X5R	4.7 μ	±10, ±20	10	150		1.9±0.20	
GMK325 BJ225MNHT		35	X5R	2.2 μ	±20	3.5	200		1.9±0.20	
GMK325 BJ475□NHHT			X5R	4.7 μ	±10, ±20	10	150		1.9±0.20	
TMK325 BJ475□NHHT		25	X5R	4.7 μ	±10, ±20	10	150		1.9±0.20	
EMK325 BJ475MNHT		16	X5R	4.7 μ	±20	3.5	200		1.9±0.20	
EMK325 BJ106□NHHT			X5R	10 μ	±10, ±20	5	150		1.9±0.20	

【Temperature Characteristic B7 : X7R(−55~+125°C)】 2.5mm thickness(M)

Part number 1	Part number 2	Rated voltage [V]	Temperature characteristics	Capacitance [F]	Capacitance tolerance [%]	tan δ [%]	HTLT		Thickness*1 [mm]	Note
							Rated voltage x %			
UMK325 B7225□MHP		50	X7R	2.2 μ	±10, ±20	3.5	200		2.5±0.20	
UMK325 B7335□MHP			X7R	3.3 μ	±10, ±20	3.5	200		2.5±0.20	
UMK325 B7475□MHP			X7R	4.7 μ	±10, ±20	5	150		2.5±0.20	
UMK325AB7106□MHP			X7R	10 μ	±10, ±20	10	150		2.5±0.30	
GMK325AB7106□MHP		35	X7R	10 μ	±10, ±20	10	150		2.5±0.30	
TMK325 B7335□MHP		25	X7R	3.3 μ	±10, ±20	3.5	200		2.5±0.20	
TMK325AB7106□MHPR			X7R	10 μ	±10, ±20	10	150		2.5±0.30	
TMK325 B7226□MHP			X7R	22 μ	±10, ±20	10	150		2.5±0.20	
EMK325 B7226□MHP		16	X7R	22 μ	±10, ±20	10	150		2.5±0.20	
LMK325 B7226□MHP		10	X7R	22 μ	±10, ±20	10	150		2.5±0.20	
JMK325 B7226□MHPR		6.3	X7R	22 μ	±10, ±20	10	150		2.5±0.20	
JMK325 B7476□MHPR			X7R	47 μ	±10, ±20	10	150		2.5±0.20	

【Temperature Characteristic B7 : X7R(−55~+125°C)】 1.9mm thickness(N)

Part number 1	Part number 2	Rated voltage [V]	Temperature characteristics	Capacitance [F]	Capacitance tolerance [%]	tan δ [%]	HTLT		Thickness*1 [mm]	Note
							Rated voltage x %			
UMK325 B7105□NHHT		50	X7R	1 μ	±10, ±20	3.5	200		1.9±0.20	
GMK325 B7225□NHHT		35	X7R	2.2 μ	±10, ±20	3.5	200		1.9±0.20	
GMK325 B7475□NHTR			X7R	4.7 μ	±10, ±20	10	150		1.9±0.20	
TMK325 B7475□NHHT		25	X7R	4.7 μ	±10, ±20	10	150		1.9±0.20	
EMK325 B7475□NHHT		16	X7R	4.7 μ	±10, ±20	3.5	150		1.9±0.20	
EMK325 B7106□NHTR			X7R	10 μ	±10, ±20	10	150		1.9±0.20	

▶ This catalog contains the typical specification only due to the limitation of space. When you consider the purchase of our products, please check our product specification sheets. For details of each product (characteristics graph, reliability information, precautions for use, and so on), see our website (<http://www.ty-top.com/>).

CERAMIC CAPACITORS
 AUTO
 For Automotive Electronic Equipment
 MULTILAYER CERAMIC CAPACITORS (HIGH DIELECTRIC TYPE)

Multilayer Ceramic Capacitors (Temperature compensating type)

● 063TYPE (Dimension:0.6×0.3mm JIS:0603 EIA:0201)

[Temperature Characteristic CG : CG/C0G(-55~+125°C)] 0.3mm thickness(T)

Part number 1	Part number 2	Rated voltage [V]	Temperature characteristics		Capacitance [F]	Capacitance tolerance	Q [at 1MHz] (Min)	HTLT	Thickness*1 [mm]	Note	
								Rated voltage x %			
UMK063 CG0R5CTHF		50	CG	C0G	0.5 p	±0.25pF	410	200	0.3±0.03		
UMK063 CG010CTHF			CG	C0G	1 p	±0.25pF	420	200	0.3±0.03		
UMK063 CG1R5CTHF			CG	C0G	1.5 p	±0.25pF	430	200	0.3±0.03		
UMK063 CG020CTHF			CG	C0G	2 p	±0.25pF	440	200	0.3±0.03		
UMK063 CG030CTHF			CG	C0G	3 p	±0.25pF	460	200	0.3±0.03		
UMK063 CG040CTHF			CG	C0G	4 p	±0.25pF	480	200	0.3±0.03		
UMK063 CG050CTHF			CG	C0G	5 p	±0.25pF	500	200	0.3±0.03		
UMK063 CG060DTHF			CG	C0G	6 p	±0.5pF	520	200	0.3±0.03		
UMK063 CG070DTHF			CG	C0G	7 p	±0.5pF	540	200	0.3±0.03		
UMK063 CG080DTHF			CG	C0G	8 p	±0.5pF	560	200	0.3±0.03		
UMK063 CG090DTHF			CG	C0G	9 p	±0.5pF	580	200	0.3±0.03		
UMK063 CG100DTHF			CG	C0G	10 p	±0.5pF	600	200	0.3±0.03		
UMK063 CG120JTHF			CG	C0G	12 p	±5%	640	200	0.3±0.03		
UMK063 CG150JTHF			CG	C0G	15 p	±5%	700	200	0.3±0.03		
UMK063 CG180JTHF			CG	C0G	18 p	±5%	760	200	0.3±0.03		
UMK063 CG220JTHF			CG	C0G	22 p	±5%	840	200	0.3±0.03		
UMK063 CG270JTHF			CG	C0G	27 p	±5%	940	200	0.3±0.03		
UMK063 CG330JTHF			CG	C0G	33 p	±5%	1000	200	0.3±0.03		
UMK063 CG390JTHF			CG	C0G	39 p	±5%	1000	200	0.3±0.03		
UMK063 CG470JTHF			CG	C0G	47 p	±5%	1000	200	0.3±0.03		
UMK063 CG560JTHF			CG	C0G	56 p	±5%	1000	200	0.3±0.03		
UMK063 CG680JTHF			CG	C0G	68 p	±5%	1000	200	0.3±0.03		
UMK063 CG820JTHF			CG	C0G	82 p	±5%	1000	200	0.3±0.03		
UMK063 CG101JTHF			CG	C0G	100 p	±5%	1000	200	0.3±0.03		
UMK063 CG121JTHF			CG	C0G	120 p	±5%	1000	200	0.3±0.03		
UMK063 CG151JTHF			CG	C0G	150 p	±5%	1000	200	0.3±0.03		
UMK063 CG181JTHF			CG	C0G	180 p	±5%	1000	200	0.3±0.03		
UMK063 CG221JTHF			CG	C0G	220 p	±5%	1000	200	0.3±0.03		
TMK063 CG121JTHF			25	CG	C0G	120 p	±5%	1000	200	0.3±0.03	
TMK063 CG151JTHF				CG	C0G	150 p	±5%	1000	200	0.3±0.03	
TMK063 CG181JTHF				CG	C0G	180 p	±5%	1000	200	0.3±0.03	
TMK063 CG221JTHF				CG	C0G	220 p	±5%	1000	200	0.3±0.03	

● 105TYPE (Dimension:1.0×0.5mm JIS:1005 EIA:0402)

[Temperature Characteristic CG : CG/C0G(-55~+125°C)] 0.5mm thickness(V)

Part number 1	Part number 2	Rated voltage [V]	Temperature characteristics		Capacitance [F]	Capacitance tolerance	Q [at 1MHz] (Min)	HTLT	Thickness*1 [mm]	Note
								Rated voltage x %		
UMK105 CG0R5CVHF		50	CG	C0G	0.5 p	±0.25pF	410	200	0.5±0.05	
UMK105 CG010CVHF			CG	C0G	1 p	±0.25pF	420	200	0.5±0.05	
UMK105 CG1R5CVHF			CG	C0G	1.5 p	±0.25pF	430	200	0.5±0.05	
UMK105 CG020CVHF			CG	C0G	2 p	±0.25pF	440	200	0.5±0.05	
UMK105 CG030CVHF			CG	C0G	3 p	±0.25pF	460	200	0.5±0.05	
UMK105 CG040CVHF			CG	C0G	4 p	±0.25pF	480	200	0.5±0.05	
UMK105 CG050CVHF			CG	C0G	5 p	±0.25pF	500	200	0.5±0.05	
UMK105 CG060DVHF			CG	C0G	6 p	±0.5pF	520	200	0.5±0.05	
UMK105 CG070DVHF			CG	C0G	7 p	±0.5pF	540	200	0.5±0.05	
UMK105 CG080DVHF			CG	C0G	8 p	±0.5pF	560	200	0.5±0.05	
UMK105 CG090DVHF			CG	C0G	9 p	±0.5pF	580	200	0.5±0.05	
UMK105 CG100DVHF			CG	C0G	10 p	±0.5pF	600	200	0.5±0.05	
UMK105 CG120JVHF			CG	C0G	12 p	±5%	640	200	0.5±0.05	
UMK105 CG150JVHF			CG	C0G	15 p	±5%	700	200	0.5±0.05	
UMK105 CG180JVHF			CG	C0G	18 p	±5%	760	200	0.5±0.05	
UMK105 CG220JVHF			CG	C0G	22 p	±5%	840	200	0.5±0.05	
UMK105 CG270JVHF			CG	C0G	27 p	±5%	940	200	0.5±0.05	
UMK105 CG330JVHF			CG	C0G	33 p	±5%	1000	200	0.5±0.05	
UMK105 CG390JVHF			CG	C0G	39 p	±5%	1000	200	0.5±0.05	
UMK105 CG470JVHF			CG	C0G	47 p	±5%	1000	200	0.5±0.05	
UMK105 CG560JVHF			CG	C0G	56 p	±5%	1000	200	0.5±0.05	
UMK105 CG680JVHF			CG	C0G	68 p	±5%	1000	200	0.5±0.05	
UMK105 CG820JVHF			CG	C0G	82 p	±5%	1000	200	0.5±0.05	
UMK105 CG101JVHF			CG	C0G	100 p	±5%	1000	200	0.5±0.05	
UMK105 CG121JVHF			CG	C0G	120 p	±5%	1000	200	0.5±0.05	
UMK105 CG151JVHF			CG	C0G	150 p	±5%	1000	200	0.5±0.05	
UMK105 CG181JVHF			CG	C0G	180 p	±5%	1000	200	0.5±0.05	
UMK105 CG221JVHF			CG	C0G	220 p	±5%	1000	200	0.5±0.05	
UMK105 CG271JVHF			CG	C0G	270 p	±5%	1000	200	0.5±0.05	
UMK105 CG331JVHF			CG	C0G	330 p	±5%	1000	200	0.5±0.05	
UMK105 CG391JVHF			CG	C0G	390 p	±5%	1000	200	0.5±0.05	
UMK105 CG471JVHF			CG	C0G	470 p	±5%	1000	200	0.5±0.05	
UMK105 CG561JVHF			CG	C0G	560 p	±5%	1000	200	0.5±0.05	
UMK105 CG681JVHF		CG	C0G	680 p	±5%	1000	200	0.5±0.05		
UMK105 CG821JVHF		CG	C0G	820 p	±5%	1000	200	0.5±0.05		
UMK105 CG102JVHF		CG	C0G	1000 p	±5%	1000	200	0.5±0.05		

▶ This catalog contains the typical specification only due to the limitation of space. When you consider the purchase of our products, please check our product specification sheets. For details of each product (characteristics graph, reliability information, precautions for use, and so on), see our website (<http://www.ty-top.com/>).

CERAMIC CAPACITORS
 AUTO
 For Automotive Electronic Equipment
 MULTILAYER CERAMIC CAPACITORS (TEMPERATURE COMPENSATING TYPE)

Medium-High Voltage Multilayer Ceramic Capacitors

● 105TYPE (Dimension:1.0×0.5mm JIS:1005 EIA:0402)

【Temperature Characteristic B7 : X7R(-55~+125°C), C7 : X7S(-55~+125°C)】 0.5mm thickness (V)

Part number 1	Part number 2	Rated voltage [V]	Temperature characteristics	Capacitance [F]	Capacitance tolerance [%]	tan δ [%]	HTLT		Thickness*1 [mm]	Note
							Rated voltage x %			
HMK105 B7221[VHFE]		100	X7R	220 p	±10, ±20	3.5	200		0.5±0.05	
HMK105 B7331[VHFE]			X7R	330 p	±10, ±20	3.5	200		0.5±0.05	
HMK105 B7471[VHFE]			X7R	470 p	±10, ±20	3.5	200		0.5±0.05	
HMK105 B7681[VHFE]			X7R	680 p	±10, ±20	3.5	200		0.5±0.05	
HMK105 B7102[VHFE]			X7R	1000 p	±10, ±20	3.5	200		0.5±0.05	
HMK105 B7152[VHFE]			X7R	1500 p	±10, ±20	3.5	200		0.5±0.05	
HMK105 B7222[VHFE]			X7R	2200 p	±10, ±20	3.5	200		0.5±0.05	
HMK105 B7332[VHFE]			X7R	3300 p	±10, ±20	3.5	200		0.5±0.05	
HMK105 B7472[VHFE]			X7R	4700 p	±10, ±20	3.5	200		0.5±0.05	
HMK105 B7682[VHFE]			X7R	6800 p	±10, ±20	3.5	200		0.5±0.05	
HMK105 B7103[VHFE]			X7R	0.01 μ	±10, ±20	3.5	200		0.5±0.05	

● 107TYPE (Dimension:1.6×0.8mm JIS:1608 EIA:0603)

【Temperature Characteristic B7 : X7R(-55~+125°C), C7 : X7S(-55~+125°C)】 0.8mm thickness (A)

Part number 1	Part number 2	Rated voltage [V]	Temperature characteristics	Capacitance [F]	Capacitance tolerance [%]	tan δ [%]	HTLT		Thickness*1 [mm]	Note
							Rated voltage x %			
HMK107 B7102[AHT]		100	X7R	1000 p	±10, ±20	3.5	200		0.8±0.10	
HMK107 B7152[AHT]			X7R	1500 p	±10, ±20	3.5	200		0.8±0.10	
HMK107 B7222[AHT]			X7R	2200 p	±10, ±20	3.5	200		0.8±0.10	
HMK107 B7332[AHT]			X7R	3300 p	±10, ±20	3.5	200		0.8±0.10	
HMK107 B7472[AHT]			X7R	4700 p	±10, ±20	3.5	200		0.8±0.10	
HMK107 B7682[AHT]			X7R	6800 p	±10, ±20	3.5	200		0.8±0.10	
HMK107 B7103[AHT]			X7R	0.01 μ	±10, ±20	3.5	200		0.8±0.10	
HMK107 B7153[AHT]			X7R	0.015 μ	±10, ±20	3.5	200		0.8±0.10	
HMK107 B7223[AHT]			X7R	0.022 μ	±10, ±20	3.5	200		0.8±0.10	
HMK107 B7333[AHT]			X7R	0.033 μ	±10, ±20	3.5	200		0.8±0.10	
HMK107 B7473[AHT]			X7R	0.047 μ	±10, ±20	3.5	200		0.8±0.10	
HMK107AB7683[AHTE]			X7R	0.068 μ	±10, ±20	3.5	200		0.8±0.15/-0.05	
HMK107 B7104[AHT]			X7R	0.1 μ	±10, ±20	3.5	200		0.8±0.10	
HMK107AC7154[AHTE]			X7S	0.15 μ	±10, ±20	3.5	150		0.8±0.15/-0.05	
HMK107 C7224[AHTE]			X7S	0.22 μ	±10, ±20	3.5	150		0.8±0.10	

● 212TYPE (Dimension:2.0×1.25mm JIS:2012 EIA:0805)

【Temperature Characteristic B7 : X7R(-55~+125°C), C7 : X7S(-55~+125°C)】 1.25mm thickness (G)

Part number 1	Part number 2	Rated voltage [V]	Temperature characteristics	Capacitance [F]	Capacitance tolerance [%]	tan δ [%]	HTLT		Thickness*1 [mm]	Note	
							Rated voltage x %				
HMK212 B7472[GHT]		100	X7R	4700 p	±10, ±20	2.5	200		1.25±0.10		
HMK212 B7682[GHT]			X7R	6800 p	±10, ±20	2.5	200		1.25±0.10		
HMK212 B7103[GHT]			X7R	0.01 μ	±10, ±20	3.5	200		1.25±0.10		
HMK212 B7153[GHT]			X7R	0.015 μ	±10, ±20	3.5	200		1.25±0.10		
HMK212 B7223[GHT]			X7R	0.022 μ	±10, ±20	3.5	200		1.25±0.10		
HMK212 B7333[GHT]			X7R	0.033 μ	±10, ±20	3.5	200		1.25±0.10		
HMK212 B7473[GHT]			X7R	0.047 μ	±10, ±20	3.5	200		1.25±0.10		
HMK212 B7683[GHT]			X7R	0.068 μ	±10, ±20	3.5	200		1.25±0.10		
HMK212 B7104[GHT]			X7R	0.1 μ	±10, ±20	3.5	200		1.25±0.10		
HMK212BB7154[GHTE]			X7R	0.15 μ	±10, ±20	3.5	200		1.25±0.20/-0		
HMK212 B7224[GHT]			X7R	0.22 μ	±10, ±20	3.5	200		1.25±0.10		
HMK212BC7334[GHTE]			X7S	0.33 μ	±10, ±20	3.5	150		1.25±0.20/-0		
HMK212 C7474[GHTE]			X7S	0.47 μ	±10, ±20	3.5	150		1.25±0.10		
HMK212CC7684[GHTE]			X7S	0.68 μ	±10, ±20	3.5	150		1.25±0.25/-0		
HMK212BC7105[GHTE]			X7S	1 μ	±10, ±20	3.5	150		1.25±0.20/-0		
QMK212 B7472[GHT]			250	X7R	4700 p	±10, ±20	2.5	150		1.25±0.10	
QMK212 B7682[GHT]				X7R	6800 p	±10, ±20	2.5	150		1.25±0.10	
QMK212 B7103[GHT]				X7R	0.01 μ	±10, ±20	2.5	150		1.25±0.10	
QMK212 B7153[GHT]				X7R	0.015 μ	±10, ±20	2.5	150		1.25±0.10	
QMK212 B7223[GHT]		X7R		0.022 μ	±10, ±20	2.5	150		1.25±0.10		

【Temperature Characteristic B7 : X7R(-55~+125°C)】 0.85mm thickness (D)

Part number 1	Part number 2	Rated voltage [V]	Temperature characteristics	Capacitance [F]	Capacitance tolerance [%]	tan δ [%]	HTLT		Thickness*1 [mm]	Note	
							Rated voltage x %				
HMK212 B7102[DHT]		100	X7R	1000 p	±10, ±20	2.5	200		0.85±0.10		
HMK212 B7152[DHT]			X7R	1500 p	±10, ±20	2.5	200		0.85±0.10		
HMK212 B7222[DHT]			X7R	2200 p	±10, ±20	2.5	200		0.85±0.10		
HMK212 B7332[DHT]			X7R	3300 p	±10, ±20	2.5	200		0.85±0.10		
QMK212 B7102[DHT]			250	X7R	1000 p	±10, ±20	2.5	150		0.85±0.10	
QMK212 B7152[DHT]				X7R	1500 p	±10, ±20	2.5	150		0.85±0.10	
QMK212 B7222[DHT]		X7R		2200 p	±10, ±20	2.5	150		0.85±0.10		
QMK212 B7332[DHT]		X7R		3300 p	±10, ±20	2.5	150		0.85±0.10		

► This catalog contains the typical specification only due to the limitation of space. When you consider the purchase of our products, please check our product specification sheets. For details of each product (characteristics graph, reliability information, precautions for use, and so on), see our website (<http://www.ty-top.com/>).

■ PART NUMBER

● 316TYPE (Dimension:3.2 × 1.6mm JIS:3216 EIA:1206)

【Temperature Characteristic B7 : X7R(−55~+125°C), C7 : X7S(−55~+125°C)】 1.6mm thickness(L)

Part number 1	Part number 2	Rated voltage [V]	Temperature characteristics	Capacitance [F]	Capacitance tolerance [%]	tan δ [%]	HTLT		Thickness*1 [mm]	Note
							Rated voltage x %			
HMK316 B7473□LHT		100	X7R	0.047 μ	±10, ±20	3.5	200	1.6±0.20		
HMK316 B7683□LHT			X7R	0.068 μ	±10, ±20	3.5	200	1.6±0.20		
HMK316 B7104□LHT			X7R	0.1 μ	±10, ±20	3.5	200	1.6±0.20		
HMK316 B7154□LHT			X7R	0.15 μ	±10, ±20	3.5	200	1.6±0.20		
HMK316 B7224□LHT			X7R	0.22 μ	±10, ±20	3.5	200	1.6±0.20		
HMK316 B7334□LHT			X7R	0.33 μ	±10, ±20	3.5	200	1.6±0.20		
HMK316 B7474□LHT			X7R	0.47 μ	±10, ±20	3.5	200	1.6±0.20		
HMK316 B7105□LHT			X7R	1 μ	±10, ±20	3.5	200	1.6±0.20		
HMK316BC7155□LHTE			X7S	1.5 μ	±10, ±20	3.5	150	1.6±0.30		
HMK316AC7225□LHTE			X7S	2.2 μ	±10, ±20	3.5	150	1.6±0.20		
QMK316 B7223□LHT		250	X7R	0.022 μ	±10, ±20	2.5	150	1.6±0.20		
QMK316 B7333□LHT			X7R	0.033 μ	±10, ±20	2.5	150	1.6±0.20		
QMK316 B7473□LHT			X7R	0.047 μ	±10, ±20	2.5	150	1.6±0.20		
QMK316 B7683□LHT			X7R	0.068 μ	±10, ±20	2.5	150	1.6±0.20		
QMK316 B7104□LHT		630	X7R	0.1 μ	±10, ±20	2.5	150	1.6±0.20		
SMK316 B7153□LHT			X7R	0.015 μ	±10, ±20	2.5	120	1.6±0.20		
SMK316 B7223□LHT			X7R	0.022 μ	±10, ±20	2.5	120	1.6±0.20		
SMK316AB7333□LHT			X7R	0.033 μ	±10, ±20	2.5	120	1.6±0.20		
SMK316AB7473□LHT			X7R	0.047 μ	±10, ±20	2.5	120	1.6±0.20		

【Temperature Characteristic B7 : X7R(−55~+125°C)】 1.15mm thickness(F)

Part number 1	Part number 2	Rated voltage [V]	Temperature characteristics	Capacitance [F]	Capacitance tolerance [%]	tan δ [%]	HTLT		Thickness*1 [mm]	Note
							Rated voltage x %			
SMK316 B7102□FHT		630	X7R	1000 p	±10, ±20	2.5	120	1.15±0.10		
SMK316 B7152□FHT			X7R	1500 p	±10, ±20	2.5	120	1.15±0.10		
SMK316 B7222□FHT			X7R	2200 p	±10, ±20	2.5	120	1.15±0.10		
SMK316 B7332□FHT			X7R	3300 p	±10, ±20	2.5	120	1.15±0.10		
SMK316 B7472□FHT			X7R	4700 p	±10, ±20	2.5	120	1.15±0.10		
SMK316 B7682□FHT			X7R	6800 p	±10, ±20	2.5	120	1.15±0.10		
SMK316 B7103□FHT			X7R	0.01 μ	±10, ±20	2.5	120	1.15±0.10		

● 325TYPE (Dimension:3.2 × 2.5mm JIS:3225 EIA:1210)

【Temperature Characteristic B7 : X7R(−55~+125°C), C7 : X7S(−55~+125°C)】 2.5mm thickness(M)

Part number 1	Part number 2	Rated voltage [V]	Temperature characteristics	Capacitance [F]	Capacitance tolerance [%]	tan δ [%]	HTLT		Thickness*1 [mm]	Note
							Rated voltage x %			
HMK325 B7225□MHP		100	X7R	2.2 μ	±10, ±20	3.5	200	2.5±0.20		
HMK325 C7475□MHPE			X7S	4.7 μ	±10, ±20	3.5	150	2.5±0.20		

【Temperature Characteristic B7 : X7R(−55~+125°C)】 1.9mm thickness(N)

Part number 1	Part number 2	Rated voltage [V]	Temperature characteristics	Capacitance [F]	Capacitance tolerance [%]	tan δ [%]	HTLT		Thickness*1 [mm]	Note
							Rated voltage x %			
HMK325 B7224□NHT		100	X7R	0.22 μ	±10, ±20	3.5	200	1.9±0.20		
HMK325 B7474□NHT			X7R	0.47 μ	±10, ±20	3.5	200	1.9±0.20		
HMK325 B7684□NHT			X7R	0.68 μ	±10, ±20	3.5	200	1.9±0.20		
HMK325 B7105□NHT			X7R	1 μ	±10, ±20	3.5	200	1.9±0.20		
QMK325 B7473□NHT		250	X7R	0.047 μ	±10, ±20	2.5	150	1.9±0.20		
QMK325 B7104□NHT			X7R	0.1 μ	±10, ±20	2.5	150	1.9±0.20		
QMK325 B7154□NHT			X7R	0.15 μ	±10, ±20	2.5	150	1.9±0.20		
QMK325 B7224□NHT			X7R	0.22 μ	±10, ±20	2.5	150	1.9±0.20		
SMK325 B7223□NHT		630	X7R	0.022 μ	±10, ±20	2.5	120	1.9±0.20		
SMK325 B7333□NHT			X7R	0.033 μ	±10, ±20	2.5	120	1.9±0.20		
SMK325 B7473□NHT			X7R	0.047 μ	±10, ±20	2.5	120	1.9±0.20		

● 432TYPE (Dimension:4.5 × 3.2mm JIS:4532 EIA:1812)

【Temperature Characteristic B7 : X7R(−55~+125°C)】 2.5mm thickness(M)

Part number 1	Part number 2	Rated voltage [V]	Temperature characteristics	Capacitance [F]	Capacitance tolerance [%]	tan δ [%]	HTLT		Thickness*1 [mm]	Note
							Rated voltage x %			
HMK432 B7474□MHT		100	X7R	0.47 μ	±10, ±20	3.5	200	2.5±0.20		
HMK432 B7105□MHT			X7R	1 μ	±10, ±20	3.5	200	2.5±0.20		
HMK432 B7155□MHT			X7R	1.5 μ	±10, ±20	3.5	200	2.5±0.20		
HMK432 B7225□MHT			X7R	2.2 μ	±10, ±20	3.5	200	2.5±0.20		
QMK432 B7104□MHT		250	X7R	0.1 μ	±10, ±20	2.5	150	2.5±0.20		
QMK432 B7224□MHT			X7R	0.22 μ	±10, ±20	2.5	150	2.5±0.20		
QMK432 B7334□MHT			X7R	0.33 μ	±10, ±20	2.5	150	2.5±0.20		
QMK432 B7474□MHT			X7R	0.47 μ	±10, ±20	2.5	150	2.5±0.20		
SMK432 B7473□MHT		630	X7R	0.047 μ	±10, ±20	2.5	120	2.5±0.20		
SMK432 B7683□MHT			X7R	0.068 μ	±10, ±20	2.5	120	2.5±0.20		
SMK432 B7104□MHT			X7R	0.1 μ	±10, ±20	2.5	120	2.5±0.20		

▶ This catalog contains the typical specification only due to the limitation of space. When you consider the purchase of our products, please check our product specification sheets. For details of each product (characteristics graph, reliability information, precautions for use, and so on), see our website (<http://www.ty-top.com/>).

CERAMIC CAPACITORS
 AUTO
 For Automotive Electronic Equipment
 MEDIUM-HIGH VOLTAGE MULTILAYER CERAMIC CAPACITORS

Medium-High Voltage Multilayer Ceramic Capacitors for High Frequency Applications

● 105TYPE (Dimension:1.0×0.5mm JIS:1608 EIA:0603)

【Temperature Characteristic CG : CG/C0G (−55~+125°C)】 0.5mm thickness (V)

Part number 1	Part number 2	Rated voltage [V]	Temperature characteristics		Capacitance [F]	Capacitance tolerance	Q [at 1MHz] (Min)	HTLT	Thickness*1 [mm]	Note
								Rated voltage x %		
QVS105 CG0R5[VHF]		250	CG	C0G	0.5 p	±0.1pF, ±0.25pF	810	200	0.5±0.05	
QVS105 CG0R6[VHF]			CG	C0G	0.6 p	±0.1pF, ±0.25pF	812	200	0.5±0.05	
QVS105 CG0R7[VHF]			CG	C0G	0.7 p	±0.1pF, ±0.25pF	814	200	0.5±0.05	
QVS105 CGR75[VHF]			CG	C0G	0.75 p	±0.1pF, ±0.25pF	815	200	0.5±0.05	
QVS105 CG0R8[VHF]			CG	C0G	0.8 p	±0.1pF, ±0.25pF	816	200	0.5±0.05	
QVS105 CG0R9[VHF]			CG	C0G	0.9 p	±0.1pF, ±0.25pF	818	200	0.5±0.05	
QVS105 CG010[VHF]			CG	C0G	1 p	±0.1pF, ±0.25pF	820	200	0.5±0.05	
QVS105 CG1R1[VHF]			CG	C0G	1.1 p	±0.1pF, ±0.25pF	822	200	0.5±0.05	
QVS105 CG1R2[VHF]			CG	C0G	1.2 p	±0.1pF, ±0.25pF	824	200	0.5±0.05	
QVS105 CG1R3[VHF]			CG	C0G	1.3 p	±0.1pF, ±0.25pF	826	200	0.5±0.05	
QVS105 CG1R5[VHF]			CG	C0G	1.5 p	±0.1pF, ±0.25pF	830	200	0.5±0.05	
QVS105 CG1R6[VHF]			CG	C0G	1.6 p	±0.1pF, ±0.25pF	832	200	0.5±0.05	
QVS105 CG1R8[VHF]			CG	C0G	1.8 p	±0.1pF, ±0.25pF	836	200	0.5±0.05	
QVS105 CG020[VHF]			CG	C0G	2 p	±0.1pF, ±0.25pF	840	200	0.5±0.05	
QVS105 CG2R2[VHF]			CG	C0G	2.2 p	±0.1pF, ±0.25pF	844	200	0.5±0.05	
QVS105 CG2R4[VHF]			CG	C0G	2.4 p	±0.1pF, ±0.25pF	848	200	0.5±0.05	
QVS105 CG2R7[VHF]			CG	C0G	2.7 p	±0.1pF, ±0.25pF	854	200	0.5±0.05	
QVS105 CG030[VHF]			CG	C0G	3 p	±0.1pF, ±0.25pF	860	200	0.5±0.05	
QVS105 CG3R3[VHF]			CG	C0G	3.3 p	±0.1pF, ±0.25pF	866	200	0.5±0.05	
QVS105 CG3R6[VHF]			CG	C0G	3.6 p	±0.1pF, ±0.25pF	872	200	0.5±0.05	
QVS105 CG3R9[VHF]			CG	C0G	3.9 p	±0.1pF, ±0.25pF	878	200	0.5±0.05	
QVS105 CG4R3[VHF]			CG	C0G	4.3 p	±0.1pF, ±0.25pF	886	200	0.5±0.05	
QVS105 CG4R7[VHF]			CG	C0G	4.7 p	±0.1pF, ±0.25pF	894	200	0.5±0.05	
QVS105 CG5R1[VHF]			CG	C0G	5.1 p	±0.25pF, ±0.5pF	902	200	0.5±0.05	
QVS105 CG5R6[VHF]			CG	C0G	5.6 p	±0.25pF, ±0.5pF	912	200	0.5±0.05	
QVS105 CG6R2[VHF]			CG	C0G	6.2 p	±0.25pF, ±0.5pF	924	200	0.5±0.05	
QVS105 CG6R8[VHF]			CG	C0G	6.8 p	±0.25pF, ±0.5pF	936	200	0.5±0.05	
QVS105 CG7R5[VHF]			CG	C0G	7.5 p	±0.25pF, ±0.5pF	950	200	0.5±0.05	
QVS105 CG8R2[VHF]			CG	C0G	8.2 p	±0.25pF, ±0.5pF	964	200	0.5±0.05	
QVS105 CG9R1[VHF]			CG	C0G	9.1 p	±0.25pF, ±0.5pF	982	200	0.5±0.05	
QVS105 CG100JVHF			CG	C0G	10 p	±5%	1000	200	0.5±0.05	
QVS105 CG110JVHF			CG	C0G	11 p	±5%	1020	200	0.5±0.05	
QVS105 CG120JVHF			CG	C0G	12 p	±5%	1040	200	0.5±0.05	
QVS105 CG130JVHF			CG	C0G	13 p	±5%	1060	200	0.5±0.05	
QVS105 CG150JVHF			CG	C0G	15 p	±5%	1100	200	0.5±0.05	
QVS105 CG160JVHF			CG	C0G	16 p	±5%	1120	200	0.5±0.05	
QVS105 CG180JVHF			CG	C0G	18 p	±5%	1160	200	0.5±0.05	
QVS105 CG200JVHF			CG	C0G	20 p	±5%	1200	200	0.5±0.05	
QVS105 CG220JVHF			CG	C0G	22 p	±5%	1240	200	0.5±0.05	
QVS105 CG240JVHF			CG	C0G	24 p	±5%	1280	200	0.5±0.05	
QVS105 CG270JVHF		CG	C0G	27 p	±5%	1340	200	0.5±0.05		
QVS105 CG300JVHF		CG	C0G	30 p	±5%	1400	200	0.5±0.05		
QVS105 CG330JVHF		CG	C0G	33 p	±5%	1400	200	0.5±0.05		

► This catalog contains the typical specification only due to the limitation of space. When you consider the purchase of our products, please check our product specification sheets. For details of each product (characteristics graph, reliability information, precautions for use, and so on), see our website (<http://www.ty-top.com/>).

● 107TYPE (Dimension:1.6×0.8mm JIS:1608 EIA:0603)

【Temperature Characteristic CG : CG/C0G(−55~+125°C)】 0.7mm thickness(C)

Part number 1	Part number 2	Rated voltage [V]	Temperature characteristics		Capacitance [F]	Capacitance tolerance	Q [at 1MHz] (Min)	HTLT	Thickness*1 [mm]	Note
								Rated voltage x %		
QVS107 CG0R2□CHT		250	CG	C0G	0.2 p	±0.05pF, ±0.1pF	804	200	0.7±0.10	
QVS107 CG0R3□CHT			CG	C0G	0.3 p	±0.05pF, ±0.1pF	806	200	0.7±0.10	
QVS107 CG0R4□CHT			CG	C0G	0.4 p	±0.05pF, ±0.1pF	808	200	0.7±0.10	
QVS107 CG0R5□CHT			CG	C0G	0.5 p	±0.1pF, ±0.25pF	810	200	0.7±0.10	
QVS107 CG0R6□CHT			CG	C0G	0.6 p	±0.1pF, ±0.25pF	812	200	0.7±0.10	
QVS107 CG0R7□CHT			CG	C0G	0.7 p	±0.1pF, ±0.25pF	814	200	0.7±0.10	
QVS107 CGR75□CHT			CG	C0G	0.75 p	±0.1pF, ±0.25pF	815	200	0.7±0.10	
QVS107 CG0R8□CHT			CG	C0G	0.8 p	±0.1pF, ±0.25pF	816	200	0.7±0.10	
QVS107 CG0R9□CHT			CG	C0G	0.9 p	±0.1pF, ±0.25pF	818	200	0.7±0.10	
QVS107 CG010□CHT			CG	C0G	1 p	±0.1pF, ±0.25pF	820	200	0.7±0.10	
QVS107 CG1R1□CHT			CG	C0G	1.1 p	±0.1pF, ±0.25pF	822	200	0.7±0.10	
QVS107 CG1R2□CHT			CG	C0G	1.2 p	±0.1pF, ±0.25pF	824	200	0.7±0.10	
QVS107 CG1R3□CHT			CG	C0G	1.3 p	±0.1pF, ±0.25pF	826	200	0.7±0.10	
QVS107 CG1R5□CHT			CG	C0G	1.5 p	±0.1pF, ±0.25pF	830	200	0.7±0.10	
QVS107 CG1R6□CHT			CG	C0G	1.6 p	±0.1pF, ±0.25pF	832	200	0.7±0.10	
QVS107 CG1R8□CHT			CG	C0G	1.8 p	±0.1pF, ±0.25pF	836	200	0.7±0.10	
QVS107 CG020□CHT			CG	C0G	2 p	±0.1pF, ±0.25pF	840	200	0.7±0.10	
QVS107 CG2R2□CHT			CG	C0G	2.2 p	±0.1pF, ±0.25pF	844	200	0.7±0.10	
QVS107 CG2R4□CHT			CG	C0G	2.4 p	±0.1pF, ±0.25pF	848	200	0.7±0.10	
QVS107 CG2R7□CHT			CG	C0G	2.7 p	±0.1pF, ±0.25pF	854	200	0.7±0.10	
QVS107 CG030□CHT			CG	C0G	3 p	±0.1pF, ±0.25pF	860	200	0.7±0.10	
QVS107 CG3R3□CHT			CG	C0G	3.3 p	±0.1pF, ±0.25pF	866	200	0.7±0.10	
QVS107 CG3R6□CHT			CG	C0G	3.6 p	±0.1pF, ±0.25pF	872	200	0.7±0.10	
QVS107 CG3R9□CHT			CG	C0G	3.9 p	±0.1pF, ±0.25pF	878	200	0.7±0.10	
QVS107 CG4R3□CHT			CG	C0G	4.3 p	±0.1pF, ±0.25pF	886	200	0.7±0.10	
QVS107 CG4R7□CHT			CG	C0G	4.7 p	±0.1pF, ±0.25pF	894	200	0.7±0.10	
QVS107 CG5R1□CHT			CG	C0G	5.1 p	±0.25pF, ±0.5pF	902	200	0.7±0.10	
QVS107 CG5R6□CHT			CG	C0G	5.6 p	±0.25pF, ±0.5pF	912	200	0.7±0.10	
QVS107 CG6R2□CHT			CG	C0G	6.2 p	±0.25pF, ±0.5pF	924	200	0.7±0.10	
QVS107 CG6R8□CHT			CG	C0G	6.8 p	±0.25pF, ±0.5pF	936	200	0.7±0.10	
QVS107 CG7R5□CHT			CG	C0G	7.5 p	±0.25pF, ±0.5pF	950	200	0.7±0.10	
QVS107 CG8R2□CHT			CG	C0G	8.2 p	±0.25pF, ±0.5pF	964	200	0.7±0.10	
QVS107 CG9R1□CHT			CG	C0G	9.1 p	±0.25pF, ±0.5pF	982	200	0.7±0.10	
QVS107 CG100□CHT			CG	C0G	10 p	±2%, ±5%	1000	200	0.7±0.10	
QVS107 CG110JCHT			CG	C0G	11 p	±5%	1020	200	0.7±0.10	
QVS107 CG120JCHT			CG	C0G	12 p	±5%	1040	200	0.7±0.10	
QVS107 CG130JCHT			CG	C0G	13 p	±5%	1060	200	0.7±0.10	
QVS107 CG150JCHT			CG	C0G	15 p	±5%	1100	200	0.7±0.10	
QVS107 CG160JCHT			CG	C0G	16 p	±5%	1120	200	0.7±0.10	
QVS107 CG180JCHT			CG	C0G	18 p	±5%	1160	200	0.7±0.10	
QVS107 CG200JCHT			CG	C0G	20 p	±5%	1200	200	0.7±0.10	
QVS107 CG220JCHT			CG	C0G	22 p	±5%	1240	200	0.7±0.10	
QVS107 CG240JCHT			CG	C0G	24 p	±5%	1280	200	0.7±0.10	
QVS107 CG270JCHT			CG	C0G	27 p	±5%	1340	200	0.7±0.10	
QVS107 CG300JCHT			CG	C0G	30 p	±5%	1400	200	0.7±0.10	
QVS107 CG330JCHT			CG	C0G	33 p	±5%	1400	200	0.7±0.10	
QVS107 CG360JCHT			CG	C0G	36 p	±5%	1400	200	0.7±0.10	
QVS107 CG390JCHT			CG	C0G	39 p	±5%	1400	200	0.7±0.10	
QVS107 CG430JCHT			CG	C0G	43 p	±5%	1400	200	0.7±0.10	
QVS107 CG470JCHT			CG	C0G	47 p	±5%	1400	200	0.7±0.10	
QVS107 CG510JCHT			CG	C0G	51 p	±5%	1400	200	0.7±0.10	
QVS107 CG560JCHT			CG	C0G	56 p	±5%	1400	200	0.7±0.10	
QVS107 CG620JCHT			CG	C0G	62 p	±5%	1400	200	0.7±0.10	
QVS107 CG680JCHT			CG	C0G	68 p	±5%	1400	200	0.7±0.10	
QVS107 CG750JCHT			CG	C0G	75 p	±5%	1400	200	0.7±0.10	
QVS107 CG820JCHT			CG	C0G	82 p	±5%	1400	200	0.7±0.10	
QVS107 CG910JCHT			CG	C0G	91 p	±5%	1400	200	0.7±0.10	
QVS107 CG101JCHT			CG	C0G	100 p	±5%	1400	200	0.7±0.10	

CERAMIC CAPACITORS

AUTO

For Automotive Electronic Equipment MEDIUM-HIGH VOLTAGE MULTILAYER CERAMIC CAPACITORS FOR HIGH FREQUENCY APPLICATIONS

▶ This catalog contains the typical specification only due to the limitation of space. When you consider the purchase of our products, please check our product specification sheets. For details of each product (characteristics graph, reliability information, precautions for use, and so on), see our website (<http://www.ty-top.com/>).

■ PART NUMBER

● 212TYPE (Dimension:2.0×1.25mm JIS:2012 EIA:0805)
 【Temperature Characteristic CG : CG/COG (−55~+125°C)】 0.85mm thickness (D)

Part number 1	Part number 2	Rated voltage [V]	Temperature characteristics	Capacitance [F]	Capacitance tolerance	Q [at 1MHz] (Min)	HTLT	Thickness*1 [mm]	Note	
							Rated voltage x %			
QVS212 CG0R3[DHT]		250	CG	COG	0.3 p	±0.1pF, ±0.25pF	806	200	0.85±0.10	
QVS212 CG0R4[DHT]			CG	COG	0.4 p	±0.1pF, ±0.25pF	808	200	0.85±0.10	
QVS212 CG0R5[DHT]			CG	COG	0.5 p	±0.1pF, ±0.25pF	810	200	0.85±0.10	
QVS212 CG0R6[DHT]			CG	COG	0.6 p	±0.1pF, ±0.25pF	812	200	0.85±0.10	
QVS212 CG0R7[DHT]			CG	COG	0.7 p	±0.1pF, ±0.25pF	814	200	0.85±0.10	
QVS212 CGR75[DHT]			CG	COG	0.75 p	±0.1pF, ±0.25pF	815	200	0.85±0.10	
QVS212 CG0R8[DHT]			CG	COG	0.8 p	±0.1pF, ±0.25pF	816	200	0.85±0.10	
QVS212 CG0R9[DHT]			CG	COG	0.9 p	±0.1pF, ±0.25pF	818	200	0.85±0.10	
QVS212 CG010[DHT]			CG	COG	1 p	±0.1pF, ±0.25pF	820	200	0.85±0.10	
QVS212 CG1R1[DHT]			CG	COG	1.1 p	±0.1pF, ±0.25pF	822	200	0.85±0.10	
QVS212 CG1R2[DHT]			CG	COG	1.2 p	±0.1pF, ±0.25pF	824	200	0.85±0.10	
QVS212 CG1R3[DHT]			CG	COG	1.3 p	±0.1pF, ±0.25pF	826	200	0.85±0.10	
QVS212 CG1R5[DHT]			CG	COG	1.5 p	±0.1pF, ±0.25pF	830	200	0.85±0.10	
QVS212 CG1R6[DHT]			CG	COG	1.6 p	±0.1pF, ±0.25pF	832	200	0.85±0.10	
QVS212 CG1R8[DHT]			CG	COG	1.8 p	±0.1pF, ±0.25pF	836	200	0.85±0.10	
QVS212 CG020[DHT]			CG	COG	2 p	±0.1pF, ±0.25pF	840	200	0.85±0.10	
QVS212 CG2R2[DHT]			CG	COG	2.2 p	±0.1pF, ±0.25pF	844	200	0.85±0.10	
QVS212 CG2R4[DHT]			CG	COG	2.4 p	±0.1pF, ±0.25pF	848	200	0.85±0.10	
QVS212 CG2R7[DHT]			CG	COG	2.7 p	±0.1pF, ±0.25pF	854	200	0.85±0.10	
QVS212 CG030[DHT]			CG	COG	3 p	±0.1pF, ±0.25pF	860	200	0.85±0.10	
QVS212 CG3R3[DHT]			CG	COG	3.3 p	±0.1pF, ±0.25pF	866	200	0.85±0.10	
QVS212 CG3R6[DHT]			CG	COG	3.6 p	±0.1pF, ±0.25pF	872	200	0.85±0.10	
QVS212 CG3R9[DHT]			CG	COG	3.9 p	±0.1pF, ±0.25pF	878	200	0.85±0.10	
QVS212 CG4R3[DHT]			CG	COG	4.3 p	±0.1pF, ±0.25pF	886	200	0.85±0.10	
QVS212 CG4R7[DHT]			CG	COG	4.7 p	±0.1pF, ±0.25pF	894	200	0.85±0.10	
QVS212 CG5R1[DHT]			CG	COG	5.1 p	±0.25pF, ±0.5pF	902	200	0.85±0.10	
QVS212 CG5R6[DHT]			CG	COG	5.6 p	±0.25pF, ±0.5pF	912	200	0.85±0.10	
QVS212 CG6R2[DHT]			CG	COG	6.2 p	±0.25pF, ±0.5pF	924	200	0.85±0.10	
QVS212 CG6R8[DHT]			CG	COG	6.8 p	±0.25pF, ±0.5pF	936	200	0.85±0.10	
QVS212 CG7R5[DHT]			CG	COG	7.5 p	±0.25pF, ±0.5pF	950	200	0.85±0.10	
QVS212 CG8R2[DHT]			CG	COG	8.2 p	±0.25pF, ±0.5pF	964	200	0.85±0.10	
QVS212 CG9R1[DHT]			CG	COG	9.1 p	±0.25pF, ±0.5pF	982	200	0.85±0.10	
QVS212 CG100JDHT			CG	COG	10 p	±5%	1000	200	0.85±0.10	
QVS212 CG110JDHT			CG	COG	11 p	±5%	1020	200	0.85±0.10	
QVS212 CG120JDHT			CG	COG	12 p	±5%	1040	200	0.85±0.10	
QVS212 CG130JDHT			CG	COG	13 p	±5%	1060	200	0.85±0.10	
QVS212 CG150JDHT			CG	COG	15 p	±5%	1100	200	0.85±0.10	
QVS212 CG160JDHT			CG	COG	16 p	±5%	1120	200	0.85±0.10	
QVS212 CG180JDHT			CG	COG	18 p	±5%	1160	200	0.85±0.10	
QVS212 CG200JDHT			CG	COG	20 p	±5%	1200	200	0.85±0.10	
QVS212 CG220JDHT			CG	COG	22 p	±5%	1240	200	0.85±0.10	
QVS212 CG240JDHT			CG	COG	24 p	±5%	1280	200	0.85±0.10	
QVS212 CG270JDHT			CG	COG	27 p	±5%	1340	200	0.85±0.10	
QVS212 CG300JDHT			CG	COG	30 p	±5%	1400	200	0.85±0.10	
QVS212 CG330JDHT			CG	COG	33 p	±5%	1400	200	0.85±0.10	
QVS212 CG360JDHT			CG	COG	36 p	±5%	1400	200	0.85±0.10	
QVS212 CG390JDHT			CG	COG	39 p	±5%	1400	200	0.85±0.10	
QVS212 CG430JDHT			CG	COG	43 p	±5%	1400	200	0.85±0.10	
QVS212 CG470JDHT			CG	COG	47 p	±5%	1400	200	0.85±0.10	
QVS212 CG510JDHT			CG	COG	51 p	±5%	1400	200	0.85±0.10	
QVS212 CG560JDHT			CG	COG	56 p	±5%	1400	200	0.85±0.10	
QVS212 CG620JDHT			CG	COG	62 p	±5%	1400	200	0.85±0.10	
QVS212 CG680JDHT			CG	COG	68 p	±5%	1400	200	0.85±0.10	
QVS212 CG750JDHT			CG	COG	75 p	±5%	1400	200	0.85±0.10	
QVS212 CG820JDHT			CG	COG	82 p	±5%	1400	200	0.85±0.10	
QVS212 CG910JDHT			CG	COG	91 p	±5%	1400	200	0.85±0.10	
QVS212 CG101JDHT			CG	COG	100 p	±5%	1400	200	0.85±0.10	

CERAMIC CAPACITORS
 AUTO

For Automotive Electronic Equipment
 MEDIUM-HIGH VOLTAGE MULTILAYER CERAMIC CAPACITORS FOR HIGH FREQUENCY APPLICATIONS

▶ This catalog contains the typical specification only due to the limitation of space. When you consider the purchase of our products, please check our product specification sheets. For details of each product (characteristics graph, reliability information, precautions for use, and so on), see our website (<http://www.ty-top.com/>).

Soft Termination Multilayer Ceramic Capacitors

● 107TYPE (Dimension:1.6×0.8mm JIS:1608 EIA:0603)

【Temperature Characteristic B7 : X7R(-55~+125°C)】 0.8mm thickness(A)

Part number 1	Part number 2	Rated voltage [V]	Temperature characteristics	Capacitance [F]	Capacitance tolerance [%]	tan δ [%]	HTLT		Thickness*1 [mm]	Note
							Rated voltage x %			
TMJ107BB7473□AHT		25	X7R	0.047 μ	±10, ±20	3.5	200		0.8+0.20/-0	
TMJ107BB7104□AHT			X7R	0.1 μ	±10, ±20	3.5	200		0.8+0.20/-0	
TMJ107BB7224□AHT			X7R	0.22 μ	±10, ±20	10	150		0.8+0.20/-0	
TMJ107BB7474□AHT			X7R	0.47 μ	±10, ±20	10	150		0.8+0.20/-0	
TMJ107CB7105□AHR		35	X7R	1 μ	±10, ±20	10	150		0.8+0.25/-0	
GMJ107BB7473□AHT			X7R	0.047 μ	±10, ±20	3.5	200		0.8+0.20/-0	
GMJ107BB7104□AHT			X7R	0.1 μ	±10, ±20	3.5	200		0.8+0.20/-0	
GMJ107BB7224□AHT			X7R	0.22 μ	±10, ±20	10	150		0.8+0.20/-0	
GMJ107BB7474□AHT		50	X7R	0.47 μ	±10, ±20	10	150		0.8+0.20/-0	
GMJ107CB7105□AHR			X7R	1 μ	±10, ±20	10	150		0.8+0.25/-0	
UMJ107AB7102□AHT			X7R	1000 p	±10, ±20	3.5	200		0.8+0.15/-0.05	
UMJ107AB7222□AHT			X7R	2200 p	±10, ±20	3.5	200		0.8+0.15/-0.05	
UMJ107BB7472□AHT		100	X7R	4700 p	±10, ±20	3.5	200		0.8+0.20/-0	
UMJ107BB7103□AHT			X7R	0.01 μ	±10, ±20	3.5	200		0.8+0.20/-0	
UMJ107BB7223□AHT			X7R	0.022 μ	±10, ±20	3.5	200		0.8+0.20/-0	
UMJ107BB7473□AHT			X7R	0.047 μ	±10, ±20	3.5	200		0.8+0.20/-0	
UMJ107BB7104□AHT		100	X7R	0.1 μ	±10, ±20	3.5	200		0.8+0.20/-0	
HMJ107AB7102□AHT			X7R	1000 p	±10, ±20	3.5	200		0.8+0.15/-0.05	
HMJ107AB7222□AHT			X7R	2200 p	±10, ±20	3.5	200		0.8+0.15/-0.05	
HMJ107BB7472□AHT			X7R	4700 p	±10, ±20	3.5	200		0.8+0.20/-0	
HMJ107BB7103□AHT		100	X7R	0.01 μ	±10, ±20	3.5	200		0.8+0.20/-0	
HMJ107BB7223□AHT			X7R	0.022 μ	±10, ±20	3.5	200		0.8+0.20/-0	
HMJ107BB7473□AHT			X7R	0.047 μ	±10, ±20	3.5	200		0.8+0.20/-0	
HMJ107BB7104□AHT			X7R	0.1 μ	±10, ±20	3.5	200		0.8+0.20/-0	

● 212TYPE (Dimension:2.0×1.25mm JIS:2012 EIA:0805)

【Temperature Characteristic B7 : X7R(-55~+125°C), C7 : X7S(-55~+125°C)】 0.85mm thickness(D), 1.25mm thickness(G)

Part number 1	Part number 2	Rated voltage [V]	Temperature characteristics	Capacitance [F]	Capacitance tolerance [%]	tan δ [%]	HTLT		Thickness*1 [mm]	Note	
							Rated voltage x %				
JMJ212CB7106□GHT		6.3	X7R	10 μ	±10, ±20	10	150		1.25+0.25/-0		
EMJ212CB7225□GHT		16	X7R	2.2 μ	±10, ±20	10	150		1.25+0.25/-0		
EMJ212CB7475□GHT			X7R	4.7 μ	±10, ±20	10	150		1.25+0.25/-0		
TMJ212CB7225□GHT		25	X7R	2.2 μ	±10, ±20	10	150		1.25+0.25/-0		
GMJ212CB7105□GHT		35	X7R	1 μ	±10, ±20	10	150		1.25+0.25/-0		
UMJ212BB7103□GHT			X7R	0.01 μ	±10, ±20	3.5	200		1.25+0.20/-0		
UMJ212BB7223□GHT		50	X7R	0.022 μ	±10, ±20	3.5	200		1.25+0.20/-0		
UMJ212BB7473□GHT			X7R	0.047 μ	±10, ±20	3.5	200		1.25+0.20/-0		
UMJ212BB7104□GHT			X7R	0.1 μ	±10, ±20	3.5	200		1.25+0.20/-0		
UMJ212BB7224□GHT			X7R	0.22 μ	±10, ±20	3.5	200		1.25+0.20/-0		
UMJ212CC7474□GHTE		50	X7S	0.47 μ	±10, ±20	3.5	150		1.25+0.25/-0		
UMJ212CB7105□GHT			X7R	1 μ	±10, ±20	10	150		1.25+0.25/-0		
HMJ212KB7102□DHT			100	X7R	1000 p	±10, ±20	3.5	200		0.85±0.15	
HMJ212KB7222□DHT				X7R	2200 p	±10, ±20	3.5	200		0.85±0.15	
HMJ212BB7472□GHT		X7R		4700 p	±10, ±20	3.5	200		1.25+0.20/-0		
HMJ212BB7103□GHT		X7R		0.01 μ	±10, ±20	3.5	200		1.25+0.20/-0		
HMJ212BB7223□GHT		100	X7R	0.022 μ	±10, ±20	3.5	200		1.25+0.20/-0		
HMJ212BB7473□GHT			X7R	0.047 μ	±10, ±20	3.5	200		1.25+0.20/-0		
HMJ212BB7104□GHT			X7R	0.1 μ	±10, ±20	3.5	200		1.25+0.20/-0		
HMJ212BB7224□GHT			X7R	0.22 μ	±10, ±20	3.5	200		1.25+0.20/-0		
HMJ212CC7474□GHTE		100	X7S	0.47 μ	±10, ±20	3.5	150		1.25+0.25/-0		
HMJ212DC7105□GHTE			X7S	1 μ	±10, ±20	3.5	150		1.25+0.30/-0		
QMJ212KB7102□DHT			250	X7R	1000 p	±10, ±20	2.5	150		0.85±0.15	
QMJ212KB7222□DHT				X7R	2200 p	±10, ±20	2.5	150		0.85±0.15	
QMJ212BB7472□GHT		X7R		4700 p	±10, ±20	2.5	150		1.25+0.20/-0		
QMJ212BB7103□GHT		X7R		0.01 μ	±10, ±20	2.5	150		1.25+0.20/-0		
QMJ212BB7223□GHT		250	X7R	0.022 μ	±10, ±20	2.5	150		1.25+0.20/-0		
QMJ212BB7104□GHT			X7R	0.1 μ	±10, ±20	2.5	150		1.25+0.20/-0		

▶ This catalog contains the typical specification only due to the limitation of space. When you consider the purchase of our products, please check our product specification sheets. For details of each product (characteristics graph, reliability information, precautions for use, and so on), see our website (<http://www.ty-top.com/>).

CERAMIC CAPACITORS
 AUTO
 For Automotive Electronic Equipment
 SOFT TERMINATION MULTILAYER CERAMIC CAPACITORS

■ PART NUMBER

● 316TYPE (Dimension:3.2×1.6mm JIS:3216 EIA:1206)

【Temperature Characteristic B7 : X7R(-55~+125°C), C7 : X7S(-55~+125°C)】 1.15mm thickness (F)、1.6mm thickness (L)

Part number 1	Part number 2	Rated voltage [V]	Temperature characteristics	Capacitance [F]	Capacitance tolerance [%]	tan δ [%]	HTLT		Thickness*1 [mm]	Note	
							Rated voltage x %				
LMJ316BB7226□LHT		10	X7R	22 μ	±10, ±20	10	150		1.6±0.30		
EMJ316BB7475□LHT		16	X7R	4.7 μ	±10, ±20	10	150		1.6±0.30		
EMJ316BB7106□LHT			X7R	10 μ	±10, ±20	10	150		1.6±0.30		
TMJ316BB7474□LHT		25	X7R	0.47 μ	±10, ±20	3.5	200		1.6±0.30		
TMJ316BB7475□LHT			X7R	4.7 μ	±10, ±20	10	150		1.6±0.30		
TMJ316BB7106□LHT			X7R	10 μ	±10, ±20	10	150		1.6±0.30		
GMJ316BB7474□LHT			X7R	0.47 μ	±10, ±20	3.5	200		1.6±0.30		
GMJ316AB7225□LHT		35	X7R	2.2 μ	±10, ±20	10	150		1.6±0.20		
GMJ316BB7475□LHT			X7R	4.7 μ	±10, ±20	10	150		1.6±0.30		
GMJ316BB7106□LHT			X7R	10 μ	±10, ±20	10	150		1.6±0.30		
UMJ316BB7473□LHT			X7R	0.047 μ	±10, ±20	3.5	200		1.6±0.30		
UMJ316BB7104□LHT		50	X7R	0.1 μ	±10, ±20	3.5	200		1.6±0.30		
UMJ316BB7224□LHT			X7R	0.22 μ	±10, ±20	3.5	200		1.6±0.30		
UMJ316BB7474□LHT			X7R	0.47 μ	±10, ±20	3.5	200		1.6±0.30		
UMJ316BB7105□LHT			X7R	1 μ	±10, ±20	3.5	200		1.6±0.30		
UMJ316AB7225□LHT			X7R	2.2 μ	±10, ±20	10	150		1.6±0.20		
UMJ316BC7475□LHTE			X7S	4.7 μ	±10, ±20	2.5	150		1.6±0.30		
HMJ316 B7102□FHT			100	X7R	1000 p	±10, ±20	3.5	200		1.15±0.10	
HMJ316 B7222□FHT				X7R	2200 p	±10, ±20	3.5	200		1.15±0.10	
HMJ316 B7472□FHT				X7R	4700 p	±10, ±20	3.5	200		1.15±0.10	
HMJ316KB7103□FHT				X7R	0.01 μ	±10, ±20	3.5	200		1.15±0.20	
HMJ316BB7223□LHT		X7R		0.022 μ	±10, ±20	3.5	200		1.6±0.30		
HMJ316BB7473□LHT		X7R		0.047 μ	±10, ±20	3.5	200		1.6±0.30		
HMJ316BB7104□LHT		X7R		0.1 μ	±10, ±20	3.5	200		1.6±0.30		
HMJ316BB7224□LHT		X7R		0.22 μ	±10, ±20	3.5	200		1.6±0.30		
HMJ316BB7474□LHT		X7R		0.47 μ	±10, ±20	3.5	200		1.6±0.30		
HMJ316BB7105□LHT		X7R		1 μ	±10, ±20	3.5	200		1.6±0.30		
HMJ316BC7225□LHTE		X7S		2.2 μ	±10, ±20	3.5	150		1.6±0.30		
QMJ316 B7102□FHT		250		X7R	1000 p	±10, ±20	2.5	150		1.15±0.10	
QMJ316 B7222□FHT				X7R	2200 p	±10, ±20	2.5	150		1.15±0.10	
QMJ316 B7472□FHT				X7R	4700 p	±10, ±20	2.5	150		1.15±0.10	
QMJ316KB7103□FHT				X7R	0.01 μ	±10, ±20	2.5	150		1.15±0.20	
QMJ316BB7223□LHT				X7R	0.022 μ	±10, ±20	2.5	150		1.6±0.30	
QMJ316BB7473□LHT				X7R	0.047 μ	±10, ±20	2.5	150		1.6±0.30	
QMJ316BB7104□LHT				X7R	0.1 μ	±10, ±20	2.5	150		1.6±0.30	
SMJ316 B7102□FHT			630	X7R	1000 p	±10, ±20	2.5	120		1.15±0.10	
SMJ316 B7222□FHT				X7R	2200 p	±10, ±20	2.5	120		1.15±0.10	
SMJ316 B7472□FHT				X7R	4700 p	±10, ±20	2.5	120		1.15±0.10	
SMJ316KB7103□FHT		X7R		0.01 μ	±10, ±20	2.5	120		1.15±0.20		
SMJ316BB7223□LHT		X7R		0.022 μ	±10, ±20	2.5	120		1.6±0.30		
		X7R		0.022 μ	±10, ±20	2.5	120		1.6±0.30		

● 325TYPE (Dimension:3.2×2.5mm JIS:3225 EIA:1210)

【Temperature Characteristic B7 : X7R(-55~+125°C), C7 : X7S(-55~+125°C)】 1.9mm thickness (N)、2.5mm thickness (M)

Part number 1	Part number 2	Rated voltage [V]	Temperature characteristics	Capacitance [F]	Capacitance tolerance [%]	tan δ [%]	HTLT		Thickness*1 [mm]	Note
							Rated voltage x %			
JMJ325KB7476□MHP		6.3	X7R	47 μ	±10, ±20	10	150		2.5±0.30	
EMJ325KB7226□MHP		16	X7R	22 μ	±10, ±20	10	150		2.5±0.30	
TMJ325AB7475□MHP			X7R	4.7 μ	±10, ±20	5	150		2.5±0.30	
TMJ325KB7106□MHP		25	X7R	10 μ	±10, ±20	10	150		2.5±0.30	
GMJ325AB7475□MHP			X7R	4.7 μ	±10, ±20	5	150		2.5±0.30	
GMJ325KB7106□MHP		35	X7R	10 μ	±10, ±20	10	150		2.5±0.30	
UMJ325AB7225□MHP			X7R	2.2 μ	±10, ±20	3.5	200		2.5±0.30	
UMJ325AB7475□MHP		50	X7R	4.7 μ	±10, ±20	5	150		2.5±0.30	
UMJ325KB7106□MHP			X7R	10 μ	±10, ±20	10	150		2.5±0.30	
HMJ325 B7223□NHT			X7R	0.022 μ	±10, ±20	3.5	200		1.9±0.20	
HMJ325 B7473□NHT			X7R	0.047 μ	±10, ±20	3.5	200		1.9±0.20	
HMJ325 B7104□NHT		100	X7R	0.1 μ	±10, ±20	3.5	200		1.9±0.20	
HMJ325 B7224□NHT			X7R	0.22 μ	±10, ±20	3.5	200		1.9±0.20	
HMJ325 B7474□NHT			X7R	0.47 μ	±10, ±20	3.5	200		1.9±0.20	
HMJ325 B7105□NHT			X7R	1 μ	±10, ±20	3.5	200		1.9±0.20	
HMJ325AB7225□MHP			X7R	2.2 μ	±10, ±20	3.5	200		2.5±0.30	
HMJ325KC7475□MHPE			X7S	4.7 μ	±10, ±20	3.5	150		2.5±0.30	
QMJ325 B7223□NHT		250	X7R	0.022 μ	±10, ±20	2.5	150		1.9±0.20	
QMJ325 B7473□NHT			X7R	0.047 μ	±10, ±20	2.5	150		1.9±0.20	
QMJ325 B7104□NHT			X7R	0.1 μ	±10, ±20	2.5	150		1.9±0.20	
QMJ325 B7224□NHT			X7R	0.22 μ	±10, ±20	2.5	150		1.9±0.20	
SMJ325 B7223□NHT		630	X7R	0.022 μ	±10, ±20	2.5	120		1.9±0.20	
SMJ325 B7473□NHT			X7R	0.047 μ	±10, ±20	2.5	120		1.9±0.20	

▶ This catalog contains the typical specification only due to the limitation of space. When you consider the purchase of our products, please check our product specification sheets. For details of each product (characteristics graph, reliability information, precautions for use, and so on), see our website (<http://www.ty-top.com/>).

LW Reversal Decoupling Capacitors (LWDC™)

● 105TYPE (Dimension:0.52×1.0mm JIS:0510 EIA:0204)

【Temperature Characteristic BJ : X5R(−55~+85°C)】 0.3mm thickness (P)

Part number 1	Part number 2	Rated voltage [V]	Temperature characteristics	Capacitance [F]	Capacitance tolerance [%]	tan δ [%]	HTLT		Thickness*1 [mm]	Note
							Rated voltage x %			
TWK105 BJ104MPHF		25	X5R	0.1 μ	±20	5	150		0.3±0.05	
EWK105 BJ224MPHF		16	X5R	0.22 μ	±20	10	150		0.3±0.05	
LWK105 BJ474MPHF		10	X5R	0.47 μ	±20	10	150		0.3±0.05	
AWK105 BJ105MPHF		4	X5R	1 μ	±20	10	150		0.3±0.05	

【Temperature Characteristic C6 : X6S(−55~+105°C), C7 : X7S(−55~+125°C)】 0.3mm thickness (P)

Part number 1	Part number 2	Rated voltage [V]	Temperature characteristics	Capacitance [F]	Capacitance tolerance [%]	tan δ [%]	HTLT		Thickness*1 [mm]	Note
							Rated voltage x %			
EWK105 C6104MPHF		16	X6S	0.1 μ	±20	5	150		0.3±0.05	
LWK105 C7104MPHF		10	X7S	0.1 μ	±20	5	150		0.3±0.05	
LWK105 C6224MPHF		6.3	X6S	0.22 μ	±20	10	150		0.3±0.05	
JWK105 C7104MPHF			X7S	0.1 μ	±20	5	150		0.3±0.05	
JWK105 C7224MPHF		4	X7S	0.22 μ	±20	10	150		0.3±0.05	
JWK105 C6474MPHF			X6S	0.47 μ	±20	10	150		0.3±0.05	
AWK105 C7224MPHF		4	X7S	0.22 μ	±20	10	150		0.3±0.05	
AWK105 C6474MPHF			X6S	0.47 μ	±20	10	150		0.3±0.05	

● 107TYPE (Dimension:0.8×1.6mm JIS:0816 EIA:0306)

【Temperature Characteristic BJ : X5R(−55~+85°C)】 0.5mm thickness (V)

Part number 1	Part number 2	Rated voltage [V]	Temperature characteristics	Capacitance [F]	Capacitance tolerance [%]	tan δ [%]	HTLT		Thickness*1 [mm]	Note
							Rated voltage x %			
LWK107 BJ105MVHT		10	X5R	1 μ	±20	10	150		0.5±0.05	
JWK107 BJ225MVHT		6.3	X5R	2.2 μ	±20	10	150		0.5±0.05	
JWK107 BJ475MVHT			X5R	4.7 μ	±20	10	150		0.5±0.05	

【Temperature Characteristic B7 : X7R(−55~+125°C), C6 : X6S(−55~+105°C), C7 : X7S(−55~+125°C)】 0.5mm thickness (V)

Part number 1	Part number 2	Rated voltage [V]	Temperature characteristics	Capacitance [F]	Capacitance tolerance [%]	tan δ [%]	HTLT		Thickness*1 [mm]	Note
							Rated voltage x %			
TWK107 B7104MVHT		25	X7R	0.1 μ	±20	5	150		0.5±0.05	
EWK107 B7224MVHT		16	X7R	0.22 μ	±20	5	150		0.5±0.05	
EWK107 B7474MVHT			X7R	0.47 μ	±20	5	150		0.5±0.05	
LWK107 B7474MVHT		10	X7R	0.47 μ	±20	5	150		0.5±0.05	
JWK107 C7105MVHT		6.3	X7S	1 μ	±20	10	150		0.5±0.05	
AWK107 C6225MVHT			X6S	2.2 μ	±20	10	150		0.5±0.05	
AWK107 C6475MVHT		4	X6S	4.7 μ	±20	10	150		0.5±0.05	

● 212TYPE (Dimension:1.25×2.0mm JIS:1220 EIA:0508)

【Temperature Characteristic BJ : X5R(−55~+85°C)】 0.85mm thickness (D)

Part number 1	Part number 2	Rated voltage [V]	Temperature characteristics	Capacitance [F]	Capacitance tolerance [%]	tan δ [%]	HTLT		Thickness*1 [mm]	Note
							Rated voltage x %			
LWK212 BJ475□DHT		10	X5R	4.7 μ	±10, ±20	10	150		0.85±0.10	
JWK212 BJ106MDHT		6.3	X5R	10 μ	±20	10	150		0.85±0.10	
AWK212 BJ226MDHT			X5R	22 μ	±20	10	150		0.85±0.10	

【Temperature Characteristic C6 : X6S(−55~+105°C)】 0.85mm thickness (D)

Part number 1	Part number 2	Rated voltage [V]	Temperature characteristics	Capacitance [F]	Capacitance tolerance [%]	tan δ [%]	HTLT		Thickness*1 [mm]	Note
							Rated voltage x %			
JWK212 C6475□DHT		6.3	X6S	4.7 μ	±10, ±20	10	150		0.85±0.10	

▶ This catalog contains the typical specification only due to the limitation of space. When you consider the purchase of our products, please check our product specification sheets. For details of each product (characteristics graph, reliability information, precautions for use, and so on), see our website (<http://www.ty-top.com/>).

- All the Multilayer Ceramic Capacitors of the catalog lineup are RoHS compliant.
- Capacitance tolerance code is applied to □ of part number.
- All the Multilayer Ceramic Capacitors in the catalog lineup are applicable for reflow-soldering.

Notes)

- The exchange of individual specifications is necessary depending on your application and/or circuit condition. Please contact TAIYO YUDEN's official sales channel.
- For Automotive (AEC-Q200 Qualified) products for POWERTRAIN, and SAFETY. Please check "Automotive Application Guide" for further details before using the products.
 - < **AEC-Q200** : AEC-Q200 qualified >
 - All the Multilayer Ceramic Capacitors for Automotive products are tested based on the test conditions and methods defined in AEC-Q200 family item. 125°C products: AEC-Q200 Grade1 (we conduct the evaluation at the test condition of Grade1.)
 - Please consult with TAIYO YUDEN's official sales channel for the details of the product specifications and AEC-Q200 test results, etc., and please review and approve the product specifications before ordering.
- *1: For standard case size, please kindly refer to ④Dimension, ⑤Dimension tolerance, ⑨Thickness and STANDARD EXTERNAL DIMENSIONS.

High Reliability Application Multilayer Ceramic Capacitors

● 105TYPE (Dimension:1.0×0.5mm JIS:1005 EIA:0402)
 【Temperature Characteristic B7 : X7R(-55~+125°C)】 0.5mm thickness (V)

Part number 1	Part number 2	Rated voltage [V]	Temperature characteristics	Capacitance [F]	Capacitance tolerance [%]	tan δ [%]	HTLT		Thickness*1 [mm]	Note
							Rated voltage x %			
UMF105 B7102□VHF		50	X7R	1000 p	±10, ±20	2.5	200		0.5±0.05	
UMF105 B7222□VHF			X7R	2200 p	±10, ±20	2.5	200		0.5±0.05	
UMF105 B7472□VHF			X7R	4700 p	±10, ±20	2.5	150		0.5±0.05	
UMF105 B7103□VHF			X7R	0.01 μ	±10, ±20	3.5	200		0.5±0.05	
TMF105 B7102□VHF			X7R	1000 p	±10, ±20	2.5	200		0.5±0.05	
TMF105 B7222□VHF			X7R	2200 p	±10, ±20	2.5	200		0.5±0.05	
TMF105 B7472□VHF		X7R	4700 p	±10, ±20	2.5	200		0.5±0.05		
TMF105 B7103□VHF		25	X7R	0.01 μ	±10, ±20	3.5	200		0.5±0.05	
TMF105 B7223□VHF			X7R	0.022 μ	±10, ±20	3.5	150		0.5±0.05	
TMF105 B7473□VHF			X7R	0.047 μ	±10, ±20	3.5	150		0.5±0.05	
EMF105 B7103□VHF			X7R	1000 p	±10, ±20	2.5	200		0.5±0.05	
EMF105 B7222□VHF			X7R	2200 p	±10, ±20	2.5	200		0.5±0.05	
EMF105 B7472□VHF			X7R	4700 p	±10, ±20	2.5	200		0.5±0.05	
EMF105 B7103□VHF		16	X7R	0.01 μ	±10, ±20	3.5	200		0.5±0.05	
EMF105 B7223□VHF			X7R	0.022 μ	±10, ±20	3.5	200		0.5±0.05	
EMF105 B7473□VHF			X7R	0.047 μ	±10, ±20	3.5	200		0.5±0.05	
EMF105 B7104□VHF			X7R	0.1 μ	±10, ±20	5	150		0.5±0.05	
LMF105 B7102□VHF			X7R	1000 p	±10, ±20	2.5	200		0.5±0.05	
LMF105 B7222□VHF			X7R	2200 p	±10, ±20	2.5	200		0.5±0.05	
LMF105 B7472□VHF		10	X7R	4700 p	±10, ±20	2.5	200		0.5±0.05	
LMF105 B7103□VHF			X7R	0.01 μ	±10, ±20	3.5	200		0.5±0.05	
LMF105 B7223□VHF			X7R	0.022 μ	±10, ±20	3.5	200		0.5±0.05	
LMF105 B7473□VHF			X7R	0.047 μ	±10, ±20	3.5	200		0.5±0.05	
LMF105 B7104□VHF			X7R	0.1 μ	±10, ±20	5	200		0.5±0.05	

● 107TYPE (Dimension:1.6×0.8mm JIS:1608 EIA:0603)
 【Temperature Characteristic B7 : X7R(-55~+125°C)】 0.8mm thickness (A)

Part number 1	Part number 2	Rated voltage [V]	Temperature characteristics	Capacitance [F]	Capacitance tolerance [%]	tan δ [%]	HTLT		Thickness*1 [mm]	Note	
							Rated voltage x %				
UMF107 B7223□AHT		50	X7R	0.022 μ	±10, ±20	3.5	200		0.8±0.10		
UMF107 B7473□AHT			X7R	0.047 μ	±10, ±20	3.5	200		0.8±0.10		
UMF107 B7104□AHT			X7R	0.1 μ	±10, ±20	3.5	200		0.8±0.10		
TMF107 B7223□AHT			X7R	0.022 μ	±10, ±20	3.5	200		0.8±0.10		
TMF107 B7473□AHT			X7R	0.047 μ	±10, ±20	3.5	200		0.8±0.10		
TMF107 B7104□AHT			25	X7R	0.1 μ	±10, ±20	3.5	200		0.8±0.10	
TMF107 B7224□AHT		X7R		0.22 μ	±10, ±20	10	150		0.8±0.10		
TMF107 B7474□AHT		X7R		0.47 μ	±10, ±20	10	150		0.8±0.10		
EMF107 B7223□AHT		X7R		0.022 μ	±10, ±20	3.5	200		0.8±0.10		
EMF107 B7473□AHT		X7R		0.047 μ	±10, ±20	3.5	200		0.8±0.10		
EMF107 B7104□AHT		16		X7R	0.1 μ	±10, ±20	3.5	200		0.8±0.10	
EMF107 B7224□AHT			X7R	0.22 μ	±10, ±20	5	200		0.8±0.10		
EMF107 B7474□AHT			X7R	0.47 μ	±10, ±20	10	150		0.8±0.10		
EMF107 B7105□AHT			X7R	1 μ	±10, ±20	10	150		0.8±0.10		
LMF107 B7223□AHT			10	X7R	0.022 μ	±10, ±20	3.5	200		0.8±0.10	
LMF107 B7473□AHT				X7R	0.047 μ	±10, ±20	3.5	200		0.8±0.10	
LMF107 B7104□AHT		X7R		0.1 μ	±10, ±20	3.5	200		0.8±0.10		
LMF107 B7224□AHT		X7R		0.22 μ	±10, ±20	5	200		0.8±0.10		
LMF107 B7474□AHT		X7R		0.47 μ	±10, ±20	10	150		0.8±0.10		
LMF107 B7105□AHT		X7R		1 μ	±10, ±20	10	150		0.8±0.10		

► This catalog contains the typical specification only due to the limitation of space. When you consider the purchase of our products, please check our product specification sheets. For details of each product (characteristics graph, reliability information, precautions for use, and so on), see our website (<http://www.ty-top.com/>).

● 212TYPE (Dimension:2.0×1.25mm JIS:2012 EIA:0805)

【Temperature Characteristic B7 : X7R(−55~+125°C)】 1.25mm thickness(G)

Part number 1	Part number 2	Rated voltage [V]	Temperature characteristics	Capacitance [F]	Capacitance tolerance [%]	tan δ [%]	HTLT		Thickness*1 [mm]	Note
							Rated voltage x %			
HMF212 B7103[GHT]		100	X7R	0.01 μ	±10, ±20	3.5	200	1.25±0.10		
HMF212 B7223[GHT]			X7R	0.022 μ	±10, ±20	3.5	200	1.25±0.10		
HMF212 B7473[GHT]			X7R	0.047 μ	±10, ±20	3.5	200	1.25±0.10		
HMF212 B7104[GHT]			X7R	0.1 μ	±10, ±20	3.5	200	1.25±0.10		
HMF212 B7224[GHT]		50	X7R	0.22 μ	±10, ±20	3.5	200	1.25±0.10		
UMF212 B7103[GHT]			X7R	0.01 μ	±10, ±20	3.5	200	1.25±0.10		
UMF212 B7223[GHT]			X7R	0.022 μ	±10, ±20	3.5	200	1.25±0.10		
UMF212 B7473[GHT]			X7R	0.047 μ	±10, ±20	3.5	200	1.25±0.10		
UMF212 B7105[GHT]		25	X7R	0.1 μ	±10, ±20	3.5	200	1.25±0.10		
TMF212 B7103[GHT]			X7R	0.01 μ	±10, ±20	3.5	200	1.25±0.10		
TMF212 B7223[GHT]			X7R	0.022 μ	±10, ±20	3.5	200	1.25±0.10		
TMF212 B7473[GHT]			X7R	0.047 μ	±10, ±20	3.5	200	1.25±0.10		
TMF212 B7104[GHT]		16	X7R	0.1 μ	±10, ±20	3.5	200	1.25±0.10		
TMF212 B7224[GHT]			X7R	0.22 μ	±10, ±20	3.5	200	1.25±0.10		
TMF212 B7474[GHT]			X7R	0.47 μ	±10, ±20	3.5	200	1.25±0.10		
TMF212 B7105[GHT]			X7R	1 μ	±10, ±20	10	200	1.25±0.10		
TMF212 B7225[GHT]		10	X7R	2.2 μ	±10, ±20	10	150	1.25±0.10		
EMF212 B7473[GHT]			X7R	0.047 μ	±10, ±20	3.5	200	1.25±0.10		
EMF212 B7104[GHT]			X7R	0.1 μ	±10, ±20	3.5	200	1.25±0.10		
EMF212 B7224[GHT]			X7R	0.22 μ	±10, ±20	3.5	200	1.25±0.10		
EMF212 B7474[GHT]		6.3	X7R	0.47 μ	±10, ±20	3.5	200	1.25±0.10		
EMF212 B7105[GHT]			X7R	1 μ	±10, ±20	10	200	1.25±0.10		
EMF212 B7225[GHT]			X7R	2.2 μ	±10, ±20	10	200	1.25±0.10		
EMF212AB7475[GHT]			X7R	4.7 μ	±10, ±20	10	150	1.25±0.15/-0.05		
LMF212 B7473[GHT]		10	X7R	0.047 μ	±10, ±20	3.5	200	1.25±0.10		
LMF212 B7104[GHT]			X7R	0.1 μ	±10, ±20	3.5	200	1.25±0.10		
LMF212 B7224[GHT]			X7R	0.22 μ	±10, ±20	3.5	200	1.25±0.10		
LMF212 B7474[GHT]			X7R	0.47 μ	±10, ±20	3.5	200	1.25±0.10		
LMF212 B7105[GHT]		6.3	X7R	1 μ	±10, ±20	10	200	1.25±0.10		
LMF212 B7225[GHT]			X7R	2.2 μ	±10, ±20	10	200	1.25±0.10		
LMF212 B7475[GHT]			X7R	4.7 μ	±10, ±20	10	150	1.25±0.10		
JMF212AB7106[GHT]			X7R	10 μ	±10, ±20	10	150	1.25±0.15/-0.05		

● 316TYPE (Dimension:3.2×1.6mm JIS:3216 EIA:1206)

【Temperature Characteristic B7 : X7R(−55~+125°C)】 1.15mm thickness(F)

Part number 1	Part number 2	Rated voltage [V]	Temperature characteristics	Capacitance [F]	Capacitance tolerance [%]	tan δ [%]	HTLT		Thickness*1 [mm]	Note
							Rated voltage x %			
HMF316 B7102[FHT]		100	X7R	1000 p	±10, ±20	2.5	200	1.15±0.10		
HMF316 B7222[FHT]			X7R	2200 p	±10, ±20	2.5	200	1.15±0.10		
HMF316 B7472[FHT]			X7R	4700 p	±10, ±20	2.5	200	1.15±0.10		
HMF316 B7103[FHT]			X7R	0.01 μ	±10, ±20	2.5	200	1.15±0.10		
UMF316 B7102[FHT]		50	X7R	1000 p	±10, ±20	2.5	200	1.15±0.10		
UMF316 B7222[FHT]			X7R	2200 p	±10, ±20	2.5	200	1.15±0.10		
UMF316 B7472[FHT]			X7R	4700 p	±10, ±20	2.5	200	1.15±0.10		
UMF316 B7103[FHT]			X7R	0.01 μ	±10, ±20	2.5	200	1.15±0.10		

【Temperature Characteristic B7 : X7R(−55~+125°C)】 1.6mm thickness(L)

Part number 1	Part number 2	Rated voltage [V]	Temperature characteristics	Capacitance [F]	Capacitance tolerance [%]	tan δ [%]	HTLT		Thickness*1 [mm]	Note
							Rated voltage x %			
HMF316 B7104[LHT]		100	X7R	0.1 μ	±10, ±20	3.5	200	1.6±0.20		
HMF316 B7224[LHT]			X7R	0.22 μ	±10, ±20	3.5	150	1.6±0.20		
HMF316 B7474[LHT]			X7R	0.47 μ	±10, ±20	3.5	150	1.6±0.20		
UMF316 B7104[LHT]			X7R	0.1 μ	±10, ±20	3.5	200	1.6±0.20		
UMF316 B7224[LHT]		50	X7R	0.22 μ	±10, ±20	3.5	200	1.6±0.20		
UMF316 B7474[LHT]			X7R	0.47 μ	±10, ±20	3.5	200	1.6±0.20		
UMF316 B7105[LHT]			X7R	1 μ	±10, ±20	3.5	150	1.6±0.20		
TMF316 B7104[LHT]			25	X7R	0.1 μ	±10, ±20	3.5	200	1.6±0.20	
TMF316 B7224[LHT]		X7R		0.22 μ	±10, ±20	3.5	200	1.6±0.20		
TMF316 B7474[LHT]		X7R		0.47 μ	±10, ±20	3.5	200	1.6±0.20		
TMF316 B7105[LHT]		X7R		1 μ	±10, ±20	3.5	200	1.6±0.20		
TMF316 B7225[LHT]		16	X7R	2.2 μ	±10, ±20	3.5	200	1.6±0.20		
TMF316AB7475[LHT]			X7R	4.7 μ	±10, ±20	10	150	1.6±0.20		
EMF316 B7224[LHT]			X7R	0.22 μ	±10, ±20	3.5	200	1.6±0.20		
EMF316 B7474[LHT]			X7R	0.47 μ	±10, ±20	3.5	200	1.6±0.20		
EMF316 B7105[LHT]		10	X7R	1 μ	±10, ±20	3.5	200	1.6±0.20		
EMF316 B7225[LHT]			X7R	2.2 μ	±10, ±20	3.5	200	1.6±0.20		
EMF316AB7475[LHT]			X7R	4.7 μ	±10, ±20	10	200	1.6±0.20		
EMF316AB7106[LHT]			X7R	10 μ	±10, ±20	10	150	1.6±0.20		
LMF316 B7224[LHT]		10	X7R	0.22 μ	±10, ±20	3.5	200	1.6±0.20		
LMF316 B7474[LHT]			X7R	0.47 μ	±10, ±20	3.5	200	1.6±0.20		
LMF316 B7105[LHT]			X7R	1 μ	±10, ±20	3.5	200	1.6±0.20		
LMF316 B7225[LHT]			X7R	2.2 μ	±10, ±20	3.5	200	1.6±0.20		
LMF316AB7475[LHT]		6.3	X7R	4.7 μ	±10, ±20	10	200	1.6±0.20		
LMF316AB7106[LHT]			X7R	10 μ	±10, ±20	10	150	1.6±0.20		
JMF316AB7106[LHT]			X7R	10 μ	±10, ±20	10	200	1.6±0.20		

▶ This catalog contains the typical specification only due to the limitation of space. When you consider the purchase of our products, please check our product specification sheets. For details of each product (characteristics graph, reliability information, precautions for use, and so on), see our website (<http://www.ty-top.com/>).

CERAMIC CAPACITORS
 AUTO
 For Automotive Electronic Equipment
 HIGH RELIABILITY APPLICATION MULTILAYER CERAMIC CAPACITORS

■ PART NUMBER

● 325TYPE (Dimension:3.2×2.5mm JIS:3225 EIA:1210)

【Temperature Characteristic B7 : X7R(−55~+125°C)】 2.5mm thickness (M)

Part number 1	Part number 2	Rated voltage [V]	Temperature characteristics	Capacitance [F]	Capacitance tolerance [%]	tan δ [%]	HTLT		Thickness*1 [mm]	Note
							Rated voltage x %			
HMF325 B7225□MHP		100	X7R	2.2 μ	±10, ±20	3.5	150		2.5±0.20	
UMF325 B7225□MHP		50	X7R	2.2 μ	±10, ±20	3.5	200		2.5±0.20	
UMF325 B7475□MHP			X7R	4.7 μ	±10, ±20	5	150		2.5±0.20	
TMF325 B7225□MHP		25	X7R	2.2 μ	±10, ±20	3.5	200		2.5±0.20	
TMF325 B7475□MHP			X7R	4.7 μ	±10, ±20	5	200		2.5±0.20	
TMF325 B7106□MHP			X7R	10 μ	±10, ±20	10	150		2.5±0.20	
EMF325 B7225□MHP		16	X7R	2.2 μ	±10, ±20	3.5	200		2.5±0.20	
EMF325 B7475□MHP			X7R	4.7 μ	±10, ±20	5	200		2.5±0.20	
EMF325 B7106□MHP			X7R	10 μ	±10, ±20	10	200		2.5±0.20	
LMF325 B7225□MHP		10	X7R	2.2 μ	±10, ±20	3.5	200		2.5±0.20	
LMF325 B7475□MHP			X7R	4.7 μ	±10, ±20	5	200		2.5±0.20	
LMF325 B7106□MHP			X7R	10 μ	±10, ±20	10	200		2.5±0.20	

【Temperature Characteristic B7 : X7R(−55~+125°C)】 1.9mm thickness (N)

Part number 1	Part number 2	Rated voltage [V]	Temperature characteristics	Capacitance [F]	Capacitance tolerance [%]	tan δ [%]	HTLT		Thickness*1 [mm]	Note
							Rated voltage x %			
HMF325 B7223□NHT		100	X7R	0.022 μ	±10, ±20	2.5	200		1.9±0.20	
HMF325 B7473□NHT			X7R	0.047 μ	±10, ±20	2.5	200		1.9±0.20	
HMF325 B7104□NHT			X7R	0.1 μ	±10, ±20	3.5	200		1.9±0.20	
HMF325 B7224□NHT			X7R	0.22 μ	±10, ±20	3.5	200		1.9±0.20	
UMF325 B7223□NHT		50	X7R	0.022 μ	±10, ±20	2.5	200		1.9±0.20	
UMF325 B7473□NHT			X7R	0.047 μ	±10, ±20	2.5	200		1.9±0.20	
UMF325 B7104□NHT			X7R	0.1 μ	±10, ±20	3.5	200		1.9±0.20	
UMF325 B7224□NHT			X7R	0.22 μ	±10, ±20	3.5	200		1.9±0.20	
UMF325 B7474□NHT			X7R	0.47 μ	±10, ±20	3.5	200		1.9±0.20	
UMF325 B7105□NHT		25	X7R	1 μ	±10, ±20	3.5	200		1.9±0.20	
TMF325 B7224□NHT			X7R	0.22 μ	±10, ±20	3.5	200		1.9±0.20	
TMF325 B7474□NHT			X7R	0.47 μ	±10, ±20	3.5	200		1.9±0.20	
TMF325 B7105□NHT			X7R	1 μ	±10, ±20	3.5	200		1.9±0.20	
EMF325 B7224□NHT		16	X7R	0.22 μ	±10, ±20	3.5	200		1.9±0.20	
EMF325 B7474□NHT			X7R	0.47 μ	±10, ±20	3.5	200		1.9±0.20	
EMF325 B7105□NHT			X7R	1 μ	±10, ±20	3.5	200		1.9±0.20	
LMF325 B7224□NHT		10	X7R	0.22 μ	±10, ±20	3.5	200		1.9±0.20	
LMF325 B7474□NHT			X7R	0.47 μ	±10, ±20	3.5	200		1.9±0.20	
LMF325 B7105□NHT			X7R	1 μ	±10, ±20	3.5	200		1.9±0.20	

▶ This catalog contains the typical specification only due to the limitation of space. When you consider the purchase of our products, please check our product specification sheets. For details of each product (characteristics graph, reliability information, precautions for use, and so on), see our website (<http://www.ty-top.com/>).

High Reliability Application Multilayer Ceramic Capacitors (Cu external electrode products)

● 063TYPE (Dimension:0.6×0.3mm JIS:1005 EIA:0402)

【Temperature Characteristic B7 : X7R(−55~+125°C)】 0.3mm thickness(P)

Part number 1	Part number 2	Rated voltage [V]	Temperature characteristics	Capacitance [F]	Capacitance tolerance [%]	tan δ [%]	HTLT		Thickness*1 [mm]	Note	
							Rated voltage x %				
TMR063 B7101□P-F		25	X7R	100 p	±10, ±20	3.5	200		0.3±0.03		
TMR063 B7151□P-F			X7R	150 p	±10, ±20	3.5	200		0.3±0.03		
TMR063 B7221□P-F			X7R	220 p	±10, ±20	3.5	200		0.3±0.03		
TMR063 B7331□P-F			X7R	330 p	±10, ±20	3.5	200		0.3±0.03		
TMR063 B7471□P-F			X7R	470 p	±10, ±20	3.5	200		0.3±0.03		
TMR063 B7102□P-F			X7R	1000 p	±10, ±20	3.5	200		0.3±0.03		
TMR063 B7152□P-F			X7R	1500 p	±10, ±20	5	200		0.3±0.03		
TMR063 B7222□P-F			X7R	2200 p	±10, ±20	5	200		0.3±0.03		
TMR063 B7332□P-F			X7R	3300 p	±10, ±20	5	200		0.3±0.03		
EMR063 B7101□P-F			16	X7R	100 p	±10, ±20	3.5	200		0.3±0.03	
EMR063 B7151□P-F				X7R	150 p	±10, ±20	3.5	200		0.3±0.03	
EMR063 B7221□P-F				X7R	220 p	±10, ±20	3.5	200		0.3±0.03	
EMR063 B7331□P-F				X7R	330 p	±10, ±20	3.5	200		0.3±0.03	
EMR063 B7471□P-F				X7R	470 p	±10, ±20	3.5	200		0.3±0.03	
EMR063 B7102□P-F				X7R	1000 p	±10, ±20	3.5	200		0.3±0.03	
EMR063 B7152□P-F				X7R	1500 p	±10, ±20	5	200		0.3±0.03	
EMR063 B7222□P-F		X7R		2200 p	±10, ±20	5	200		0.3±0.03		
EMR063 B7332□P-F		X7R		3300 p	±10, ±20	5	200		0.3±0.03		
LMR063 B7101□P-F		10		X7R	100 p	±10, ±20	3.5	200		0.3±0.03	
LMR063 B7151□P-F				X7R	150 p	±10, ±20	3.5	200		0.3±0.03	
LMR063 B7221□P-F				X7R	220 p	±10, ±20	3.5	200		0.3±0.03	
LMR063 B7331□P-F				X7R	330 p	±10, ±20	3.5	200		0.3±0.03	
LMR063 B7471□P-F				X7R	470 p	±10, ±20	3.5	200		0.3±0.03	
LMR063 B7102□P-F				X7R	1000 p	±10, ±20	3.5	200		0.3±0.03	
LMR063 B7152□P-F				X7R	1500 p	±10, ±20	5	200		0.3±0.03	
LMR063 B7222□P-F			X7R	2200 p	±10, ±20	5	200		0.3±0.03		
LMR063 B7332□P-F			X7R	3300 p	±10, ±20	5	200		0.3±0.03		
LMR063 B7472□P-F			X7R	4700 p	±10, ±20	5	200		0.3±0.03		
LMR063 B7682□P-F			X7R	6800 p	±10, ±20	5	200		0.3±0.03		
LMR063 B7103□P-F			X7R	0.01 μ	±10, ±20	5	200		0.3±0.03		

● 105TYPE (Dimension:1.0×0.5mm JIS:1608 EIA:0603)

【Temperature Characteristic B7 : X7R(−55~+125°C)】 0.5mm thickness(V)

Part number 1	Part number 2	Rated voltage [V]	Temperature characteristics	Capacitance [F]	Capacitance tolerance [%]	tan δ [%]	HTLT		Thickness*1 [mm]	Note	
							Rated voltage x %				
HMR105 B7221□V-F		100	X7R	220 p	±10, ±20	3.5	200		0.5±0.05		
HMR105 B7331□V-F			X7R	330 p	±10, ±20	3.5	200		0.5±0.05		
HMR105 B7471□V-F			X7R	470 p	±10, ±20	3.5	200		0.5±0.05		
HMR105 B7681□V-F			X7R	680 p	±10, ±20	3.5	200		0.5±0.05		
HMR105 B7102□V-F			X7R	1000 p	±10, ±20	3.5	200		0.5±0.05		
HMR105 B7152□V-F			X7R	1500 p	±10, ±20	3.5	200		0.5±0.05		
HMR105 B7222□V-F			X7R	2200 p	±10, ±20	3.5	200		0.5±0.05		
HMR105 B7332□V-F			X7R	3300 p	±10, ±20	3.5	200		0.5±0.05		
HMR105 B7472□V-F			X7R	4700 p	±10, ±20	3.5	200		0.5±0.05		
HMR105 B7682□V-F			X7R	6800 p	±10, ±20	3.5	200		0.5±0.05		
HMR105 B7103□V-F			X7R	0.01 μ	±10, ±20	3.5	200		0.5±0.05		
UMR105 B7221□V-F			50	X7R	220 p	±10, ±20	3.5	200		0.5±0.05	
UMR105 B7331□V-F				X7R	330 p	±10, ±20	3.5	200		0.5±0.05	
UMR105 B7471□V-F				X7R	470 p	±10, ±20	3.5	200		0.5±0.05	
UMR105 B7681□V-F				X7R	680 p	±10, ±20	3.5	200		0.5±0.05	
UMR105 B7153□V-F				X7R	0.015 μ	±10, ±20	3.5	200		0.5±0.05	
UMR105 B7223□V-F		X7R		0.022 μ	±10, ±20	3.5	200		0.5±0.05		
UMR105 B7333□V-F		X7R		0.033 μ	±10, ±20	3.5	150		0.5±0.05		
UMR105 B7473□V-F		X7R		0.047 μ	±10, ±20	3.5	150		0.5±0.05		
JMR105CD7105□V-F		6.3		X7R	1 μ	±10, ±20	10	150		0.5+0.2/-0	

● 107TYPE (Dimension:1.6×0.8mm JIS:2012 EIA:0805)

【Temperature Characteristic B7 : X7R(−55~+125°C)】 0.8mm thickness(A)

Part number 1	Part number 2	Rated voltage [V]	Temperature characteristics	Capacitance [F]	Capacitance tolerance [%]	tan δ [%]	HTLT		Thickness*1 [mm]	Note	
							Rated voltage x %				
HMR107 B7102□A-T		100	X7R	1000 p	±10, ±20	3.5	200		0.8±0.10		
HMR107 B7152□A-T			X7R	1500 p	±10, ±20	3.5	200		0.8±0.10		
HMR107 B7222□A-T			X7R	2200 p	±10, ±20	3.5	200		0.8±0.10		
HMR107 B7332□A-T			X7R	3300 p	±10, ±20	3.5	200		0.8±0.10		
HMR107 B7472□A-T			X7R	4700 p	±10, ±20	3.5	200		0.8±0.10		
HMR107 B7682□A-T			X7R	6800 p	±10, ±20	3.5	200		0.8±0.10		
HMR107 B7103□A-T			X7R	0.01 μ	±10, ±20	3.5	200		0.8±0.10		
HMR107 B7153□A-T			X7R	0.015 μ	±10, ±20	3.5	200		0.8±0.10		
HMR107 B7223□A-T			X7R	0.022 μ	±10, ±20	3.5	200		0.8±0.10		
HMR107 B7333□A-T			X7R	0.033 μ	±10, ±20	3.5	200		0.8±0.10		
HMR107 B7473□A-T			X7R	0.047 μ	±10, ±20	3.5	200		0.8±0.10		
HMR107AB7104□A-T			X7R	0.1 μ	±10, ±20	3.5	200		0.8±0.10		
UMR107AC7224□A-T			50	X7R	0.22 μ	±10, ±20	3.5	200		0.8+0.15/-0.05	

▶ This catalog contains the typical specification only due to the limitation of space. When you consider the purchase of our products, please check our product specification sheets. For details of each product (characteristics graph, reliability information, precautions for use, and so on), see our website (<http://www.ty-top.com/>).

CERAMIC CAPACITORS
 AUTO
 For Automotive Electronic Equipment
 HIGH RELIABILITY APPLICATION MULTILAYER CERAMIC CAPACITORS (CU EXTERNAL ELECTRODE PRODUCTS)

■ PART NUMBER

● 212TYPE (Dimension:3.2×1.6mm JIS:3216 EIA:1206)

【Temperature Characteristic B7 : X7R(−55~+125°C)】 1.15mm thickness(F)

Part number 1	Part number 2	Rated voltage [V]	Temperature characteristics	Capacitance [F]	Capacitance tolerance [%]	tan δ [%]	HTLT		Thickness*1 [mm]	Note
							Rated voltage x %			
HMR212AC7474□G-T		100	X7S	0.47 μ	±10, ±20	3.5	150		1.25±0.15/-0.05	
HMR212CC7105□G-T			X7S	1 μ	±10, ±20	3.5	150		1.25±0.25/-0	

● 325TYPE (Dimension:3.2×2.5mm JIS:3225 EIA:1210)

【Temperature Characteristic B7 : X7R(−55~+125°C)】 1.6mm thickness(L)

Part number 1	Part number 2	Rated voltage [V]	Temperature characteristics	Capacitance [F]	Capacitance tolerance [%]	tan δ [%]	HTLT		Thickness*1 [mm]	Note
							Rated voltage x %			
HMR316BC7225□L-T		100	X7S	2.2 μ	±10, ±20	3.5	150		1.6±0.30	
UMR316BC7225□L-T		50	X7S	2.2 μ	±10, ±20	3.5	150		1.6±0.30	
UMR316BC7475□L-T			X7S	4.7 μ	±10, ±20	3.5	150		1.6±0.30	

● 325TYPE (Dimension:3.2×2.5mm JIS:3225 EIA:1210)

【Temperature Characteristic B7 : X7R(−55~+125°C)】 2.5mm thickness(M)

Part number 1	Part number 2	Rated voltage [V]	Temperature characteristics	Capacitance [F]	Capacitance tolerance [%]	tan δ [%]	HTLT		Thickness*1 [mm]	Note
							Rated voltage x %			
HMR325AC7475□M-P		100	X7S	4.7 μ	±10, ±20	3.5	150		2.5±0.30	
UMR325AC7106□M-P		50	X7S	10 μ	±10, ±20	3.5	150		2.5±0.30	

► This catalog contains the typical specification only due to the limitation of space. When you consider the purchase of our products, please check our product specification sheets. For details of each product (characteristics graph, reliability information, precautions for use, and so on), see our website (<http://www.ty-top.com/>).

Multilayer Ceramic Capacitors

PACKAGING

① Minimum Quantity

● Taped package

Type(EIA)	Thickness		Standard quantity [pcs]	
	mm	code	Paper tape	Embossed tape
<input type="checkbox"/> MK021(008004)	0.125	K	—	50000
<input type="checkbox"/> VS021(008004)				
<input type="checkbox"/> MK042(01005)	0.2	C, D	—	40000
<input type="checkbox"/> VS042(01005)				
<input type="checkbox"/> MK063(0201)	0.3	P, T	15000	—
<input type="checkbox"/> WK105(0204) ※	0.3	P	10000	—
<input type="checkbox"/> MK105(0402) <input type="checkbox"/> MF105(0402)	0.13	H	—	20000
	0.18	E	—	15000
	0.2	C	20000	—
	0.3	P	15000	—
	0.5	V	10000	—
<input type="checkbox"/> VK105(0402)	0.5	W	10000	—
<input type="checkbox"/> MK107(0603)	0.45	K	4000	—
<input type="checkbox"/> WK107(0306) ※	0.5	V	—	4000
<input type="checkbox"/> MF107(0603)	0.8	A	4000	—
<input type="checkbox"/> VS107(0603)	0.7	C	4000	—
<input type="checkbox"/> MJ107(0603)	0.8	A	3000	3000
<input type="checkbox"/> MK212(0805)	0.45	K	4000	—
<input type="checkbox"/> WK212(0508) ※	0.85	D		
<input type="checkbox"/> MF212(0805)	1.25	G	—	3000
<input type="checkbox"/> VS212(0805)	0.85	D	4000	—
<input type="checkbox"/> MJ212(0805)	0.85	D	4000	—
	1.25	G	—	2000
<input type="checkbox"/> MK316(1206) <input type="checkbox"/> MF316(1206)	0.85	D	4000	—
	1.15	F	—	3000
	1.6	L	—	2000
<input type="checkbox"/> MJ316(1206)	1.15	F	—	3000
	1.6	L	—	2000
<input type="checkbox"/> MK325(1210) <input type="checkbox"/> MF325(1210)	0.85	D	—	2000
	1.15	F		
	1.9	N		
	2.0max.	Y		
<input type="checkbox"/> MJ325(1210)	2.5	M	—	1000
	1.9	N	—	2000
	2.5	M	—	500(T), 1000(P)
<input type="checkbox"/> MK432(1812)	2.5	M	—	500

Note : ※ LW Reverse type.

② Taping material

※No bottom tape for pressed carrier tape

● Card board carrier tape

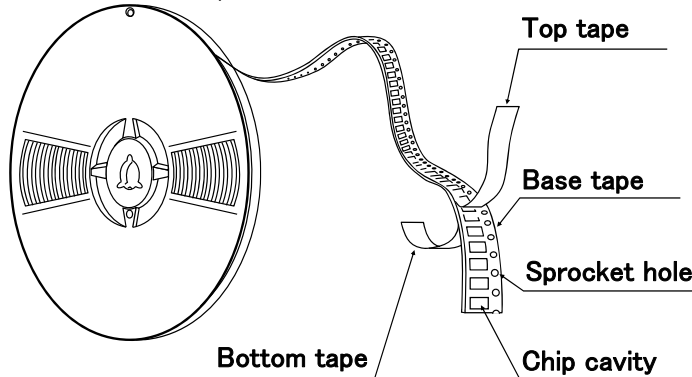

● Embossed tape

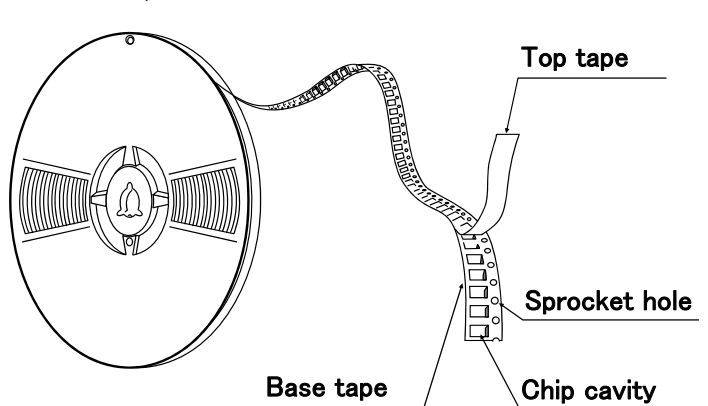

▶ This catalog contains the typical specification only due to the limitation of space. When you consider the purchase of our products, please check our specification. For details of each product (characteristics graph, reliability information, precautions for use, and so on), see our Web site (<http://www.ty-top.com/>).

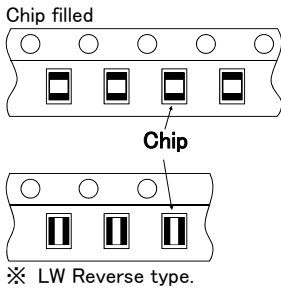

③ Representative taping dimensions

● Paper Tape (8mm wide)

● Pressed carrier tape (2mm pitch)

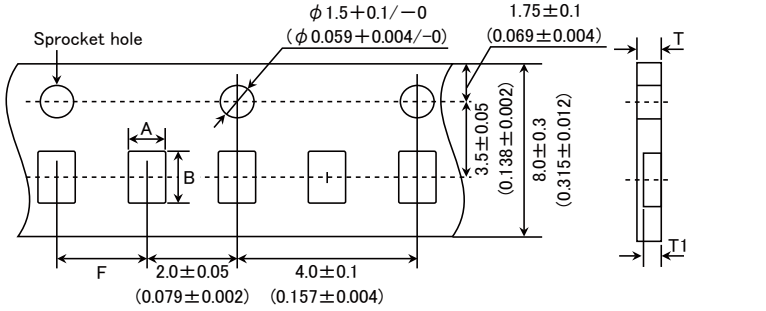

Type(EIA)	Chip Cavity		Insertion Pitch F	Tape Thickness	
	A	B		T	T1
□MK063(0201)	0.37	0.67	2.0±0.05	0.45max.	0.42max.
□WK105(0204) ※	0.65	1.15		0.4max.	0.3max.
□MK105(0402) (*1 C)				0.45max.	0.42max.
□MK105(0402) (*1 P)					

Note *1 Thickness, C: 0.2mm ,P: 0.3mm. ※ LW Reverse type.

Unit: mm

● Punched carrier tape (2mm pitch)

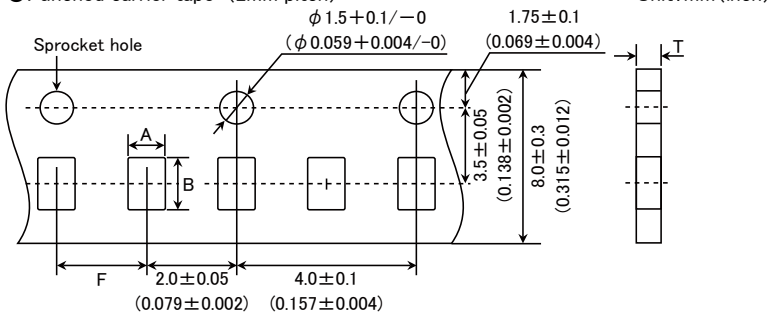

Type(EIA)	Chip Cavity		Insertion Pitch F	Tape Thickness
	A	B		T
□MK105 (0402)	0.65	1.15	2.0±0.05	0.8max.
□MF105 (0402)				
□VK105 (0402)				

Unit: mm

● Punched carrier tape (4mm pitch)

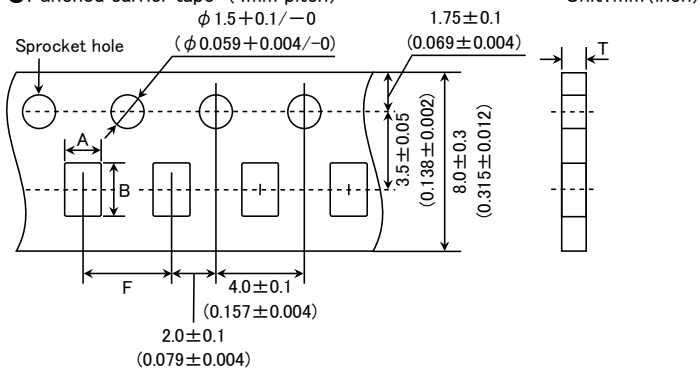

▶ This catalog contains the typical specification only due to the limitation of space. When you consider the purchase of our products, please check our specification. For details of each product (characteristics graph, reliability information, precautions for use, and so on), see our Web site (<http://www.ty-top.com/>).

Type(EIA)	Chip Cavity		Insertion Pitch	Tape Thickness	
	A	B		F	T
□MK107(0603) □WK107(0306) ※ □MF107(0603)	1.0	1.8	4.0±0.1	1.1max.	
□MK212(0805) □WK212(0508) ※	1.65	2.4		1.1max.	
□MK316(1206)	2.0	3.6			

Note: Taping size might be different depending on the size of the product. ※ LW Reverse type.

Unit: mm

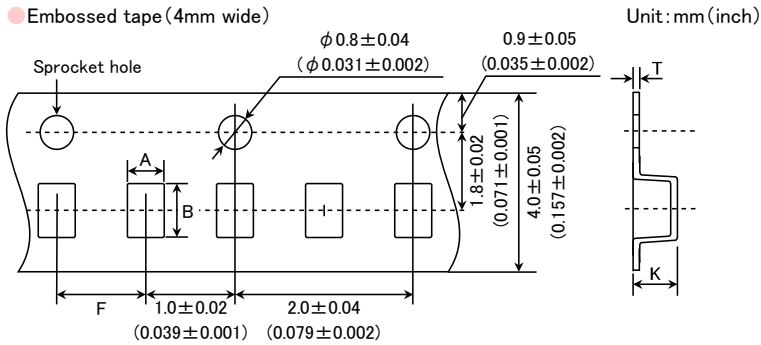

Type(EIA)	Chip Cavity		Insertion Pitch	Tape Thickness	
	A	B		K	T
□MK021(008004) □VS021(008004)	0.135	0.27	1.0±0.02	0.5max.	0.25max.
□MK042(01005) □VS042(01005)					

Unit: mm

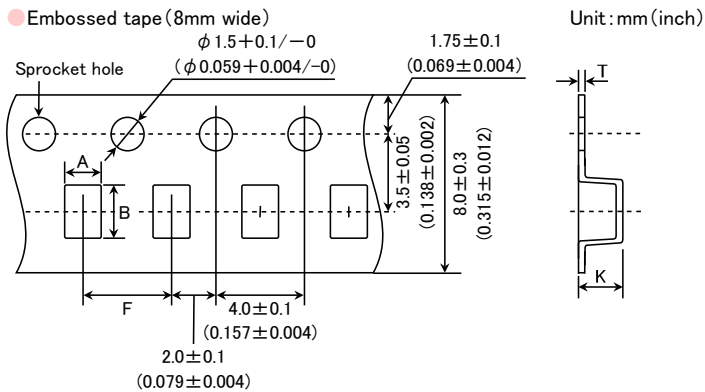

Type(EIA)	Chip Cavity		Insertion Pitch	Tape Thickness	
	A	B		K	T
□MK105(0402)	0.6	1.1	2.0±0.1	0.6max.	0.2±0.1
□WK107(0306) ※ □MK212(0805) □MF212(0805)	1.0	1.8	4.0±0.1	1.3max.	0.25±0.1
□MK316(1206) □MF316(1206)	2.0	3.6		3.4max.	0.6max.
□MK325(1210) □MF325(1210)	2.8	3.6			

Note: ※ LW Reverse type.

Unit: mm

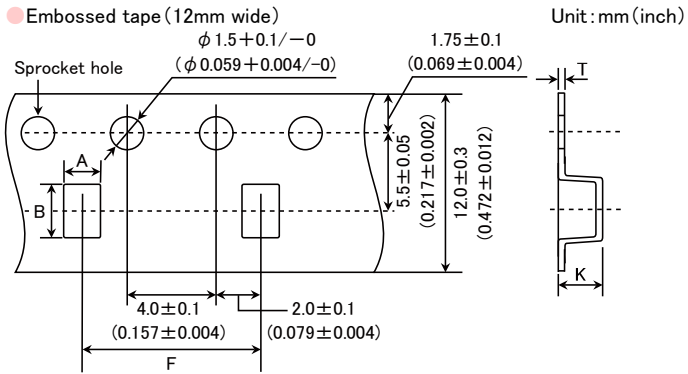

Type(EIA)	Chip Cavity		Insertion Pitch	Tape Thickness	
	A	B	F	K	T
□MK325(1210)	3.1	4.0	8.0±0.1	4.0max.	0.6max.
□MK432(1812)	3.7	4.9	8.0±0.1	4.0max.	0.6max.

Unit: mm

④Trailer and Leader

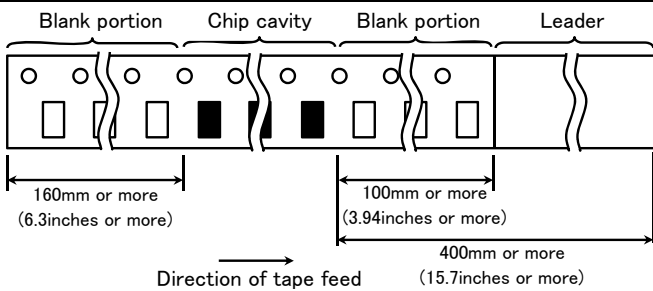

⑤Reel size

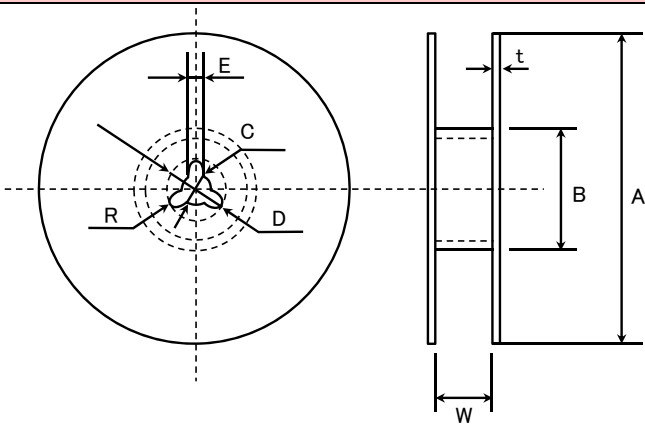

A	B	C	D	E	R
$\phi 178 \pm 2.0$	$\phi 50 \text{ min.}$	$\phi 13.0 \pm 0.2$	$\phi 21.0 \pm 0.8$	2.0 ± 0.5	1.0
	T	W			
4mm wide tape	1.5max.	5 ± 1.0			
8mm wide tape	2.5max.	10 ± 1.5			
12mm wide tape	2.5max.	14 ± 1.5			

Unit: mm

⑥Top Tape Strength

The top tape requires a peel-off force of 0.1 to 0.7N in the direction of the arrow as illustrated below.

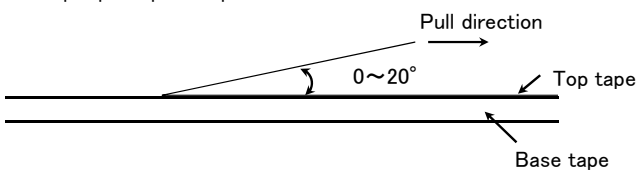

Multilayer Ceramic Capacitors

RELIABILITY DATA

1. Operating Temperature Range				
Specified Value	Temperature Compensating (Class1)	Standard	-55 to +125°C	
		High Frequency Type		
Specified Value	High Permittivity (Class2)		Specification	Temperature Range
		BJ	B	-25 to +85°C
			X5R	-55 to +85°C
		B7	X7R	-55 to +125°C
		C6	X6S	-55 to +105°C
		C7	X7S	-55 to +125°C
		D7	X7T	-55 to +125°C
		LD(※)	X5R	-55 to +85°C
Note: ※LD Low distortion high value multilayer ceramic capacitor				

2. Storage Conditions				
Specified Value	Temperature Compensating (Class1)	Standard	-55 to +125°C	
		High Frequency Type		
Specified Value	High Permittivity (Class2)		Specification	Temperature Range
		BJ	B	-25 to +85°C
			X5R	-55 to +85°C
		B7	X7R	-55 to +125°C
		C6	X6S	-55 to +105°C
		C7	X7S	-55 to +125°C
		D7	X7T	-55 to +125°C
		LD(※)	X5R	-55 to +85°C
Note: ※LD Low distortion high value multilayer ceramic capacitor				

3. Rated Voltage			
Specified Value	Temperature Compensating (Class1)	Standard	50VDC, 25VDC
		High Frequency Type	50VDC, 25VDC
	High Permittivity (Class2)		50VDC, 35VDC, 25VDC, 16VDC, 10VDC, 6.3VDC, 4VDC, 2.5VDC

4. Withstanding Voltage (Between terminals)			
Specified Value	Temperature Compensating (Class1)	Standard	No breakdown or damage
		High Frequency Type	
	High Permittivity (Class2)		
Test Methods and Remarks		Class 1	Class 2
	Applied voltage	Rated volta × 3	Rated voltage × 2.5
	Duration	1 to 5 sec.	
	Charge/discharge current	50mA max.	

5. Insulation Resistance			
Specified Value	Temperature Compensating (Class1)	Standard	10000 MΩ min.
		High Frequency Type	
	High Permittivity (Class2) Note 1		C ≤ 0.047 μF : 10000 MΩ min. C > 0.047 μF : 500MΩ · μF
Test Methods and Remarks	Applied voltage	: Rated voltage	
	Duration	: 60 ± 5 sec.	
	Charge/discharge current	: 50mA max.	

▶ This catalog contains the typical specification only due to the limitation of space. When you consider the purchase of our products, please check our specification. For details of each product (characteristics graph, reliability information, precautions for use, and so on), see our Web site (<http://www.ty-top.com/>).

6. Capacitance (Tolerance)				
Specified Value	Temperature Compensating(Class1)	Standard	C□	0.2pF ≤ C ≤ 5pF : ±0.25pF
			U□	0.2pF ≤ C ≤ 10pF : ±0.5pF
			SL	C > 10pF : ±5% or ±10%
		High Frequency Type	CH	0.3pF ≤ C ≤ 2pF : ±0.1pF C > 2pF : ±5%
	High Permittivity (Class2)		BJ, B7, C6, C7, D7, LD(※) : ±10% or ±20% Note: ※LD Low distortion high value multilayer ceramic capacitor	
Test Methods and Remarks			Class 1	
			Standard	High Frequency Type
			Class 2	
			C ≤ 10 μF	C > 10 μF
	Preconditioning		None	
Measuring frequency		Thermal treatment (at 150°C for 1hr) Note 2		
Measuring voltage Note		1MHz ± 10%	1kHz ± 10%	120 ± 10Hz
Measuring voltage Note		0.5 to 5Vrms	1 ± 0.2Vrms	0.5 ± 0.1rms
Bias application		None		

7. Q or Dissipation Factor				
Specified Value	Temperature Compensating(Class1)	Standard	C < 30pF : Q ≥ 400 + 20C C ≥ 30pF : Q ≥ 1000 (C: Nominal capacitance)	
			High Frequency Type	Refer to detailed specification
	High Permittivity (Class2) Note 1		BJ, B7, C6, C7, D7: 2.5% max.	
Test Methods and Remarks			Class 1	
			Standard	High Frequency Type
			Class 2	
			C ≤ 10 μF	C > 10 μF
	Preconditioning		None	
Measuring frequency		Thermal treatment (at 150°C for 1hr) Note 2		
Measuring voltage Note 1		1MHz ± 10%	1GHz	1kHz ± 10%
Measuring voltage Note 1		0.5 to 5Vrms	1 ± 0.2Vrms	0.5 ± 0.1Vrms
Bias application		None		
High Frequency Type Measuring equipment : HP4291A Measuring jig : HP16192A				

8. Temperature Characteristic (Without voltage application)						
Specified Value	Temperature Compensating(Class1)	Standard	Temperature Characteristic [ppm/°C]		Tolerance [ppm/°C]	
			C□ : 0	CG, CH, C, J, CK	G : ±30 H : ±60 J : ±120 K : ±250	
			U□ : -750	UJ, UK		
			SL : +350 to -1000			
		High Frequency Type	Temperature Characteristic [ppm/°C]		Tolerance [ppm/°C]	
			C□ : 0		H : ±60	
High Permittivity (Class2)			Specification	Capacitance change	Reference temperature	Temperature Range
			B	±10%	20°C	-25 to +85°C
			X5R	±15%	25°C	-55 to +85°C
			X7R	±15%	25°C	-55 to +125°C
			X6S	±22%	25°C	-55 to +105°C
			X7S	±22%	25°C	-55 to +125°C
			X7S	+22/-33%	25°C	-55 to +125°C
			LD(※) X5R	±15%	25°C	-55 to +85°C
Note : ※LD Low distortion high value multilayer ceramic capacitor						

Test Methods and Remarks	Class 1 : Capacitance at 20°C and 85°C shall be measured in thermal equilibrium, and the temperature characteristic shall be calculated from the following equation.				
	$\frac{(C_{85} - C_{20})}{C_{20} \times \Delta T} \times 10^6 (\text{ppm}/^\circ\text{C}) \quad \Delta T = 65$				
	Class 2 : Capacitance at each step shall be measured in thermal equilibrium, and the temperature characteristic shall be calculated from the following equation.				
	Step	B	X5R, X7R, X6S, X7S, X7T		
	1	Minimum operating temperature			
2	20°C	25°C			
3	Maximum operating temperature				
$\frac{(C - C_2)}{C_2} \times 100 (\%)$					
C : Capacitance in Step 1 or Step 3 C2 : Capacitance in Step 2					

▶ This catalog contains the typical specification only due to the limitation of space. When you consider the purchase of our products, please check our specification. For details of each product (characteristics graph, reliability information, precautions for use, and so on), see our Web site (<http://www.ty-top.com/>).

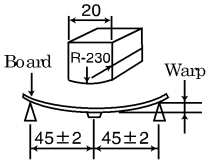
9. Deflection																				
Specified Value	Temperature Compensating(Class1)	Standard	Appearance : No abnormality Capacitance change : Within $\pm 5\%$ or ± 0.5 pF, whichever is larger.																	
		High Frequency Type	Appearance : No abnormality Capaitance change : Within ± 0.5 pF																	
	High Permittivity (Class2)		Appearance : No abnormality Capacitance change : Within $\pm 12.5\%$ (BJ, B7, C6, C7, D7, LD(※)) Note: ※LD Low distortion high value multilayer ceramic capacitor																	
Test Methods and Remarks	<table border="1"> <thead> <tr> <th rowspan="2"></th> <th colspan="2">Multilayer Ceramic Capacitors</th> </tr> <tr> <th>042, 063, ※1105 Type</th> <th>The other types</th> </tr> </thead> <tbody> <tr> <td>Board</td> <td colspan="2">Glass epoxy-resin substrate</td> </tr> <tr> <td>Thickness</td> <td>0.8mm</td> <td>1.6mm</td> </tr> <tr> <td>Warp</td> <td colspan="2">1mm (Soft Termination type:3mm)</td> </tr> <tr> <td>Duration</td> <td colspan="2">10 sec.</td> </tr> </tbody> </table>			Multilayer Ceramic Capacitors		042, 063, ※1105 Type	The other types	Board	Glass epoxy-resin substrate		Thickness	0.8mm	1.6mm	Warp	1mm (Soft Termination type:3mm)		Duration	10 sec.		 <p>(Unit: mm)</p> <p>Capacitance measurement shall be conducted with the board bent</p>
		Multilayer Ceramic Capacitors																		
042, 063, ※1105 Type		The other types																		
Board	Glass epoxy-resin substrate																			
Thickness	0.8mm	1.6mm																		
Warp	1mm (Soft Termination type:3mm)																			
Duration	10 sec.																			
※1:105 Type thickness, C: 0.2mm, P: 0.3mm.																				

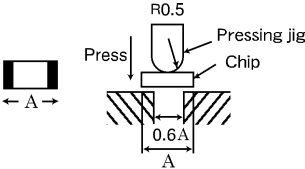
10. Body Strength			
Specified Value	Temperature Compensating(Class1)	Standard	—
		High Frequency Type	No mechanical damage.
	High Permittivity (Class2)		—
Test Methods and Remarks	High Frequency Type	Applied force : 5N Duration : 10 sec.	

11. Adhesive Strength of Terminal Electrodes														
Specified Value	Temperature Compensating(Class1)	Standard	No terminal separation or its indication.											
		High Frequency Type												
	High Permittivity (Class2)													
Test Methods and Remarks	<table border="1"> <thead> <tr> <th rowspan="2"></th> <th colspan="2">Multilayer Ceramic Capacitors</th> </tr> <tr> <th>042, 063 Type</th> <th>105 Type or more</th> </tr> </thead> <tbody> <tr> <td>Applied force</td> <td>2N</td> <td>5N</td> </tr> <tr> <td>Duration</td> <td colspan="2">30±5 sec.</td> </tr> </tbody> </table>			Multilayer Ceramic Capacitors		042, 063 Type	105 Type or more	Applied force	2N	5N	Duration	30±5 sec.		
		Multilayer Ceramic Capacitors												
		042, 063 Type	105 Type or more											
Applied force	2N	5N												
Duration	30±5 sec.													

12. Solderability															
Specified Value	Temperature Compensating(Class1)	Standard	At least 95% of terminal electrode is covered by new solder.												
		High Frequency Type													
	High Permittivity (Class2)														
Test Methods and Remarks	<table border="1"> <thead> <tr> <th rowspan="2"></th> <th>Eutectic solder</th> <th>Lead-free solder</th> </tr> </thead> <tbody> <tr> <td>Solder type</td> <td>H60A or H63A</td> <td>Sn-3.0Ag-0.5Cu</td> </tr> <tr> <td>Solder temperature</td> <td>230±5°C</td> <td>245±3°C</td> </tr> <tr> <td>Duration</td> <td colspan="2">4±1 sec.</td> </tr> </tbody> </table>			Eutectic solder	Lead-free solder	Solder type	H60A or H63A	Sn-3.0Ag-0.5Cu	Solder temperature	230±5°C	245±3°C	Duration	4±1 sec.		
		Eutectic solder		Lead-free solder											
		Solder type	H60A or H63A	Sn-3.0Ag-0.5Cu											
	Solder temperature	230±5°C	245±3°C												
Duration	4±1 sec.														

▶ This catalog contains the typical specification only due to the limitation of space. When you consider the purchase of our products, please check our specification. For details of each product (characteristics graph, reliability information, precautions for use, and so on), see our Web site (<http://www.ty-top.com/>).

13. Resistance to Soldering

Specified Value	Temperature Compensating(Class1)	Standard	Appearance : No abnormality Capacitance change : Within $\pm 2.5\%$ or $\pm 0.25\text{pF}$, whichever is larger. Q : Initial value Insulation resistance : Initial value Withstanding voltage (between terminals) : No abnormality
		High Frequency Type	Appearance : No abnormality Capacitance change : Within $\pm 2.5\%$ Q : Initial value Insulation resistance : Initial value Withstanding voltage (between terminals) : No abnormality
	High Permittivity (Class2) Note 1		Appearance : No abnormality Capacitance change : Within $\pm 7.5\%$ (BJ, B7, C6, C7, D7, LD(※)) Dissipation factor : Initial value Insulation resistance : Initial value Withstanding voltage (between terminals): No abnormality Note: ※LD Low distortion high value multilayer ceramic capacitor

Test Methods and Remarks	Class 1			
		042, 063 Type	105 Type	
	Preconditioning	None		
	Preheating	150°C, 1 to 2 min.	80 to 100°C, 2 to 5 min. 150 to 200°C, 2 to 5 min.	
	Solder temp.	270 \pm 5°C		
	Duration	3 \pm 0.5 sec.		
	Recovery	6 to 24 hrs (Standard condition) Note 5		
	Class 2			
		042, 063 Type	105, 107, 212 Type	316, 325 Type
	Preconditioning	Thermal treatment (at 150°C for 1 hr) Note 2		
	Preheating	150°C, 1 to 2 min.	80 to 100°C, 2 to 5 min. 150 to 200°C, 2 to 5 min.	80 to 100°C, 5 to 10 min. 150 to 200°C, 5 to 10 min.
	Solder temp.	270 \pm 5°C		
	Duration	3 \pm 0.5 sec.		
	Recovery	24 \pm 2 hrs (Standard condition) Note 5		

14. Temperature Cycle (Thermal Shock)

Specified Value	Temperature Compensating(Class1)	Standard	Appearance : No abnormality Capacitance change : Within $\pm 2.5\%$ or $\pm 0.25\text{pF}$, whichever is larger. Q : Initial value Insulation resistance : Initial value Withstanding voltage (between terminals) : No abnormality
		High Frequency Type	Appearance : No abnormality Capacitance change : Within $\pm 0.25\text{pF}$ Q : Initial value Insulation resistance : Initial value Withstanding voltage (between terminals) : No abnormality
	High Permittivity (Class2) Note 1		Appearance : No abnormality Capacitance change : Within $\pm 7.5\%$ (BJ, B7, C6, C7, D7, LD(※)) Dissipation factor : Initial value Insulation resistance : Initial value Withstanding voltage (between terminals) : No abnormality Note: ※LD Low distortion high value multilayer ceramic capacitor

Test Methods and Remarks	Class 1		Class 2		
	Preconditioning	Thermal treatment (at 150°C for 1 hr) Note 2			
	1 cycle	None			
			Step	Temperature (°C)	Time (min.)
			1	Minimum operating temperature	30 \pm 3
			2	Normal temperature	2 to 3
	3	Maximum operating temperature	30 \pm 3		
	4	Normal temperature	2 to 3		
Number of cycles	5 times				
Recovery	6 to 24 hrs (Standard condition) Note 5		24 \pm 2 hrs (Standard condition) Note 5		

▶ This catalog contains the typical specification only due to the limitation of space. When you consider the purchase of our products, please check our specification. For details of each product (characteristics graph, reliability information, precautions for use, and so on), see our Web site (<http://www.ty-top.com/>).

15. Humidity (Steady State)					
Specified Value	Temperature Compensating(Class1)	Standard	Appearance : No abnormality Capacitance change : Within $\pm 5\%$ or $\pm 0.5\text{pF}$, whichever is larger. Q : $C < 10\text{pF} : Q \geq 200 + 10C$ $10 \leq C < 30\text{pF} : Q \geq 275 + 2.5C$ $C \geq 30\text{pF} : Q \geq 350 (C : \text{Nominal capacitance})$ Insulation resistance : 1000 M Ω min.		
		High Frequency Type	Appearance : No abnormality Capacitance change : Within $\pm 0.5\text{pF}$, Insulation resistance : 1000 M Ω min.		
	High Permittivity (Class2) Note 1		Appearance : No abnormality Capacitance change : Within $\pm 12.5\%$ (BJ, B7, C6, C7, D7, LD(※)) Dissipation factor : 5.0% max. (BJ, B7, C6, C7, D7, LD(※)) Insulation resistance : 50 M Ω μF or 1000 M Ω whichever is smaller. Note: ※LD Low distortion high value multilayer ceramic capacitor		
Test Methods and Remarks		Class 1		Class 2	
		Standard	High Frequency Type	All items	
	Preconditioning	None			Thermal treatment (at 150°C for 1 hr) Note 2
	Temperature	40 \pm 2°C	60 \pm 2°C	40 \pm 2°C	
	Humidity	90 to 95%RH		90 to 95%RH	
	Duration	500+24/-0 hrs		500+24/-0 hrs	
	Recovery	6 to 24 hrs (Standard condition) Note 5		24 \pm 2 hrs (Standard condition) Note 5	

16. Humidity Loading					
Specified Value	Temperature Compensating(Class1)	Standard	Appearance : No abnormality Capacitance change : Within $\pm 7.5\%$ or $\pm 0.75\text{pF}$, whichever is larger. Q : $C < 30\text{pF} : Q \geq 100 + 10C/3$ $C \geq 30\text{pF} : Q \geq 200 (C : \text{Nominal capacitance})$ Insulation resistance : 500 M Ω min.		
		High Frequency Type	Appearance : No abnormality Capacitance change : $C \leq 2\text{pF} : \text{Within } \pm 0.4 \text{ pF}$ $C > 2\text{pF} : \text{Within } \pm 0.75 \text{ pF} (C : \text{Nominal capacitance})$ Insulation resistance : 500 M Ω min.		
	High Permittivity (Class2) Note 1		Appearance : No abnormality Capacitance change : Within $\pm 12.5\%$ (BJ, B7, C6, C7, D7, LD(※)) Dissipation factor : 5.0% max. (BJ, B7, C6, C7, D7, LD(※)) Insulation resistance : 25 M Ω μF or 500 M Ω , whichever is smaller. Note: ※LD Low distortion high value multilayer ceramic capacitor		
Test Methods and Remarks		Class 1		Class 2	
		Standard	High Frequency Type	All items	
	Preconditioning	None			Voltage treatment (Rated voltage are applied for 1 hour at 40°C) Note 3
	Temperature	40 \pm 2°C	60 \pm 2°C	40 \pm 2°C	
	Humidity	90 to 95%RH		90 to 95%RH	
	Duration	500+24/-0 hrs		500+24/-0 hrs	
	Applied voltage	Rated voltage		Rated voltage	
	Charge/discharge current	50mA max.		50mA max.	
Recovery	6 to 24 hrs (Standard condition) Note 5		24 \pm 2 hrs (Standard condition) Note 5		

17. High Temperature Loading

► This catalog contains the typical specification only due to the limitation of space. When you consider the purchase of our products, please check our specification.
For details of each product (characteristics graph, reliability information, precautions for use, and so on), see our Web site (<http://www.ty-top.com/>).

Specified Value	Temperature Compensating(Class1)	Standard	Appearance : No abnormality Capacitance change : Within $\pm 3\%$ or $\pm 0.3\text{pF}$, whichever is larger. Q : $C < 10\text{pF}$: $Q \geq 200 + 10C$ $10 \leq C < 30\text{pF}$: $Q \geq 275 + 2.5C$ $C \geq 30\text{pF}$: $Q \geq 350$ (C: Nominal capacitance) Insulation resistance : $1000 \text{ M}\Omega$ min.
		High Frequency Type	Appearance : No abnormality Capacitance change : Within $\pm 3\%$ or $\pm 0.3\text{pF}$, whichever is larger. Insulation resistance : $1000 \text{ M}\Omega$ min.
	High Permittivity (Class2) Note 1		Appearance : No abnormality Capacitance change : Within $\pm 12.5\%$ (BJ, B7, C6, C7, D7, LD(※)) Dissipation factor : 5.0% max. (BJ, B7, C6, C7, D7, LD(※)) Insulation resistance : $50 \text{ M}\Omega \mu\text{F}$ or $1000 \text{ M}\Omega$, whichever is smaller. Note: ※LD Low distortion high value multilayer ceramic capacitor

Test Methods and Remarks		Class 1		Class 2		
		Standard	High Frequency Type	BJ, LD(※)	C6	B7, C7, D7
	Preconditioning	None		Voltage treatment (Twice the rated voltage shall be applied for 1 hour at 85°C, 105°C or 125°C) Note 3, 4		
	Temperature	Maximum operating temperature		Maximum operating temperature		
	Duration	1000+48/-0 hrs		1000+48/-0 hrs		
	Applied voltage	Rated voltage $\times 2$		Rated voltage $\times 2$ Note 4		
	Charge/discharge current	50mA max.		50mA max.		
	Recovery	6 to 24hr (Standard condition) Note 5		24 \pm 2 hrs (Standard condition) Note 5		
Note: ※LD Low distortion high value multilayer ceramic capacitor						

Note 1 The figures indicate typical specifications. Please refer to individual specifications in detail.

Note 2 Thermal treatment : Initial value shall be measured after test sample is heat-treated at $150 \pm 0 / -10^\circ\text{C}$ for an hour and kept at room temperature for 24 ± 2 hours.

Note 3 Voltage treatment : Initial value shall be measured after test sample is voltage-treated for an hour at both the temperature and voltage specified in the test conditions, and kept at room temperature for 24 ± 2 hours.

Note 4 150% of rated voltage is applicable to some items. Please refer to their specifications for further information.

Note 5 Standard condition: Temperature: 5 to 35°C, Relative humidity: 45 to 85 % RH, Air pressure: 86 to 106kPa When there are questions concerning measurement results, in order to provide correlation data, the test shall be conducted under the following condition.

Temperature: $20 \pm 2^\circ\text{C}$, Relative humidity: 60 to 70 % RH, Air pressure: 86 to 106kPa Unless otherwise specified, all the tests are conducted under the "standard condition".

Medium-High Voltage Multilayer Ceramic Capacitor

RELIABILITY DATA

1. Operating Temperature Range	
Specified Value	Temperature Compensating(High Frequency type) CG(C0G) : -55 to +125°C
	High permittivity X7R, X7S : -55 to +125°C X5 : -55 to +85°C B : -25 to +85°C
2. Storage Temperature Range	
Specified Value	Temperature Compensating(High Frequency type) CG(C0G) : -55 to +125°C
	High permittivity X7R, X7S : -55 to +125°C X5R : -55 to +85°C B : -25 to +85°C
3. Rated Voltage	
Specified Value	100VDC(HMK, HMJ), 250VDC(QMK, QMJ, QVS), 630VDC(SMK, SMJ)
4. Withstanding Voltage (Between terminals)	
Specified Value	No breakdown or damage
Test Methods and Remarks	Applied voltage : Rated voltage × 2.5 (HMK, HMJ), Rated voltage × 2 (QMK, QMJ, QVS), Rated voltage × 1.2 (SMK, SMJ) Duration : 1 to 5sec. Charge/discharge current : 50mA max.
5. Insulation Resistance	
Specified Value	Temperature Compensating(High Frequency type) 10000MΩ min
	High permittivity 100MΩ μF or 10GΩ, whichever is smaller.
Test Methods and Remarks	Applied voltage : Rated voltage (HMK, HMJ, QMK, QMJ, QVS), 500V (SMK, SMJ) Duration : 60 ± 5sec. Charge/discharge current : 50mA max.
6. Capacitance (Tolerance)	
Specified Value	Temperature Compensating(High Frequency type) ±0.1pF (C < 5pF) ±0.25pF (C < 10pF) ±0.5pF (5pF ≤ C < 10pF) ±2%(C=10pF) ±5%(C ≥ 10pF)
	High permittivity ±10%, ±20%
Test Methods and Remarks	Temperature Compensating(High Frequency type) Measuring frequency : 1MHz ± 10% Measuring voltage : 0.5 to 5Vrms Bias application : None
	High permittivity Measuring frequency : 1kHz ± 10% Measuring voltage : 1 ± 0.2Vrms Bias application : None

▶ This catalog contains the typical specification only due to the limitation of space. When you consider the purchase of our products, please check our specification.
For details of each product (characteristics graph, reliability information, precautions for use, and so on), see our Web site (<http://www.ty-top.com/>).

7. Q or Dissipation Factor	
Specified Value	Temperature Compensating(High Frequency type) $C < 30\text{pF} : Q \geq 800 + 20C$ $C \geq 30\text{pF} : Q \geq 1400$ C:Normal Capacitance(/pF) High permittivity 3.5%max (HMK,HMJ) 2.5%max (QMK,QMJ, SMK,SMJ)
Test Methods and Remarks	Temperature Compensating(High Frequency type) Measuring frequency : 1MHz±10% Measuring voltage : 0.5 to 5Vrms Bas application : None High permittivity Measuring frequency : 1kHz±10% Measuring voltage : 1±0.2Vrms Bas application : None

8. Temperature Characteristic of Capacitance

Specified Value	Temperature Compensating(High Frequency type) C0G : ±30ppm(25 to +125°C) High permittivity B : ±10% (-25 to +85°C) X5R : ±15% (-55 to +85°C) X7R : ±15% (-55 to +125°C) X7S : ±22% (-55 to +125°C)												
Test Methods and Remarks	Temperature Compensating(High Frequency type) Capacitance at 25°C and 85°C shall be measured in thermal equilibrium, and the temperature characteristic shall be calculated from the following equation. $\frac{(C_{85} - C_{25})}{C_{25} \times \Delta T} \times 10^6 \times [\text{ppm}/^\circ\text{C}]$ High permittivity Capacitance value at each step shall be measured in thermal equilibrium, and the temperature characteristic shall be calculated from the following equation. <table border="1" style="margin-left: 20px;"> <thead> <tr> <th>Step</th> <th>B</th> <th>X5R, X7R, X7S</th> </tr> </thead> <tbody> <tr> <td>1</td> <td colspan="2">Minimum operating temperature</td> </tr> <tr> <td>2</td> <td>20°C</td> <td>25°C</td> </tr> <tr> <td>3</td> <td colspan="2">Maximum operating temperature</td> </tr> </tbody> </table> $\frac{(C - C_2)}{C_2} \times 100 (\%)$ C : Capacitance value in Step 1 or Step 3 C2 : Capacitance value in Step 2	Step	B	X5R, X7R, X7S	1	Minimum operating temperature		2	20°C	25°C	3	Maximum operating temperature	
Step	B	X5R, X7R, X7S											
1	Minimum operating temperature												
2	20°C	25°C											
3	Maximum operating temperature												

9. Deflection

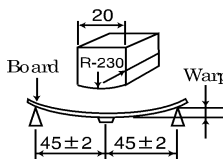
Specified Value	Temperature Compensating(High Frequency type) Appearance : No abnormality Capacitance change : ±5% or ±0.5pF, whichever is larger. High permittivity Appearance : No abnormality Capacitance change : Within ±10%
Test Methods and Remarks	Warp : 1mm (Soft Termination type:3mm) Duration : 10sec. Test board : Glass epoxy-resin substrate Thicknss : 1.6mm <div style="text-align: center;">  <p>(Unit: mm)</p> </div> Capacitance measurement shall be conducted with the board bent.

▶ This catalog contains the typical specification only due to the limitation of space. When you consider the purchase of our products, please check our specification. For details of each product (characteristics graph, reliability information, precautions for use, and so on), see our Web site (<http://www.ty-top.com/>).

10. Adhesive Strength of Terminal Electrodes

Specified Value	No terminal separation or its indication.
Test Methods and Remarks	Temperature Compensating(High Frequency type) Applied force : 2N Duration : 10±1sec.
	High permittivity Applied force : 5N Duration : 30±5sec.

11. Solderability

Specified Value	At least 95% of terminal electrode is covered by new solder		
Test Methods and Remarks		Eutectic solder	Lead-free solder
	Solder type	H60A or H63A	Sn-3.0Ag-0.5Cu
	Solder temperature	230±5°C	245±3°C
	Duration	4±1 sec.	

12. Resistance to Soldering

Specified Value	Temperature Compensating(High Frequency type) Appearance : No abnormality Capacitance change : C※ ≤ 10pF : ±0.25pF C※ > 10pF : ±2.5% ※Normal capacitance Insulation resistance : Initial value Withstanding voltage (between terminals) : No abnormality
	High permittivity Appearance : No abnormality Capacitance change : Within ±15% (HMK, HMJ), ±10% (QMK, QMJ, SMK, SMJ) Dissipation factor : Initial value Insulation resistance : Initial value Withstanding voltage (between terminals) : No abnormality
Test Methods and Remarks	Preconditioning : Thermal treatment (at 150°C for 1hr) Note1 (Only High permittivity) Solder temperature : 270±5°C Duration : 3±0.5sec. Preheating conditions : 80 to 100°C, 2 to 5 min. 150 to 200°C, 2 to 5min. Recovery : 24±2hrs under the stadard condition Note3

13. Temperature Cycle (Thermal Shock)

Specified Value	Temperature Compensating(High Frequency type) Appearance : No abnormality Capacitance change : C※ ≤ 10pF : ±0.25% C※ > 10pF : ±2.5% Insulation resistance : Initial value Withstanding voltage (between terminals) : No abnormality														
	High permittivity Appearance : No abnormality Capacitance change : Within ±15% (HMK, HMJ), ±7.5% (QMK, QMJ, SMK, SMJ) Dissipation factor : Initial value Insulation resistance : Initial value Withstanding voltage (between terminals) : No abnormality														
Test Methods and Remarks	Preconditioning : Thermal treatment (at 150°C for 1hr) Note1 Conditions for 1 cycle														
	<table border="1"> <thead> <tr> <th>Step</th> <th>temperature (°C)</th> <th>Time (min.)</th> </tr> </thead> <tbody> <tr> <td>1</td> <td>Minimum operating temperature</td> <td>30±3min.</td> </tr> <tr> <td>2</td> <td>Normal temperature</td> <td>2 to 3min.</td> </tr> <tr> <td>3</td> <td>Maximum operating temperature</td> <td>30±3min.</td> </tr> <tr> <td>4</td> <td>Normal temperature</td> <td>2 to 3min.</td> </tr> </tbody> </table> <p>Number of cycles : 5 times Recovery : 24±2hrs under the standard condition Note3</p>	Step	temperature (°C)	Time (min.)	1	Minimum operating temperature	30±3min.	2	Normal temperature	2 to 3min.	3	Maximum operating temperature	30±3min.	4	Normal temperature
Step	temperature (°C)	Time (min.)													
1	Minimum operating temperature	30±3min.													
2	Normal temperature	2 to 3min.													
3	Maximum operating temperature	30±3min.													
4	Normal temperature	2 to 3min.													

▶ This catalog contains the typical specification only due to the limitation of space. When you consider the purchase of our products, please check our specification. For details of each product (characteristics graph, reliability information, precautions for use, and so on), see our Web site (<http://www.ty-top.com/>).

14. Humidity (Steady state)	
Specified Value	Temperature Compensating(High Frequency type) Appearance : No abnormality Capacitance change : C※ ≤ 10pF : ±0.5pF C※ > 10pF : ±5% ※Normal capacitance Insulation resistance : 1000MΩ min
	High permittivity Appearance : No abnormality Capacitance change : Within ±15% Dissipation factor : 7%max (HMK, HMJ), 5%max (QMK, QMJ, SMK, SMJ). Insulation resistance : 25MΩ μF or 1000MΩ, whichever is smaller.
Test Methods and Remarks	Preconditioning : Thermal treatment (at 150°C for 1hr) Note1 (Only High permittivity) Temperature : 40 ± 2°C Humidity : 90 to 95%RH Duration : 500 +24/−0 hrs Recovery : 24 ± 2hrs under the standard condition Note3

15. Humidity Loading	
Specified Value	Temperature Compensating(High Frequency type) Appearance : No abnormality Capacitance change : C※ ≤ 2.0pF : ±0.4pF 2.0pF < C ≤ 10pF : ±0.75pF C※ > 10pF : ±7.5% ※Normal capacitance Insulation resistance : 500MΩ min
	High permittivity Appearance : No abnormality Capacitance change : Within ±15% Dissipation factor : 7%max (HMK, HMJ), 5%max (QMK, QMJ, SMK, SMJ). Insulation resistance : 10MΩ μF or 500MΩ, whichever is smaller.
Test Methods and Remarks	According to JIS 5102 clause 9.9. Preconditioning : Voltage treatment Note2 (Only High permittivity) Temperature : 40 ± 2°C Humidity : 90 to 95%RH Applied voltage : Rated voltage Charge/discharge current : 50mA max. Duration : 500 +24/−0 hrs Recovery : 24 ± 2hrs under the standard condition Note3

16. High Temperature Loading	
Specified Value	Temperature Compensating(High Frequency type) Appearance : No abnormality Capacitance change : C※ ≤ 10pF : ±0.3pF C※ > 10pF : ±3% Insulation resistance : 1000MΩ min
	High permittivity Appearance : No abnormality Capacitance change : Within ±15% Dissipation factor : 7%max (HMK, HMJ), 5%max (QMK, QMJ, SMK, SMJ). Insulation resistance : 50MΩ μF or 1000MΩ, whichever is smaller.
Test Methods and Remarks	According to JIS 5102 clause 9.10. Preconditioning : Voltage treatment Note2 (Only High permittivity) Temperature : Maximum operating temperature Applied voltage : Rated voltage × 2 (HMK, HMJ, QVS) Rated voltage × 1.5 (QMK, QMJ) Rated voltage × 1.2 (SMK, SMJ) Charge/discharge current : 50mA max. Duration : 1000 +24/−0 hrs Recovery : 24 ± 2hrs under the standard condition Note3

Note1 Thermal treatment : Initial value shall be measured after test sample is heat-treated at 150+0/−10°C for an hour and kept at room temperature for 24±2hours.

Note2 Voltage treatment : Initial value shall be measured after test sample is voltage-treated for an hour at both the temperature and voltage specified in the test conditions, and kept at room temperature for 24±2hours.

Note3 Standard condition : Temperature: 5 to 35°C, Relative humidity: 45 to 85 % RH, Air pressure: 86 to 106kPa
When there are questions concerning measurement results, in order to provide correlation data, the test shall be conducted under the following condition.

Temperature: 20 ± 2°C, Relative humidity: 60 to 70 % RH, Air pressure: 86 to 106kPa
Unless otherwise specified, all the tests are conducted under the "standard condition".

Precautions on the use of Multilayer Ceramic Capacitors

PRECAUTIONS

1. Circuit Design

Precautions

- ◆ Verification of operating environment, electrical rating and performance
 1. A malfunction of equipment in fields such as medical, aerospace, nuclear control, etc. may cause serious harm to human life or have severe social ramifications. Therefore, any capacitors to be used in such equipment may require higher safety and reliability, and shall be clearly differentiated from them used in general purpose applications.
- ◆ Operating Voltage (Verification of Rated voltage)
 1. The operating voltage for capacitors must always be their rated voltage or less.
 - If an AC voltage is loaded on a DC voltage, the sum of the two peak voltages shall be the rated voltage or less.
 - For a circuit where an AC or a pulse voltage may be used, the sum of their peak voltages shall also be the rated voltage or less.
 2. Even if an applied voltage is the rated voltage or less reliability of capacitors may be deteriorated in case that either a high frequency AC voltage or a pulse voltage having rapid rise time is used in a circuit.

2. PCB Design

Precautions

- ◆ Pattern configurations (Design of Land-patterns)
 1. When capacitors are mounted on PCBs, the amount of solder used (size of fillet) can directly affect the capacitor performance. Therefore, the following items must be carefully considered in the design of land patterns:
 - (1) Excessive solder applied can cause mechanical stresses which lead to chip breaking or cracking. Therefore, please consider appropriate land-patterns for proper amount of solder.
 - (2) When more than one component are jointly soldered onto the same land, each component's soldering point shall be separated by solder-resist.
- ◆ Pattern configurations (Capacitor layout on PCBs)

After capacitors are mounted on boards, they can be subjected to mechanical stresses in subsequent manufacturing processes (PCB cutting, board inspection, mounting of additional parts, assembly into the chassis, wave soldering of the boards, etc.). For this reason, land pattern configurations and positions of capacitors shall be carefully considered to minimize stresses.

Technical considerations

- ◆ Pattern configurations (Design of Land-patterns)

The following diagrams and tables show some examples of recommended land patterns to prevent excessive solder amounts.

(1) Recommended land dimensions for typical chip capacitors

- Multilayer Ceramic Capacitors : Recommended land dimensions (unit: mm)

Wave-soldering

Type	107	212	316	325	
Size	L	1.6	2.0	3.2	3.2
	W	0.8	1.25	1.6	2.5
A	0.8 to 1.0	1.0 to 1.4	1.8 to 2.5	1.8 to 2.5	
B	0.5 to 0.8	0.8 to 1.5	0.8 to 1.7	0.8 to 1.7	
C	0.6 to 0.8	0.9 to 1.2	1.2 to 1.6	1.8 to 2.5	

Reflow-soldering

Type	042	063	105	107	212	316	325	432
Size	L	0.4	0.6	1.0	1.6	2.0	3.2	4.5
	W	0.2	0.3	0.5	0.8	1.25	1.6	3.2
A	0.15 to 0.25	0.20 to 0.30	0.45 to 0.55	0.8 to 1.0	0.8 to 1.2	1.8 to 2.5	1.8 to 2.5	2.5 to 3.5
B	0.15 to 0.20	0.20 to 0.30	0.40 to 0.50	0.6 to 0.8	0.8 to 1.2	1.0 to 1.5	1.0 to 1.5	1.5 to 1.8
C	0.15 to 0.30	0.25 to 0.40	0.45 to 0.55	0.6 to 0.8	0.9 to 1.6	1.2 to 2.0	1.8 to 3.2	2.3 to 3.5

Note: Recommended land size might be different according to the allowance of the size of the product.

- LWDC: Recommended land dimensions for reflow-soldering (unit: mm)

Type	105	107	212	
Size	L	0.52	0.8	1.25
	W	1.0	1.6	2.0
A	0.18 to 0.22	0.25 to 0.3	0.5 to 0.7	
B	0.2 to 0.25	0.3 to 0.4	0.4 to 0.5	
C	0.9 to 1.1	1.5 to 1.7	1.9 to 2.1	

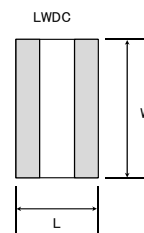
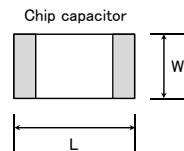
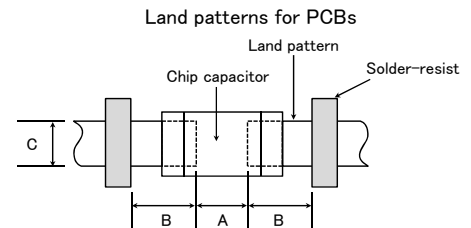

(2) Examples of good and bad solder application

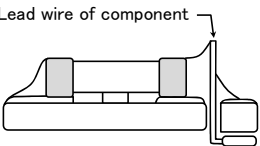
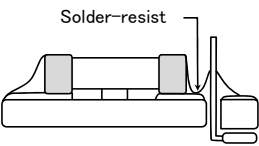
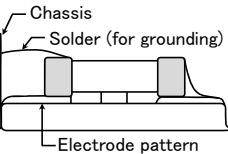
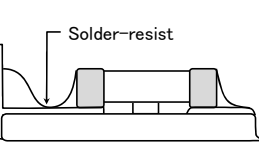
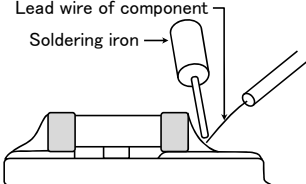
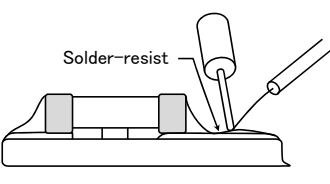
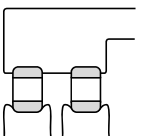
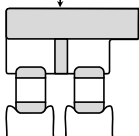
Items	Not recommended	Recommended
Mixed mounting of SMD and leaded components		
Component placement close to the chassis		
Hand-soldering of leaded components near mounted components		
Horizontal component placement		

◆ Pattern configurations (Capacitor layout on PCBs)

1-1. The following is examples of good and bad capacitor layouts ; capacitors shall be located to minimize any possible mechanical stresses from board warp or deflection.

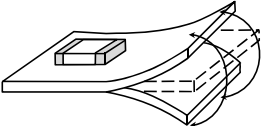
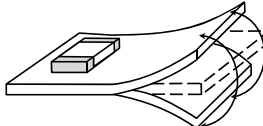
Items	Not recommended	Recommended
Deflection of board		

Place the product at a right angle to the direction of the anticipated mechanical stress.

1-2. The amount of mechanical stresses given will vary depending on capacitor layout. Please refer to diagram below.

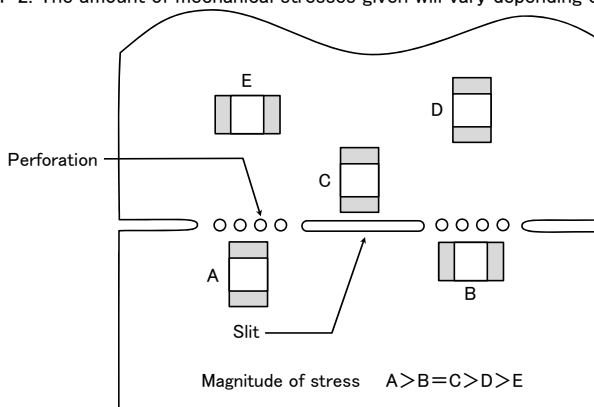

1-3. When PCB is split, the amount of mechanical stress on the capacitors can vary according to the method used. The following methods are listed in order from least stressful to most stressful: push-back, slit, V-grooving, and perforation. Thus, please consider the PCB, split methods as well as chip location.

3. Mounting

Precautions

◆ Adjustment of mounting machine

- When capacitors are mounted on PCB, excessive impact load shall not be imposed on them.
- Maintenance and inspection of mounting machines shall be conducted periodically.

◆ Selection of Adhesives

- When chips are attached on PCBs with adhesives prior to soldering, it may cause capacitor characteristics degradation unless the following factors are appropriately checked : size of land patterns, type of adhesive, amount applied, hardening temperature and hardening period. Therefore, please contact us for further information.

◆ Adjustment of mounting machine

1. When the bottom dead center of a pick-up nozzle is too low, excessive force is imposed on capacitors and causes damages. To avoid this, the following points shall be considerable.
 - (1) The bottom dead center of the pick-up nozzle shall be adjusted to the surface level of PCB without the board deflection.
 - (2) The pressure of nozzle shall be adjusted between 1 and 3 N static loads.
 - (3) To reduce the amount of deflection of the board caused by impact of the pick-up nozzle, supporting pins or back-up pins shall be used on the other side of the PCB. The following diagrams show some typical examples of good and bad pick-up nozzle placement:

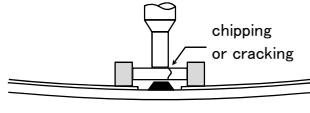
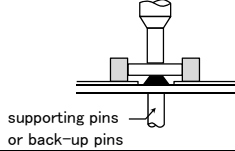
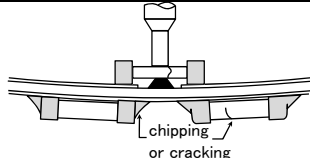
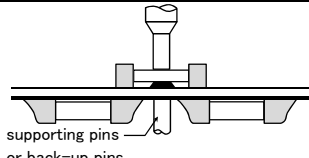
Items	Not recommended	Recommended
Single-sided mounting		
Double-sided mounting		

Technical considerations

2. As the alignment pin is worn out, adjustment of the nozzle height can cause chipping or cracking of capacitors because of mechanical impact on the capacitors. To avoid this, the monitoring of the width between the alignment pins in the stopped position, maintenance, check and replacement of the pin shall be conducted periodically.

◆ Selection of Adhesives

Some adhesives may cause IR deterioration. The different shrinkage percentage of between the adhesive and the capacitors may result in stresses on the capacitors and lead to cracking. Moreover, too little or too much adhesive applied to the board may adversely affect components. Therefore, the following precautions shall be noted in the application of adhesives.

- (1) Required adhesive characteristics
 - a. The adhesive shall be strong enough to hold parts on the board during the mounting & solder process.
 - b. The adhesive shall have sufficient strength at high temperatures.
 - c. The adhesive shall have good coating and thickness consistency.
 - d. The adhesive shall be used during its prescribed shelf life.
 - e. The adhesive shall harden rapidly.
 - f. The adhesive shall have corrosion resistance.
 - g. The adhesive shall have excellent insulation characteristics.
 - h. The adhesive shall have no emission of toxic gasses and no effect on the human body.
- (2) The recommended amount of adhesives is as follows;

[Recommended condition]

Figure	212/316 case sizes as examples
a	0.3mm min
b	100 to 120 μm
c	Adhesives shall not contact land

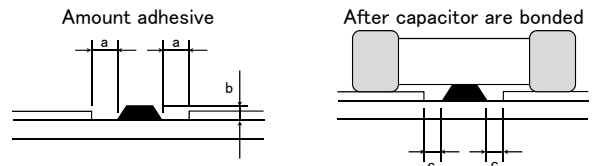

4. Soldering

◆ Selection of Flux

- Since flux may have a significant effect on the performance of capacitors, it is necessary to verify the following conditions prior to use;
- (1) Flux used shall be less than or equal to 0.1 wt% (in Cl equivalent) of halogenated content. Flux having a strong acidity content shall not be applied.
 - (2) When shall capacitors are soldered on boards, the amount of flux applied shall be controlled at the optimum level.
 - (3) When water-soluble flux is used, special care shall be taken to properly clean the boards.

Precautions

◆ Soldering

Temperature, time, amount of solder, etc. shall be set in accordance with their recommended conditions.
 Sn-Zn solder paste can adversely affect MLCC reliability.
 Please contact us prior to usage of Sn-Zn solder.

Technical considerations

◆ Selection of Flux

- 1-1. When too much halogenated substance (Chlorine, etc.) content is used to activate flux, or highly acidic flux is used, it may lead to corrosion of terminal electrodes or degradation of insulation resistance on the surfaces of the capacitors.
- 1-2. Flux is used to increase solderability in wave soldering. However if too much flux is applied, a large amount of flux gas may be emitted and may adversely affect the solderability. To minimize the amount of flux applied, it is recommended to use a flux-bubbling system.
- 1-3. Since the residue of water-soluble flux is easily dissolved in moisture in the air, the residues on the surfaces of capacitors in high humidity conditions may cause a degradation of insulation resistance and reliability of the capacitors. Therefore, the cleaning methods and the capability of the machines used shall also be considered carefully when water-soluble flux is used.

► This catalog contains the typical specification only due to the limitation of space. When you consider the purchase of our products, please check our specification. For details of each product (characteristics graph, reliability information, precautions for use, and so on), see our Web site (<http://www.ty-top.com/>).

◆Soldering

- Ceramic chip capacitors are susceptible to thermal shock when exposed to rapid or concentrated heating or rapid cooling.
- Therefore, the soldering must be conducted with great care so as to prevent malfunction of the components due to excessive thermal shock.
- Preheating : Capacitors shall be preheated sufficiently, and the temperature difference between the capacitors and solder shall be within 100 to 130°C.
- Cooling : The temperature difference between the capacitors and cleaning process shall not be greater than 100°C.

[Reflow soldering]

【Recommended conditions for eutectic soldering】

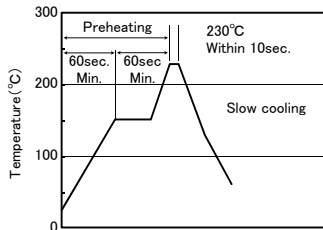

【Recommended condition for Pb-free soldering】

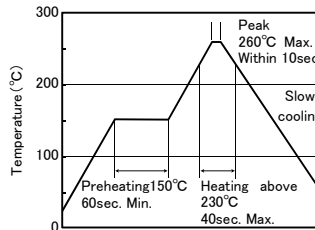

Caution

- ①The ideal condition is to have solder mass (fillet) controlled to 1/2 to 1/3 of the thickness of a capacitor.
- ②Because excessive dwell times can adversely affect solderability, soldering duration shall be kept as close to recommended times as possible.
- ③Allowable number of reflow soldering : 2 times max.

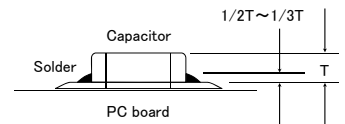

[Wave soldering]

【Recommended conditions for eutectic soldering】

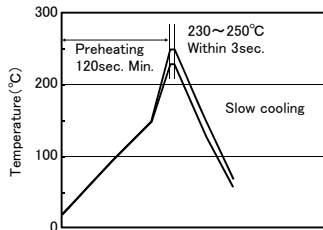

【Recommended condition for Pb-free soldering】

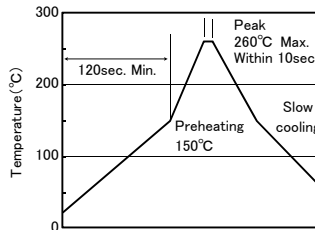

Caution

- ①Wave soldering must not be applied to capacitors designated as for reflow soldering only.
- ②Allowable number of wave soldering : 1 times max.

[Hand soldering]

【Recommended conditions for eutectic soldering】

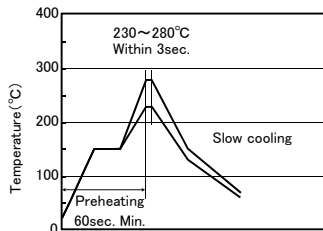

【Recommended condition for Pb-free soldering】

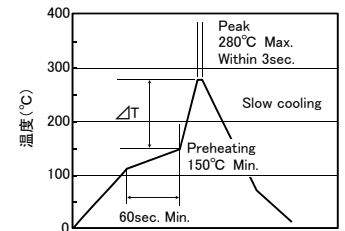
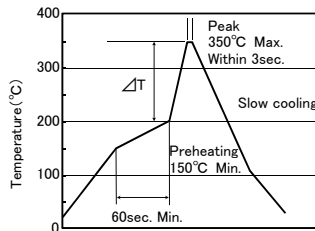

	ΔT
316type or less	$\Delta T \leq 150^{\circ}\text{C}$

	ΔT
325type or more	$\Delta T \leq 130^{\circ}\text{C}$

Caution

- ①Use a 50W soldering iron with a maximum tip diameter of 1.0 mm.
- ②The soldering iron shall not directly touch capacitors.
- ③Allowable number of hand soldering : 1 times max.

5. Cleaning	
Precautions	<p>◆Cleaning conditions</p> <ol style="list-style-type: none"> When PCBs are cleaned after capacitors mounting, please select the appropriate cleaning solution in accordance with the intended use of the cleaning. (e.g. to remove soldering flux or other materials from the production process.) Cleaning condition shall be determined after it is verified by using actual cleaning machine that the cleaning process does not affect capacitor's characteristics.
Technical considerations	<ol style="list-style-type: none"> The use of inappropriate cleaning solutions can cause foreign substances such as flux residue to adhere to capacitors or deteriorate their outer coating, resulting in a degradation of the capacitor's electrical properties (especially insulation resistance). Inappropriate cleaning conditions (insufficient or excessive cleaning) may adversely affect the performance of the capacitors. In the case of ultrasonic cleaning, too much power output can cause excessive vibration of PCBs which may lead to the cracking of capacitors or the soldered portion, or decrease the terminal electrodes' strength. Therefore, the following conditions shall be carefully checked; <ul style="list-style-type: none"> Ultrasonic output : 20 W/l or less Ultrasonic frequency : 40 kHz or less Ultrasonic washing period : 5 min. or less

6. Resin coating and mold	
Precautions	<ol style="list-style-type: none"> With some type of resins, decomposition gas or chemical reaction vapor may remain inside the resin during the hardening period or while left under normal storage conditions resulting in the deterioration of the capacitor's performance. When a resin's hardening temperature is higher than capacitor's operating temperature, the stresses generated by the excessive heat may lead to damage or destruction of capacitors. The use of such resins, molding materials etc. is not recommended.

7. Handling	
Precautions	<p>◆Splitting of PCB</p> <ol style="list-style-type: none"> When PCBs are split after components mounting, care shall be taken so as not to give any stresses of deflection or twisting to the board. Board separation shall not be done manually, but by using the appropriate devices. <p>◆Mechanical considerations</p> <p>Be careful not to subject capacitors to excessive mechanical shocks.</p> <p>(1) If ceramic capacitors are dropped onto a floor or a hard surface, they shall not be used.</p> <p>(2) Please be careful that the mounted components do not come in contact with or bump against other boards or components.</p>

8. Storage conditions	
Precautions	<p>◆Storage</p> <ol style="list-style-type: none"> To maintain the solderability of terminal electrodes and to keep packaging materials in good condition, care must be taken to control temperature and humidity in the storage area. Humidity should especially be kept as low as possible. <ul style="list-style-type: none"> Recommended conditions <ul style="list-style-type: none"> Ambient temperature : Below 30°C Humidity : Below 70% RH <p>The ambient temperature must be kept below 40°C. Even under ideal storage conditions, solderability of capacitor is deteriorated as time passes, so capacitors shall be used within 6 months from the time of delivery.</p> <ul style="list-style-type: none"> Ceramic chip capacitors shall be kept where no chlorine or sulfur exists in the air. The capacitance values of high dielectric constant capacitors will gradually decrease with the passage of time, so care shall be taken to design circuits. Even if capacitance value decreases as time passes, it will get back to the initial value by a heat treatment at 150°C for 1hour.
Technical considerations	<p>If capacitors are stored in a high temperature and humidity environment, it might rapidly cause poor solderability due to terminal oxidation and quality loss of taping/packaging materials. For this reason, capacitors shall be used within 6 months from the time of delivery. If exceeding the above period, please check solderability before using the capacitors.</p>

※RCR-2335B (Safety Application Guide for fixed ceramic capacitors for use in electronic equipment) is published by JEITA.
Please check the guide regarding precautions for deflection test, soldering by spot heat, and so on.

High Reliability Application Multilayer Ceramic Capacitors

RELIABILITY DATA

1. Operating Temperature Range	
Specified Value	X7R(−55°C to +125°C)
Test Methods and Remarks	Continuous use is available in this range. (reference temperature : 25°C)
2.Highest Operating temperature Range	
Specified Value	X7R(−55°C to +125°C)
Test Methods and Remarks	Maximum operating temperature at which capacitors can be continuously used with rated voltage applied.
3. Rated Voltage	
Specified Value	Please refer to the page of the "PART NUMBERS".
Test Methods and Remarks	Continuous maximum applied voltage. If an AC voltage is loaded on a DC voltage, the sum of the two peak voltages should be lower than the rated voltage of the capacitor.
4. Shape and Dimensions	
Specified Value	Please refer to the page of the "EXTERNAL DIMENSIONS".
5. Heat Treatment (Class II)	
Test Methods and Remarks	Initial value shall be measured after test sample is heat-treated at 150+0/−10°C for an hour and kept at room temperature for 24 ± 2 hours.
6. Voltage Treatment (Class II)	
Test Methods and Remarks	Initial value shall be measured after test sample is voltage-treated for an hour at temperature and voltage which are specified as test conditions, and kept at room temperature for 24 ± 2 hours.
7. Dielectric Withstanding Voltage (between terminals)	
Specified Value	No abnormality.
Test Methods and Remarks	Applied voltage : Rated voltage × 2.5 Duration : 1 to 5 seconds. Charging and discharging current shall be 50mA max.
8. Insulation Resistance	
Specified Value	Larger than whichever smaller of 500 MΩ · μF or 10 ⁴ MΩ
Test Methods and Remarks	Applied voltage : Rated voltage Duration : 60±5 seconds. Charging and discharging current shall be 50mA max.
9. Capacitance and Tolerance	
Specified Value	Please refer to the page of the "PART NUMBERS".
Test Methods and Remarks	Measurement frequency : 1kHz±10%(C≤10 μF) Measurement voltage : 1±0.2Vrms(C≤10 μF) 0.5±0.1V(6.3V rated voltage)
10. Q or Dissipation factor (tan δ)	
Specified Value	Please refer to the page of the "PART NUMBERS".
Test Methods and Remarks	Measurement frequency : 1kHz±10%(C≤10 μF) Measurement voltage : 1±0.2Vrms(C≤10 μF) 0.5±0.1V(6.3V rated voltage)

▶ This catalog contains the typical specification only due to the limitation of space. When you consider the purchase of our products, please check our specification. For details of each product (characteristics graph, reliability information, precautions for use, and so on), see our Web site (<http://www.ty-top.com/>).

11. Temperature Characteristic (without DC bias)													
Specified Value	X7R(-55°C to +125°C) : ±15%												
Test Methods and Remarks	Heat treatment specified in No.5 of the specification shall be conducted prior to measurement. Change of the maximum capacitance deviation in step 1 to 5.												
	<table border="1"> <thead> <tr> <th>step</th> <th>Temperature(°C)</th> </tr> </thead> <tbody> <tr> <td>1</td> <td>+25</td> </tr> <tr> <td>2</td> <td>Minimum operating temperature</td> </tr> <tr> <td>3</td> <td>+25</td> </tr> <tr> <td>4</td> <td>Maximum operating temperature</td> </tr> <tr> <td>5</td> <td>+25</td> </tr> </tbody> </table>	step	Temperature(°C)	1	+25	2	Minimum operating temperature	3	+25	4	Maximum operating temperature	5	+25
	step	Temperature(°C)											
	1	+25											
	2	Minimum operating temperature											
	3	+25											
4	Maximum operating temperature												
5	+25												

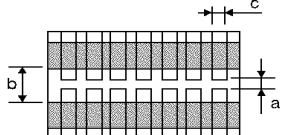
12. Adhesive Force of Terminal Electrodes																									
Specified Value	Appearance : Terminal electrodes shall be no exfoliation or a sign of exfoliation.																								
Test Methods and Remarks	<table border="1"> <thead> <tr> <th></th> <th>1608 size</th> <th>larger than 2012 size</th> </tr> </thead> <tbody> <tr> <td>Applying force</td> <td>5N</td> <td>10N</td> </tr> <tr> <td>Duration</td> <td colspan="2">30±5 seconds.</td> </tr> <tr> <td>Board</td> <td colspan="2">Glass epoxy-resin substrate</td> </tr> <tr> <td>Thickness</td> <td colspan="2">1.6mm</td> </tr> </tbody> </table>		1608 size	larger than 2012 size	Applying force	5N	10N	Duration	30±5 seconds.		Board	Glass epoxy-resin substrate		Thickness	1.6mm										
		1608 size	larger than 2012 size																						
	Applying force	5N	10N																						
	Duration	30±5 seconds.																							
	Board	Glass epoxy-resin substrate																							
	Thickness	1.6mm																							
	Solder lands refer to fig.1.																								
																									
	<table border="1"> <thead> <tr> <th rowspan="2">Dimension</th> <th colspan="4">Case size</th> </tr> <tr> <th>1608</th> <th>2012</th> <th>3216</th> <th>3225</th> </tr> </thead> <tbody> <tr> <td>a</td> <td>1.0</td> <td>1.2</td> <td>2.2</td> <td>2.2</td> </tr> <tr> <td>b</td> <td>3.0</td> <td>4.0</td> <td>5.0</td> <td>5.0</td> </tr> <tr> <td>c</td> <td>1.2</td> <td>1.65</td> <td>2.0</td> <td>2.9</td> </tr> </tbody> </table>	Dimension	Case size				1608	2012	3216	3225	a	1.0	1.2	2.2	2.2	b	3.0	4.0	5.0	5.0	c	1.2	1.65	2.0	2.9
Dimension	Case size																								
	1608	2012	3216	3225																					
a	1.0	1.2	2.2	2.2																					
b	3.0	4.0	5.0	5.0																					
c	1.2	1.65	2.0	2.9																					
	Fig.1																								

13. Vibration	
Specified Value	Appearance : No abnormality Capacitance change : Initial value shall be satisfied. Dissipation factor : Initial value shall be satisfied. Insulation resistance : Initial value shall be satisfied.
Test Methods and Remarks	Heat treatment specified in No.5 of the specification shall be conducted prior to test. Measurement shall be conducted after test sample is heat treated as specified in No.5.
	Solder lands refer to figure 1.
	Direction of the vibration test : X, Y, Z each of 3 orientations for 2 hours respectively (total 6 hours)
	Vibration frequency : 10 to 55 to 10Hz (1 minutes each)
	Total amplitude : 1.5 mm
	Measurement after the test shall be made after test sample is kept at room temperature for 24 ±2 hours.

14. Resistance to Soldering Heat	
Specified Value	Appearance : No abnormality Capacitance change : ≤ ±7.5% Dissipation factor : Initial value shall be satisfied. Insulation resistance : Initial value shall be satisfied. Dielectric withstanding voltage (between terminals) : No abnormality
Test Methods and Remarks	Heat treatment specified in No.5 of the specification shall be conducted prior to test.
	Immerse test sample in an solder solution (Sn-3Ag-0.5Cu).
	Soldering temperature : 270°C±5°C
	Duration : 3±0.5 seconds
	Soaking position : Test sample is soaked until the terminal electrode is covered in solder solution.
	Preheating condition : 3216 size or smaller size : 120 to 150°C for 1 minute, 3225 size : 100 to 120°C for 1 minute, 170 to 200°C for 1 minute.
	Measurement after the test shall be made after test sample is kept at room temperature for 24 ±2 hours.

15. Solderability	
Specified Value	More than 95% of terminal electrode shall be covered with fresh solder.
Test Methods and Remarks	Heat treatment specified in No.5 of the specification shall be conducted prior to test.
	Immerse test sample in an solder solution (Sn-3Ag-0.5Cu).
	Soldering temperature : 245°C±3°C
	Duration : 4±1 seconds
	Dipping position : Test sample is immersed until the terminal electrode is covered in solder solution.

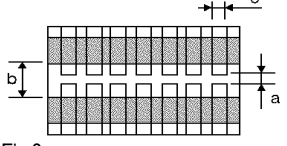
16. Thermal shock																																					
Specified Value	Appearance : No abnormality Capacitance change : $\leq \pm 7.5\%$ Dissipation factor : Initial value shall be satisfied. Insulation resistance : Initial value shall be satisfied. Dielectric withstanding voltage (between terminals) : No abnormality																																				
Test Methods and Remarks	Heat treatment specified in No.5 of the specification shall be conducted prior to test. Measurement shall be conducted after test sample is heat treated as specified in No.5. condition of the one cycle (Air—Air) <table border="1" style="margin-top: 10px;"> <thead> <tr> <th>Step</th> <th>Temperature (°C)</th> <th>Time (min.)</th> <th>Transfer time</th> </tr> </thead> <tbody> <tr> <td>1</td> <td>Minimum usage temperature</td> <td>15</td> <td>within 20 seconds</td> </tr> <tr> <td>2</td> <td>Maximum usage temperature</td> <td>15</td> <td>within 20 seconds</td> </tr> </tbody> </table> Test cycles: 100 times. Measurement after the test shall be made after test sample is kept at room temperature for 24 ± 2 hours. <div style="display: flex; align-items: center; margin-top: 10px;">  <table border="1" style="margin-left: 20px;"> <thead> <tr> <th rowspan="2">Dimension</th> <th colspan="4">Case size</th> </tr> <tr> <th>1608</th> <th>2012</th> <th>3216</th> <th>3225</th> </tr> </thead> <tbody> <tr> <td>a</td> <td>0.6</td> <td>0.8</td> <td>2.0</td> <td>2.0</td> </tr> <tr> <td>b</td> <td>2.2</td> <td>3.0</td> <td>4.4</td> <td>4.4</td> </tr> <tr> <td>c</td> <td>0.9</td> <td>1.3</td> <td>1.7</td> <td>2.6</td> </tr> </tbody> </table> </div>	Step	Temperature (°C)	Time (min.)	Transfer time	1	Minimum usage temperature	15	within 20 seconds	2	Maximum usage temperature	15	within 20 seconds	Dimension	Case size				1608	2012	3216	3225	a	0.6	0.8	2.0	2.0	b	2.2	3.0	4.4	4.4	c	0.9	1.3	1.7	2.6
Step	Temperature (°C)	Time (min.)	Transfer time																																		
1	Minimum usage temperature	15	within 20 seconds																																		
2	Maximum usage temperature	15	within 20 seconds																																		
Dimension	Case size																																				
	1608	2012	3216	3225																																	
a	0.6	0.8	2.0	2.0																																	
b	2.2	3.0	4.4	4.4																																	
c	0.9	1.3	1.7	2.6																																	

17. Humidity Loading	
Specified Value Note1	Appearance : No abnormality Capacitance change : $\leq \pm 12.5\%$ Dissipation factor : 5.0%max. Insulation resistance : Larger than whichever smaller of $25M\Omega \cdot \mu F$ or $500M\Omega$
Test Methods and Remarks	Test condition : $85^\circ C/85\%RH$. Duration : $1000 +48/-0$ hours. DC bias : Applied rated voltage. Voltage treatment specified in No.6 of the specification shall be conducted prior to test. Measurement after the test shall be made after test sample is kept at room temperature for 24 ± 2 hours.

18. High Temperature Loading	
Specified Value Note1	Appearance : No abnormality Capacitance change : $\leq \pm 12.5\%$ Dissipation factor : 5.0%max. Insulation resistance : Larger than whichever smaller of $50M\Omega \cdot \mu F$ or $1000M\Omega$
Test Methods and Remarks	Voltage treatment specified in No.6 of the specification shall be conducted prior to test. Test sample shall be put in thermostatic oven with maximum temperature. Applied voltage : Rated voltage x 2 Duration : $1000 +48/-0$ hours. Charging and discharging current shall be 50mA or less. Measurement after the test shall be made after test sample is kept at room temperature for 24 ± 2 hours.

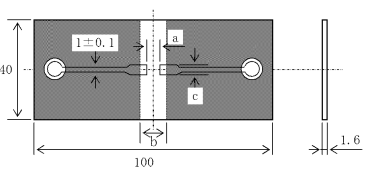
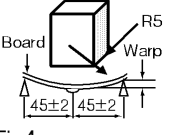
19. Resistance to Flexure of substrate																									
Specified Value	Appearance : No abnormality Capacitance change : $\leq \pm 12.5\%$ Dissipation factor : 5.0%max. Insulation resistance : Initial value shall be satisfied.																								
Test Methods and Remarks	Warp : 1mm Testing board : Grass epoxy - resin substrate Thickness : 1.6mm Test board and solder lands : Refer to fig. 3. <div style="display: flex; align-items: center; margin-top: 10px;">  <table border="1" style="margin-left: 20px;"> <thead> <tr> <th rowspan="2">Dimension</th> <th colspan="4">Case size</th> </tr> <tr> <th>1608</th> <th>2012</th> <th>3216</th> <th>3225</th> </tr> </thead> <tbody> <tr> <td>a</td> <td>0.6</td> <td>0.8</td> <td>2.0</td> <td>2.0</td> </tr> <tr> <td>b</td> <td>2.2</td> <td>3.0</td> <td>4.4</td> <td>4.4</td> </tr> <tr> <td>c</td> <td>0.9</td> <td>1.3</td> <td>1.7</td> <td>2.6</td> </tr> </tbody> </table>  </div>	Dimension	Case size				1608	2012	3216	3225	a	0.6	0.8	2.0	2.0	b	2.2	3.0	4.4	4.4	c	0.9	1.3	1.7	2.6
Dimension	Case size																								
	1608	2012	3216	3225																					
a	0.6	0.8	2.0	2.0																					
b	2.2	3.0	4.4	4.4																					
c	0.9	1.3	1.7	2.6																					

Capacitance measurement shall be conducted with the board bent. (fig.4)

▶ This catalog contains the typical specification only due to the limitation of space. When you consider the purchase of our products, please check our specification. For details of each product (characteristics graph, reliability information, precautions for use, and so on), see our Web site (<http://www.ty-top.com/>).

20. High Temperature Exposure

Specified Value Note1	Appearance	: No abnormality
	Capacitance change	: $\leq \pm 12.5\%$
	Dissipation factor	: 5.0%max.
	Insulation resistance	: Larger than whichever smaller of $500M\Omega \cdot \mu F$ or $10000M\Omega$

Test Methods and Remarks
 Heat treatment specified in No.5 of the specification shall be conducted prior to test.
 Test sample shall be put in thermostatic oven with maximum temperature.
 Duration : 1000 +48/−0 hours.
 Initial value shall be measured after test sample is heat-treated specified No.5.
 Measurement after the test shall be made after test sample is kept at room temperature for 24 ±2 hours.

21. Temperature Cycling

Specified Value Note1	Appearance	: No abnormality
	Capacitance change	: $\leq \pm 7.5\%$
	Dissipation factor	: Initial value shall be satisfied
	Insulation resistance	: Initial value shall be satisfied

Test Methods and Remarks
 Heat treatment specified in No.5 of the specification shall be conducted prior to test.
 Measurement shall be conducted after test sample is heat treated as specified in No.5.
 condition of the one cycle

Step	Temperature (°C)	Time (min.)
1	Minimum usage temperature	30 ± 3
2	+25	2 to 3
3	Maximum usage temperature	30 ± 3
4	+25	2 to 3

Test cycles: 200 times
 Solder lands refer to fig. 2.
 Measurement after the test shall be made after test sample is kept at room temperature for 24 ±2 hours.

22. Body strength

Specified Value	No mechanical damage
-----------------	----------------------

Test Methods and Remarks

Applying force : 5N
 Applying time : 10 seconds

The diagram illustrates the mechanical test setup. On the left, a 3D perspective view of a rectangular chip is shown with length L and width W, where L is greater than or equal to W. On the right, a cross-sectional view shows the chip being pressed by a hemispherical pressing jig with a radius R=0.5. The contact width between the jig and the chip is 0.6L. The entire assembly is supported by a base, and the process is labeled as 'Pressurization'.

Note 1 The figures indicate typical specifications. Please refer to individual specifications in detail.

Precautions on the use of High Reliability Application Multilayer Ceramic Capacitors

PRECAUTIONS

1. Circuit Design

- Precautions**
- ◆ Verification of operating environment, electrical rating and performance
 1. A malfunction in medical equipment, spacecraft, nuclear reactors, etc. may cause serious harm to human life or have severe social ramifications.
As such, any capacitors to be used in such equipment may require higher safety and/or reliability considerations and should be clearly differentiated from components used in general purpose applications.
 - ◆ Operating Voltage (Verification of Rated voltage)
 1. The operating voltage for capacitors must always be lower than their rated values.
If an AC voltage is loaded on a DC voltage, the sum of the two peak voltages should be lower than the rated value of the capacitor chosen. For a circuit where both an AC and a pulse voltage may be present, the sum of their peak voltages should also be lower than the capacitor's rated voltage.
 2. Even if the applied voltage is lower than the rated value, the reliability of capacitors might be reduced if either a high frequency AC voltage or a pulse voltage having rapid rise time is present in the circuit.

2. PCB Design

- Precautions**
- ◆ Pattern configurations (Design of Land-patterns)
 1. When capacitors are mounted on a PCB, the amount of solder used (size of fillet) can directly affect capacitor performance. Therefore, the following items must be carefully considered in the design of solder land patterns:
 - (1) The amount of solder applied can affect the ability of chips to withstand mechanical stresses which may lead to breaking or cracking. Therefore, when designing land-patterns it is necessary to consider the appropriate size and configuration of the solder pads which in turn determines the amount of solder necessary to form the fillets.
 - (2) When more than one part is jointly soldered onto the same land or pad, the pad must be designed so that each component's soldering point is separated by solder-resist.
 - ◆ Pattern configurations (Capacitor layout on panelized [breakaway] PC boards)
 1. After capacitors have been mounted on the boards, chips can be subjected to mechanical stresses in subsequent manufacturing processes (PCB cutting, board inspection, mounting of additional parts, assembly into the chassis, wave soldering the reflow soldered boards etc.) For this reason, planning pattern configurations and the position of SMD capacitors should be carefully performed to minimize stress.

- Technical considerations**
- ◆ Pattern configurations (Design of Land-patterns)
 1. The following diagrams and tables show some examples of recommended patterns to prevent excessive solder amounts. (larger fillets which extend above the component end terminations) Examples of improper pattern designs are also shown.

(1) Recommended land dimensions for a typical chip capacitor land patterns for PCBs
Recommended land dimensions for reflow-soldering (unit: mm)

Type		107	212	316	325
Size	L	1.6	2.0	3.2	3.2
	W	0.8	1.25	1.6	2.5
A		0.8~1.0	0.8~1.2	1.8~2.5	1.8~2.5
B		0.6~0.8	0.8~1.2	1.0~1.5	1.0~1.5
C		0.6~0.8	0.9~1.6	1.2~2.0	1.8~3.2

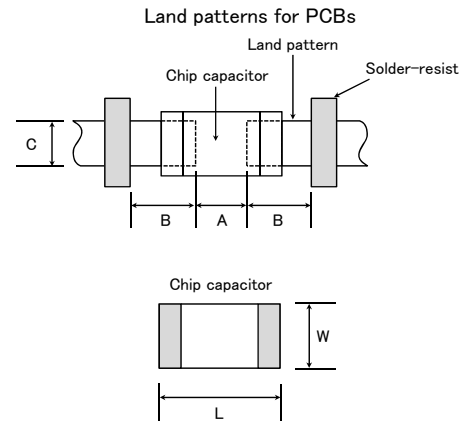

Excess solder can affect the ability of chips to withstand mechanical stresses. Therefore, please take proper precautions when designing land-patterns.

(2) Examples of good and bad solder application

Items	Not recommended	Recommended
Mixed mounting of SMD and leaded components	<p>Lead wire of component</p>	<p>Solder-resist</p>
Component placement close to the chassis	<p>Chassis Solder (for grounding) Electrode pattern</p>	<p>Solder-resist</p>
Hand-soldering of leaded components near mounted components	<p>Lead wire of component Soldering iron</p>	<p>Solder-resist</p>
Horizontal component placement		<p>Solder-resist</p>

◆ Pattern configurations (Capacitor layout on panelized [breakaway] PC boards)

1-1. The following is examples of good and bad capacitor layout; SMD capacitors should be located to minimize any possible mechanical stresses from board warp or deflection.

Items	Not recommended	Recommended
Deflection of board		<p>Place the product at a right angle to the direction of the anticipated mechanical stress.</p>

1-2. To layout the capacitors for the breakaway PC board, it should be noted that the amount of mechanical stresses given will vary depending on capacitor layout. The example below shows recommendations for better design.

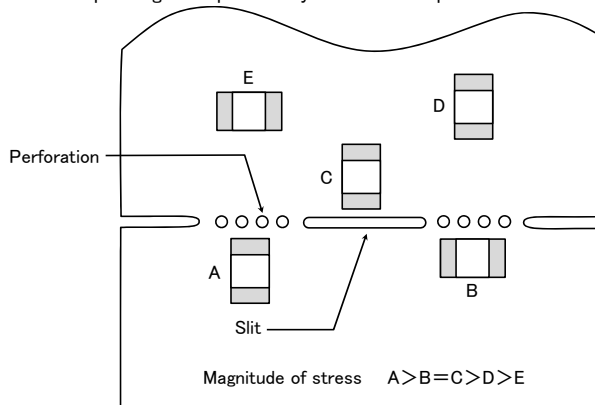

1-3. When breaking PC boards along their perforations, the amount of mechanical stress on the capacitors can vary according to the method used. The following methods are listed in order from least stressful to most stressful: push-back, slit, V-grooving, and perforation. Thus, any ideal SMD capacitor layout must also consider the PCB splitting procedure.

Precautions

◆ Selection of Flux

1. Since flux may have a significant effect on the performance of capacitors, it is necessary to verify the following conditions prior to use;
 - (1) Flux used should be with less than or equal to 0.1 wt% (equivalent to chlorine) of halogenated content. Flux having strong acidity content should not be applied.
 - (2) When soldering capacitors on the board, the amount of flux applied should be controlled at the optimum level.
 - (3) When using water-soluble flux, special care should be taken to properly clean the boards.

◆ Soldering

1. Temperature, time, amount of solder, etc. are specified in accordance with the following recommended conditions.
Sn-Zn solder paste can affect MLCC reliability performance.
Please contact us prior to usage.

Technical considerations

◆ Selection of Flux

- 1-1. When too much halogenated substance (Chlorine, etc.) content is used to activate the flux, or highly acidic flux is used, an excessive amount of residue after soldering may lead to corrosion of the terminal electrodes or degradation of insulation resistance on the surface of the capacitors.
- 1-2. Flux is used to increase solderability in flow soldering, but if too much is applied, a large amount of flux gas may be emitted and may detrimentally affect solderability. To minimize the amount of flux applied, it is recommended to use a flux-bubbling system.
- 1-3. Since the residue of water-soluble flux is easily dissolved by water content in the air, the residue on the surface of capacitors in high humidity conditions may cause a degradation of insulation resistance and therefore affect the reliability of the components. The cleaning methods and the capability of the machines used should also be considered carefully when selecting water-soluble flux.

◆ Soldering

1-1. Preheating when soldering

Heating: Ceramic chip components should be preheated to within 100 to 130°C of the soldering.

Cooling: The temperature difference between the components and cleaning process should not be greater than 100°C.

Ceramic chip capacitors are susceptible to thermal shock when exposed to rapid or concentrated heating or rapid cooling. Therefore, the soldering process must be conducted with great care so as to prevent malfunction of the components due to excessive thermal shock.

【Recommended conditions for soldering】

[Reflow soldering]

Temperature profile

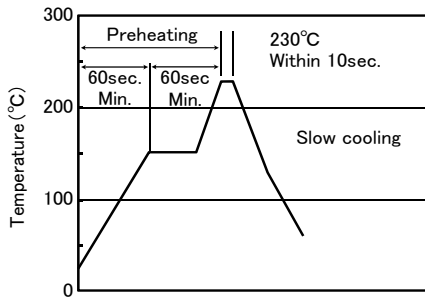

【Recommended conditions for Pd Free soldering】

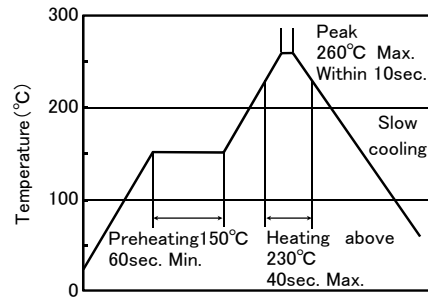

※Ceramic chip components should be preheated to within 100 to 130°C of the soldering.

※Assured to be reflow soldering for 2 times.

Caution

- ① The ideal condition is to have solder mass (fillet) controlled to 1/2 to 1/3 of the thickness of the capacitor, as shown below:

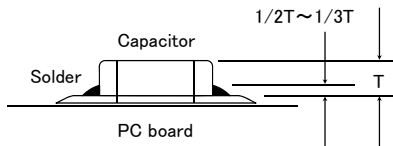

- ② Because excessive dwell times can detrimentally affect solderability, soldering duration should be kept as close to recommended times as possible.