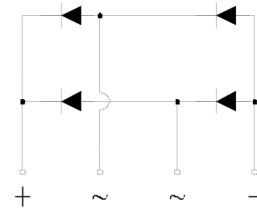
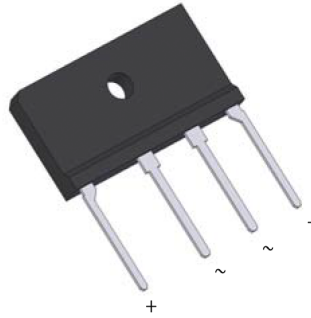

**Features**

2018

- ◆ Thin Single In-Line package;
- ◆ Ideal for printed circuit boards;
- ◆ Glass Passivated chip junction;
- ◆ Low profile package;
- ◆ High Surge current capability;
- ◆ High case dielectric strength of 2500 V<sub>RMS</sub>;
- ◆ Plastic package has Underwrites Laboratory Flammability Classification 94V-0;
- ◆ Same footprint V.S GBJ package;

**RoHS  
COMPLIANT**
**Mechanical Data**

- ◆ Case: GBJL;  
Epoxy meets UL-94V-0 Flammability rating;
- ◆ Terminals: Matte tin plated leads, solderable per J-STD-002 and JESD22-B102;  
E3 suffix for customer grade, meet JESD 201;
- ◆ High temperature soldering guaranteed:  
Solder Dip 270°C, 10seconds;
- ◆ Polarity: As marked on body;
- ◆ Mounting Torque: 10cm·kg (8.8inches·lbs) max;
- ◆ Recommend Torque: Mounting Torque:  
5.7cm·kg (5inches·lbs);

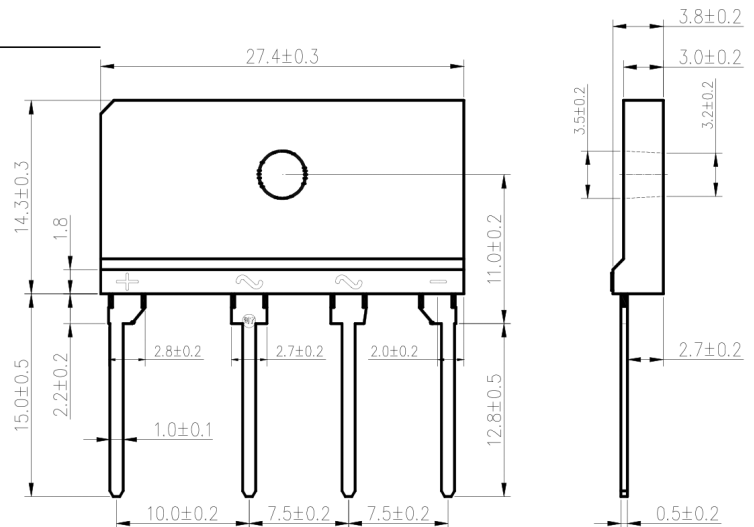

Package Dimensions in mm

**Typical Applications**

General purpose use in AC-to-DC bridge full wave rectification for Switching Power Supply, Home Appliances, Office Equipment, Industrial Automation applications.

**Maximum Ratings and Electrical Characteristics**

Ratings at 25°C ambient temperature unless otherwise specified.

Parameter	Symbol	GBJL6J	GBJL6K	GBJL6M	Unit
Maximum repetitive peak reverse voltage	V <sub>RRM</sub>	600	800	1000	V
Maximum RMS voltage	V <sub>RMS</sub>	420	560	700	V
Maximum DC blocking voltage	V <sub>DC</sub>	600	800	1000	V
Maximum average forward rectified output current at T <sub>C</sub> =110°C T <sub>A</sub> =25°C	I <sub>F(AV)</sub>	6 <sup>(1)</sup> 2.5 <sup>(2)</sup>			Amps
Peak forward surge current 8.3 ms single sine-wave superimposed on rated load (JEDEC Method)	I <sub>FSM</sub>	120			Amps
Rating for fusing (t<8.3ms)	I <sup>2</sup> t	60			A <sup>2</sup> sec
Maximum Instantaneous forward voltage drop per leg at 3.0A	V <sub>F</sub>	0.98			Volt
Maximum DC Reverse Current at Rated DC Blocking Voltage per leg T <sub>A</sub> =25°C T <sub>A</sub> =125°C	I <sub>R</sub>	5 150			μA
Typical thermal resistance per leg	R <sub>θJA</sub> R <sub>θJC</sub>	22 <sup>(2)</sup> 2.5 <sup>(1)</sup>			°C/W
Operating junction and Storage Temperature Range	T <sub>J</sub> , T <sub>STG</sub>	-55 to +150			°C

**Notes:**

- 1). Unit case mounted on Al plate heatsink;
- 2). Units mounted on PCB without heatsink;
- 3). Recommended mounting position is to bolt down on heatsink with silicone thermal compound for maximum heat transfer with #6 screw.

**RATINGS AND CHARACTERISTICS CURVES**

( $T_A=25^\circ\text{C}$  unless otherwise noted)

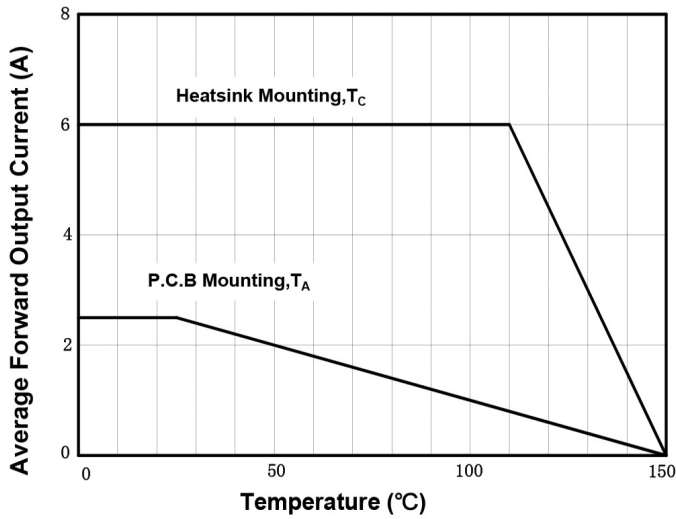

**Figure 1. Derating Curve Output Rectified Current**

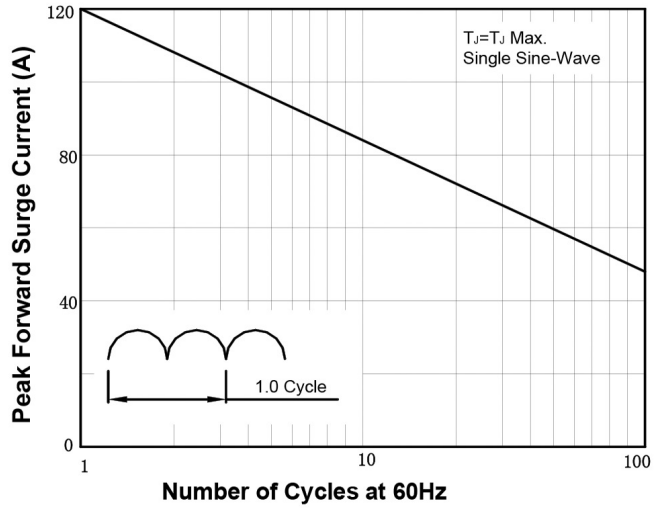

**Figure 2. Maximum Non-Repetitive Peak Forward Surge Current per Diode**

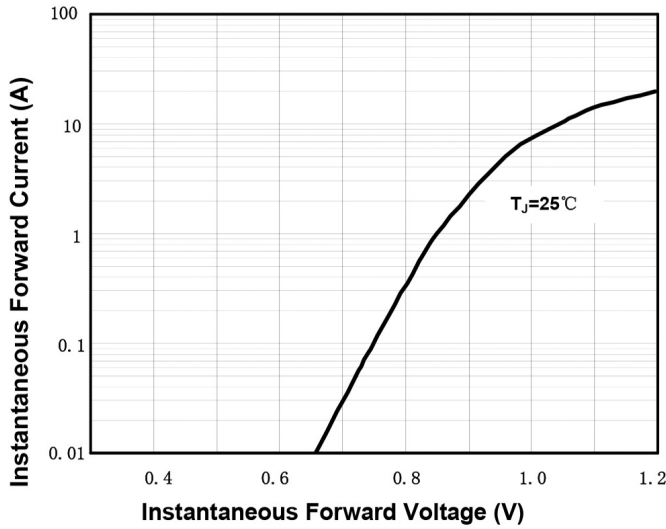

**Figure 3. Typical Forward Characteristics Per Diode**

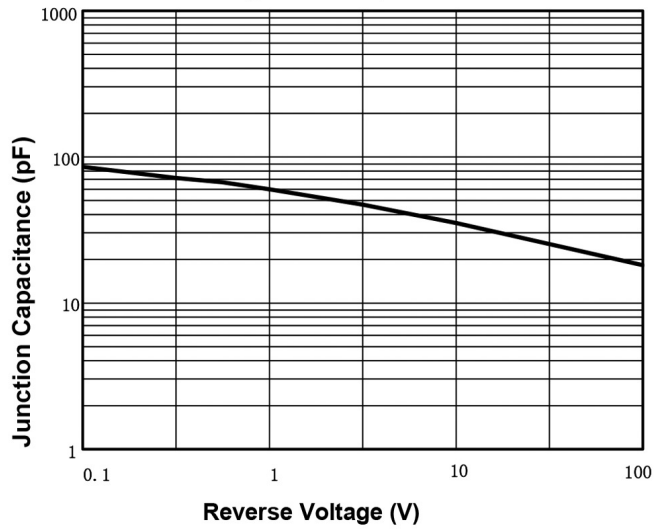

**Figure 4. Typical Junction Capacitance Per Diode**

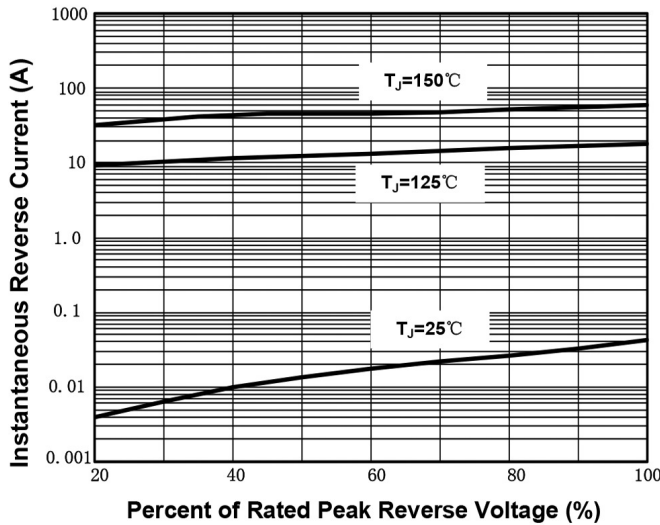

**Figure 5. Typical Reverse Characteristics Per Diode**