

LOW VOLTAGE OPERATION 3-WIRE SERIAL E²PROM

The S-93L76A is a low voltage operating, high speed, low current consumption, 3-wire serial E²PROM with a wide operating voltage range. The S-93L76A has the capacity of 8 K-bit, and the organization is 512-word × 16 bit. It is capable of sequential read, at which time addresses are automatically incremented in 16-bit blocks.

The communication method is by the Microwire bus.

■ Features

- Operating voltage range:

Read	1.6 V to 5.5 V
Write	1.8 V to 5.5 V (WRITE, ERASE)
	2.7 V to 5.5 V (WRAL, ERAL)
- Operating frequency: 2.0 MHz (V_{CC} = 4.5 V to 5.5 V)
- Write time: 10.0 ms max.
- Sequential read capable
- Write protect function during the low power supply voltage
- Endurance: 10⁶ cycles / word*¹ (T_a = +85°C)
- Data retention:

100 years	(T _a = +25°C)
20 years	(T _a = +85°C)
- Memory capacity: 8 K-bit
- Initial delivery state: FFFFh
- Operation temperature range: T_a = -40°C to +85°C
- Lead-free, Sn 100%, halogen-free*²

*1. For each address (Word: 16-bit)

*2. Refer to “**■ Product Name Structure**” for details.

■ Packages

- 8-Pin SOP (JEDEC)
- 8-Pin TSSOP
- TMSOP-8

Caution This product is intended to use in general electronic devices such as consumer electronics, office equipment, and communications devices. Before using the product in medical equipment or automobile equipment including car audio, keyless entry and engine control unit, contact to SII Semiconductor Corporation is indispensable.

■ Pin Configurations

1. 8-Pin SOP (JEDEC)

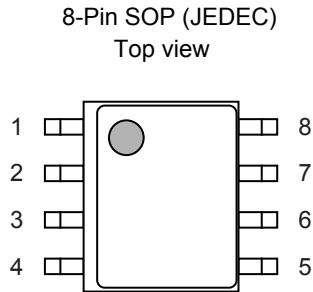

Figure 1

S-93L76AD0I-J8T1x

Table 1

Pin No.	Symbol	Description
1	CS	Chip select input
2	SK	Serial clock input
3	DI	Serial data input
4	DO	Serial data output
5	GND	Ground
6	TEST*1	Test
7	NC	No connection
8	VCC	Power supply

*1. Connect to GND or V_{CC}.

Even if this pin is not connected, performance is not affected so long as the absolute maximum rating is not exceeded.

2. 8-Pin TSSOP

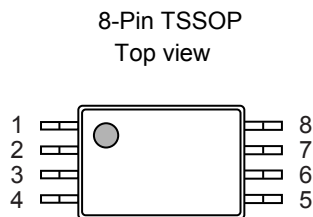

Figure 2

S-93L76AD0I-T8T1x

Table 2

Pin No.	Symbol	Description
1	CS	Chip select input
2	SK	Serial clock input
3	DI	Serial data input
4	DO	Serial data output
5	GND	Ground
6	TEST*1	Test
7	NC	No connection
8	VCC	Power supply

*1. Connect to GND or V_{CC}.

Even if this pin is not connected, performance is not affected so long as the absolute maximum rating is not exceeded.

Remark 1. Refer to the “Package drawings” for the details.

2. x: G or U

3. Please select products of environmental code = U for Sn 100%, halogen-free products.

3. TMSOP-8

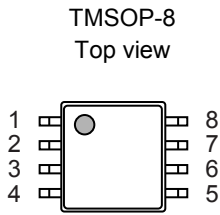

Figure 3

S-93L76AD0I-K8T3U

Table 3

Pin No.	Symbol	Description
1	CS	Chip select input
2	SK	Serial clock input
3	DI	Serial data input
4	DO	Serial data output
5	GND	Ground
6	TEST*1	Test
7	NC	No connection
8	VCC	Power supply

*1. Connect to GND or V_{CC}.

Even if this pin is not connected, performance is not affected so long as the absolute maximum rating is not exceeded.

Remark Refer to the "Package drawings" for the details.

■ Block Diagram

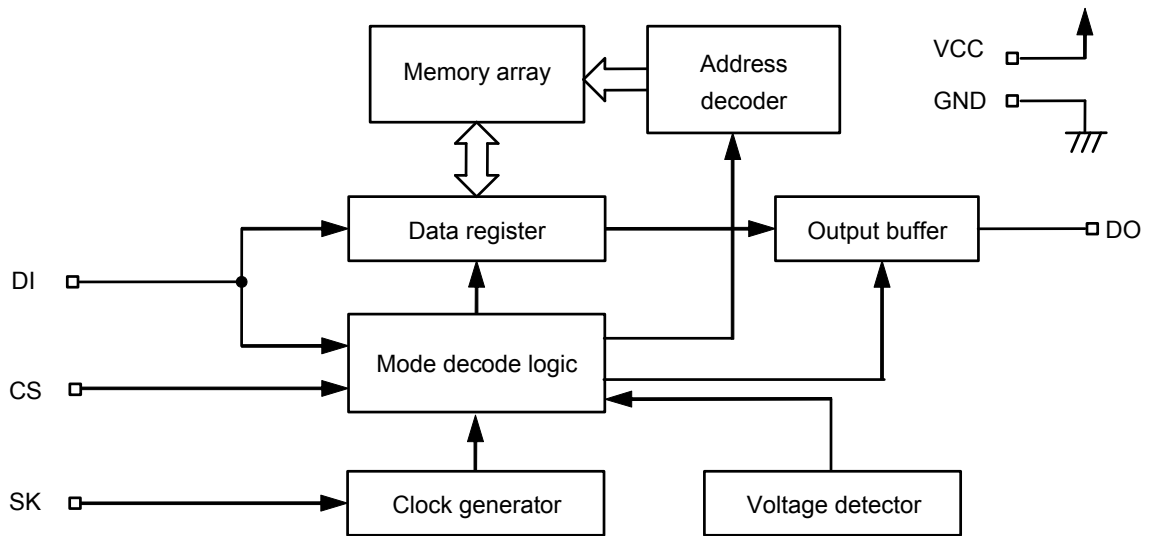

Figure 4

■ **Instruction Set**

Table 4

Instruction SK input clock	Start Bit	Operation Code		Address										Data
	1	2	3	4	5	6	7	8	9	10	11	12	13	14 to 29
READ (Read data)	1	1	0	x	A8	A7	A6	A5	A4	A3	A2	A1	A0	D15 to D0 Output*1
WRITE (Write data)	1	0	1	x	A8	A7	A6	A5	A4	A3	A2	A1	A0	D15 to D0 Input
ERASE (Erase data)	1	1	1	x	A8	A7	A6	A5	A4	A3	A2	A1	A0	—
WRAL (Write all)	1	0	0	0	1	x	x	x	x	x	x	x	x	D15 to D0 Input
ERAL (Erase all)	1	0	0	1	0	x	x	x	x	x	x	x	x	—
EWEN (Write enable)	1	0	0	1	1	x	x	x	x	x	x	x	x	—
EWDS (Write disable)	1	0	0	0	0	x	x	x	x	x	x	x	x	—

*1. When the 16-bit data in the specified address has been output, the data in the next address is output.

Remark x: Don't care

■ **Absolute Maximum Ratings**

Table 5

Item	Symbol	Ratings	Unit
Power supply voltage	V _{CC}	-0.3 to +7.0	V
Input voltage	V _{IN}	-0.3 to V _{CC} + 0.3	V
Output voltage	V _{OUT}	-0.3 to V _{CC}	V
Operation ambient temperature	T _{opr}	-40 to +85	°C
Storage temperature	T _{stg}	-65 to +150	°C

Caution The absolute maximum ratings are rated values exceeding which the product could suffer physical damage. These values must therefore not be exceeded under any conditions.

■ **Recommended Operating Conditions**

Table 6

Item	Symbol	Conditions	Ta = -40°C to +85°C		Unit
			Min.	Max.	
Power supply voltage	V _{CC}	READ, EWDS	1.6	5.5	V
		WRITE, ERASE, EWEN	1.8	5.5	V
		WRAL, ERAL	2.7	5.5	V
High level input voltage	V _{IH}	V _{CC} = 4.5 V to 5.5 V	2.0	V _{CC}	V
		V _{CC} = 2.7 V to 4.5 V	0.8 × V _{CC}	V _{CC}	V
		V _{CC} = 1.6 V to 2.7 V	0.8 × V _{CC}	V _{CC}	V
Low level input voltage	V _{IL}	V _{CC} = 4.5 V to 5.5 V	0.0	0.8	V
		V _{CC} = 2.7 V to 4.5 V	0.0	0.2 × V _{CC}	V
		V _{CC} = 1.6 V to 2.7 V	0.0	0.15 × V _{CC}	V

■ **Pin Capacitance**

Table 7

(Ta = +25°C, f = 1.0 MHz, V_{CC} = 5.0 V)

Item	Symbol	Conditions	Min.	Max.	Unit
Input capacitance	C _{IN}	V _{IN} = 0 V	—	8	pF
Output capacitance	C _{OUT}	V _{OUT} = 0 V	—	10	pF

■ **Endurance**

Table 8

Item	Symbol	Operation Ambient Temperature	Min.	Max.	Unit
Endurance	N _w	Ta = -40°C to +85°C	10 ⁶	—	cycles / word*1

*1. For each address (Word: 16-bit)

■ **Data Retention**

Table 9

Item	Symbol	Operation Ambient Temperature	Min.	Max.	Unit
Data retention	—	Ta = +25°C	100	—	year
		Ta = -40°C to +85°C	20	—	year

■ **DC Electrical Characteristics**

Table 10

Item	Symbol	Conditions	Ta = -40°C to +85°C						Unit
			V _{CC} = 4.5 V to 5.5 V		V _{CC} = 2.5 V to 4.5 V		V _{CC} = 1.6 V to 2.5 V		
			Min.	Max.	Min.	Max.	Min.	Max.	
Current consumption (READ)	I _{CC1}	DO no load	—	0.8	—	0.5	—	0.4	mA

Table 11

Item	Symbol	Conditions	Ta = -40°C to +85°C				Unit
			V _{CC} = 4.5 V to 5.5 V		V _{CC} = 1.8 V to 4.5 V		
			Min.	Max.	Min.	Max.	
Current consumption (WRITE)	I _{CC2}	DO no load	—	2.0	—	1.5	mA

Table 12

Item	Symbol	Conditions	Ta = -40°C to +85°C						Unit
			V _{CC} = 4.5 V to 5.5 V		V _{CC} = 2.5 V to 4.5 V		V _{CC} = 1.6 V to 2.5 V		
			Min.	Max.	Min.	Max.	Min.	Max.	
Standby current consumption	I _{SB}	CS = GND, DO = Open, Other inputs to V _{CC} or GND	—	2.0	—	2.0	—	2.0	μA
Input leakage current	I _{LI}	V _{IN} = GND to V _{CC}	—	1.0	—	1.0	—	1.0	μA
Output leakage current	I _{LO}	V _{OUT} = GND to V _{CC}	—	1.0	—	1.0	—	1.0	μA
Low level output voltage	V _{OL}	I _{OL} = 2.1 mA	—	0.4	—	—	—	—	V
		I _{OL} = 100 μA	—	0.1	—	0.1	—	0.1	V
High level output voltage	V _{OH}	I _{OH} = -400 μA	2.4	—	—	—	—	—	V
		I _{OH} = -100 μA	V _{CC} - 0.3	—	V _{CC} - 0.3	—	—	—	V
		I _{OH} = -10 μA	V _{CC} - 0.2	—	V _{CC} - 0.2	—	V _{CC} - 0.2	—	V
Data hold voltage of write enable latch	V _{DH}	Only program disable mode	1.5	—	1.5	—	1.5	—	V

■ AC Electrical Characteristics

Table 13 Measurement Conditions

Input pulse voltage	$0.1 \times V_{CC}$ to $0.9 \times V_{CC}$
Output reference voltage	$0.5 \times V_{CC}$
Output load	100 pF

Table 14

Item	Symbol	Ta = -40°C to +85°C						Unit
		V _{CC} = 4.5 V to 5.5 V		V _{CC} = 2.5 V to 4.5 V		V _{CC} = 1.6 V to 2.5 V		
		Min.	Max.	Min.	Max.	Min.	Max.	
CS setup time	t _{CSS}	0.2	—	0.4	—	1.0	—	μs
CS hold time	t _{CSh}	0	—	0	—	0	—	μs
CS deselect time	t _{CDS}	0.2	—	0.2	—	0.4	—	μs
Data setup time	t _{DS}	0.1	—	0.2	—	0.4	—	μs
Data hold time	t _{DH}	0.1	—	0.2	—	0.4	—	μs
Output delay time	t _{PD}	—	0.4	—	0.8	—	2.0	μs
Clock frequency	f _{SK}	0	2.0	0	1.0	0	0.25	MHz
SK clock time "L" *1	t _{SKL}	0.1	—	0.25	—	1.0	—	μs
SK clock time "H" *1	t _{SKH}	0.1	—	0.25	—	1.0	—	μs
Output disable time	t _{HZ1} , t _{HZ2}	0	0.15	0	0.5	0	1.0	μs
Output enable time	t _{SV}	0	0.15	0	0.5	0	1.0	μs

*1. The clock cycle of the SK clock (frequency: f_{SK}) is 1 / f_{SK} μs. This clock cycle is determined by a combination of several AC characteristics, so be aware that even if the SK clock cycle time is minimized, the clock cycle (1 / f_{SK}) cannot be made equal to t_{SKL} (min.) + t_{SKH} (min.).

Table 15

Item	Symbol	Ta = -40°C to +85°C			Unit
		V _{CC} = 1.8 V to 5.5 V			
		Min.	Typ.	Max.	
Write time	t _{PR}	—	4.0	10.0	ms

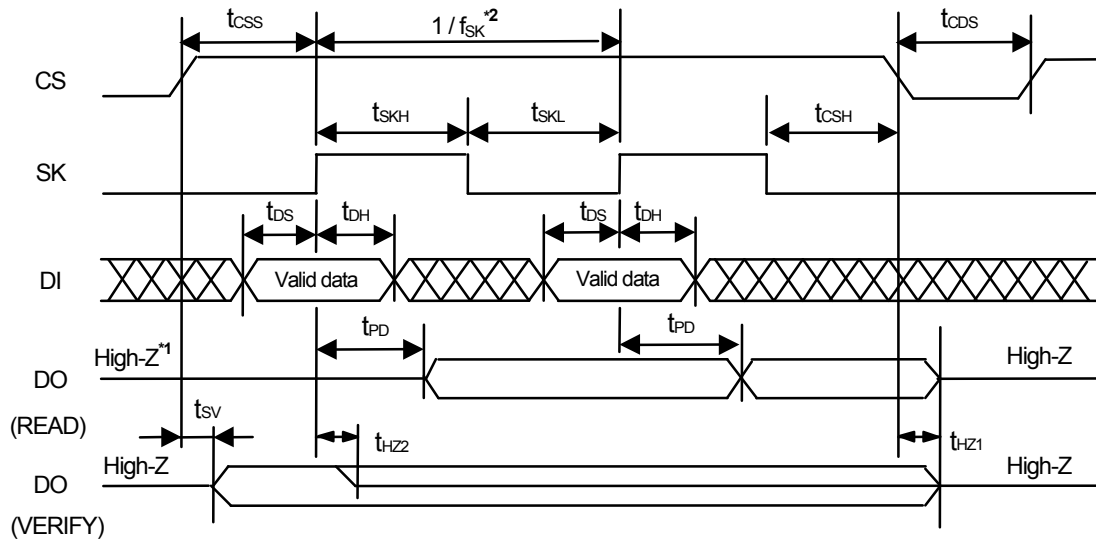

*1. Indicates high impedance.

*2. $1 / f_{SK}$ is the SK clock cycle. This clock cycle is determined by a combination of several AC characteristics, so be aware that even if the SK clock cycle time is minimized, the clock cycle ($1 / f_{SK}$) cannot be made equal to $t_{SKL} (\text{min.}) + t_{SKH} (\text{min.})$.

Figure 5 Timing Chart

■ Initial Delivery State

Initial delivery state of all addresses is “FFFFh”.

■ Operation

All instructions are executed by making CS “H” and then inputting DI at the rising edge of the SK pulse. An instruction is input in the order of its start bit, instruction, address, and data. The start bit is recognized when “H” of DI is input at the rising edge of SK after CS has been made “H”. As long as DI remains “L”, therefore, the start bit is not recognized even if the SK pulse is input after CS has been made “H”. The SK clock input while DI is “L” before the start bit is input is called a dummy clock. By inserting as many dummy clocks as required before the start bit, the number of clocks the internal serial interface of the CPU can send out and the number of clocks necessary for operation of the serial memory IC can be adjusted. Inputting the instruction is complete when CS is made “L”. CS must be made “L” once during the period of t_{CDS} in between instructions.

“L” of CS indicates a standby status. In this status, input of SK and DI is invalid, and no instruction is accepted.

1. Reading (READ)

The READ instruction is used to read the data at a specified address. When this instruction is executed, the address A_0 is input at the rising edge of SK and the DO pin, which has been in a high-impedance (High-Z) state, outputs “L”. Subsequently, 16 bits of data are sequentially output at the rising edge of SK.

If SK is output after the 16-bit data of the specified address has been output, the address is automatically incremented, and the 16-bit data of the next address is then output. By inputting SK sequentially with CS kept at “H”, the data of the entire memory space can be read. When the address is incremented from the last address ($A_8 \dots A_1 A_0 = 1 \dots 1 1$), it returns to the first address ($A_8 \dots A_1 A_0 = 0 \dots 0 0$).

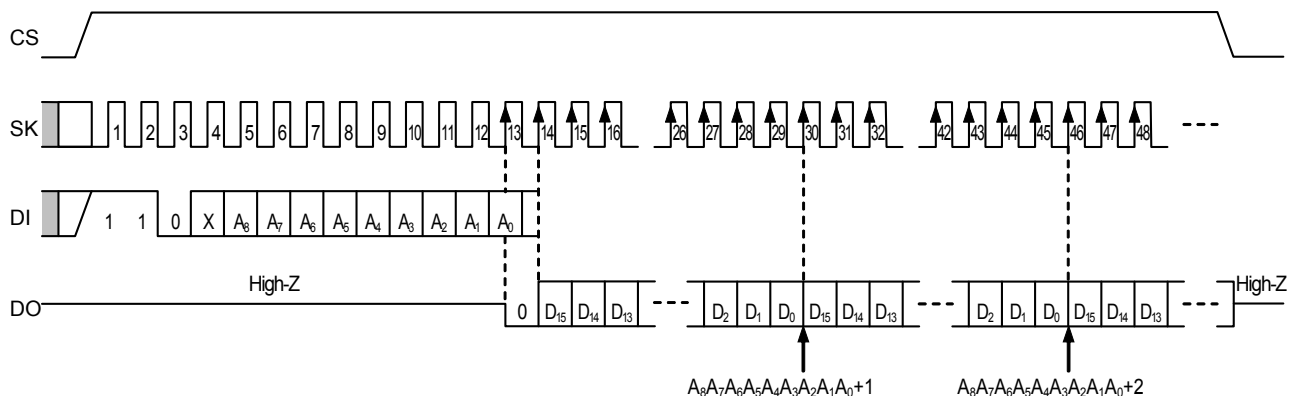

Figure 6 Read Timing

2. Writing (WRITE, ERASE, WRAL, ERAL)

Write instructions (WRITE, ERASE, WRAL, and ERAL) are used to start writing data to the non-volatile memory by making CS “L” after the specified number of clocks has been input.

The write operation is completed within the write time t_{PR} (10 ms) no matter which write instruction is used. The typical write time is less than half 10 ms. If the end of the write operation is known, therefore, the write cycle can be minimized. To ascertain the end of a write operation, make CS “L” to start the write operation and then make CS “H” again to check the status of the DO output pin. This series of operations is called a verify operation.

If DO outputs “L” during the verify operation period in which CS is “H”, it indicates that a write operation is in progress. If DO outputs “H”, it indicates that the write operation is finished. The verify operation can be executed as many times as required. This operation can be executed in two ways. One is detecting the positive transition of DO output from “L” to “H” while holding CS at “H”. The other is detecting the positive transition of DO output from “L” to “H” by making CS “H” once and checking DO output, and then returning CS to “L”.

During the write period, SK and DI are invalid. Do not input any instructions during this period. Input an instruction while the DO pin is outputting “H” or is in a high-impedance state. Even while the DO pin is outputting “H”, DO immediately goes into a high-impedance (High-Z) state if “H” of DI (start bit) is input at the rising edge of SK.

Keep DI “L” during the verify operation period.

2.1 Writing data (WRITE)

This instruction is used to write 16-bit data to a specified address.

After making CS “H”, input a start bit, the WRITE instruction, an address, and 16-bit data. If data of more than 16 bits is input, the written data is sequentially shifted at each clock, and the 16 bits input last are the valid data. The write operation is started when CS is made “L”. It is not necessary to set data to “1” before it is written.

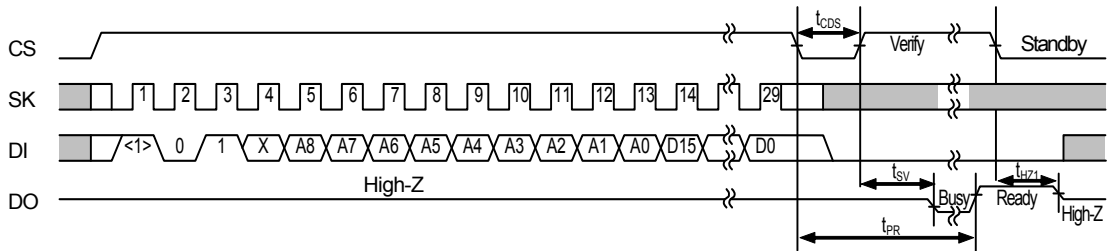

Figure 7 Data Write Timing

2.2 Erasing data (ERASE)

This instruction is used to erase specified 16-bit data. All the 16 bits of the data are “1”. After making CS “H”, input a start bit, the ERASE instruction, and an address. It is not necessary to input data. The data erase operation is started when CS is made “L”.

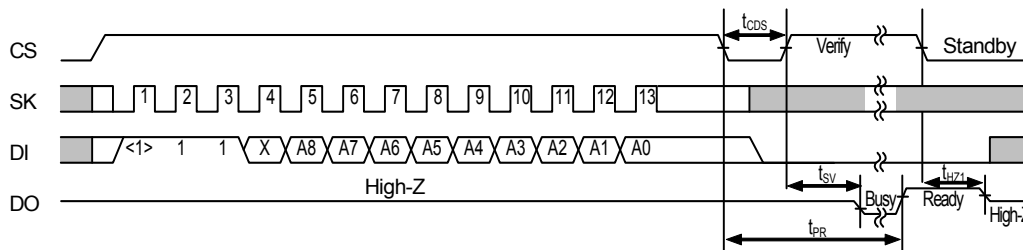

Figure 8 Data Erase Timing

2.3 Writing to chip (WRAL)

This instruction is used to write the same 16-bit data to the entire address space of the memory. After making CS “H”, input a start bit, the WRAL instruction, an address, and 16-bit data. Any address may be input. If data of more than 16 bits is input, the written data is sequentially shifted at each clock, and the 16-bit data input last is the valid data. The write operation is started when CS is made “L”. It is not necessary to set the data to “1” before it is written.

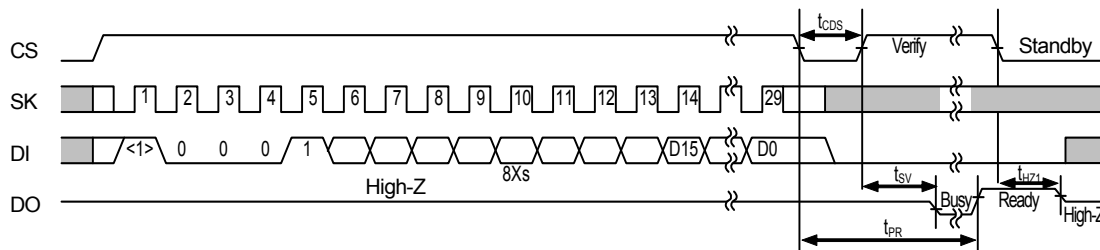

Figure 9 Chip Write Timing

2.4 Erasing chip (ERAL)

This instruction is used to erase the data of the entire address space of the memory. All the data is “1”. After making CS “H”, input a start bit, the ERAL instruction, and an address. Any address may be input. It is not necessary to input data. The chip erase operation is started when CS is made “L”.

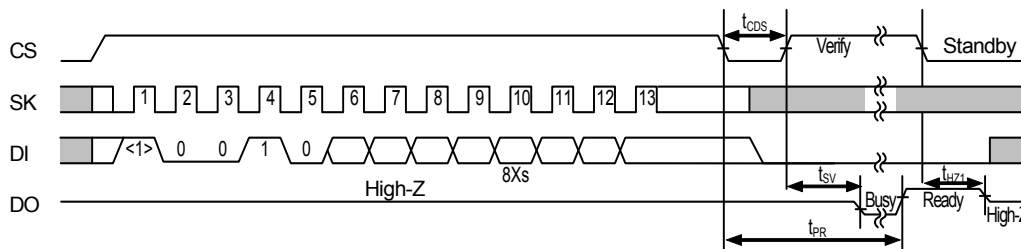

Figure 10 Chip Erase Timing

3. Write enable (EWEN) and write disable (EWDS)

The EWEN instruction is used to enable a write operation. The status in which a write operation is enabled is called the program-enabled mode.

The EWDS instruction is used to disable a write operation. The status in which a write operation is disabled is called the program-disabled mode.

The write operation is disabled upon power application and detection of a low supply voltage. To prevent an unexpected write operation due to external noise or a CPU malfunctions, it should be kept in write disable mode except when performing write operations, after power-on and before shutdown.

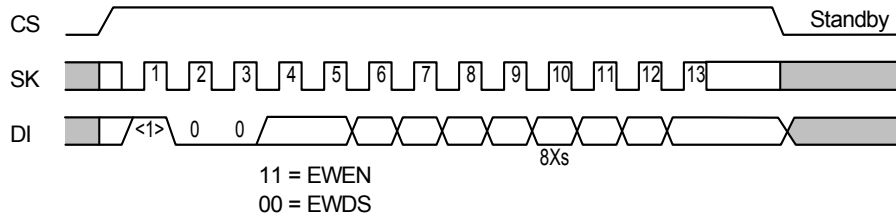

Figure 11 Write Enable / Disable Timing

■ Start Bit

A start bit is recognized by latching the high level of DI at the rising edge of SK after changing CS to high (start bit recognition). A write operation begins by inputting the write instruction and setting CS to low. Subsequently, by setting CS to high again, the DO pin outputs a low level if the write operation is still in progress and a high level if the write operation is complete (verify operation). Therefore, only after a write operation, in order to input the next command, CS is set to high, which switches the DO pin from a high-impedance state (High-Z) to a data output state. However, if start bit is recognized, the DO pin returns to the high-impedance state (refer to **Figure 5 Timing Chart**).

Make sure that data output from the CPU does not interfere with the data output from the serial memory IC when configuring a 3-wire interface by connecting the DI input pin and DO output pin, as such interference may cause a start bit fetch problem. Take the measures described in **“■ 3-Wire Interface (Direct Connection between DI and DO)”**.

■ Write Protect Function during the Low Power Supply Voltage

The S-93L76A provides a built-in detection circuit to detect a low power supply voltage. When the power supply voltage is low or at power-on, the write instructions (WRITE, ERASE, WRAL, and ERAL) are cancelled, and the write disable state (EWDS) is automatically set. The detection voltage and the release voltage are 1.4 V typ. (refer to **Figure 12**).

Therefore, when a write operation is performed after the power supply voltage has dropped and then risen again up to the level at which writing is possible, a write enable instruction (EWEN) must be sent before a write instruction (WRITE, ERASE, WRAL, or ERAL) is executed.

When the power supply voltage drops during a write operation, the data being written to an address at that time is not guaranteed.

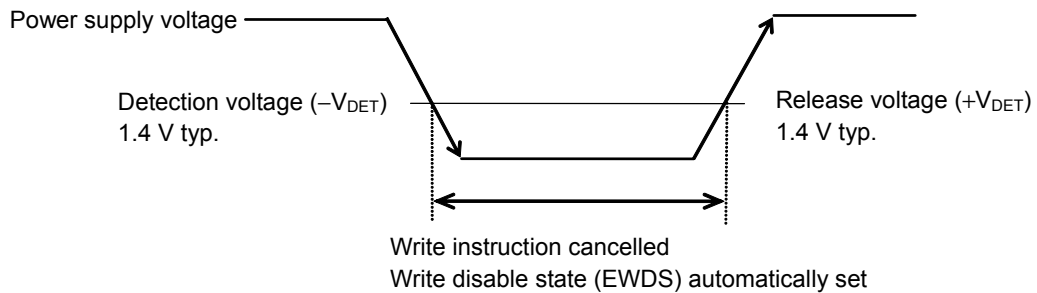

Figure 12 Operation during Low Power Supply Voltage

■ 3-Wire Interface (Direct Connection between DI and DO)

There are two types of serial interface configurations: a 4-wire interface configured using the CS, SK, DI, and DO pins, and a 3-wire interface that connects the DI input pin and DO output pin.

When the 3-wire interface is employed, a period in which the data output from the CPU and the data output from the serial memory collide may occur, causing a malfunction. To prevent such a malfunction, connect the DI and DO pins of the S-93L76A via a resistor (10 kΩ to 100 kΩ) so that the data output from the CPU takes precedence in being input to the DI pin (refer to **Figure 13**).

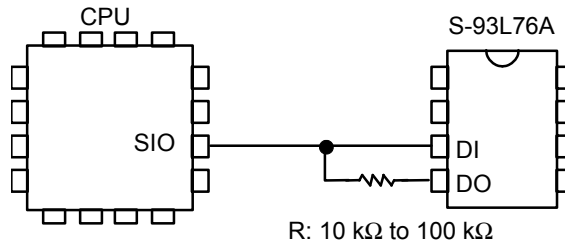

Figure 13 Connection of 3-Wire Interface

■ Input Pin and Output Pin

1. Connection of input pins

All the input pins of the S-93L76A have the CMOS structure. Do not set these pins in high impedance during operation when you design. Especially, set the CS pin to “L” at power-on, power-off, and during standby. The error write does not occur as long as the CS pin is “L”. Set the CS pin to GND via a resistor (the pull-down resistor of 10 kΩ to 100 kΩ).

To prevent the error for sure, it is recommended to use equivalent pull-down resistors for input pins other than the CS pin.

2. Equivalent circuit of input pin and output pin

The following shows the equivalent circuits of input pins of the S-93L76A. None of the input pins incorporate pull-up and pull-down elements, so special care must be taken when designing to prevent a floating status.

Output pins are high-level / low-level / high-impedance tri-state outputs.

The TEST pin is disconnected from the internal circuit by a switching transistor during normal operation. As long as the absolute maximum rating is satisfied, the TEST pin and internal circuit will never be connected.

2.1 Input pin

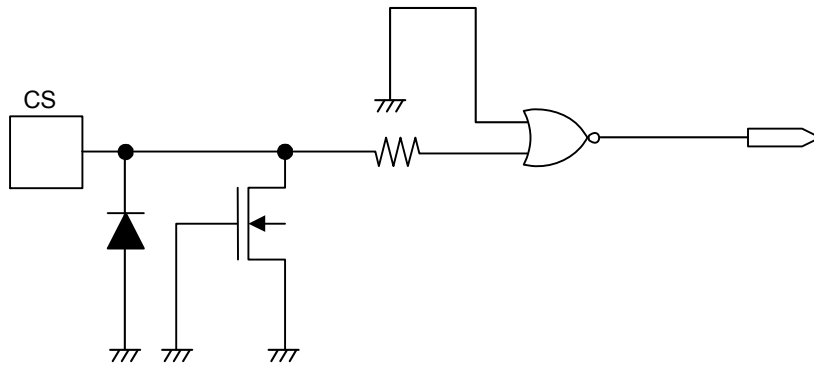

Figure 14 CS Pin

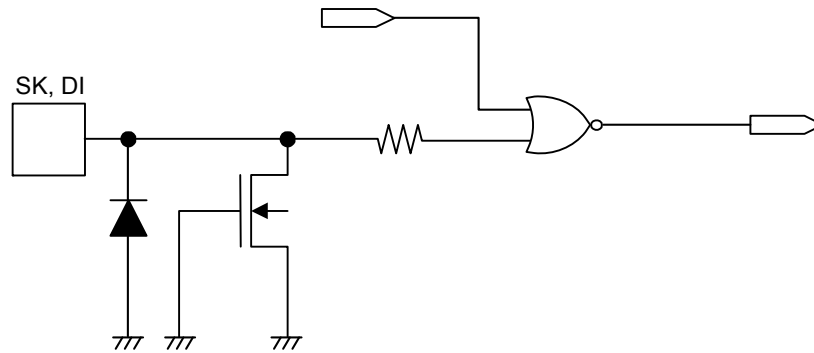

Figure 15 SK, DI Pin

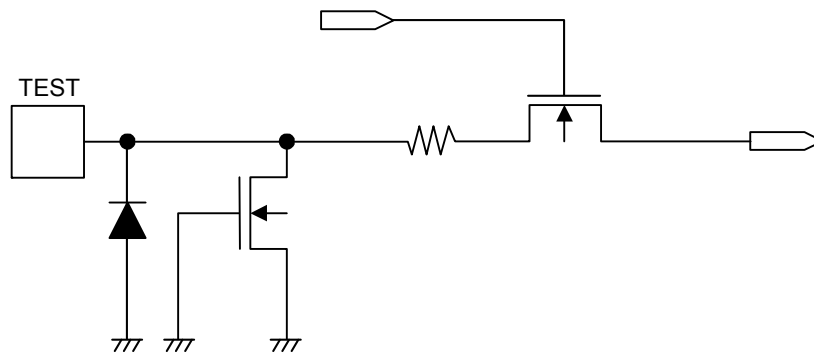

Figure 16 TEST Pin

2.2 Output pin

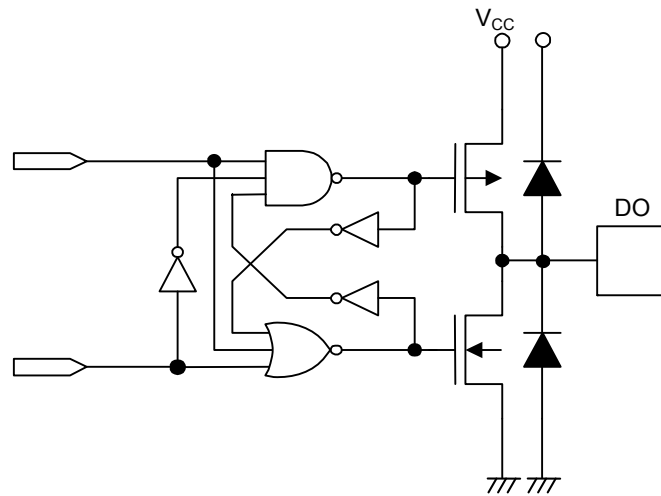

Figure 17 DO Pin

3. Input pin noise elimination time

The S-93L76A has a built-in low-pass filter at the SK pin, the DI pin and the CS pin to suppress noise. If the supply voltage is 5.0 V, noise with a pulse width of 20 ns or less at room temperature can be suppressed by the low-pass filter.

Note that noise with a pulse width of more than 20 ns is recognized as a pulse since the noise can not be suppressed if the voltage exceeds V_{IH} / V_{IL} .

■ Precaution

- Do not apply an electrostatic discharge to this IC that exceeds the performance ratings of the built-in electrostatic protection circuit.
- SII Semiconductor Corporation claims no responsibility for any and all disputes arising out of or in connection with any infringement of the products including this IC upon patents owned by a third party.

■ Characteristics (Typical Data)

1. DC Characteristics

1.1 Current consumption (READ) I_{CC1} vs. ambient temperature T_a

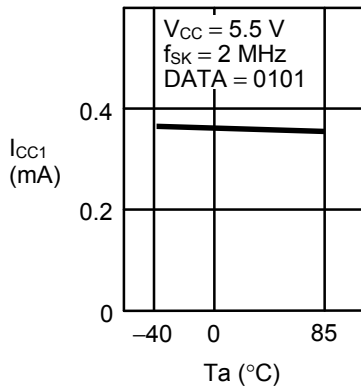

1.2 Current consumption (READ) I_{CC1} vs. ambient temperature T_a

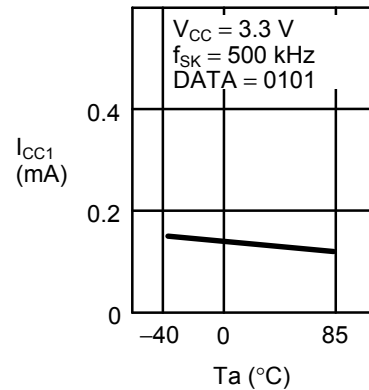

1.3 Current consumption (READ) I_{CC1} vs. ambient temperature T_a

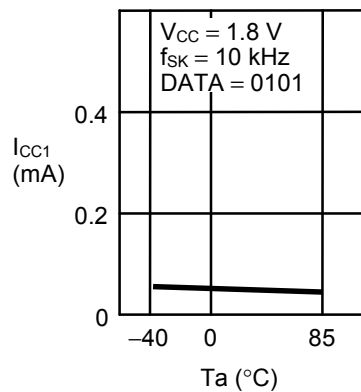

1.4 Current consumption (READ) I_{CC1} vs. power supply voltage V_{CC}

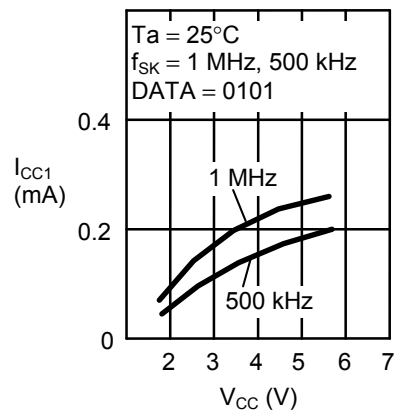

1.5 Current consumption (READ) I_{CC1} vs. power supply voltage V_{CC}

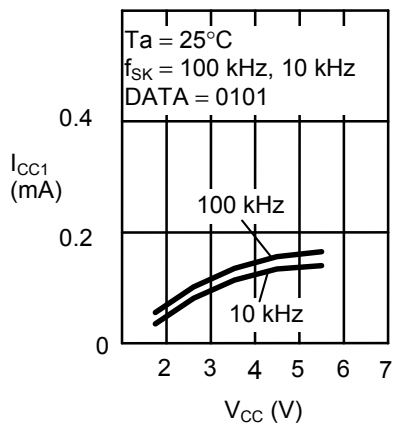

1.6 Current consumption (READ) I_{CC1} vs. Clock frequency f_{SK}

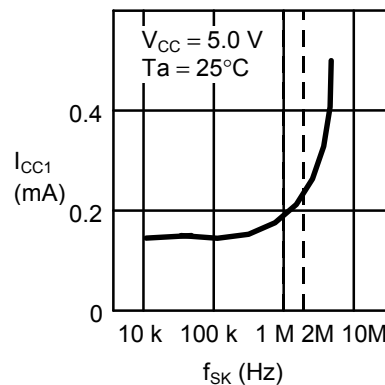

1.7 Current consumption (WRITE) I_{CC2} vs. ambient temperature T_a

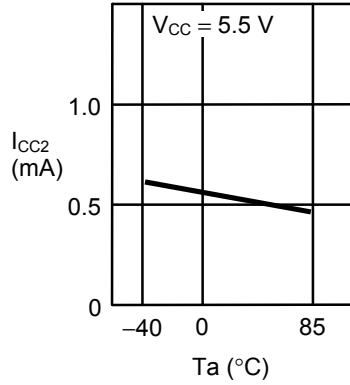

1.8 Current consumption (WRITE) I_{CC2} vs. ambient temperature T_a

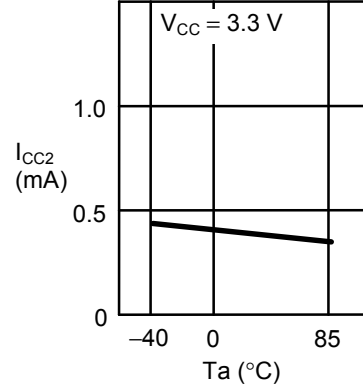

1.9 Current consumption (WRITE) I_{CC2} vs. ambient temperature T_a

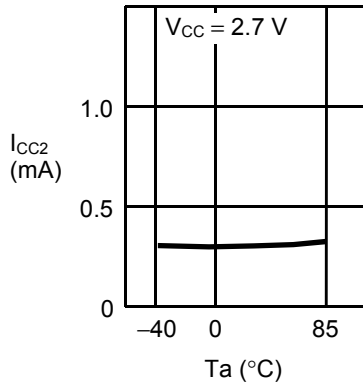

1.10 Current consumption (WRITE) I_{CC2} vs. power supply voltage V_{CC}

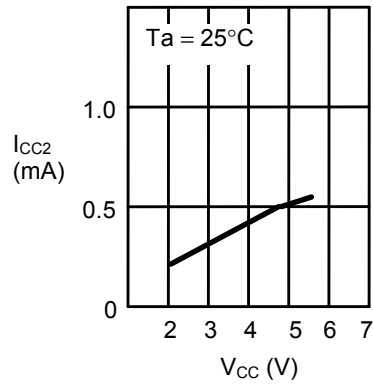

1.11 Current consumption in standby mode I_{SB} vs. ambient temperature T_a

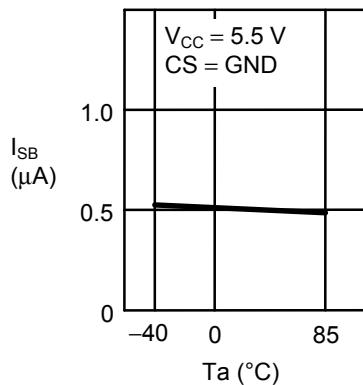

1.12 Current consumption in standby mode I_{SB} vs. power supply voltage V_{CC}

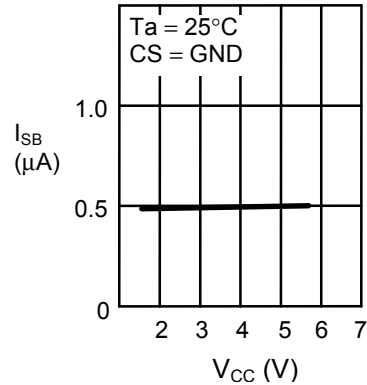

**1. 13 Input leakage current I_{LI}
vs. ambient temperature T_a**

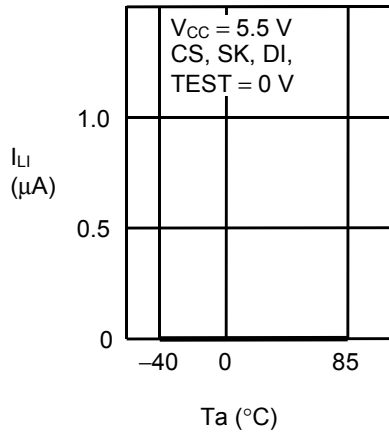

**1. 14 Input leakage current I_{LI}
vs. ambient temperature T_a**

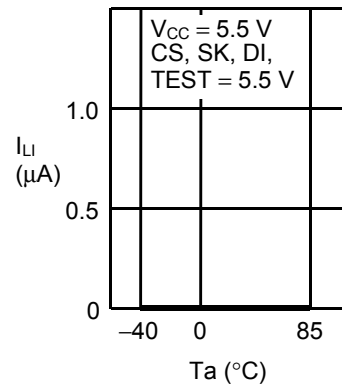

**1. 15 Output leakage current I_{LO}
vs. ambient temperature T_a**

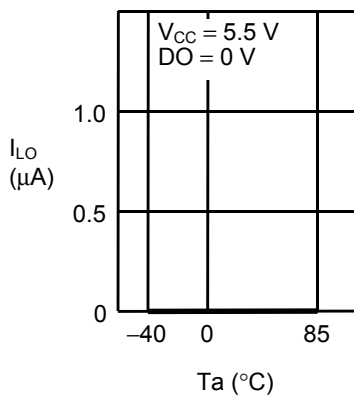

**1. 16 Output leakage current I_{LO}
vs. ambient temperature T_a**

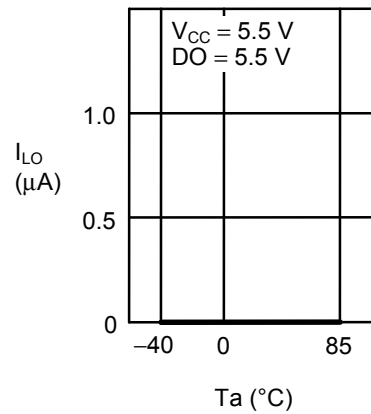

**1. 17 High-level output voltage V_{OH}
vs. ambient temperature T_a**

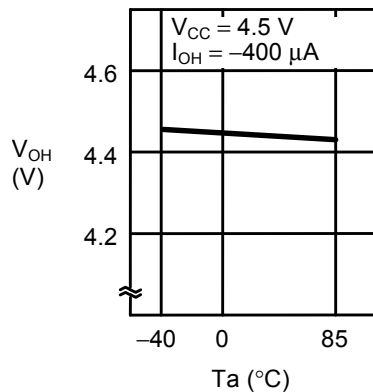

**1. 18 High-level output voltage V_{OH}
vs. ambient temperature T_a**

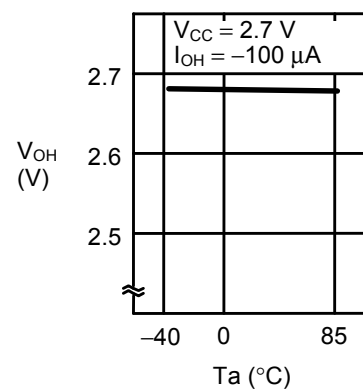

1. 19 High-level output voltage V_{OH}
vs. ambient temperature T_a

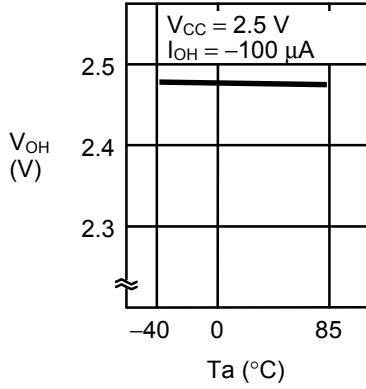

1. 20 High-level output voltage V_{OH}
vs. ambient temperature T_a

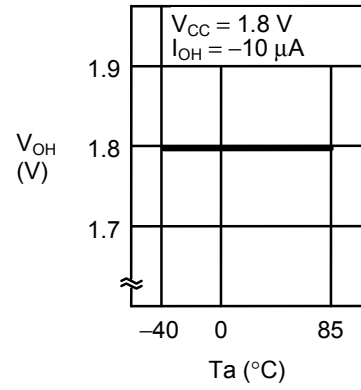

1. 21 Low-level output voltage V_{OL}
vs. ambient temperature T_a

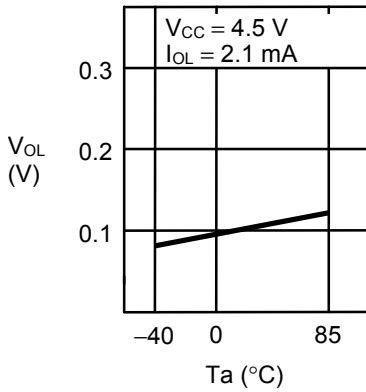

1. 22 Low-level output voltage V_{OL}
vs. ambient temperature T_a

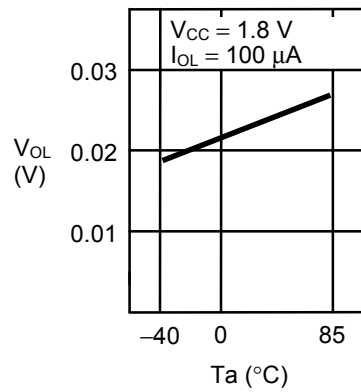

1. 23 High-level output current I_{OH}
vs. ambient temperature T_a

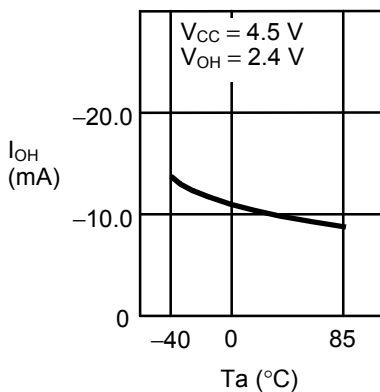

1. 24 High-level output current I_{OH}
vs. ambient temperature T_a

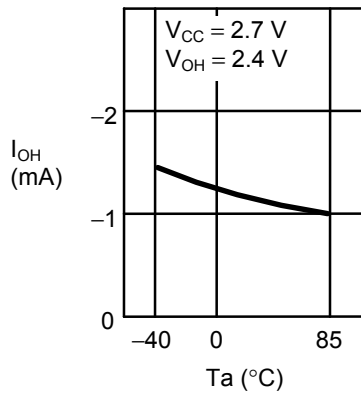

**1. 25 High-level output current I_{OH}
vs. ambient temperature T_a**

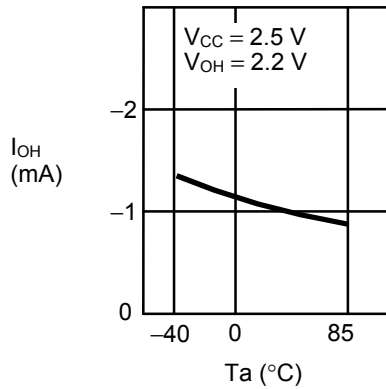

**1. 26 High-level output current I_{OH}
vs. ambient temperature T_a**

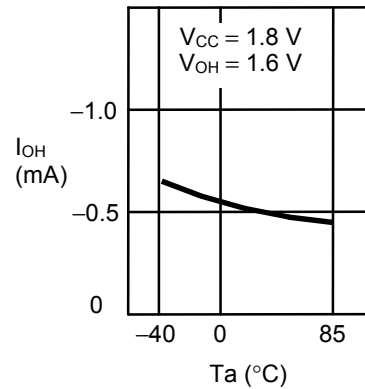

**1. 27 Low-level output current I_{OL}
vs. ambient temperature T_a**

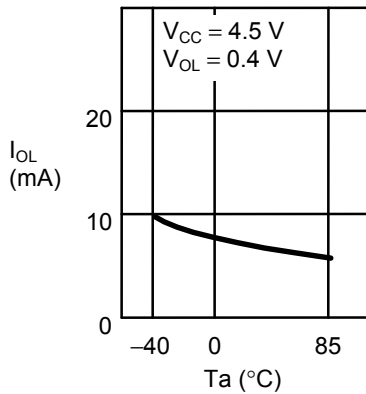

**1. 28 Low-level output current I_{OL}
vs. ambient temperature T_a**

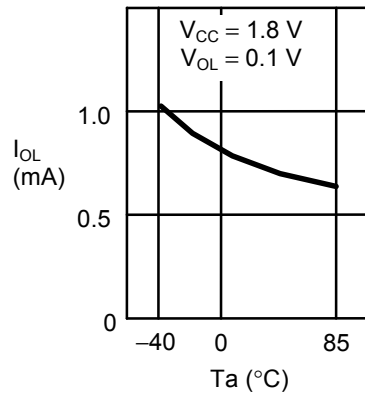

**1. 29 Input inverted voltage V_{INV}
vs. power supply voltage V_{CC}**

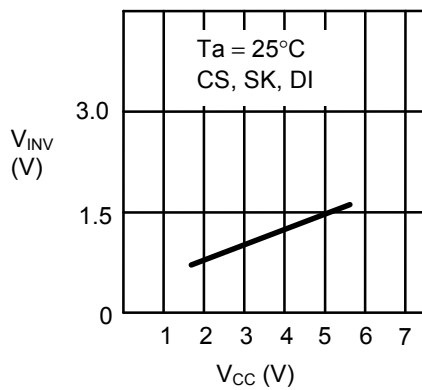

**1. 30 Input inverted voltage V_{INV}
vs. ambient temperature T_a**

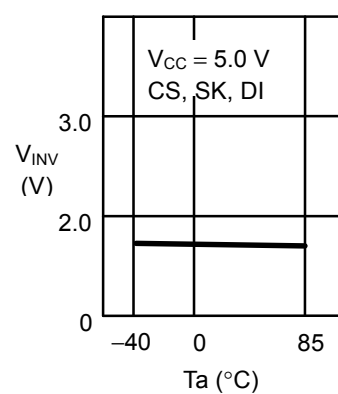

1. 31 Low supply voltage detection voltage $-V_{DET}$
vs. ambient temperature T_a

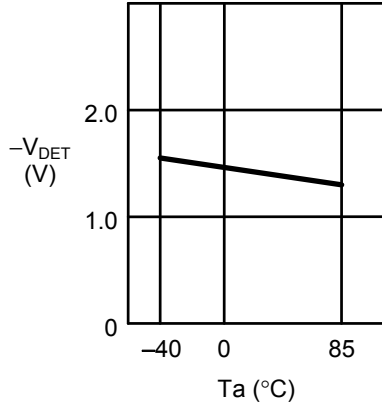

1. 32 Low supply voltage release voltage $+V_{DET}$
vs. ambient temperature T_a

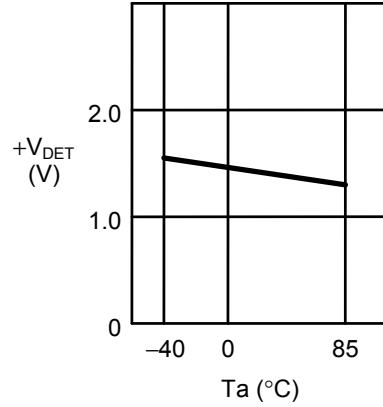

2. AC Characteristics

2. 1 Maximum operating frequency $f_{MAX.}$
vs. power supply voltage V_{CC}

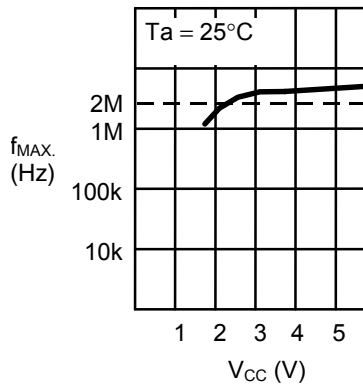

2. 2 Write time t_{PR}
vs. power supply voltage V_{CC}

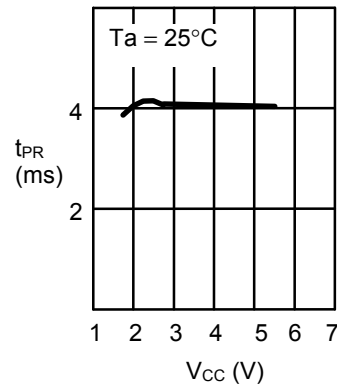

2. 3 Write time t_{PR}
vs. ambient temperature T_a

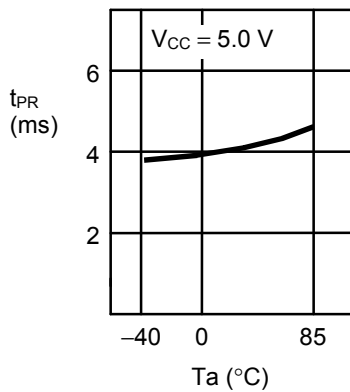

2. 4 Write time t_{PR}
vs. ambient temperature T_a

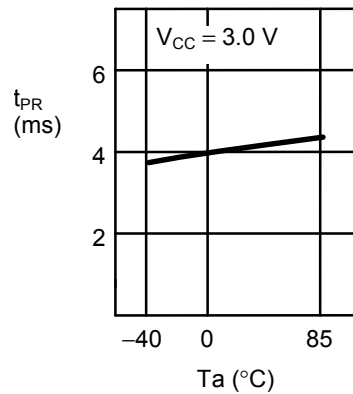

**2.5 Write time t_{PR}
vs. ambient temperature T_a**

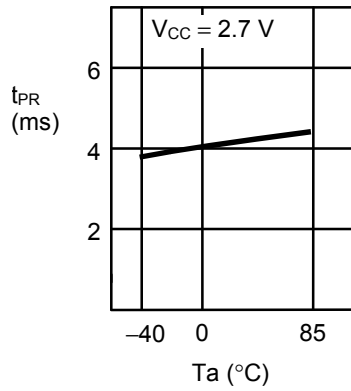

**2.6 Data output delay time t_{PD}
vs. ambient temperature T_a**

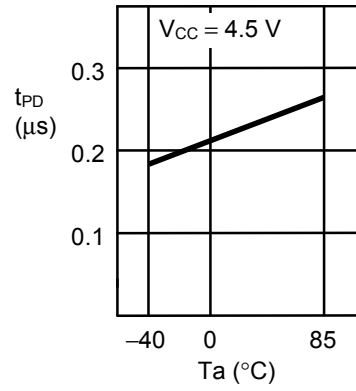

**2.7 Data output delay time t_{PD}
vs. ambient temperature T_a**

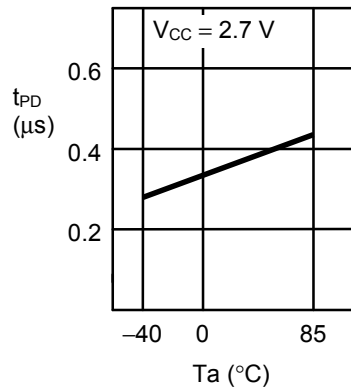

**2.8 Data output delay time t_{PD}
vs. ambient temperature T_a**

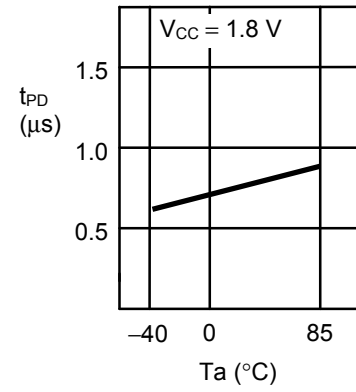

■ **Product Name Structure**

1. Product name

1.1 8-Pin SOP (JEDEC), 8-Pin TSSOP

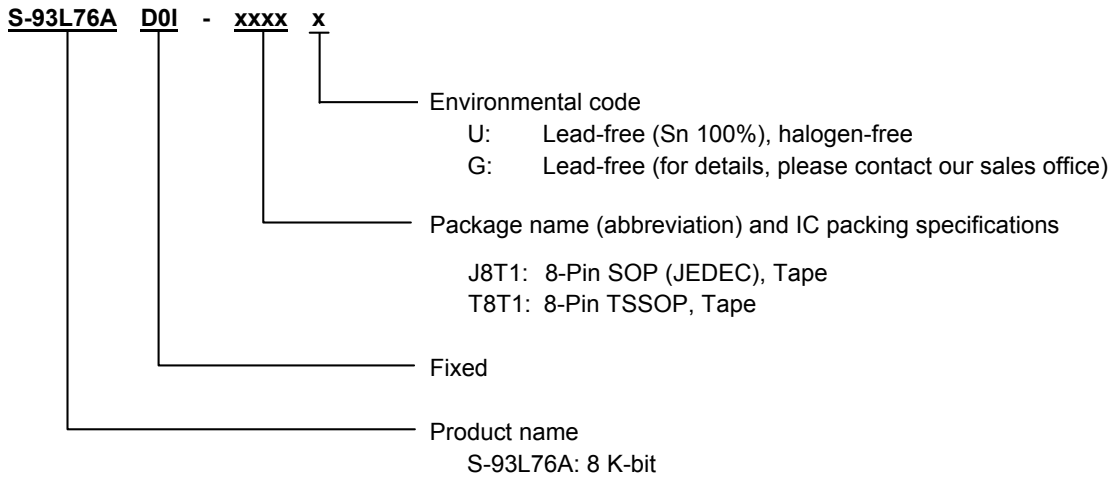

1.2 TMSOP-8

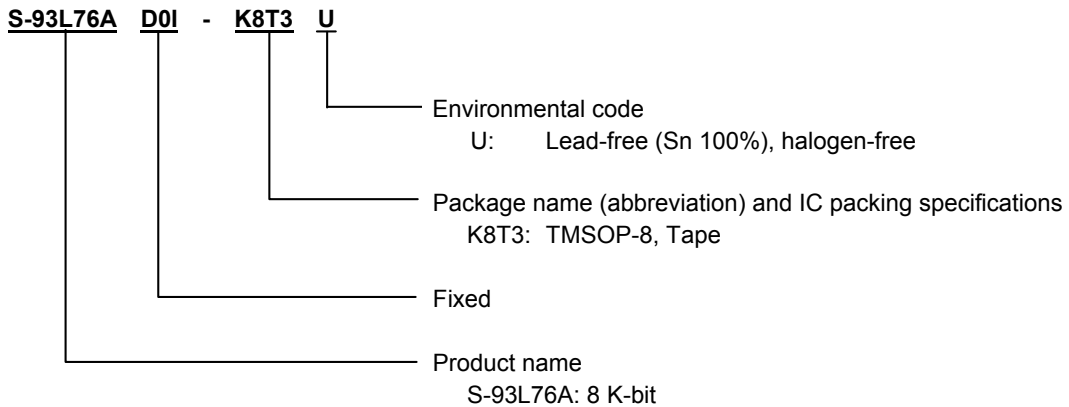

2. Packages

Package Name		Drawing Code		
		Package	Tape	Reel
8-Pin SOP (JEDEC)	Environmental code = G	FJ008-A-P-SD	FJ008-D-C-SD	FJ008-D-R-SD
	Environmental code = U	FJ008-A-P-SD	FJ008-D-C-SD	FJ008-D-R-S1
8-Pin TSSOP	Environmental code = G	FT008-A-P-SD	FT008-E-C-SD	FT008-E-R-SD
	Environmental code = U	FT008-A-P-SD	FT008-E-C-SD	FT008-E-R-S1
TMSOP-8		FM008-A-P-SD	FM008-A-C-SD	FM008-A-R-SD

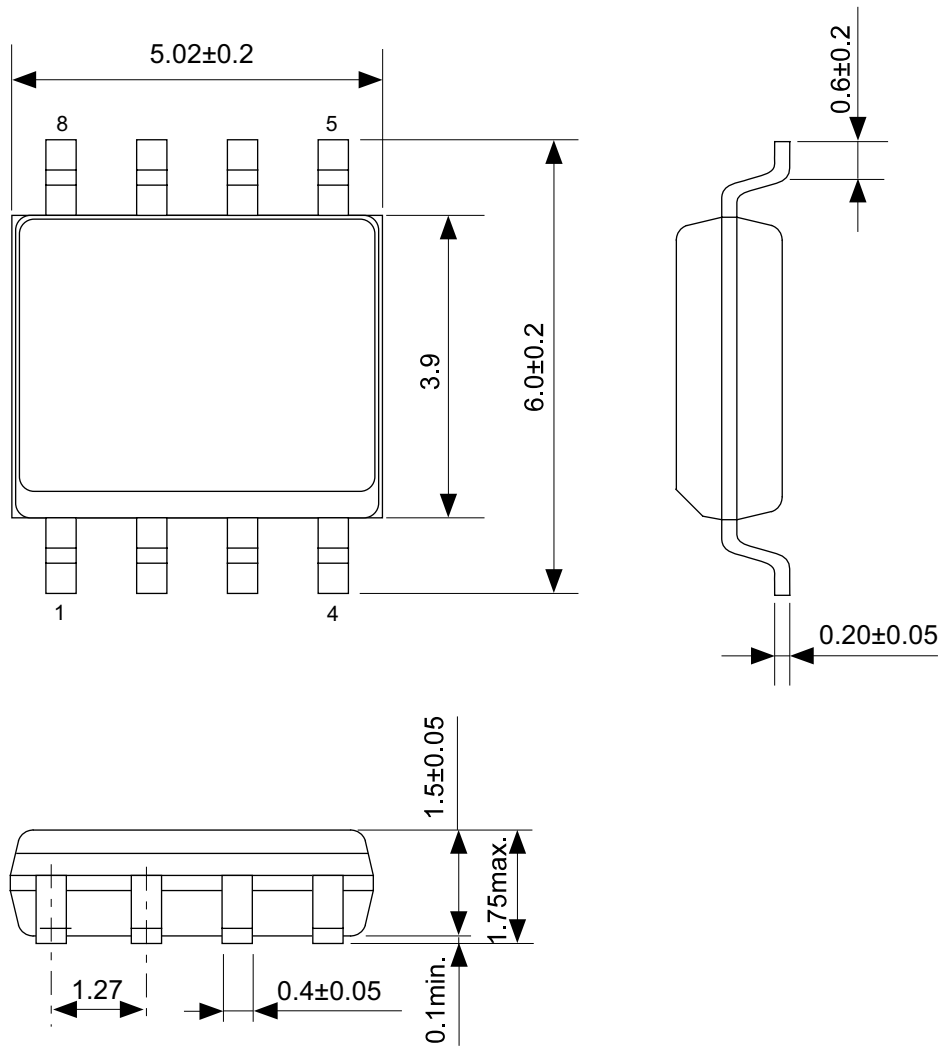

No. FJ008-A-P-SD-2.1

TITLE	SOP8J-D-PKG Dimensions
No.	FJ008-A-P-SD-2.1
SCALE	
UNIT	mm
SII Semiconductor Corporation	

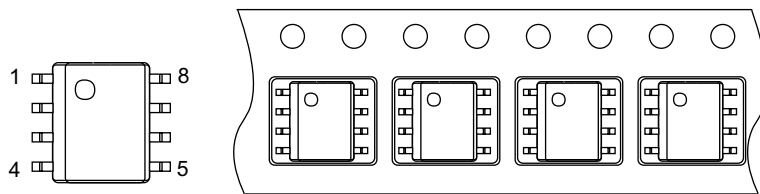
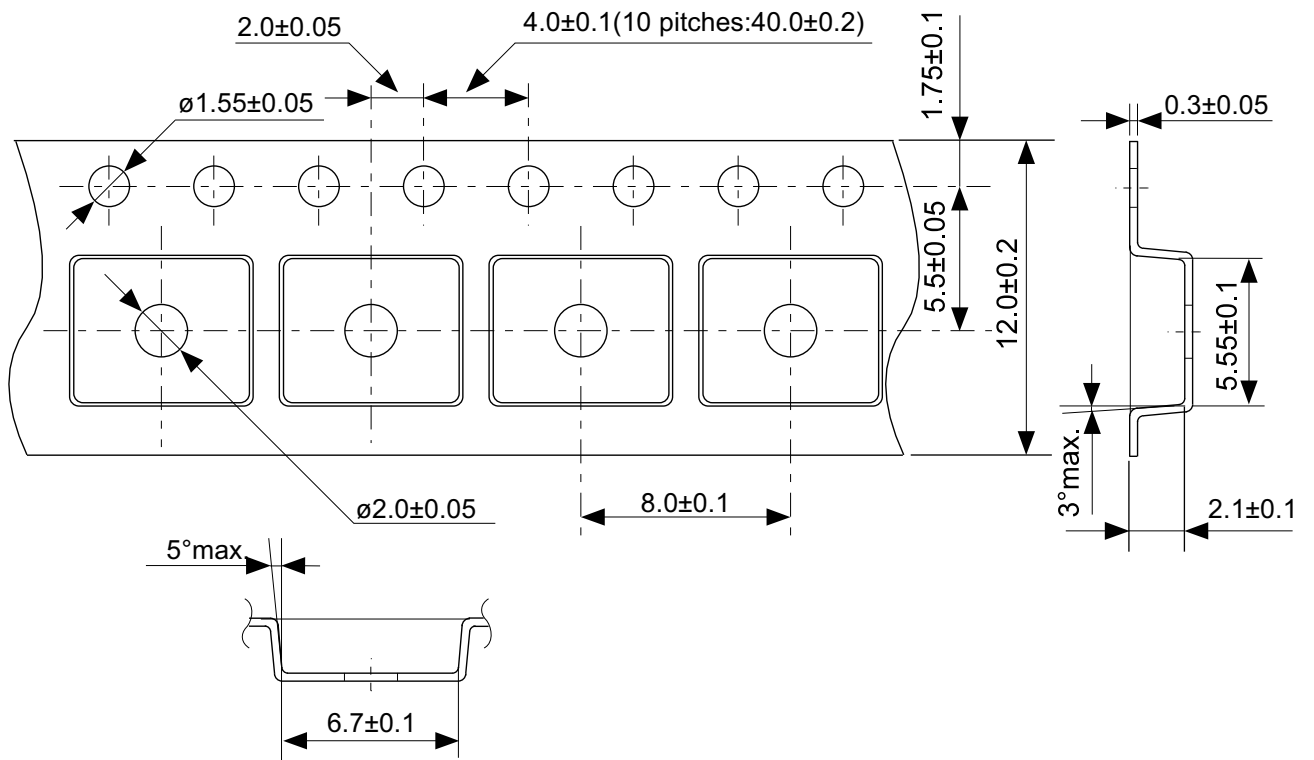

Feed direction →

No. FJ008-D-C-SD-1.1

TITLE	SOP8J-D-Carrier Tape
No.	FJ008-D-C-SD-1.1
SCALE	
UNIT	mm
SII Semiconductor Corporation	

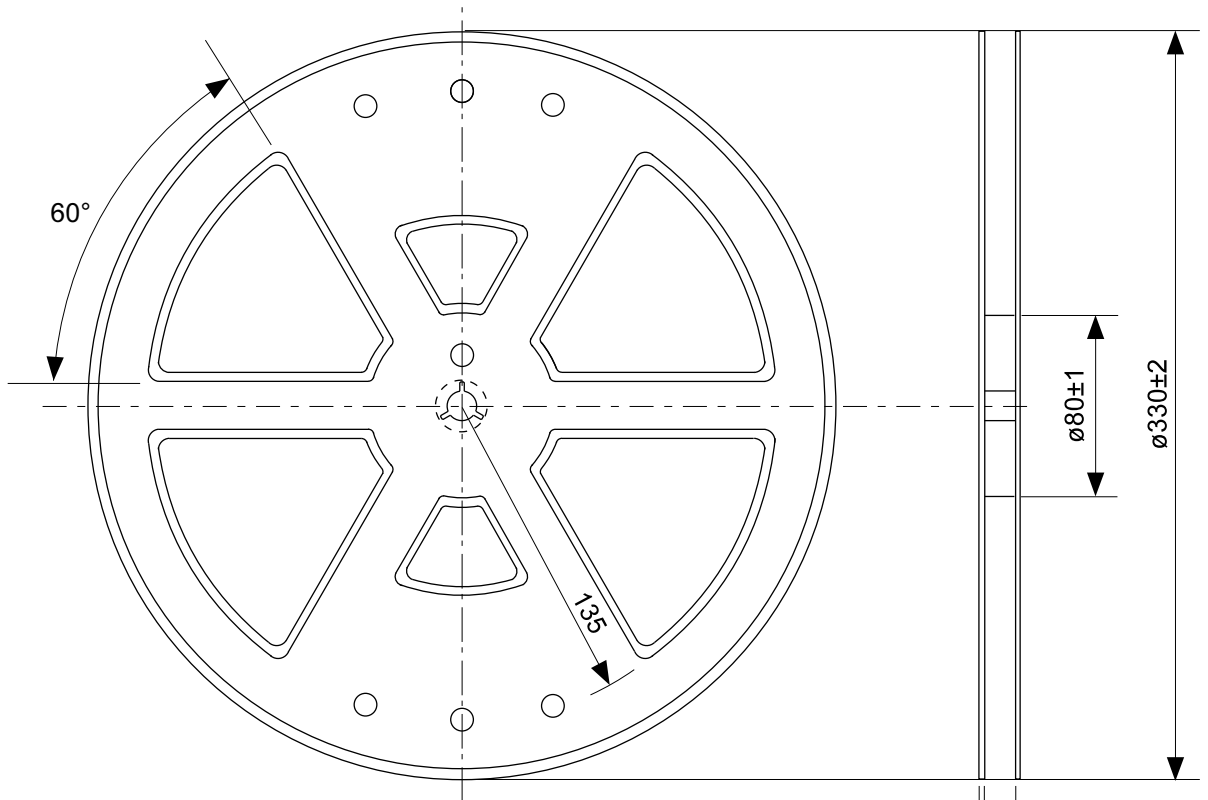

Enlarged drawing in the central part

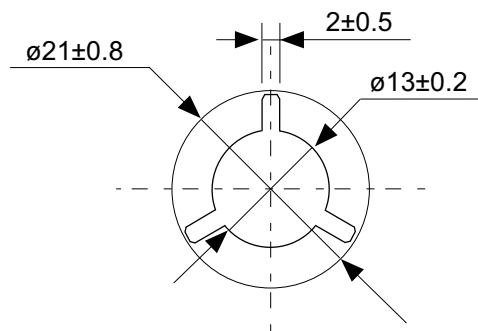

No. FJ008-D-R-SD-1.1

TITLE	SOP8J-D-Reel		
No.	FJ008-D-R-SD-1.1		
SCALE		QTY.	2,000
UNIT	mm		
SII Semiconductor Corporation			

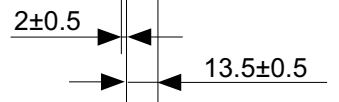
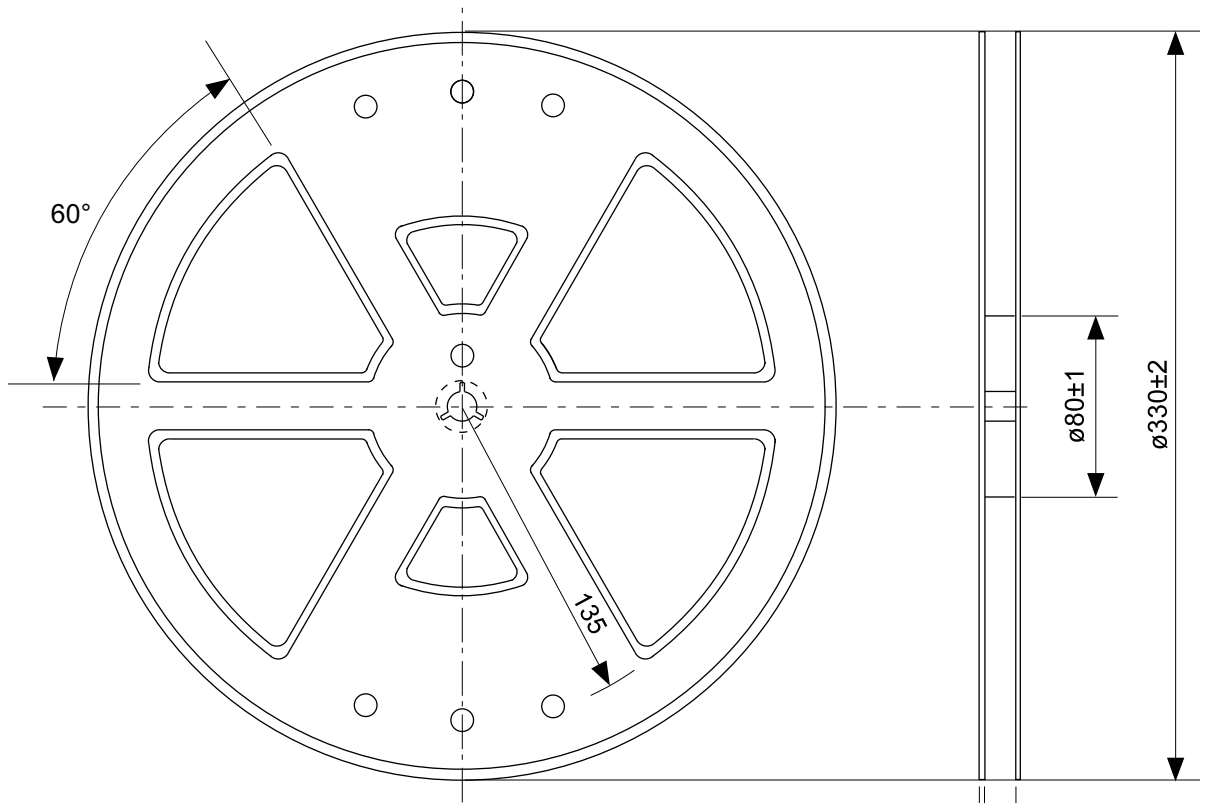

Enlarged drawing in the central part

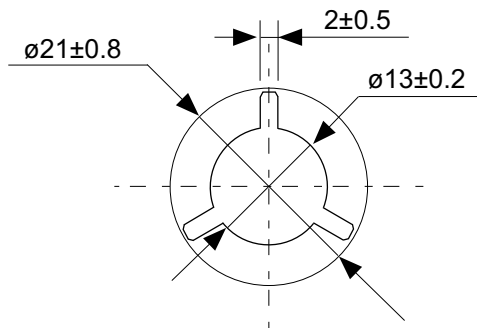

No. FJ008-D-R-S1-1.0

TITLE	SOP8J-D-Reel		
No.	FJ008-D-R-S1-1.0		
SCALE		QTY.	4,000
UNIT	mm		

SII Semiconductor Corporation

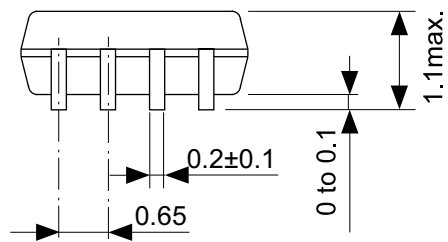
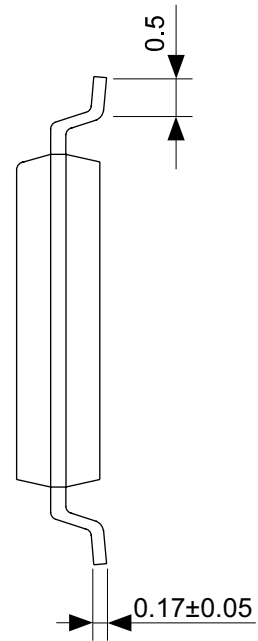
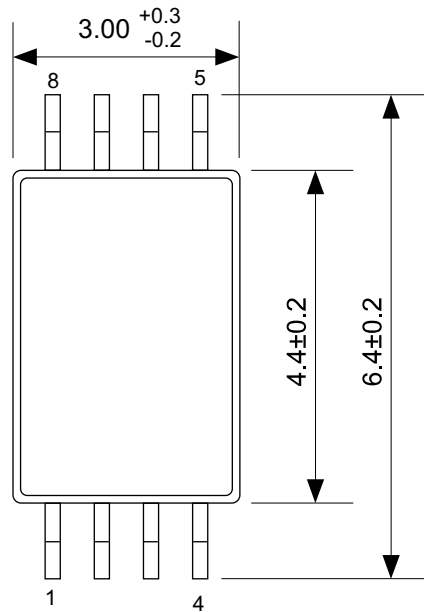

No. FT008-A-P-SD-1.1

TITLE	TSSOP8-E-PKG Dimensions
No.	FT008-A-P-SD-1.1
SCALE	
UNIT	mm
SII Semiconductor Corporation	

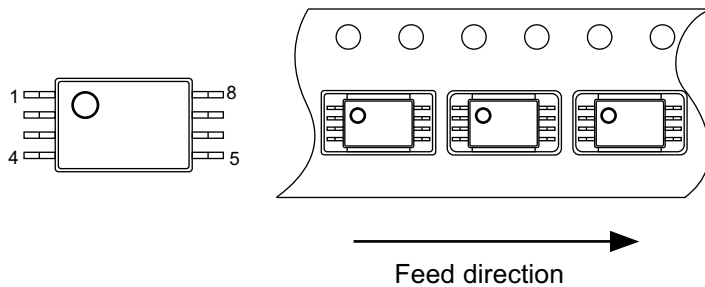
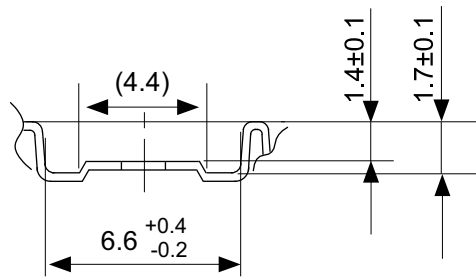

No. FT008-E-C-SD-1.0

TITLE	TSSOP8-E-Carrier Tape
No.	FT008-E-C-SD-1.0
SCALE	
UNIT	mm
SII Semiconductor Corporation	



Enlarged drawing in the central part

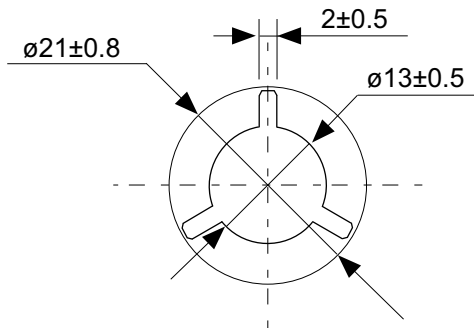

No. FT008-E-R-SD-1.0

TITLE	TSSOP8-E-Reel		
No.	FT008-E-R-SD-1.0		
SCALE		QTY.	3,000
UNIT	mm		
SII Semiconductor Corporation			



Enlarged drawing in the central part



No. FT008-E-R-S1-1.0

TITLE	TSSOP8-E-Reel		
No.	FT008-E-R-S1-1.0		
SCALE		QTY.	4,000
UNIT	mm		
SII Semiconductor Corporation			

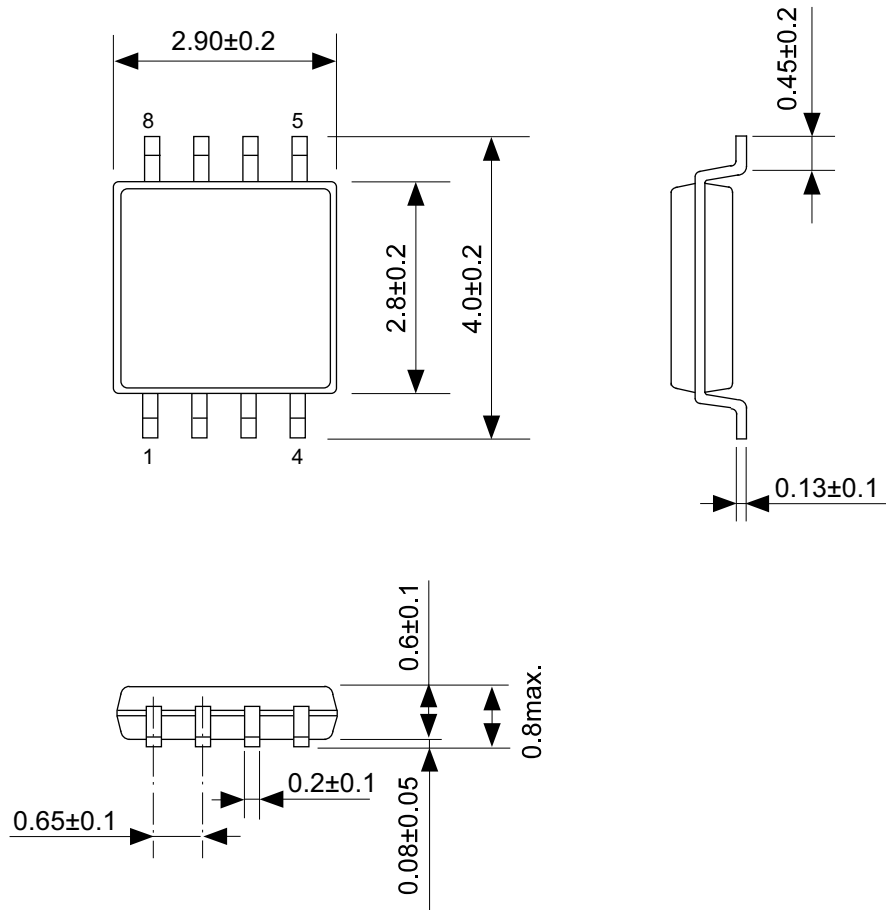

No. FM008-A-P-SD-1.1

TITLE	TMSOP8-A-PKG Dimensions
No.	FM008-A-P-SD-1.1
SCALE	
UNIT	mm
SII Semiconductor Corporation	

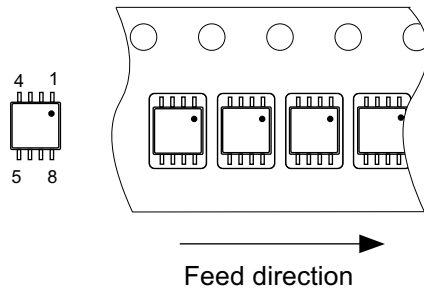
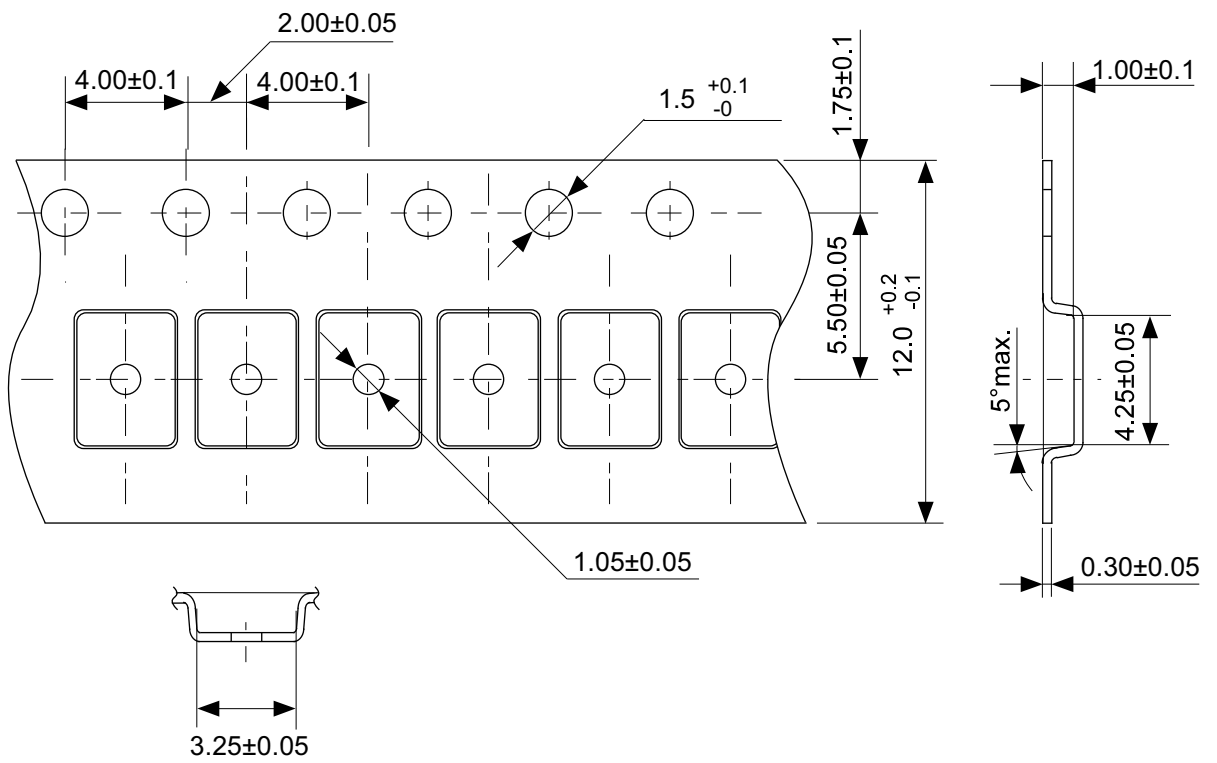

No. FM008-A-C-SD-2.0

TITLE	TMSOP8-A-Carrier Tape
No.	FM008-A-C-SD-2.0
SCALE	
UNIT	mm
SII Semiconductor Corporation	

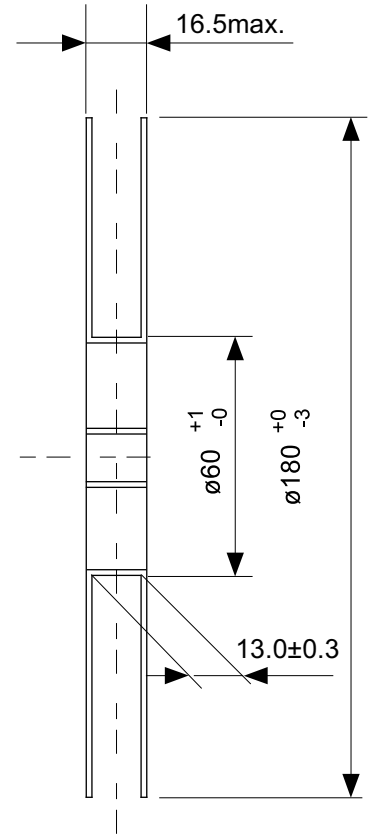
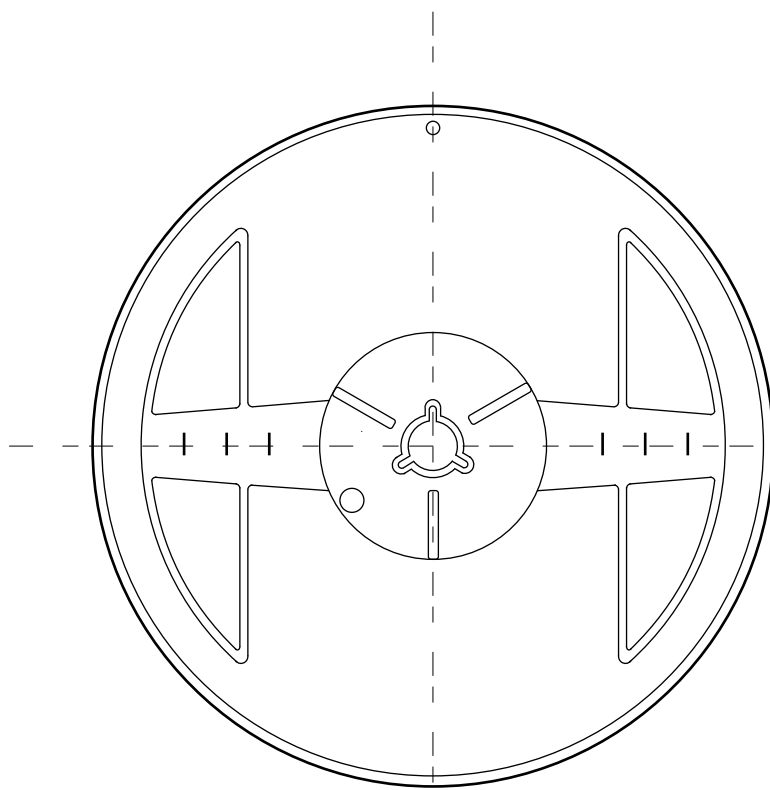

Enlarged drawing in the central part

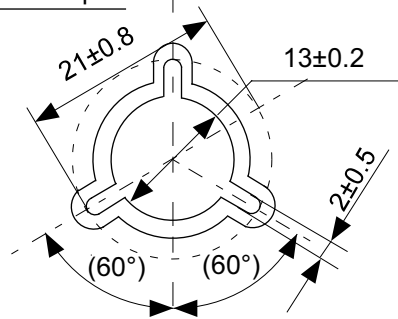

No. FM008-A-R-SD-1.0

TITLE	TMSOP8-A-Reel		
No.	FM008-A-R-SD-1.0		
SCALE		QTY.	4,000
UNIT	mm		
SII Semiconductor Corporation			

Disclaimers (Handling Precautions)

1. All the information described herein (product data, specifications, figures, tables, programs, algorithms and application circuit examples, etc.) is current as of publishing date of this document and is subject to change without notice.
2. The circuit examples and the usages described herein are for reference only, and do not guarantee the success of any specific mass-production design.
SII Semiconductor Corporation is not responsible for damages caused by the reasons other than the products or infringement of third-party intellectual property rights and any other rights due to the use of the information described herein.
3. SII Semiconductor Corporation is not responsible for damages caused by the incorrect information described herein.
4. Take care to use the products described herein within their specified ranges. Pay special attention to the absolute maximum ratings, operation voltage range and electrical characteristics, etc.
SII Semiconductor Corporation is not responsible for damages caused by failures and/or accidents, etc. that occur due to the use of products outside their specified ranges.
5. When using the products described herein, confirm their applications, and the laws and regulations of the region or country where they are used and verify suitability, safety and other factors for the intended use.
6. When exporting the products described herein, comply with the Foreign Exchange and Foreign Trade Act and all other export-related laws, and follow the required procedures.
7. The products described herein must not be used or provided (exported) for the purposes of the development of weapons of mass destruction or military use. SII Semiconductor Corporation is not responsible for any provision (export) to those whose purpose is to develop, manufacture, use or store nuclear, biological or chemical weapons, missiles, or other military use.
8. The products described herein are not designed to be used as part of any device or equipment that may affect the human body, human life, or assets (such as medical equipment, disaster prevention systems, security systems, combustion control systems, infrastructure control systems, vehicle equipment, traffic systems, in-vehicle equipment, aviation equipment, aerospace equipment, and nuclear-related equipment), excluding when specified for in-vehicle use or other uses. Do not use those products without the prior written permission of SII Semiconductor Corporation. Especially, the products described herein cannot be used for life support devices, devices implanted in the human body and devices that directly affect human life, etc.
Prior consultation with our sales office is required when considering the above uses.
SII Semiconductor Corporation is not responsible for damages caused by unauthorized or unspecified use of our products.
9. Semiconductor products may fail or malfunction with some probability.
The user of these products should therefore take responsibility to give thorough consideration to safety design including redundancy, fire spread prevention measures, and malfunction prevention to prevent accidents causing injury or death, fires and social damage, etc. that may ensue from the products' failure or malfunction.
The entire system must be sufficiently evaluated and applied on customer's own responsibility.
10. The products described herein are not designed to be radiation-proof. The necessary radiation measures should be taken in the product design by the customer depending on the intended use.
11. The products described herein do not affect human health under normal use. However, they contain chemical substances and heavy metals and should therefore not be put in the mouth. The fracture surfaces of wafers and chips may be sharp. Take care when handling these with the bare hands to prevent injuries, etc.
12. When disposing of the products described herein, comply with the laws and ordinances of the country or region where they are used.
13. The information described herein contains copyright information and know-how of SII Semiconductor Corporation.
The information described herein does not convey any license under any intellectual property rights or any other rights belonging to SII Semiconductor Corporation or a third party. Reproduction or copying of the information described herein for the purpose of disclosing it to a third-party without the express permission of SII Semiconductor Corporation is strictly prohibited.
14. For more details on the information described herein, contact our sales office.

1.0-2016.01

