

Piezo Switch N.O.



PSE M19



Description

- Available in version Standard and lettered, from diameter 22 mm with Point Illumination or Ring Illumination
- Assembly by mounting with nut
- Pins, Wire, Crimp Terminal male or Cable with Faston

Approvals

- EMC: EMC directive 2004/108/EWG
- DGUV Test Certificate: FW 11040 Requirements for Food Processing Equipment
- MIL-STD Certificate Number: 202F Method 107G, 202F Method 204D, 202F Method 213B, 416D Method RS103, 810E Method 501.3, 810E Method 502.3, 810E Method 507.3
- VDE Certificate Number: DIN EN 61000-4-2, DIN EN 61000-4-4, DIN EN 61000-4-5

Characteristics

- Housing material types: plastic, aluminum or stainless steel, ring illuminated version additionally made of polyamide
- Variety of design options regarding size, colour, shape, connection or lettering
- High reliability, long lifetime with more than 20 mill. actuations
- For use in harsh environments, both indoors and outdoors

Other versions on request

- switch for longer switching signal duration, type: PSE IV
- switch for explosion proof applications, type: PSE EX
- switch with enhanced vandal proof protection, type: PSE HI
- as keypad, type: Piezo Keypad

References

- Alternative: switch with prolonged signal: [PSE IV 19](#)
- Alternative: switch for EX proved applications: [PSE EX 19](#)

Weblinks

[html-datasheet](#), [General Product Information](#), [CE declaration of conformity](#), [RoHS](#), [CHINA-RoHS](#), [e-Shop](#), [CAD-Drawings](#), [Product News](#), [Detailed request for product](#)

Technical Data

Electrical Data

Switching Function	N.O.
Supply Voltage	12 / 24 VDC Ring Illumination, 24 VDC Point Illumination,
Switching Voltage	max. 42 / 60 VAC/DC
Switching Current	max. 100 mA
Rated Breaking Capacity	1 W
Lifetime	20 million at Rated Switching Capacity
Switch Resistance OFF	> 10 MΩ
Switch Resistance ON	< 20Ω actuated (Ta = 25°C)
Capacity	5 nF
N.O. Closing Impulse Duration	20- 1000 ms depending on actuating force, time and speed
Contact Configuration	free polarity

Mechanical Data

Actuating Force	≤ 3 N at ambient temperature
Actuating Travel	0.002 mm
Shock Protection	IK 02
Tightening Torque	2.5 Nm

Climatical Data

Operating Temperature	-40 to +85 °C
Storage Temperature	-40 to +85 °C
IP-Protection	IP 67 Front Side submerged (1m water column), IP 69K Front side High Pressure cleaner test, front side / rear side DIN EN 60068-2-30 Db (Moist heat - air test with 55°C / 93% humidity)

Salt Spray Test (acc. to DIN 50021-SS)	24 h / 48 h / 96 h Residence Time
--	-----------------------------------

Material

Housing (depending on type)	Stainless Steel, Aluminium anodized, Polyamide
Actuating Area / Insert (with Ring Illumination)	Stainless Steel, Aluminium anodized
Illuminated Ring (Ring Illumination)	Polyamide

Dimension

PSE M19 with Pins

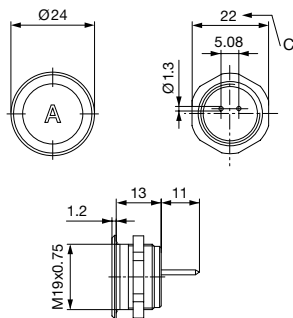

PSE M19 with Crimp Terminal male

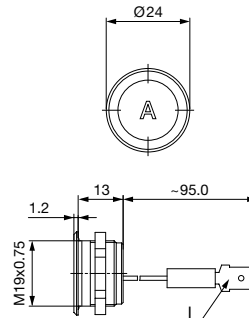

Version available on request

PSE M19 with Cable with Faston, elevated front design

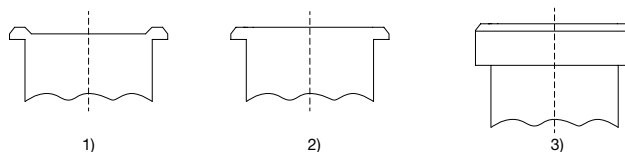
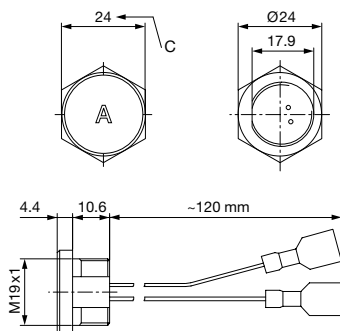

Terminal: Crimp Terminal female Ultrafast red 6.3 x 0.8

Legend:

- A = Illumination Area
- B = Actuating Area
- C = Width Across Flats
- I = Crimp Terminal male 6.3 x 0.8
- PI = Point Illumination
- RI = Ring Illumination

Lettering:

- either with/without lettering
- position of the connections with respect to the position of the lettering is not defined

- 1) with finger guidance (standard)
- 2) without finger guidance (on request)
- 3) elevated front design: M19 (standard, others on request)

Dimension

PSE M19

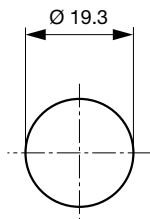

Drilling diagram

Lettering

The last three digits in the order number define the lettering:

001-076	Standard Lettering
101-	Customized Lettering

Lettering - Aluminium / Plastic Material

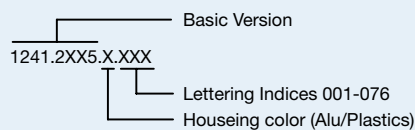

Lettering - Stainless Steel

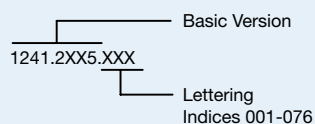

Order Index Lettering

Laser Marking

001 = A	021 = U	041 = ÷	061 = EIN
002 = B	022 = V	042 = *	062 = AUS
003 = C	023 = W	043 = =	063 = AUF
004 = D	024 = X	044 = #	064 = AB
005 = E	025 = Y	045 = ↔	065 = ON
006 = F	026 = Z	046 = †	066 = OFF
007 = G	027 = 0	047 = →	067 = UP
008 = H	028 = 1	048 = ←	068 = DOWN
009 = I	029 = 2	049 = ↓	069 = HIGH
010 = J	030 = 3	050 = ↑	070 = LOW
011 = K	031 = 4	051 = %	071 = ON/OFF
012 = L	032 = 5	052 = √	072 = START
013 = M	033 = 6	053 = CTRL	073 = RESET
014 = N	034 = 7	054 = RETURN	074 =
015 = O	035 = 8	055 = SHIFT	075 =
016 = P	036 = 9	056 = LOCK	076 =
017 = Q	037 = +	057 = STOP	
018 = R	038 = -	058 = ENTER	
019 = S	039 = .	059 = BACK	
020 = T	040 = x	060 = LINE	

All Variants

Mounting Diameter	Terminal	Housing Material, Torsion Protection	Colour of Housing	Actuator area	Illumination, LED	Config. Code	Order Number
19	Cable with Faston	Aluminum ,yes	Alu natural	Elevated Front	non-illuminated	PSE M 19 NO	1241.5003
19	Pins	Aluminum ,no	Alu natural	F	non-illuminated	PSE M 19 NO	1241.3123
19	Pins	Stainless Steel ,no	-	F	non-illuminated	PSE M 19 NO	1241.3388

Legend:

Type: PSE

NO = normaly open

IV = prolonged signal

RU = PI = Point Illumination

RI = Ring Illumination

LE = Lettered

K = Plastics

Alu = Aluminium

ES = Stainless steel

F = Finger guidance

E = without finger guidance

Plastic nut with gasket are enclosed in the box.

Other mounting diameters, materials, colors, connections, supply voltages possible available on request.

Special materials for use in salt and chlorinated environment on request.

Most Popular.

Availability for all products can be searched real-time:<http://www.schurter.com/en/Stock-Check/Stock-Check-SCHURTER>

Packaging unit 10 in box with insert or packed in air cushion bags



- Actuating elements in ESD safe packaging

- Screw nuts and sealing rings in a bag (enclosed in the box)

Accessories

Description



Connecting Terminal PSE
Connecting Terminal