

IEC Appliance Inlet C14 with Filter, Fuseholder 1- or 2-pole, optional Voltage Selector (step switch)

Plug removal necessary for fuse replacement



Screw-on mounting from front side
Version with ground line choke
without voltage selector
Fuse drawer must be ordered separately (see accessories).



Snap-in mounting from front side
without voltage selector
Fuse drawer must be ordered separately (see accessories).



Screw-on mounting from rear side
without voltage selector
Fuse drawer must be ordered separately (see accessories).



Description

- Panel Mount:
Screw-on version from front or rear side, snap-in version from front side
- 4 Functions:
Appliance Inlet Protection class I, Fuseholder for fuse-links 5 x 20 mm 1- or 2-pole, with or without voltage selector (step switch), Line filter in standard and medical version
- V-Lock notch standard
- Quick connect terminals or wires

Unique Selling Proposition

- Reduces noise on the ground wire
- Interrupts ground loops
- High asymmetrical attenuation
- V-Lock cord retaining

Approvals

- VDE Certificate Number: 40004665 (FKE, FKF, FKV, FKW)
- UL File Number: E72928 (FKE, FKF, FKV, FKW)

Technical Data

Ratings IEC	1 - 10A @ Ta 40 °C / 250VAC; 50Hz
Ratings UL/CSA	1 - 10A @ Ta 40 °C / 125VAC; 60Hz
Leakage Current	standard < 0.5 mA (250V / 60Hz) medical < 5 µA (250 V / 60 Hz)
Dielectric Strength	> 1.7 kVDC between L-N > 2.7 kVDC between L/N-PE Test voltage (2 sec)
Allowable Operation Temp.	-25 °C to 85 °C
Climatic Category	25/085/21 acc. to IEC 60068-1
IP-Protection	from front side IP 40 acc. to IEC 60529
Protection Class	Suitable for appliances with protection class I acc. to IEC 61140
Terminal	Quick connect terminals 6.3 x 0.8 mm Flexible wire AWG18, 150 mm
Panel Thickness s	Screw: max 8 mm Mounting screw torque max 0.5 Nm Snap-in: 0.8 mm to 3 mm
Material: Housing	Thermoplastic, black, UL 94V-0

Characteristics

- Rear side mounting for efficient cost-saving assembly
- Suitable for assembly in metal plated plastic housings
- All single elements are already wired
- Plug removal necessary for fuse-link replacement
- Suitable for use in equipment according to IEC/UL 60950
- Suitable for use in medical equipment according to IEC/UL 60601-1

Other versions on request

- Capacity CX 100 nF

References

Alternative: version without line filter [KEA](#)
Alternative: Standard version

Weblinks

[pdf-datasheet](#), [html-datasheet](#), [General Product Information](#), [RoHS](#), [CHINA-RoHS](#), [REACH](#), [Distributor-Stock-Check](#), [Accessories](#), [Detailed request for product](#)

appliance inlet/-outlet	C14 acc. to IEC 60320-1, UL 498, CSA C22.2 no. 42 (for cold conditions) pin-temperature 70 °C, 10A, Protection Class I
Fuseholder	1 or 2 pole, Shocksafe category PC2 acc. to IEC 60127-6, for fuse-links 5 x 20 mm
Rated Power Acceptance @ Ta 23 °C	5 x 20: 2W (1 pole)/ 1.6W (2-pole) per pole
Power Acceptance @ Ta > 23°C	Admissible power acceptance at higher ambient temperature see derating curves
Voltage Selector	optional, step, 3 pos.
Line Filter	Standard and Medical Version, IEC 60939, UL 1283, CSA C22.2 no. 8 Technical Details
MTBF	> 1'700'000 h acc. to MIL-HB-217 F

Dimension

Screw-on mounting from front side

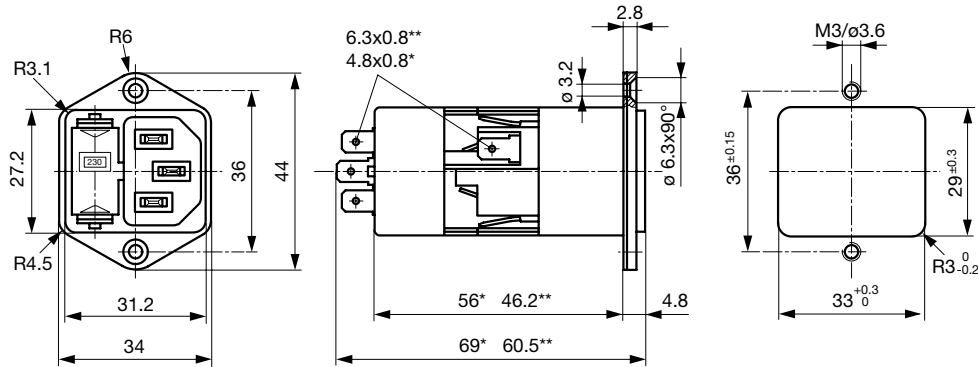

* with voltage selector

** without voltage selector

Screw-on mounting from rear side

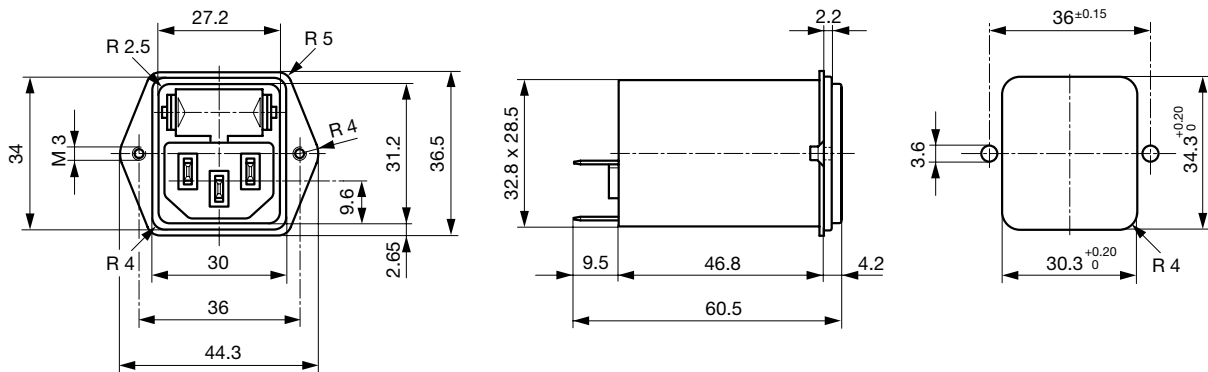

Snap-in mounting

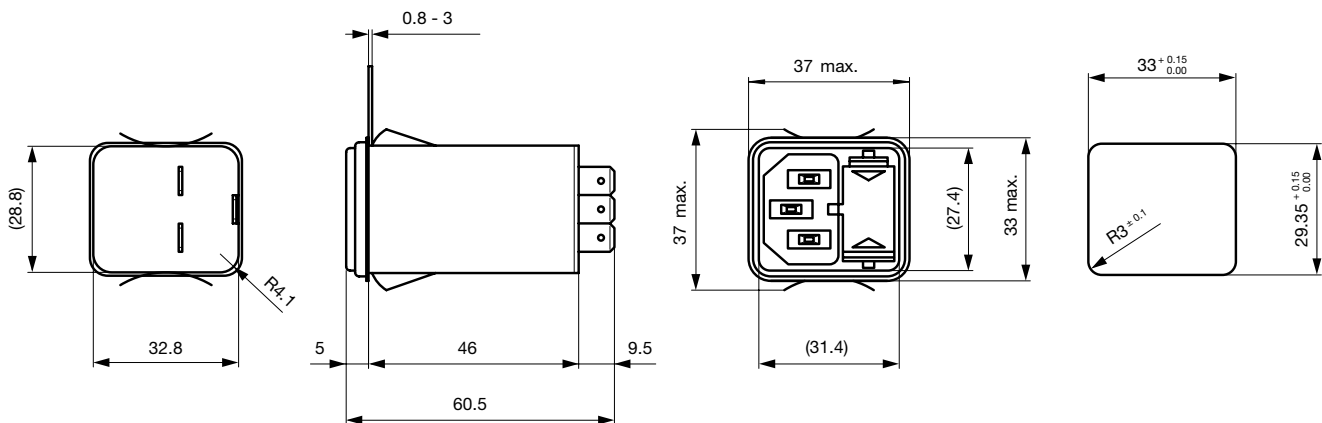

Screw-on mounting from front side with ground line choke

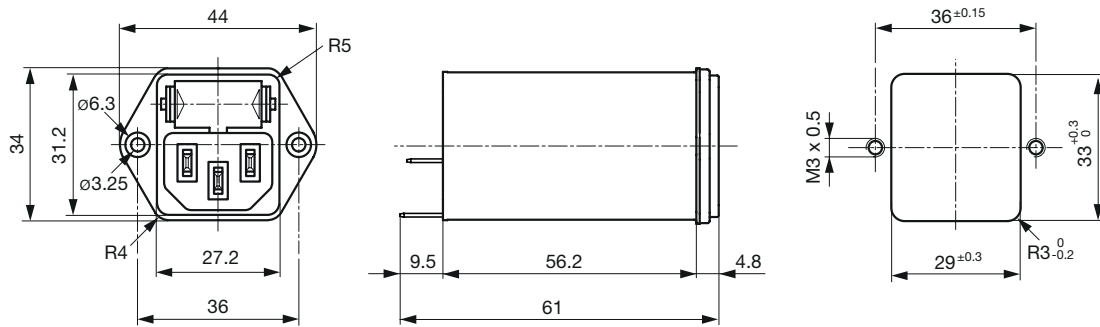

Technical Data of Filter-Components

Rated Current [A]	Filter-Type	Inductance L1/ L2 [mH]	Inductance L3 [mH]	Capacitance CX [nF]	Capacitance CY [nF]	R [MΩ]
1	Standard Version	2 x 10	-	68	2.2	-
2	Standard Version	2 x 4	-	68	2.2	-
4	Standard Version	2 x 1.5	-	68	2.2	-
6	Standard Version	2 x 0.8	-	68	2.2	-
10	Standard Version	2 x 0.3	-	68	2.2	-
1	Standard Version with Ground Line Choke	2 x 10	0.6	100	2.2	-
2	Standard Version with Ground Line Choke	2 x 4	0.6	100	2.2	-
4	Standard Version with Ground Line Choke	2 x 1.5	0.6	100	2.2	-
6	Standard Version with Ground Line Choke	2 x 0.8	0.6	100	2.2	-
10	Standard Version with Ground Line Choke	2 x 0.3	0.6	100	2.2	-
1	Medical Version (M5)	2 x 10	-	68	-	1
2	Medical Version (M5)	2 x 4	-	68	-	1
4	Medical Version (M5)	2 x 1.5	-	68	-	1
6	Medical Version (M5)	2 x 0.8	-	68	-	1
10	Medical Version (M5)	2 x 0.3	-	68	-	1
1	Medical Version (M80)	2 x 10	-	68	0.47	1
2	Medical Version (M80)	2 x 4	-	68	0.47	1
4	Medical Version (M80)	2 x 1.5	-	68	0.47	1
6	Medical Version (M80)	2 x 0.8	-	68	0.47	1
10	Medical Version (M80)	2 x 0.3	-	68	0.47	1
1	Medical Version (M5) with Ground Line Choke	2 x 10	0.15	100	-	1
2	Medical Version (M5) with Ground Line Choke	2 x 4	0.6	100	-	1
4	Medical Version (M5) with Ground Line Choke	2 x 1.5	0.6	100	-	1
6	Medical Version (M5) with Ground Line Choke	2 x 0.8	0.6	100	-	1
10	Medical Version (M5) with Ground Line Choke	2 x 0.3	0.15	100	-	1

Diagrams

Standard version with voltage selector

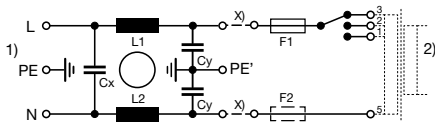

x) external connection to be made by the customer
1) Line
2) Load

Standard version without voltage selector

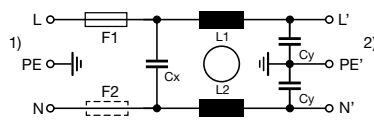

1) Line
2) Load

Medical version (M5) with voltage selector

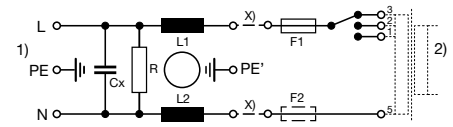

x) external connection to be made by the customer
1) Line
2) Load

Medical version (M5) without voltage selector

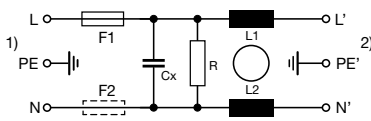

1) Line
2) Load

Medical version (M80) with voltage selector

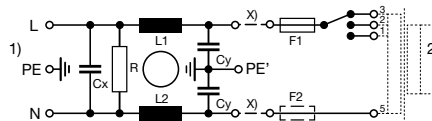

x) external connection to be made by the customer
1) Line
2) Load

Medical version (M80) without voltage selector

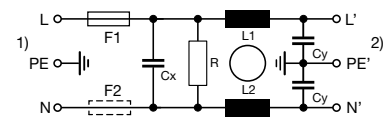

1) Line
2) Load

Standard version with ground line choke

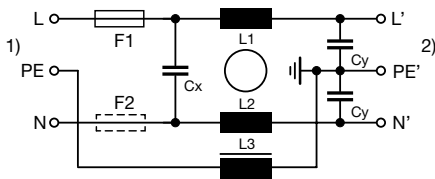

1) Line
2) Load

Medical version (M5) with ground line choke

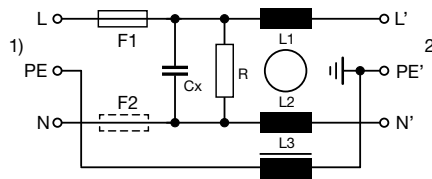

1) Line
2) Load

Medical version (M80) with ground line choke

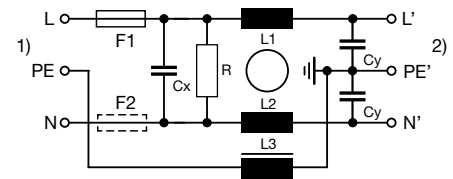

1) Line
2) Load

Derating Curves

1-pole

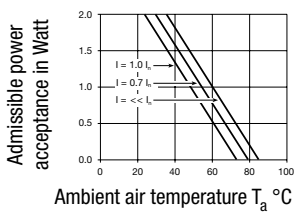

2-pole

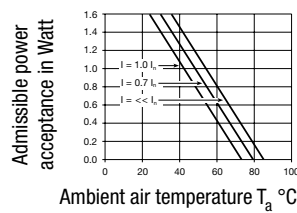

Standard with Earth Line Choke

1 A

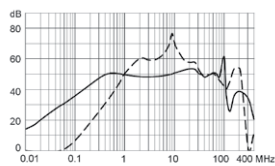

2 A

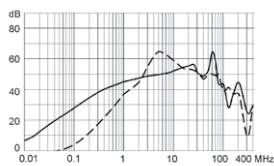

4 A

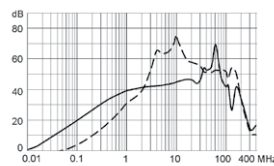

6 A

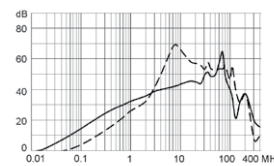

10 A

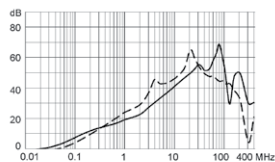

Medical (M5) with Earth Line Choke

1 A

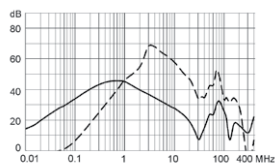

2 A

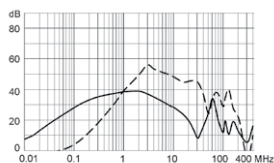

4 A

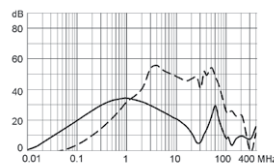

6 A

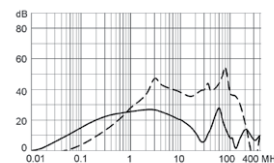

10 A

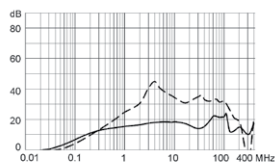

All Variants

Rated Current [A]	Filter-Type	Panel mounting	Mounting side	Fuseholder	Terminal	Voltage Selector	Order Number
1	Standard Version	Snap-in	Front Side	1-pole	Quick connect terminals 6.3 x 0.8 mm	-	4301.6011
1	Standard Version	Snap-in	Front Side	2-pole	Quick connect terminals 6.3 x 0.8 mm	-	4301.6001
2	Standard Version	Snap-in	Front Side	1-pole	Quick connect terminals 6.3 x 0.8 mm	-	4301.6012
2	Standard Version	Snap-in	Front Side	2-pole	Quick connect terminals 6.3 x 0.8 mm	-	4301.6002
4	Standard Version	Snap-in	Front Side	1-pole	Quick connect terminals 6.3 x 0.8 mm	-	4301.6013
4	Standard Version	Snap-in	Front Side	2-pole	Quick connect terminals 6.3 x 0.8 mm	-	4301.6003
6	Standard Version	Snap-in	Front Side	1-pole	Quick connect terminals 6.3 x 0.8 mm	-	4301.6014
6	Standard Version	Snap-in	Front Side	2-pole	Quick connect terminals 6.3 x 0.8 mm	-	4301.6004
10	Standard Version	Snap-in	Front Side	1-pole	Quick connect terminals 6.3 x 0.8 mm	-	4301.6015
10	Standard Version	Snap-in	Front Side	2-pole	Quick connect terminals 6.3 x 0.8 mm	-	4301.6005
1	Standard Version	Screw	Front Side	1-pole	Quick connect terminals 6.3 x 0.8 mm	-	4301.5011
1	Standard Version	Screw	Front Side	1-pole	Quick connect terminals 6.3 x 0.8 mm	3 pos.	4301.5051

Rated Current [A]	Filter-Type	Panel mounting	Mounting side	Fuseholder	Terminal	Voltage Selector	Order Number
1	Standard Version	Screw	Front Side	2-pole	Quick connect terminals 6.3 x 0.8 mm	-	4301.5001
1	Standard Version	Screw	Front Side	2-pole	Quick connect terminals 6.3 x 0.8 mm	3 pos.	4301.5041
1	Standard Version	Screw	Rear Side	1-pole	Flexible wire AWG18	-	4301.7311
1	Standard Version	Screw	Rear Side	2-pole	Flexible wire AWG18	-	4301.7301
1	Standard Version	Screw	Rear Side	2-pole	Quick connect terminals 6.3 x 0.8 mm	-	4301.7001
2	Standard Version	Screw	Front Side	1-pole	Quick connect terminals 6.3 x 0.8 mm	-	4301.5012
2	Standard Version	Screw	Front Side	1-pole	Quick connect terminals 6.3 x 0.8 mm	3 pos.	4301.5052
2	Standard Version	Screw	Front Side	2-pole	Quick connect terminals 6.3 x 0.8 mm	-	4301.5002
2	Standard Version	Screw	Front Side	2-pole	Quick connect terminals 6.3 x 0.8 mm	3 pos.	4301.5042
2	Standard Version	Screw	Rear Side	2-pole	Quick connect terminals 6.3 x 0.8 mm	-	4301.7002
4	Standard Version	Screw	Front Side	1-pole	Quick connect terminals 6.3 x 0.8 mm	-	4301.5013
4	Standard Version	Screw	Front Side	1-pole	Quick connect terminals 6.3 x 0.8 mm	3 pos.	4301.5053
4	Standard Version	Screw	Front Side	2-pole	Quick connect terminals 6.3 x 0.8 mm	-	4301.5003
4	Standard Version	Screw	Front Side	2-pole	Quick connect terminals 6.3 x 0.8 mm	3 pos.	4301.5043
4	Standard Version	Screw	Rear Side	1-pole	Quick connect terminals 6.3 x 0.8 mm	-	4301.7013
4	Standard Version	Screw	Rear Side	2-pole	Quick connect terminals 6.3 x 0.8 mm	-	4301.7003
6	Standard Version	Screw	Front Side	1-pole	Quick connect terminals 6.3 x 0.8 mm	-	4301.5014
6	Standard Version	Screw	Front Side	1-pole	Quick connect terminals 6.3 x 0.8 mm	3 pos.	4301.5054
6	Standard Version	Screw	Front Side	2-pole	Quick connect terminals 6.3 x 0.8 mm	-	4301.5004
6	Standard Version	Screw	Front Side	2-pole	Quick connect terminals 6.3 x 0.8 mm	3 pos.	4301.5044
6	Standard Version	Screw	Rear Side	1-pole	Quick connect terminals 6.3 x 0.8 mm	-	4301.7014
6	Standard Version	Screw	Rear Side	2-pole	Quick connect terminals 6.3 x 0.8 mm	-	4301.7004
10	Standard Version	Screw	Front Side	1-pole	Quick connect terminals 6.3 x 0.8 mm	-	4301.5015
10	Standard Version	Screw	Front Side	1-pole	Quick connect terminals 6.3 x 0.8 mm	3 pos.	4301.5055
10	Standard Version	Screw	Front Side	2-pole	Quick connect terminals 6.3 x 0.8 mm	-	4301.5005
10	Standard Version	Screw	Front Side	2-pole	Quick connect terminals 6.3 x 0.8 mm	3 pos.	4301.5045
10	Standard Version	Screw	Rear Side	1-pole	Quick connect terminals 6.3 x 0.8 mm	-	4301.7015
10	Standard Version	Screw	Rear Side	2-pole	Quick connect terminals 6.3 x 0.8 mm	-	4301.7005
1	Standard Version with Ground Line Choke	Screw	Front Side	2-pole	Quick connect terminals 6.3 x 0.8 mm	-	4301.8050
2	Standard Version with Ground Line Choke	Screw	Front Side	2-pole	Quick connect terminals 6.3 x 0.8 mm	-	4301.8051
4	Standard Version with Ground Line Choke	Screw	Front Side	2-pole	Quick connect terminals 6.3 x 0.8 mm	-	4301.8052
6	Standard Version with Ground Line Choke	Screw	Front Side	2-pole	Quick connect terminals 6.3 x 0.8 mm	-	4301.8053
10	Standard Version with Ground Line Choke	Screw	Front Side	2-pole	Quick connect terminals 6.3 x 0.8 mm	-	4301.8054
1	Medical Version (M5)	Snap-in	Front Side	2-pole	Quick connect terminals 6.3 x 0.8 mm	-	4301.6201

Rated Current [A]	Filter-Type	Panel mounting	Mounting side	Fuseholder	Terminal	Voltage Selector	Order Number
2	Medical Version (M5)	Snap-in	Front Side	2-pole	Quick connect terminals 6.3 x 0.8 mm	-	4301.6203
4	Medical Version (M5)	Snap-in	Front Side	2-pole	Quick connect terminals 6.3 x 0.8 mm	-	4301.6205
6	Medical Version (M5)	Snap-in	Front Side	2-pole	Flexible wire AWG18	-	4301.6307
6	Medical Version (M5)	Snap-in	Front Side	2-pole	Quick connect terminals 6.3 x 0.8 mm	-	4301.6207
1	Medical Version (M5)	Screw	Front Side	2-pole	Quick connect terminals 6.3 x 0.8 mm	3 pos.	4301.5241
1	Medical Version (M5)	Screw	Rear Side	2-pole	Quick connect terminals 6.3 x 0.8 mm	-	4301.7201
2	Medical Version (M5)	Screw	Front Side	2-pole	Quick connect terminals 6.3 x 0.8 mm	-	4301.5203
2	Medical Version (M5)	Screw	Front Side	2-pole	Quick connect terminals 6.3 x 0.8 mm	3 pos.	4301.5243
2	Medical Version (M5)	Screw	Rear Side	2-pole	Quick connect terminals 6.3 x 0.8 mm	-	4301.7203
4	Medical Version (M5)	Screw	Front Side	2-pole	Quick connect terminals 6.3 x 0.8 mm	-	4301.5205
4	Medical Version (M5)	Screw	Front Side	2-pole	Quick connect terminals 6.3 x 0.8 mm	3 pos.	4301.5245
4	Medical Version (M5)	Screw	Rear Side	2-pole	Quick connect terminals 6.3 x 0.8 mm	-	4301.7205
6	Medical Version (M5)	Screw	Front Side	1-pole	Quick connect terminals 6.3 x 0.8 mm	-	4301.5217
6	Medical Version (M5)	Screw	Front Side	2-pole	Quick connect terminals 6.3 x 0.8 mm	3 pos.	4301.5247
6	Medical Version (M5)	Screw	Rear Side	2-pole	Quick connect terminals 6.3 x 0.8 mm	-	4301.7207
10	Medical Version (M5)	Screw	Front Side	2-pole	Quick connect terminals 6.3 x 0.8 mm	-	4301.5209
10	Medical Version (M5)	Screw	Rear Side	2-pole	Quick connect terminals 6.3 x 0.8 mm	-	4301.7209
4	Medical Version (M80)	Snap-in	Front Side	2-pole	Quick connect terminals 6.3 x 0.8 mm	-	4301.6206
1	Medical Version (M80)	Screw	Rear Side	2-pole	Quick connect terminals 6.3 x 0.8 mm	-	4301.7202
2	Medical Version (M80)	Screw	Front Side	2-pole	Quick connect terminals 6.3 x 0.8 mm	-	4301.5204
2	Medical Version (M80)	Screw	Front Side	2-pole	Quick connect terminals 6.3 x 0.8 mm	3 pos.	4301.5244
2	Medical Version (M80)	Screw	Rear Side	2-pole	Quick connect terminals 6.3 x 0.8 mm	-	4301.7204
4	Medical Version (M80)	Screw	Front Side	2-pole	Quick connect terminals 6.3 x 0.8 mm	-	4301.5206
4	Medical Version (M80)	Screw	Rear Side	2-pole	Quick connect terminals 6.3 x 0.8 mm	-	4301.7206
6	Medical Version (M80)	Screw	Rear Side	2-pole	Quick connect terminals 6.3 x 0.8 mm	-	4301.7208
10	Medical Version (M80)	Screw	Front Side	2-pole	Quick connect terminals 6.3 x 0.8 mm	-	4301.5200
10	Medical Version (M80)	Screw	Rear Side	2-pole	Quick connect terminals 6.3 x 0.8 mm	-	4301.7200
1	Medical Version (M5) with Ground Line Choke	Screw	Front Side	2-pole	Quick connect terminals 6.3 x 0.8 mm	-	4301.8055
2	Medical Version (M5) with Ground Line Choke	Screw	Front Side	2-pole	Quick connect terminals 6.3 x 0.8 mm	-	4301.8056
4	Medical Version (M5) with Ground Line Choke	Screw	Front Side	2-pole	Quick connect terminals 6.3 x 0.8 mm	-	4301.8057
6	Medical Version (M5) with Ground Line Choke	Screw	Front Side	2-pole	Quick connect terminals 6.3 x 0.8 mm	-	4301.8058
10	Medical Version (M5) with Ground Line Choke	Screw	Front Side	2-pole	Quick connect terminals 6.3 x 0.8 mm	-	4301.8059

 Most Popular.

Availability for all products can be searched real-time: <http://www.schurter.com/Stock-Check/Stock-Check-SCHURTER>



Wire length: 150 mm

Packaging unit 10 Pcs

Required Accessory

Description		
	Fusedrawer 2 Fusedrawer für Fuse Links 5x20 mm, with or without Voltage Selector Insert	
	Fingerrip, 2-pole, Voltage Selector, 110, 150, 220	4301.1014.01
	Fingerrip, 2-pole, Voltage Selector, 120, 240	4301.1014.02
	Fingerrip, 2-pole, Voltage Selector, 110, 220	4301.1014.03
	Fingerrip, 2-pole, Voltage Selector, 115, 220	4301.1014.04
	...	

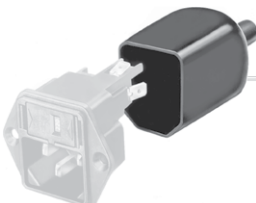
Accessories

	Wire Harness Wire harness for SCHURTER products	
	Assorted Covers Rear Cover	0859.0072
	Cord retaining kits Cord retaining strain relief	
	Flat head, A	4700.0001
	Countersunk, B	4700.0002

Mating Outlets/Connectors

Category / Description		
	Appliance Outlet Overview complete	
	IEC Appliance Outlet F, Screw-on Mounting, Front Side, Solder Terminal	4787
	IEC Appliance Outlet F, Snap-in Mounting, Front Side, Solder or Quick-connect Terminal	4788
	IEC Appliance Outlet F or H, Screw-on Mounting, Front Side, Solder, PCB or Quick-connect Terminal	5091
	Appliance Outlet further types to KFA	



[Connector Overview complete](#)

4782 Mounting: Power Cord, 3 x 1 mm ² / 3 x 18 AWG, Cable, Connector: IEC C13	4782
4022 Mounting: Power Supply Cord, 3 x 1.5 mm ² , Screw clamps, Connector: IEC C13	4022
4785 Mounting: Power Cord, 3 x 1 mm ² / 3 x 18 AWG, Cable, Connector: IEC C13	4785
4300-06 Mounting: Power Cord, 3 x 1 mm ² / 3 x 18 AWG, Cable, Connector: IEC C13	4300-06
4012 Mounting: Power Supply Cord, 3 x 1.5 mm ² , Screw clamps, Connector: IEC C13	4012
Connector further types to KFA	...

Mating Outlets/Connectors shuttered



[Power Cord Overview complete](#)

VAC13KS, Overview, diverse Connector IEC C13, cord end:	VAC13KS
Power Cord further types to KFA	