

4W AUDIO AMPLIFIER

- HIGH OUTPUT CURRENT CAPABILITY
- PROTECTION AGAINST CHIP OVERTEMPERATURE
- LOW NOISE
- HIGH SUPPLY VOLTAGE REJECTION
- SUPPLY VOLTAGE RANGE: 4V TO 20V

DESCRIPTION

The TDA 1904 is a monolithic integrated circuit in POWERDIP package intended for use as low-frequency power amplifier in wide range of applications in portable radio and TV sets.

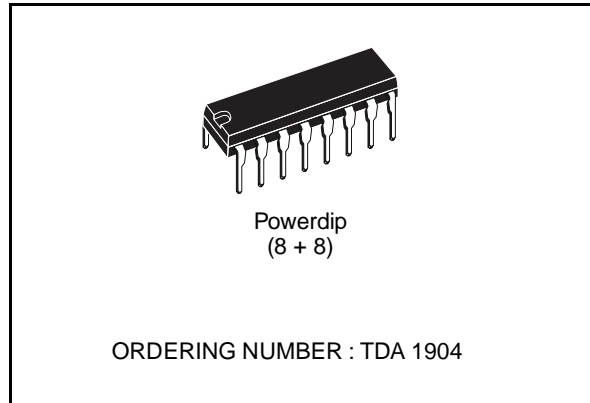

ABSOLUTE MAXIMUM RATINGS

Symbol	Parameter	Value	Unit
V_S	Supply voltage	20	V
I_O	Peak output current (non repetitive)	2.5	A
I_O	Peak output current (repetitive)	2	A
P_{tot}	Total power dissipation at $T_{amb} = 80^\circ\text{C}$	1	W
	at $T_{pins} = 60^\circ\text{C}$	6	W
T_{stg}, T_j	Storage and junction temperature	-40 to 150	$^\circ\text{C}$

TEST AND APPLICATION CIRCUIT

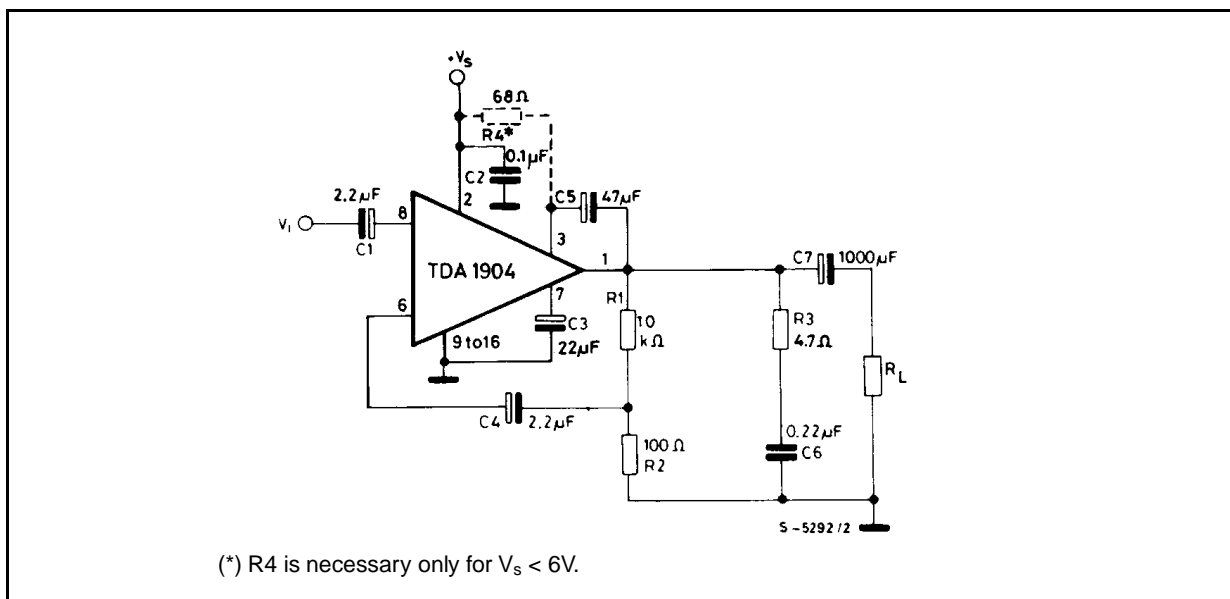

PIN CONNECTION

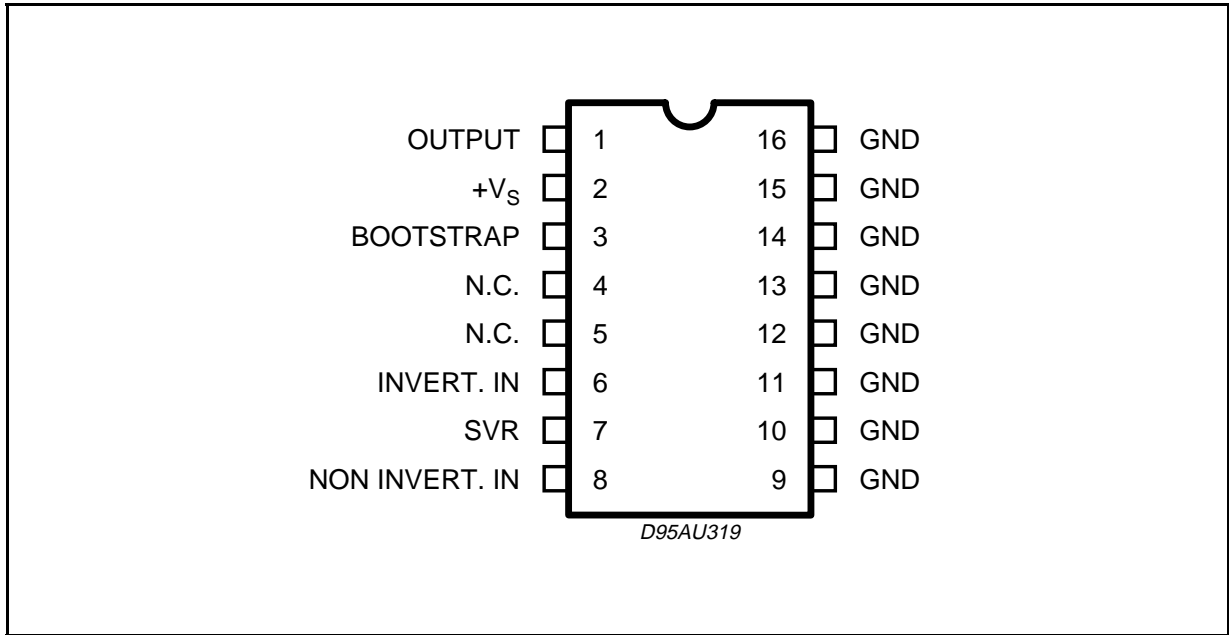

SCHEMATIC DIAGRAM

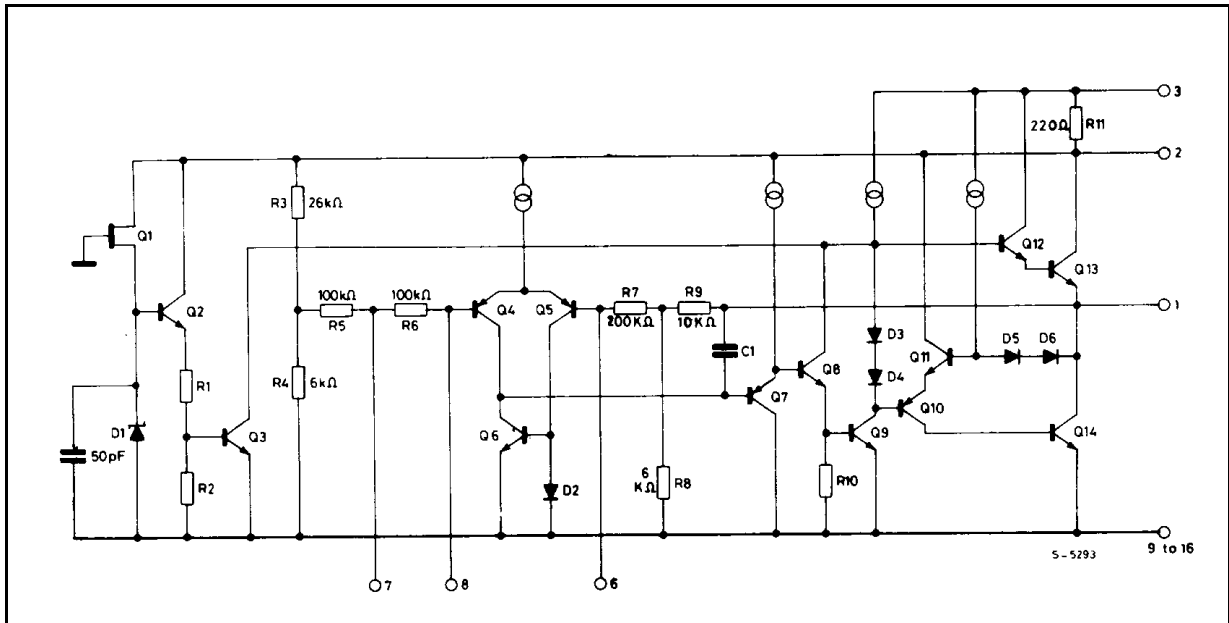

THERMAL DATA

Symbol	Parameter	Value	Unit
R _{thj-case}	Thermal resistance junction-pins	max 15	°C/W
R _{thj-amb}	Thermal resistance junction-ambient	max 70	°C/W

ELECTRICAL CHARACTERISTICS (Refer to the test circuit, $T_{amb} = 25\text{ }^{\circ}\text{C}$, R_{th} (heatsink) = $20\text{ }^{\circ}\text{C/W}$, unless otherwise specified)

Symbol	Parameter	Test conditions	Min.	Typ.	Max.	Unit
V_s	Supply voltage		4		20	V
V_o	Quiescent output voltage	$V_s = 4V$ $V_s = 14V$		2.1 7.2		V
I_d	Quiescent drain current	$V_s = 9V$ $V_s = 14V$		8 10	15 18	mA
P_o	Output power	$d = 10\%$ $f = 1\text{ KHz}$ $V_s = 9V$ $R_L = 4\Omega$ $V_s = 14V$ $V_s = 12V$ $V_s = 6V$	1.8 4 3.1 0.7	2 4.5		W
d	Harmonic distortion	$f = 1\text{ KHz}$ $V_s = 9V$ $R_L = 4\Omega$ $P_o = 50\text{ mW to }1.2W$		0.1	0.3	%
V_i	Input saturation voltage (rms)	$V_s = 9V$ $V_s = 14V$	0.8 1.3			V
R_i	Input resistance (pin 8)	$f = 1\text{ KHz}$	55	150		$K\Omega$
h	Efficiency	$f = 1\text{ KHz}$ $V_s = 9V$ $R_L = 4\Omega$ $P_o = 2W$ $V_s = 14V$ $R_L = 4\Omega$ $P_o = 4.5W$		70 65		%
BW	Small signal bandwidth (-3 dB)	$V_s = 14V$ $R_L = 4\Omega$	40 to 40,000			Hz
G_v	Voltage gain (open loop)	$V_s = 14V$ $f = 1\text{ KHz}$		75		dB
G_v	Voltage gain (closed loop)	$V_s = 14V$ $R_L = 4\Omega$ $f = 1\text{ KHz}$ $P_o = 1W$	39.5	40	40.5	dB
e_N	Total input noise	$R_g = 50\Omega$ $R_g = 10\text{ K}\Omega$ $(^{\circ})$		1.2 2	4	μV
		$R_g = 50\Omega$ $R_g = 10\text{ K}\Omega$ $(^{\circ\circ})$		2 3		μV
SVR	Supply voltage rejection	$V_s = 12V$ $f_{ripple} = 100\text{ Hz}$ $R_g = 10\text{ K}\Omega$ $V_{ripple} = 0.5\text{ V}_{rms}$	40	50		dB
T_{sd}	Thermal shut-down case temperature	$P_{tot} = 2W$		120		$^{\circ}\text{C}$

Note: $(^{\circ})$ Weighting filter = curve A.

$(^{\circ\circ})$ Filter with noise bandwidth: 22Hz to 22 KHz.

Figure 1. Test and application circuit

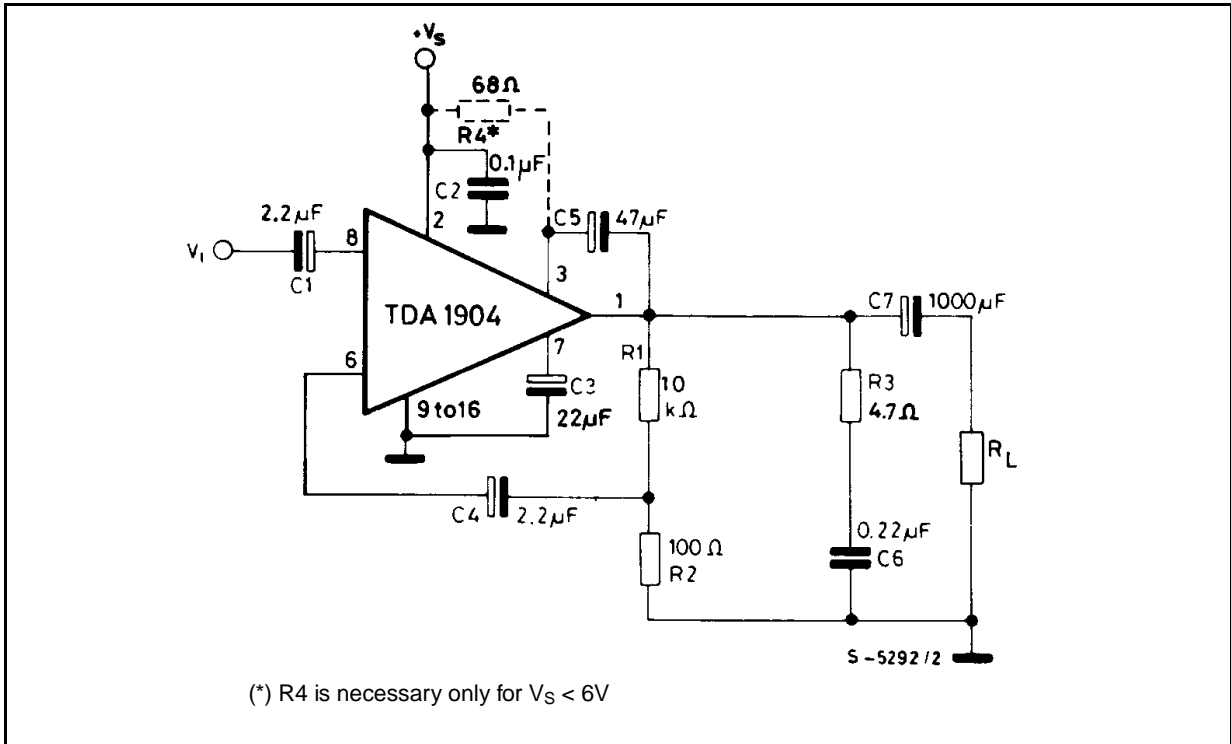
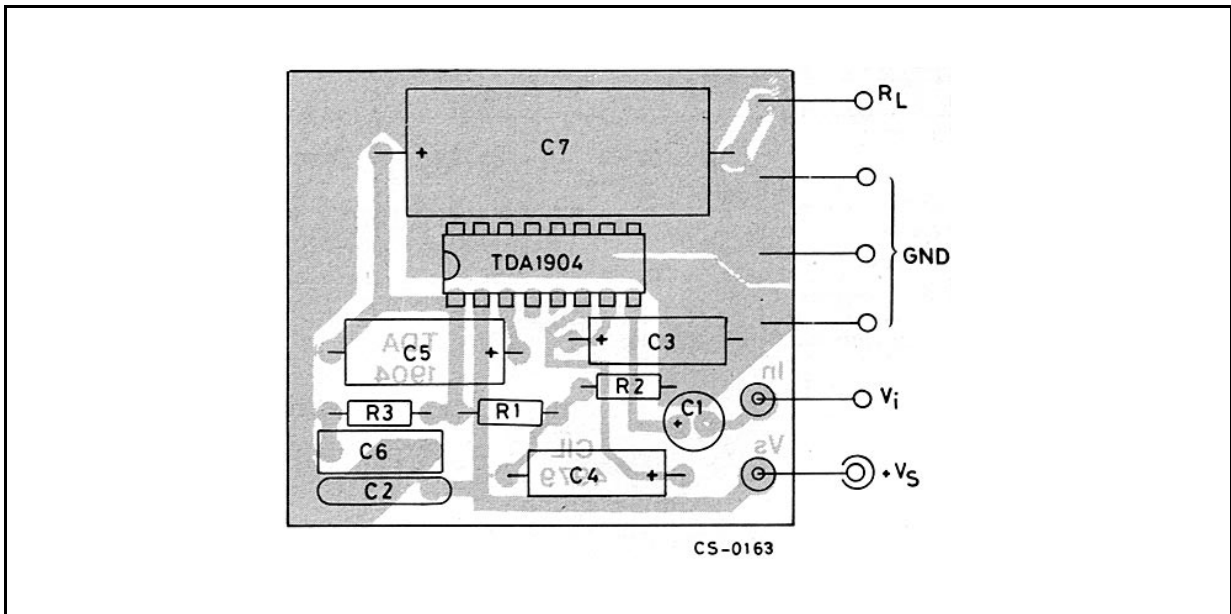

Figure 2. P.C. board and components layout of fig. 1 (1 : 1 scale)



APPLICATION SUGGESTION

The recommended values of the external components are those shown on the application circuit of fig. 1.

When the supply voltage V_S is less than 6V, a 68 Ω resistor must be connected between pin 2 and pin

3 in order to obtain the maximum output power.

Different values can be used. The following table can help the designer.

Components	Recomm. value	Purpose	Larger than recommended value	Smaller than recommended value	Allowed range	
					Min.	Max.
R1	10 K Ω	Feedback resistors	Increase of gain.	Decrease of gain. Increase quiescent current.	9R3	
R2	100 Ω		Decrease of gain.	Increase of gain.		1 K Ω
R3	4.7 Ω	Frequency stability	Danger of oscillation at high frequencies with inductive loads.			
R4	68 Ω	Increase of the output swing with low supply voltage.			39 Ω	220 Ω
C1	2.2 μ F	Input DC decoupling.	Higher cost lower noise.	Higher low frequency cutoff. Higher noise.		
C2	0.1 μ F	Supply voltage bypass.		Danger of oscillations.		
C3	22 μ F	Ripple rejection	Increase of SVR increase of the switch-on time.	Degradation of SVR.	2.2 μ F	100 μ F
C4	2.2 μ F	Inverting input DC decoupling.	Increase of the switch-on noise	Higher low frequency cutoff.	0.1 μ F	
C5	47 μ F	Bootstrap.		Increase of the distortion at low frequency.	10 μ F	100 μ F
C6	0.22 μ F	Frequency stability.		Danger of oscillation.		
C7	1000 μ F	Output DC decoupling		Higher low frequency cutoff.		

Figure 3. Quiescent output voltage vs. supply voltage

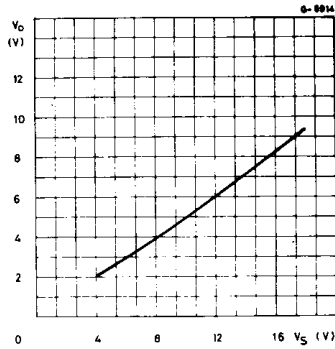

Figure 4. Quiescent drain current vs. supply voltage

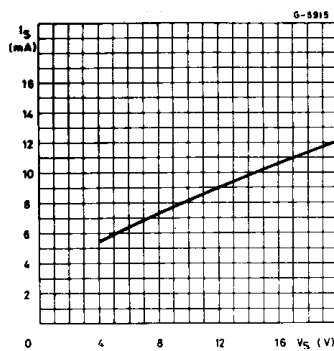

Figure 5. Output power vs. supply voltage

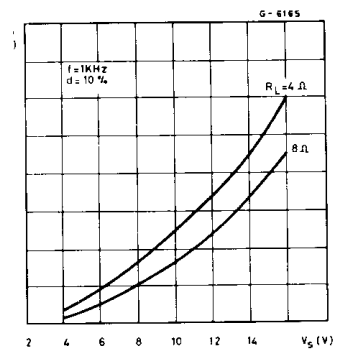

Figure 6. Distortion vs. output power

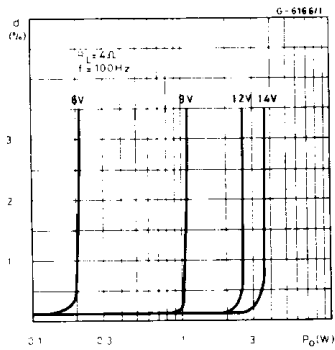

Figure 7. Distortion vs. output power

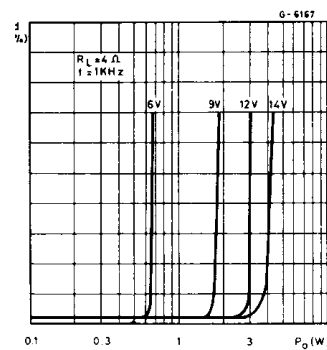

Figure 8. Distortion vs. output power

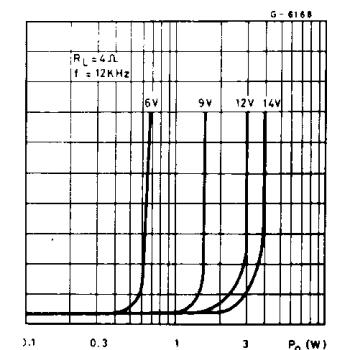

Figure 9. Distortion vs. output power

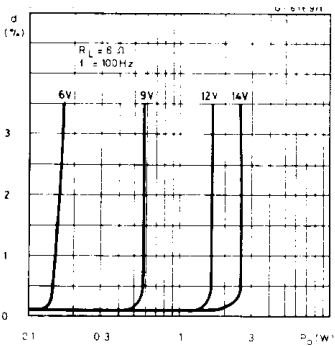

Figure 10. Distortion vs. output power

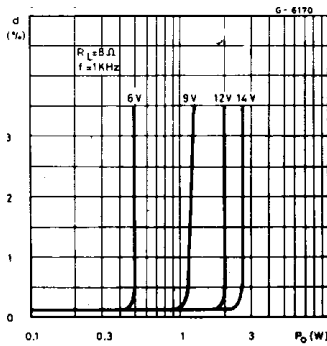

Figure 11. Distortion vs. output power

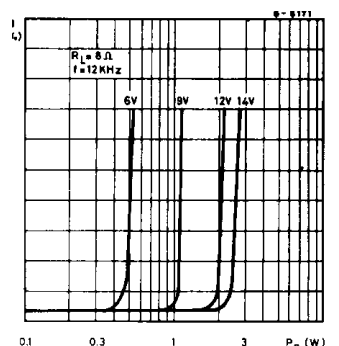

Figure 12. Distortion vs. frequency

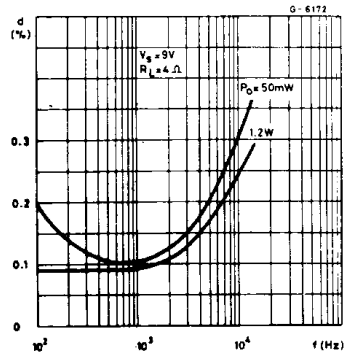

Figure 13. Distortion vs. frequency

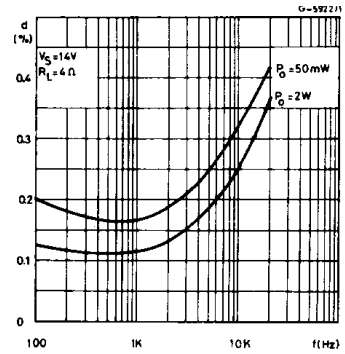

Figure 14. Distortion vs. frequency

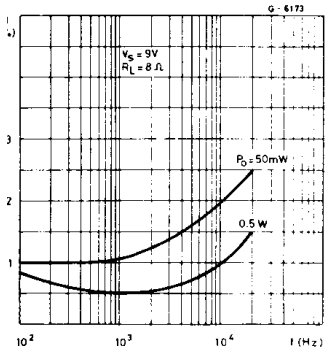

Figure 15. Distortion vs. frequency

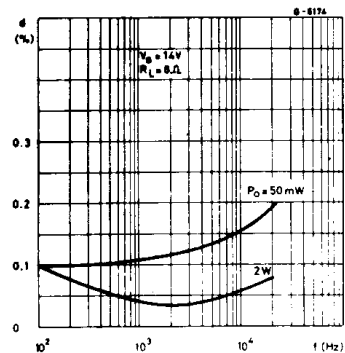

Figure 16. Supply voltage rejection vs. frequency

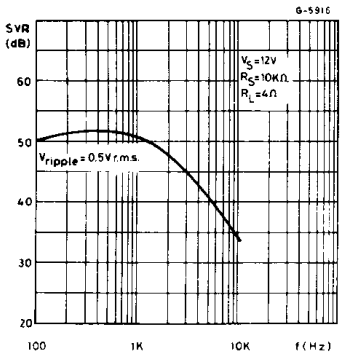

Figure 17. Total power dissipation and efficiency vs. output power

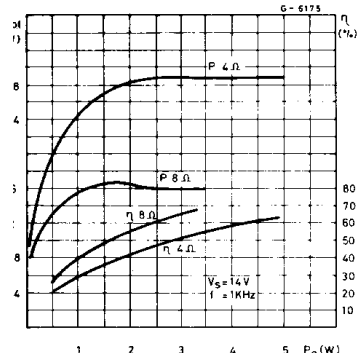

Figure 18. Total power dissipation and efficiency vs. output power

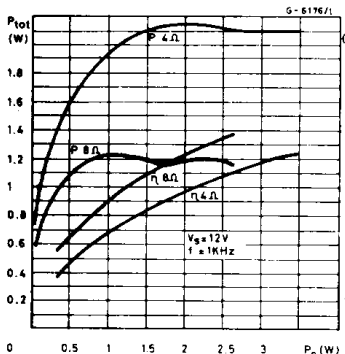

Figure 19. Total power dissipation and efficiency vs. output power

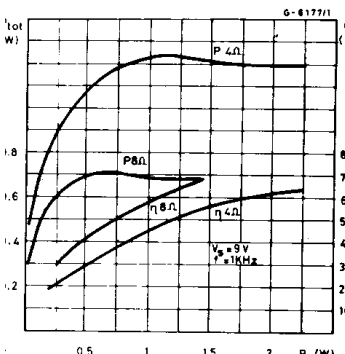
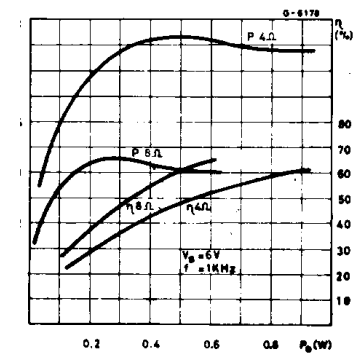

Figure 20. Total power dissipation and efficiency vs. output power



THERMAL SHUT-DOWN

The presence of a thermal limiting circuit offers the following advantages:

- 1) An overload on the output (even if it is permanent), or an above limit ambient temperature can be easily tolerated since the T_j cannot be higher than 150°C .
- 2) The heatsink can have a smaller factor of safety compared with that of a conventional circuit. There is no possibility of device damage due to high junction temperature. If for any reason, the junction temperature increase up to 150°C , the thermal shut-down simply reduces the power dissipation and the current consumption.

MOUNTING INSTRUCTION

The TDA 1904 is assembled in the Powerdip, in which 8 pins (from 9 to 16) are attached to the frame and remove the heat produced by the chip.

Figure 21 shows a PC board copper area used as a heatsink ($l = 65\text{ mm}$).

The thermal resistance junction-ambient is 35°C .

Figure 21. Example of heatsink using PC board copper ($l = 65\text{ mm}$)

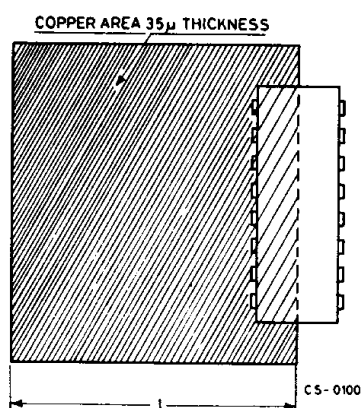

DIM.	mm			inch		
	MIN.	TYP.	MAX.	MIN.	TYP.	MAX.
a1	0.51			0.020		
B	0.85		1.40	0.033		0.055
b		0.50			0.020	
b1	0.38		0.50	0.015		0.020
D			20.0			0.787
E		8.80			0.346	
e		2.54			0.100	
e3		17.78			0.700	
F			7.10			0.280
I			5.10			0.201
L		3.30			0.130	
Z			1.27			0.050

OUTLINE AND MECHANICAL DATA

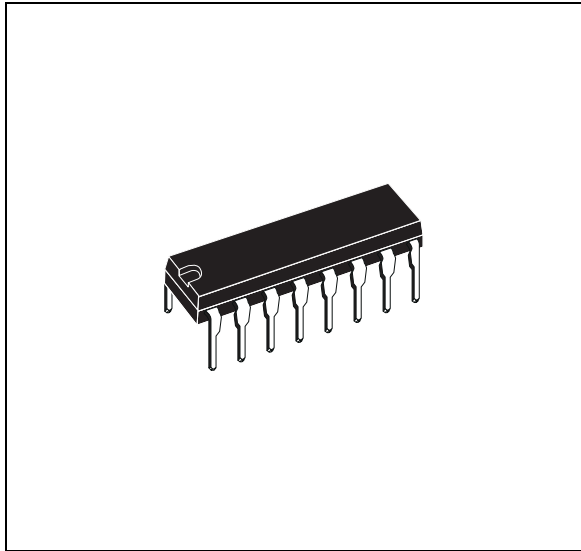

Powerdip 16

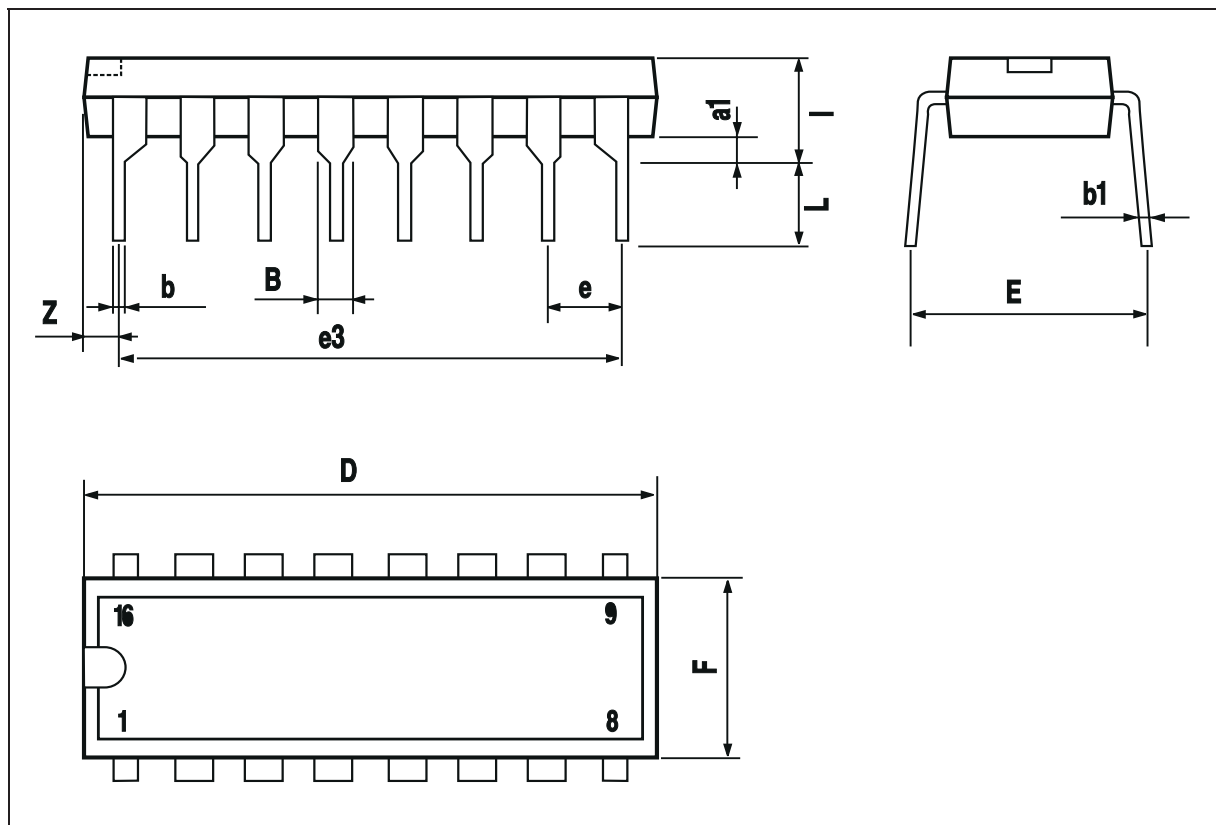

Information furnished is believed to be accurate and reliable. However, STMicroelectronics assumes no responsibility for the consequences of use of such information nor for any infringement of patents or other rights of third parties which may result from its use. No license is granted by implication or otherwise under any patent or patent rights of STMicroelectronics. Specifications mentioned in this publication are subject to change without notice. This publication supersedes and replaces all information previously supplied. STMicroelectronics products are not authorized for use as critical components in life support devices or systems without express written approval of STMicroelectronics.

The ST logo is a registered trademark of STMicroelectronics.
All other names are the property of their respective owners

© 2003 STMicroelectronics - All rights reserved

STMicroelectronics GROUP OF COMPANIES

Australia - Belgium - Brazil - Canada - China - Czech Republic - Finland - France - Germany - Hong Kong - India - Israel - Italy - Japan - Malaysia - Malta - Morocco - Singapore - Spain - Sweden - Switzerland - United Kingdom - United States

www.st.com