

15 V, 25 A unidirectional TVS in SOD882T

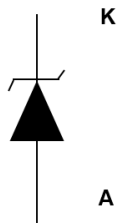
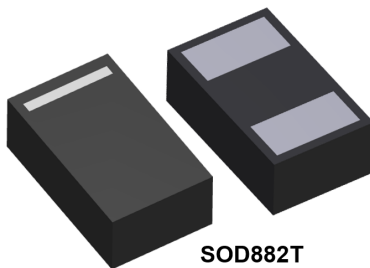

Unidirectional

Features

- Peak pulse power: 600 W (8/20 μ s)
- Stand-off voltage: 15 V
- Unidirectional type
- Low leakage current: 80 nA at 25 °C
- Operating T_j max: 150 °C
- Lead finishing: gold

Complies with the following standards

- IPC7531 footprint and JEDEC registered package outline
- IEC 61000-4-2, C = 150 pF - R = 330 Ω exceeds level 4:
 - 30 kV (contact discharge)
 - 30 kV (air discharge)

Description

The ESDA17P20-1F2 is a unidirectional single line TVS diode designed to protect the power line against EOS and ESD transients.

The device is ideal for applications where board space saving is required.

Product status link

[ESDA17P20-1F2](#)

1 Characteristics

Table 1. Absolute maximum ratings ($T_{amb} = 25\text{ }^{\circ}\text{C}$)

Symbol	Parameter		Value	Unit
V_{pp}	Peak pulse voltage	ISO10605 (C = 330 pF, R = 330 Ω)	30	kV
		contact discharge	30	
		air discharge		
P_{pp}	Peak pulse power (8/20 μs)		600	W
I_{pp}	Peak pulse current (8/20 μs)		25	A
T_{op}	Operating junction temperature range		-55 to 150	$^{\circ}\text{C}$
T_{stg}	Storage junction temperature range		-55 to 150	
T_L	Maximum lead temperature for soldering during 10 s		260	

Figure 1. Electrical characteristics (definitions)

- V_{RM} Maximum stand-off voltage
- I_{RM} Maximum leakage current @ V_{RM}
- V_R Stand-off voltage
- I_R Leakage current @ V_R
- V_{BR} Breakdown voltage @ I_{BR}
- I_{BR} Breakdown current
- V_{CL} Clamping voltage @ I_{pp}
- I_{pp} Peak pulse current
- R_D Dynamic resistance
- V_F Forward voltage drop @ I_F
- I_F Forward current
- αT Voltage temperature coefficient

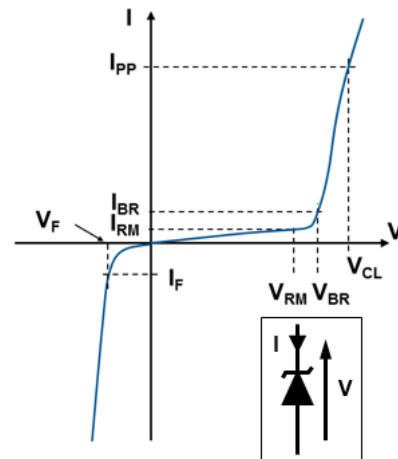
Table 2. Electrical characteristics (values) ($T_{amb} = 25\text{ }^{\circ}\text{C}$)

Symbol	Parameter	Test condition	Min.	Typ.	Max.	Unit
V_{RM}	Stand-off voltage				15	V
V_{BR}	Breakdown voltage	$I_R = 1\text{ mA}$	15.6	16.7	17.9	V
I_{RM}	Leakage current	$V_{RM} = 15\text{ V}$			80	nA
V_{CL}	Clamping voltage	$I_{pp} = 20\text{ A} - 8/20\text{ }\mu\text{s}$			23	V
		IEC 61000-4-2, 8 kV contact discharge measured at 30 ns		20.6		
R_D	Dynamic resistance, pulse	8/20 μs		0.25		Ω
C_{LINE}	Line capacitance	f = 1 MHz, $V_{LINE} = 0\text{ V}$, $V_{OSC} = 30\text{ mV}$		190		pF

1.1 Characteristics (curves)

Figure 2. Maximum peak power dissipation versus initial junction temperature

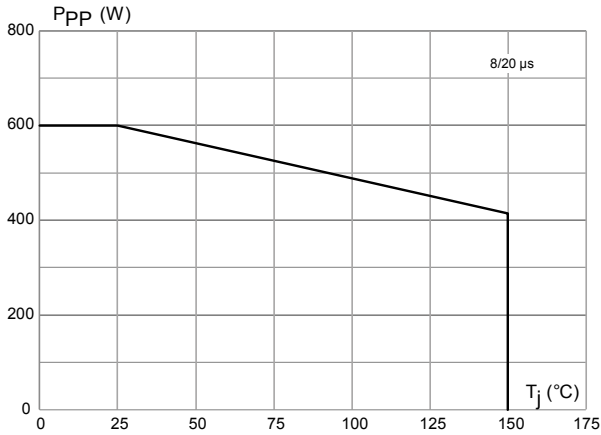

Figure 3. Maximum peak pulse power versus exponential pulse duration

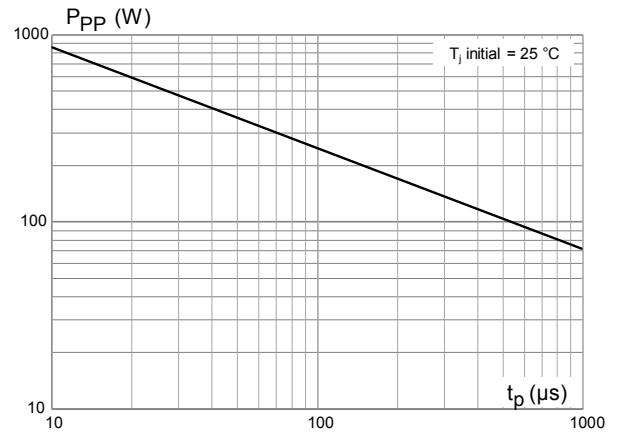

Figure 4. Maximum clamping voltage versus peak pulse current

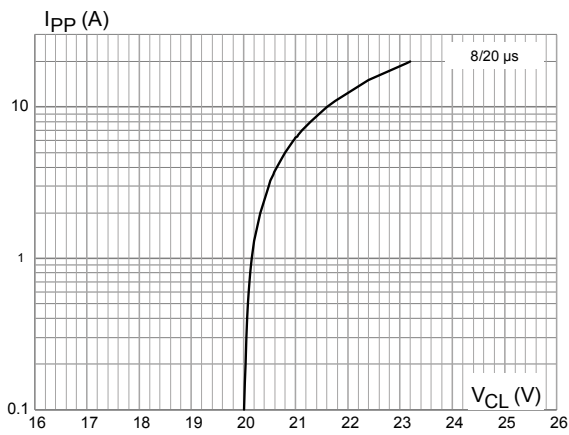

Figure 5. Leakage current versus junction temperature

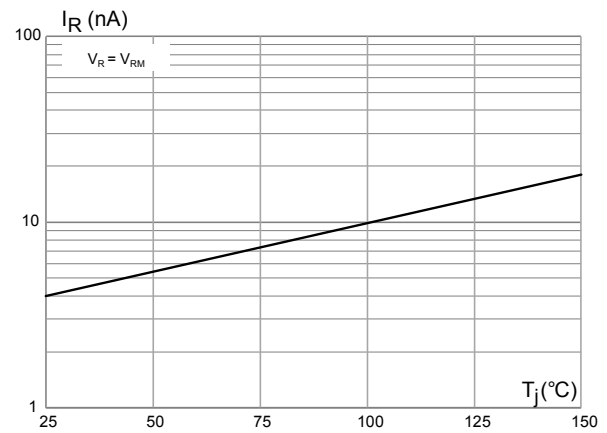

Figure 6. ESD response to IEC 61000-4-2 (-8 kV contact discharge)

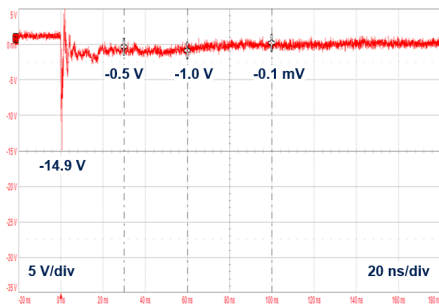
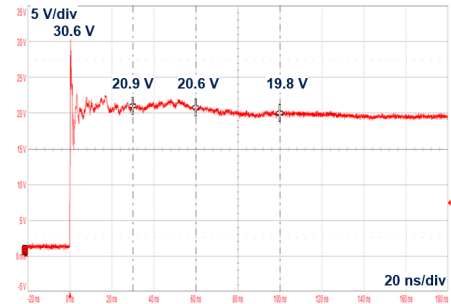

Figure 7. ESD response to IEC 61000-4-2 (+8 kV contact discharge)



2 Package information

In order to meet environmental requirements, ST offers these devices in different grades of **ECOPACK** packages, depending on their level of environmental compliance. ECOPACK specifications, grade definitions and product status are available at: www.st.com. ECOPACK is an ST trademark.

2.1 SOD882T package information

Figure 8. SOD882T package outline

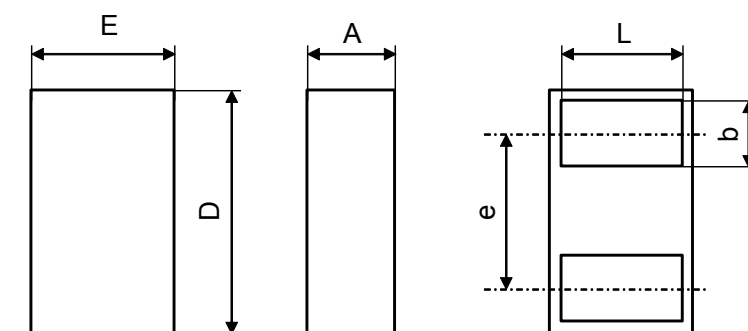

Table 3. SOD882T mechanical data

Ref.	Dimensions		
	Millimeters		
	Min.	Typ.	Max.
A	0.330	0.350	0.370
b	0.230	0.250	0.270
D	0.970	1.000	1.030
E	0.570	0.600	0.630
e		0.650	
L	0.480	0.500	0.520

Figure 9. Recommended footprint (mm)

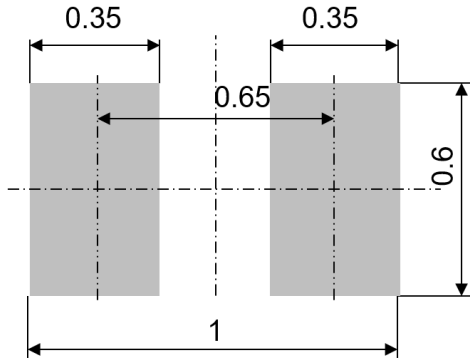
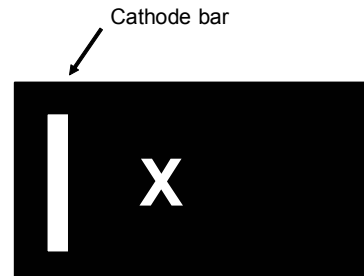
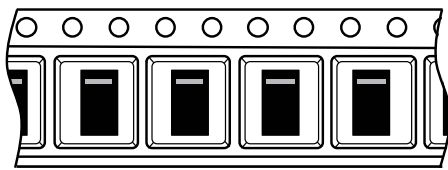

Figure 10. Marking



X : refer to ordering table for marking

Figure 11. Package orientation in reel



Taped according to EIA-481

Note: Pocket dimensions are not on scale
Pocket shape may vary depending on package
On bidirectional devices, marking and logo may be not always in the same direction

Figure 12. Tape and reel orientation

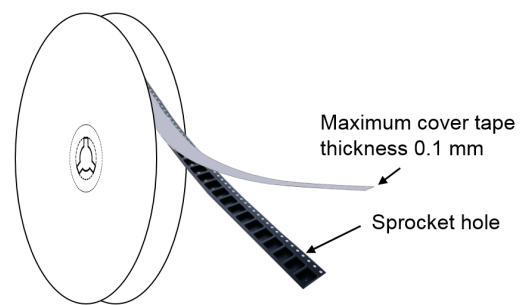

Figure 13. Reel dimension values (mm)

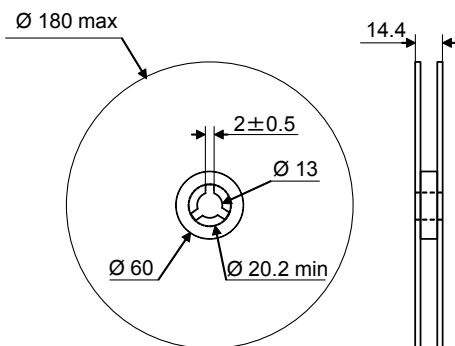

Figure 14. Inner box dimension values (mm)

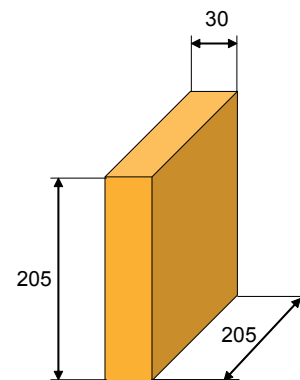
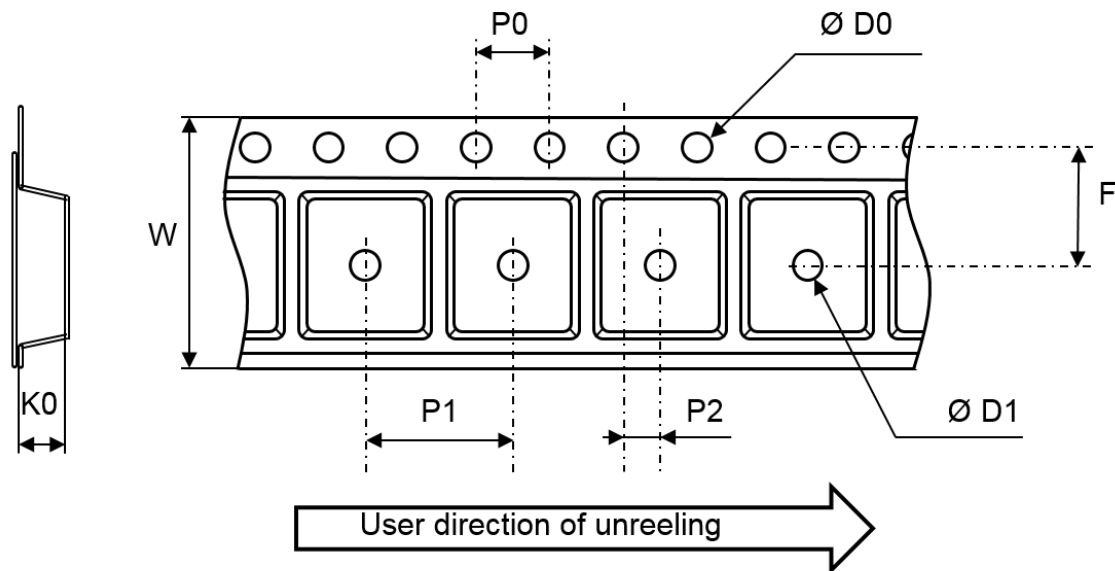

Figure 15. Tape outline



Note: Pocket dimensions are not on scale
Pocket shape may vary depending on package

Table 4. Tape dimension values

Ref.	Dimensions		
	Millimeters		
	Min.	Typ.	Max.
D0	1.5	1.55	1.6
D1	0.195	0.2	0.205
F	3.45	3.5	3.55
K0	0.39	0.42	0.45
P0	3.9	4.0	4.1
P1	1.95	2.0	2.05
P2	1.95	2.0	2.05
W	7.9	8.0	8.3

3 PCB assembly recommendations

3.1 Recommended stencil opening

Figure 16. Recommended stencil opening (mm)

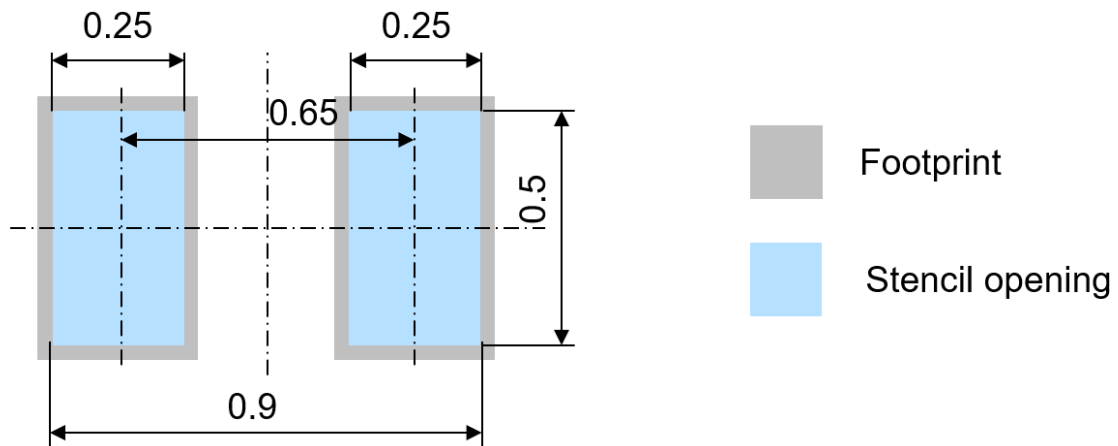

Stencil opening thickness: 100 μ m

3.2 Solder paste

1. Halide-free flux qualification ROL0 according to ANSI/J-STD-004.
2. "No clean" solder paste is recommended.
3. Offers a high tack force to resist component movement during high speed.
4. Use solder paste with fine particles: powder particle size 20-38 μ m.

3.3 Reflow profile

Figure 17. ST ECOPACK[®] recommended soldering reflow profile for PCB mounting

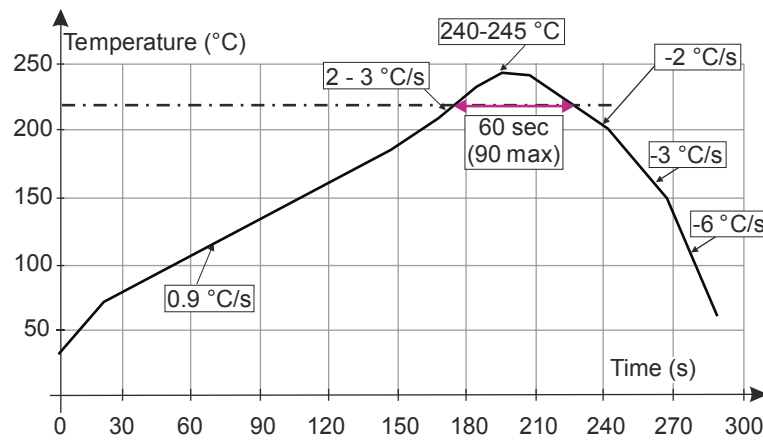

Note: Minimize air convection currents in the reflow oven to avoid component movement. Maximum soldering profile corresponds to the latest IPC/JEDEC J-STD-020.

4 Ordering information

Table 5. Ordering information

Order code	Marking	Package	Weight	Base qty.	Delivery mode
ESDA17P20-1F2	A	SOD882T	0.54 mg	10000	Tape and reel

Revision history

Table 6. Document revision history

Date	Version	Changes
15-Jun-2020	1	Initial release.

IMPORTANT NOTICE – PLEASE READ CAREFULLY

STMicroelectronics NV and its subsidiaries (“ST”) reserve the right to make changes, corrections, enhancements, modifications, and improvements to ST products and/or to this document at any time without notice. Purchasers should obtain the latest relevant information on ST products before placing orders. ST products are sold pursuant to ST’s terms and conditions of sale in place at the time of order acknowledgement.

Purchasers are solely responsible for the choice, selection, and use of ST products and ST assumes no liability for application assistance or the design of Purchasers’ products.

No license, express or implied, to any intellectual property right is granted by ST herein.

Resale of ST products with provisions different from the information set forth herein shall void any warranty granted by ST for such product.

ST and the ST logo are trademarks of ST. For additional information about ST trademarks, please refer to www.st.com/trademarks. All other product or service names are the property of their respective owners.

Information in this document supersedes and replaces information previously supplied in any prior versions of this document.

© 2020 STMicroelectronics – All rights reserved