

Automotive common mode filter with ESD protection

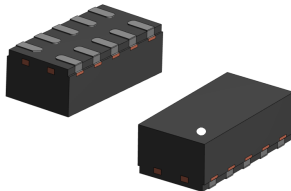

QFN-10L 2.6 x 1.35 x 0.75

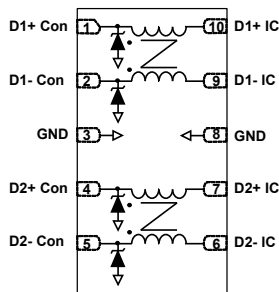

Product status link

[ECMF04-4HSM10Y](#)

Product summary

Order code	ECMF04-4HSM10Y
------------	----------------

Features

- AEC-Q101 qualified 
- 2.2 GHz differential bandwidth to comply with HDMI 1.4, USB 3.1, MIPI, display port
- Common mode attenuation on LTE, GSM, and GPS frequencies:
 - -20 dB at 0.7 GHz
 - -25 dB from 0.8 to 0.9 GHz
 - -14 dB at 1.5 GHz
- Wettable flank for automatic optical inspection
- Low PCB space consumption: 3.5 mm²
- Thin package for compact applications: 0.75 mm
- RoHS package

Complies with the following standards

- UL94, V0
- J-STD-020 MSL level 1
- J-STD-002
- IPC7531 footprint and JEDEC registered package
- ISO 10605, IEC 61000-4-2, C = 150 pF – R = 330 Ω level 4:
 - 8 kV (contact discharge)
 - 15 kV (air discharge)
- ISO 10605, C = 330 pF – R = 330 Ω level 4:
 - 8 kV (contact discharge)
 - 15 kV (air discharge)

Description

The **ECMF04-4HSM10Y** is an integrated common mode filter designed to suppress EMI/RFI common mode noise on high speed buses HDMI 1.4, USB 3.1 and MIPI. It is designed to replace discrete common mode chokes or LTCC.

The device embeds ESD protections on connector side to meets ISO 10605 requirements.

Packaged in QFN-10L with wettable flank, it is compatible with automatic visual inspection.

1 Characteristics

Table 1. Absolute maximum ratings ($T_{amb} = 25\text{ °C}$)

Symbol	Parameter	Value	Unit	
V_{PP}	Peak pulse voltage	ISO 10605 (C = 330 pF, R = 330 Ω):		
		Contact discharge	8	kV
		Air discharge	15	
		ISO10605 / IEC 61000-4-2 (C = 150 pF, R = 330 Ω):		
	Contact discharge	8		
	Air discharge	15		
I_{RMS}	RMS current	100	mA	
T_{op}	Operating ambient temperature range	-55 to +125	°C	
T_{stg}	Storage temperature range	-55 to +150		

Figure 1. Electrical characteristics (definitions)

- V_{RM} Maximum stand-off voltage
- V_{CL} Clamping voltage at peak pulse current I_{PP}
- I_{RM} Leakage current at V_{RM}
- I_{PP} Peak pulse current
- V_{BR} Breakdown voltage
- R_{DC} DC serial resistance
- f_c Differential cut off frequency

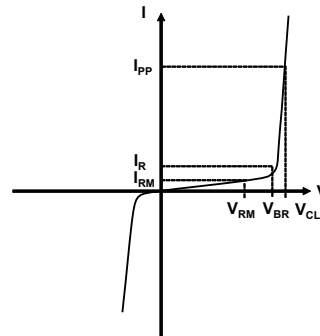

Table 2. Electrical characteristics ($T_{amb} = 25\text{ °C}$)

Symbol	Test conditions	Min.	Typ.	Max.	Unit
V_{BR}	$I_R = 1\text{ mA}$	6	7		V
I_{RM}	$V_{RM} = 3\text{ V}$			100	nA
R_{DC}	$I_{DC} = 20\text{ mA}$		5.5		Ω
f_c	$S_{DD21} = -3\text{ dB}$		2.2		GHz
V_{CL}	8 kV contact discharge after 30 ns, ISO 10605 (150 pF – 330 Ω)		27		V

1.1 Characteristics (curves)

Figure 2. Differential attenuation versus frequency
($Z_{0_diff} = 100 \Omega$)

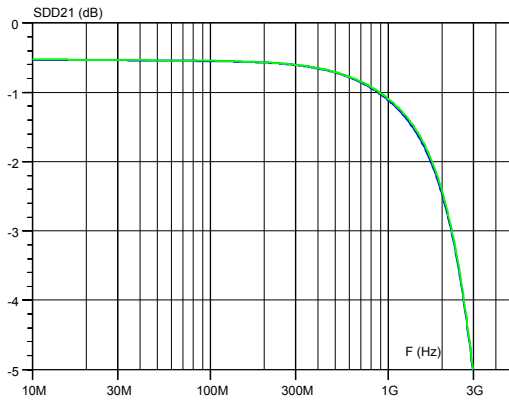

Figure 3. Common mode attenuation versus frequency
($Z_{0_com} = 50 \Omega$)

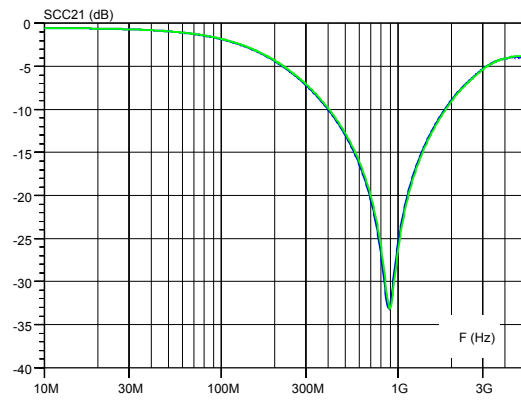

Figure 4. ISO 10605 - C = 150 pF, R = 330 Ω (+8 kV contact)

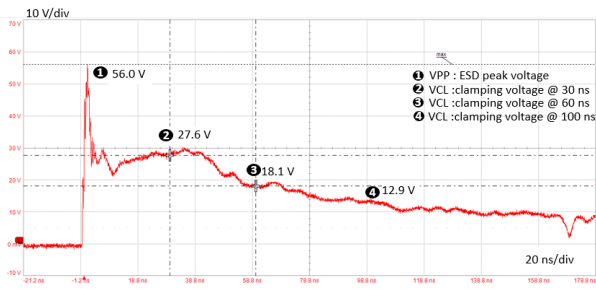

Figure 5. ISO 10605 - C = 150 pF, R = 330 Ω (-8 kV contact)

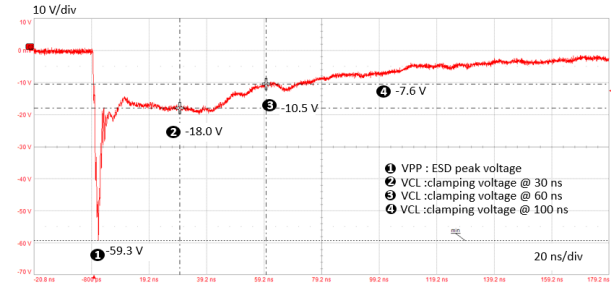

Figure 6. TLP characteristic

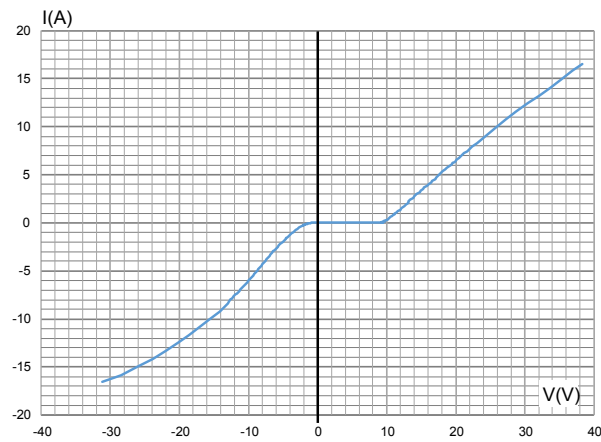

Figure 7. HDMI1.4 – 1.485 Gbps eye diagram without device

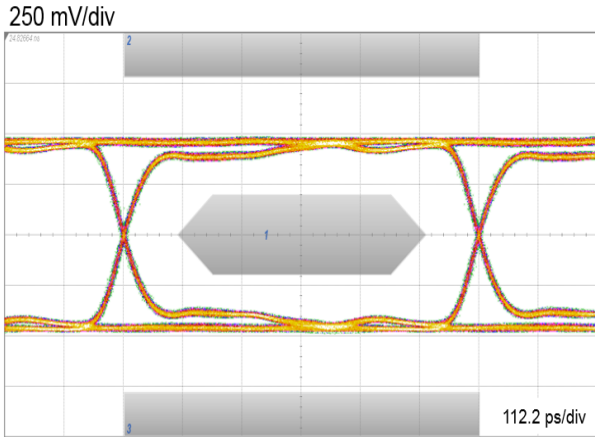

Figure 8. HDMI1.4 – 1.485 Gbps eye diagram with device

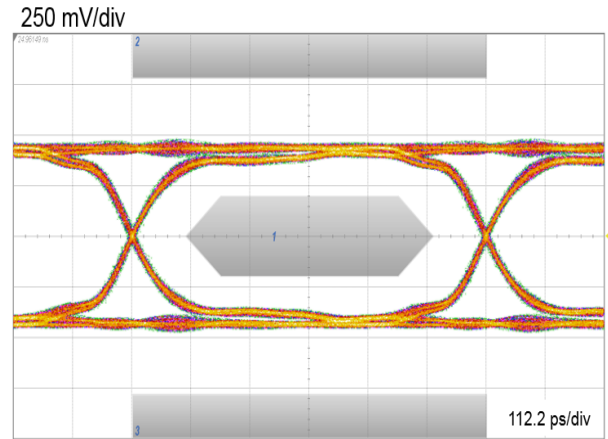

Figure 9. MIPI - 5.83 Gbps eye diagram without device

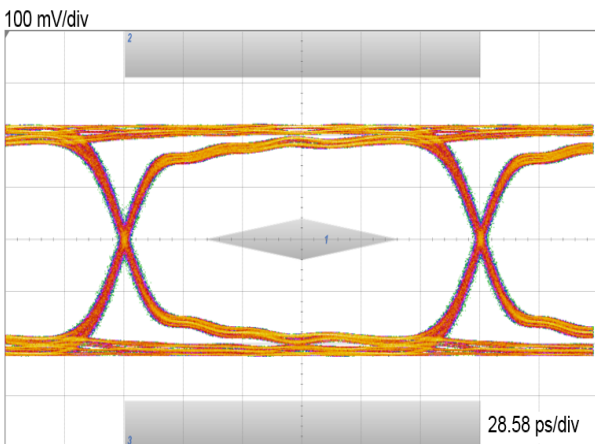

Figure 10. MIPI - 5.83 Gbps eye diagram with device

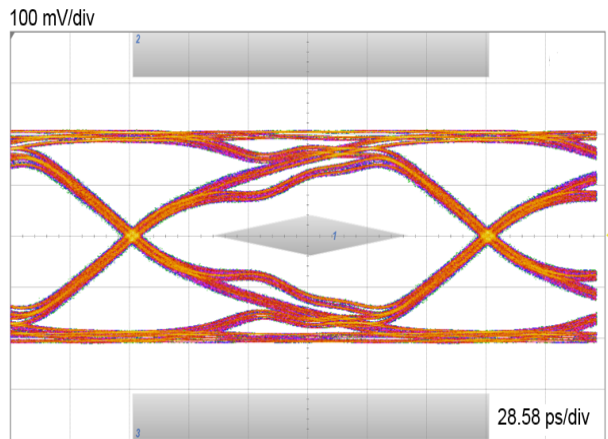

Figure 11. USB3.1 – 5 Gbps eye diagram without device (with worst cable and equalizer)

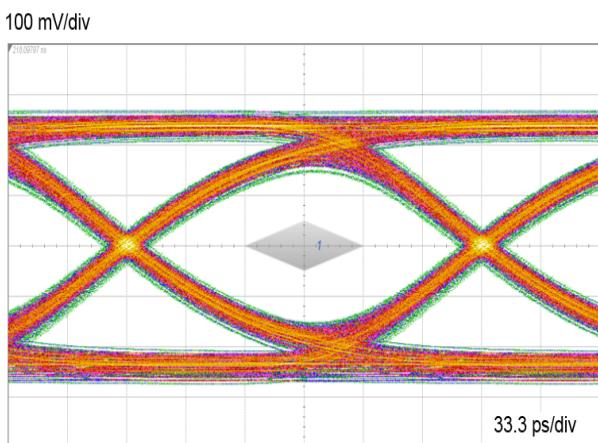
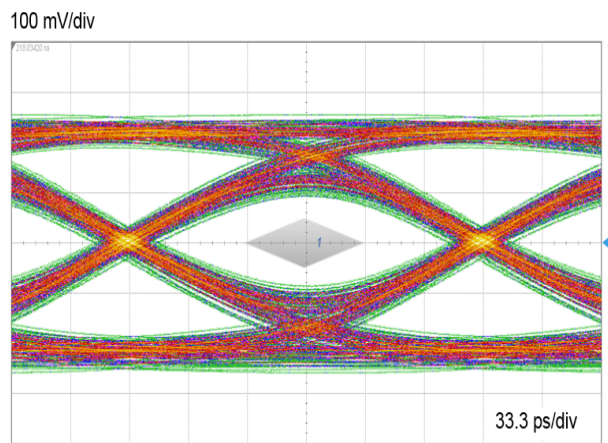

Figure 12. USB3.1 – 5 Gbps eye diagram with device (with worst cable and equalizer)



2 Package information

In order to meet environmental requirements, ST offers these devices in different grades of **ECOPACK** packages, depending on their level of environmental compliance. ECOPACK specifications, grade definitions and product status are available at: www.st.com. ECOPACK is an ST trademark.

2.1 QFN-10L package information

Figure 13. QFN-10L package outline

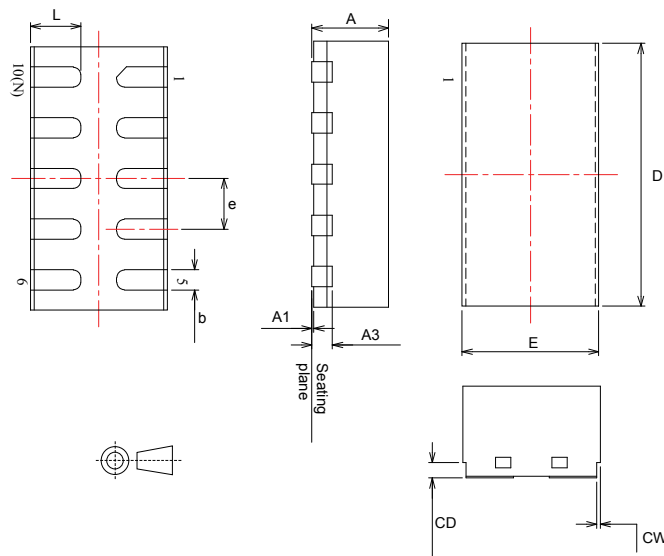

Table 3. QFN-10L mechanical data

Ref.	Dimensions					
	Millimeters			Inches ⁽¹⁾		
	Min.	Typ.	Max.	Min.	Typ.	Max.
A	0.70	0.75	0.80	0.0275	0.0295	0.0315
A1	0.00	0.02	0.05	0.0000	0.0008	0.0020
A3		0.20			0.0079	
b	0.15	0.20	0.25	0.0059	0.0079	0.0099
D	2.55	2.60	2.65	0.1003	0.1024	0.1044
E	1.30	1.35	1.40	0.0511	0.0531	0.0552
e		0.50			0.0197	
L	0.45	0.50	0.55	0.0177	0.0197	0.0217
CW	0.01	0.05	0.09	0.0003	0.0020	0.0032
CD	0.10			0.0039		

1. Value in inches are converted from mm and rounded to 4 decimal digits

3 PCB assembly recommendation

Figure 14. Recommended PCB layout

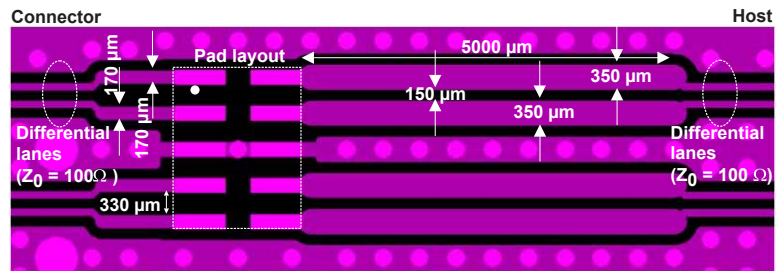

Figure 15. Recommended PCB stack-up

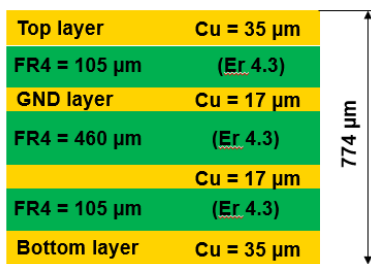

Figure 16. Recommended stencil opening (mm)

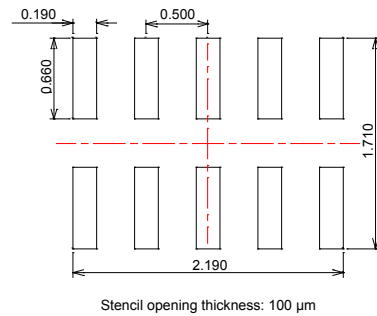

Figure 17. Wettable flank profile



3.1 Solder paste

1. Halide-free flux qualification ROL0 according to ANSI/J-STD-004.
2. "No clean" solder paste is recommended.
3. Offers a high tack force to resist component movement during high speed.
4. Use solder paste with fine particles: powder particle size is 20-38 μm .

3.2 QFN-10L packing information

Figure 18. Footprint recommendations (mm)

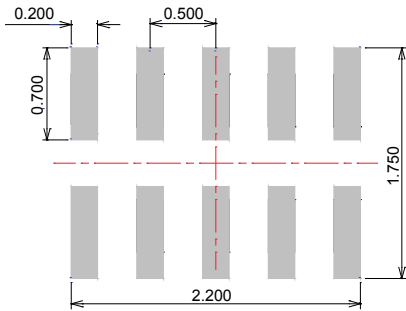
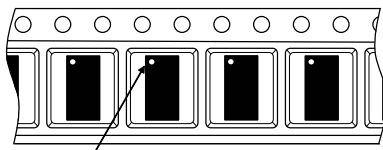

Figure 19. Marking



Dot indicates pin 1
XX: Marking
Y: Year
M: Month

Figure 20. Package orientation in reel



Pin 1 located according to EIA-481

Note: Pocket dimensions are not on scale
Pocket shape may vary depending on package

Figure 21. Tape and reel orientation

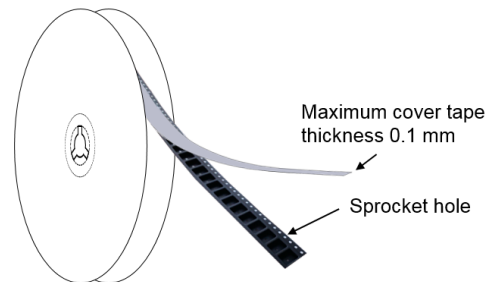

Figure 22. Reel dimensions (mm)

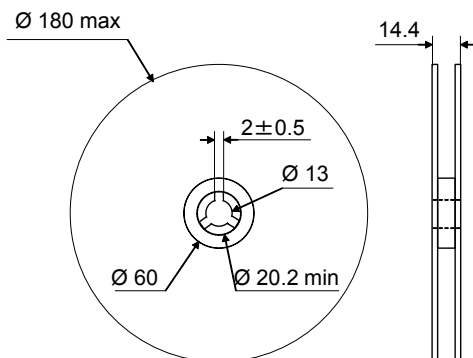

Figure 23. Inner box dimensions (mm)

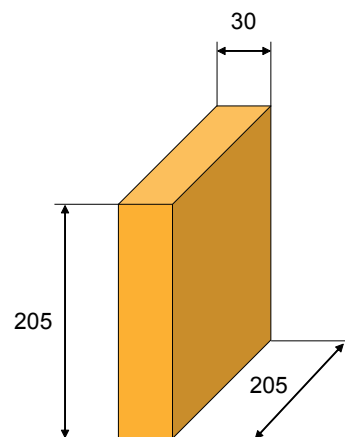
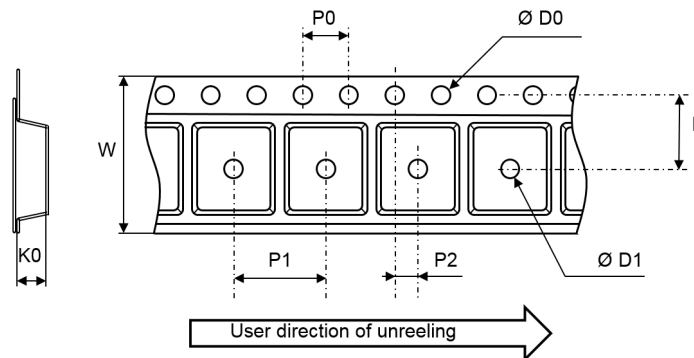

Figure 24. Tape and reel outline

Note: Pocket dimensions are not on scale
Pocket shape may vary depending on package

Table 4. Tape and reel mechanical data

Ref.	Dimensions		
	Millimeters		
	Min.	Typ.	Max.
ØD0	1.40	1.50	1.50
ØD1	0.80		
F	1.65	1.75	1.85
K0	0.85	0.95	1.05
P0	3.9	4.0	4.1
P1	3.9	4.0	4.1
P2	1.95	2.00	2.05
W	7.9	8.0	8.3

3.3 Solder reflow

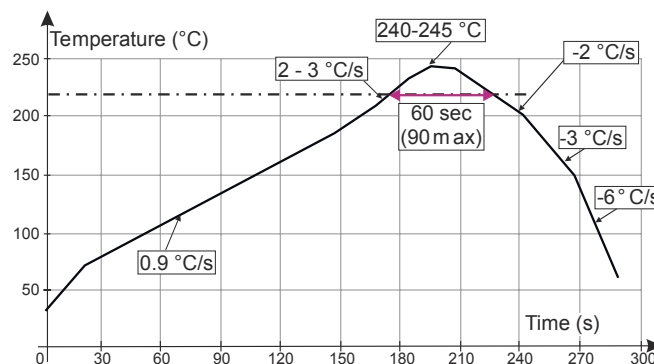
Figure 25. ST ECOPACK® recommended soldering reflow profile for PCB mounting

Note: Minimize air convection currents in the reflow oven to avoid component movement. Maximum soldering profile corresponds to the latest IPC/JEDEC J-STD-020.

4 Ordering information

Order code	Marking	Package	Weight	Base qty.	Delivery mode
ECMF04-4HSM10Y	AY ⁽¹⁾	QFN-10L	7 mg	3000	Tape and reel

1. The marking can be rotated by 90° to differentiate assembly location

Revision history

Table 5. Document revision history

Date	Version	Changes
06-Sep-2018	1	Initial release.
09-Dec-2019	2	Added Stencil opening design and Section 3.1 .

IMPORTANT NOTICE – PLEASE READ CAREFULLY

STMicroelectronics NV and its subsidiaries (“ST”) reserve the right to make changes, corrections, enhancements, modifications, and improvements to ST products and/or to this document at any time without notice. Purchasers should obtain the latest relevant information on ST products before placing orders. ST products are sold pursuant to ST’s terms and conditions of sale in place at the time of order acknowledgement.

Purchasers are solely responsible for the choice, selection, and use of ST products and ST assumes no liability for application assistance or the design of Purchasers’ products.

No license, express or implied, to any intellectual property right is granted by ST herein.

Resale of ST products with provisions different from the information set forth herein shall void any warranty granted by ST for such product.

ST and the ST logo are trademarks of ST. For additional information about ST trademarks, please refer to www.st.com/trademarks. All other product or service names are the property of their respective owners.

Information in this document supersedes and replaces information previously supplied in any prior versions of this document.

© 2019 STMicroelectronics – All rights reserved