

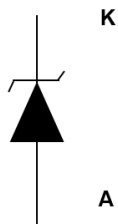

Automotive 400 W TVS in SMA Flat

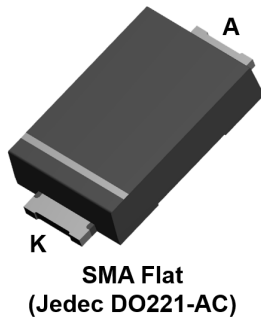

Unidirectional

Features

- AEC-Q101 qualified 
- Peak pulse power: 400 W (10/1000 μ s) and 2.5 kW (8/20 μ s)
- Stand-off voltage range from 5 V to 188 V
- Unidirectional type
- Low leakage current: 0.2 μ A at 25 °C and 1 μ A at 85 °C
- Operating T_j max: 175 °C
- High power capability at T_j max.: up to 200 W (10/1000 μ s)
- Lead finishing: matte tin plating

Complies with the following standards

- UL94, V0
- J-STD-020 MSL level 1
- J-STD-002, JESD 22-B102 E3 and MIL-STD-750, method 2026
- JESD-201 class 2 whisker test
- IPC7531 footprint and JEDEC registered package outline
- ISO10605, IEC 61000-4-2, C = 150 pF - R = 330 Ω exceeds level 4:
 - 25 kV (contact discharge)
 - 30 kV (air discharge)
- ISO10605, C = 330 pF, R = 330 Ω exceeds level 4:
 - 25 kV (contact discharge)
 - 30 kV (air discharge)
- ISO7637-2 (Not applicable to parts with V_{RM} lower than battery voltage)
 - Pulse 1: $V_S = -150$ V
 - Pulse 2a: $V_S = +112$ V
 - Pulse 3a: $V_S = -220$ V
 - Pulse 3b: $V_S = +150$ V

Description

The SMA4FY Transil series are designed to protect sensitive automotive circuits against surges defined in ISO 7637 series and against electrostatic discharges according to ISO 10605.

The Planar technology makes it compatible with high-end circuits where low leakage current and high junction temperature are required to provide long term reliability and stability.

Product status link

SM4FY	SMA4F5.0AY , SMA4F6.0AY , SMA4F6.5AY , SMA4F8.5AY , SMA4F10AY , SMA4F11AY , SMA4F12AY , SMA4F13AY , SMA4F14AY , SMA4F15AY , SMA4F16AY , SMA4F18AY , SMA4F20AY , SMA4F22AY , SMA4F23AY , SMA4F24AY , SMA4F26AY , SMA4F28AY , SMA4F30AY , SMA4F31AY , SMA4F33AY , SMA4F36AY , SMA4F40AY , SMA4F48AY , SMA4F58AY , SMA4F70AY , SMA4F85AY , SMA4F100AY , SMA4F130AY , SMA4F154AY , SMA4F170AY , SMA4F188AY
-------	---

1 Characteristics

Table 1. Absolute maximum ratings ($T_{amb} = 25\text{ }^{\circ}\text{C}$)

Symbol	Parameter	Value	Unit	
V_{PP}	Peak pulse voltage	ISO10605 (C = 330 pF, R = 330 Ω):		
		Contact discharge	25	kV
		Air discharge	30	
		ISO10605 / IEC 61000-4-2 (C = 150 pF, R = 330 Ω)		
Contact discharge	25			
	Air discharge	30		
P_{PP}	Peak pulse power dissipation	10/1000 μs , T_j initial = T_{amb}	400	W
T_{stg}	Storage temperature range		-65 to +175	$^{\circ}\text{C}$
T_j	Operating junction temperature range		-55 to +175	$^{\circ}\text{C}$
T_L	Maximum lead temperature for soldering during 10 s		260	$^{\circ}\text{C}$

Figure 1. Electrical characteristics - parameter definitions

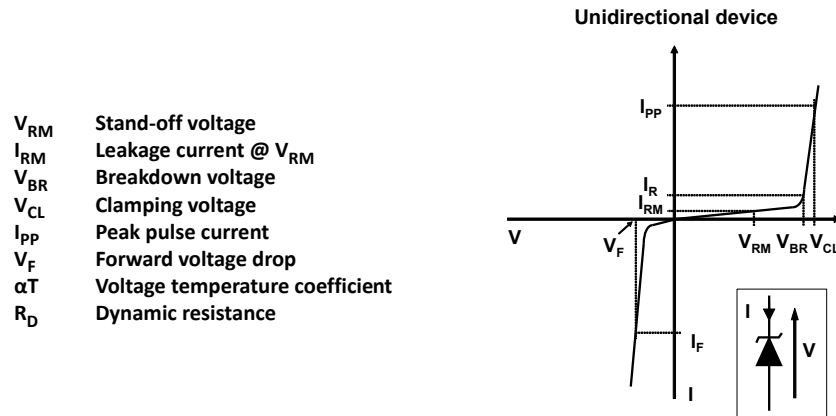

Figure 2. Pulse definition for electrical characteristics

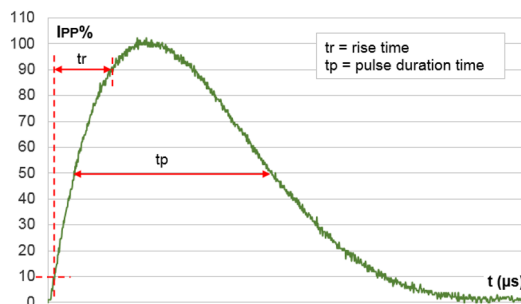

Table 2. Electrical characteristics - parameter values ($T_{amb} = 25\text{ }^{\circ}\text{C}$, unless otherwise specified)

Type	I_{RM} max at V_{RM}			V_{BR} at I_R				10 / 1000 μs			8 / 20 μs			$\alpha T^{(1)(2)}$
								$V_{CL}^{(3)}$	I_{PP}	R_D	$V_{CL}^{(3)}$	I_{PP}	R_D	Max.
	25 $^{\circ}\text{C}$	85 $^{\circ}\text{C}$		Min.	Typ.	Max.		Max.		Max.		Max.		
	μA	V		V			mA	V	A ⁽⁴⁾	Ω	V	A ⁽⁴⁾	Ω	$10^{-4}/^{\circ}\text{C}$
SMA4F5.0AY	20	50	5.0	6.4	6.74	7.1	10	9.2	43.5	0.048	13.4	174	0.036	5.7
SMA4F6.0AY	20	50	6.0	6.7	7.05	7.4	10	10.3	38.8	0.075	13.7	170	0.037	5.9
SMA4F6.5AY	20	50	6.5	7.2	7.58	8	10	11.2	35.7	0.09	14.5	160	0.041	6.1
SMA4F8.5AY	20	50	8.5	9.4	9.9	10.4	1	14.4	27.7	0.144	19.5	124	0.073	7.3
SMA4F10AY	0.2	1	10	11.1	11.7	12.3	1	17	23.5	0.2	21.7	106	0.089	7.8
SMA4F11AY	0.2	1	11	12.3	13	13.7	1	18	21.8	0.216	24.2	96	0.11	8.1
SMA4F12AY	0.2	1	12	13.3	14	14.7	1	19.9	20.1	0.259	25.3	91	0.116	8.3
SMA4F13AY	0.2	1	13	14.4	15.2	16	1	21.5	18.6	0.296	27.2	85	0.132	8.4
SMA4F14AY	0.2	1	14	15.7	16.5	17.3	1	23.1	17.2	0.337	29	79	0.148	8.6
SMA4F15AY	0.2	1	15	16.7	17.6	18.5	1	24.4	16.4	0.36	32.5	71	0.197	8.8
SMA4F16AY	0.2	1	16	17.9	18.8	19.8	1	26	15.4	0.403	34.7	67	0.222	9.0
SMA4F18AY	0.2	1	18	20	21.1	22.2	1	29.2	13.7	0.511	39.3	59	0.29	9.2
SMA4F20AY	0.2	1	20	22.2	23.4	24.6	1	32.4	12.3	0.634	42.8	54	0.337	9.4
SMA4F22AY	0.2	1	22	24.4	25.7	27	1	35.5	11.2	0.759	48.3	48	0.444	9.6
SMA4F23AY	0.2	1	23	25.7	27	28.4	1	37.8	10.6	0.888	49.2	47	0.444	9.6
SMA4F24AY	0.2	1	24	26.7	28.1	29.5	1	38.9	10.3	0.913	50	46	0.446	9.6
SMA4F26AY	0.2	1	26	28.9	30.4	31.9	1	42.1	9.5	1.07	53.5	43	0.502	9.7
SMA4F28AY	0.2	1	28	31.1	32.7	34.3	1	45.4	8.8	1.26	59	39	0.633	9.8
SMA4F30AY	0.2	1	30	33.2	35	36.8	1	48.4	8.3	1.39	64.3	36	0.761	9.9
SMA4F31AY	0.2	1	31	34.2	36	37.8	1	50.2	8	1.56	65	35	0.77	9.9
SMA4F33AY	0.2	1	33	36.7	38.6	40.5	1	53.3	7.5	1.71	69.7	33	0.885	10
SMA4F36AY	0.2	1	36	40	42.1	44.2	1	58.1	6.9	2.01	76	30	1.06	10
SMA4F40AY	0.2	1	40	44.4	46.7	49	1	64.5	6.2	2.5	84	27	1.3	10.1
SMA4F48AY	0.2	1	48	53.2	56	58.8	1	77.4	5.2	3.56	100	23	1.79	10.3
SMA4F58AY	0.2	1	58	64.6	68	71.4	1	93.6	4.3	5.21	121	19	2.62	10.4
SMA4F70AY	0.2	1	70	77.9	82	86.1	1	113	3.5	7.71	146	16	3.75	10.5
SMA4F85AY	0.2	1	85	95	100	105	1	137	2.9	11.4	178	13	5.69	10.6
SMA4F100AY	0.2	1	100	111	117	123	1	162	2.5	15.6	212	11	8.09	10.7
SMA4F130AY	0.2	1	130	144	152	160	1	209	1.9	25.8	265	9	11.7	10.8
SMA4F154AY	0.2	1	154	171	180	189	1	246	1.6	35.6	317	7	18.3	10.8
SMA4F170AY	0.2	1	170	190	200	210	1	275	1.4	47	353	6.5	22.2	10.8
SMA4F188AY	0.2	1	188	209	220	231	1	328	1.4	69.3	388	6	26.2	10.8

1. To calculate V_{BR} versus T_j : V_{BR} at $T_j = V_{BR}$ at $25\text{ }^{\circ}\text{C} \times (1 + \alpha T \times (T_j - 25))$
2. To calculate V_{CL} versus T_j : V_{CL} at $T_j = V_{CL}$ at $25\text{ }^{\circ}\text{C} \times (1 + \alpha T \times (T_j - 25))$
3. To calculate V_{CLmax} versus $I_{PPappli}$: $V_{CLmax} = V_{BRmax} + R_D \times I_{PPappli}$
4. Surge capability given for both directions

1.1 Characteristics (curves)

Figure 3. Maximum peak power dissipation versus initial junction temperature

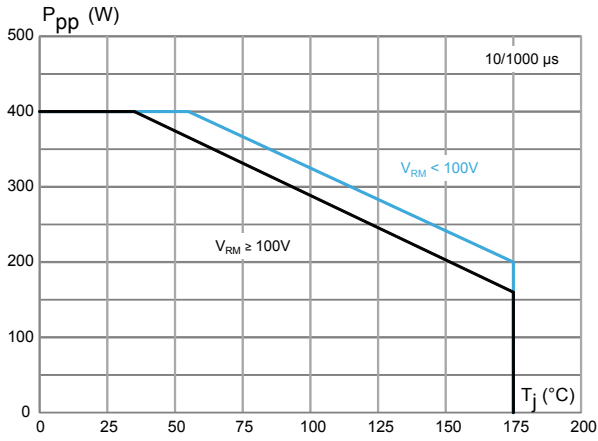

Figure 4. Maximum peak pulse power versus exponential pulse duration

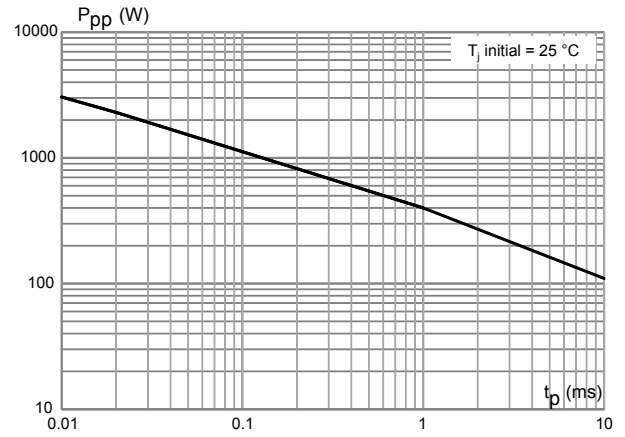

Figure 5. Maximum clamping voltage versus peak pulse current

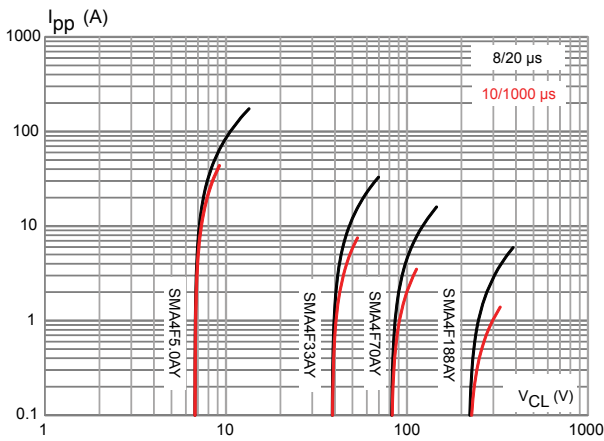

Figure 6. Dynamic resistance versus pulse duration

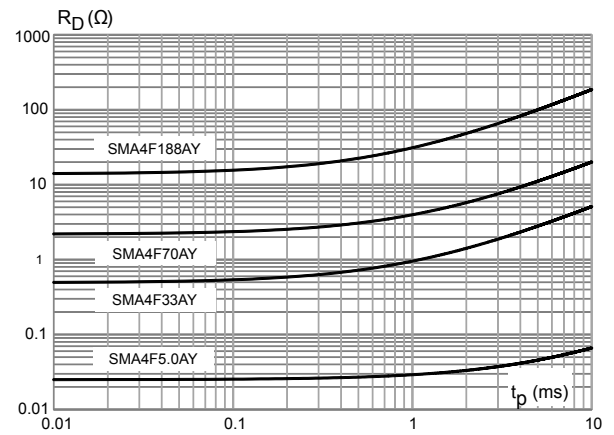

Figure 7. Junction capacitance versus reverse applied voltage (unidirectional types)

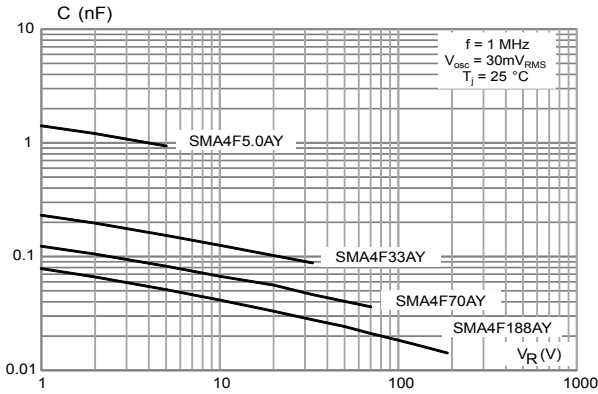

Figure 8. Leakage current versus junction temperature

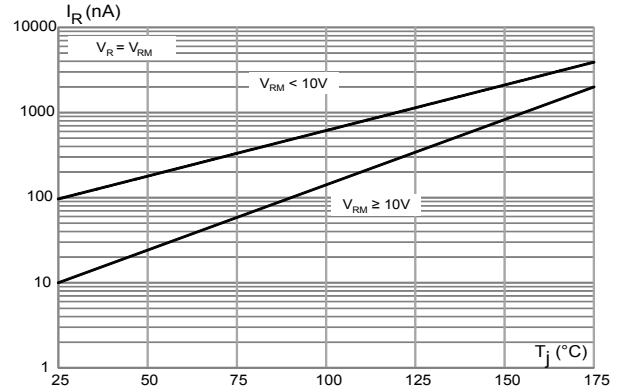

Figure 9. Peak forward voltage drop versus peak forward current

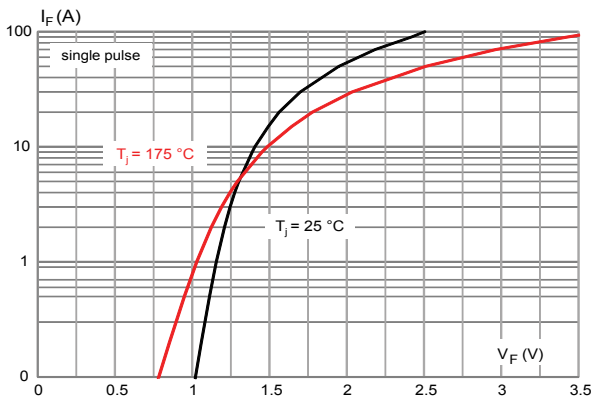

Figure 10. Thermal impedance junction to ambient versus pulse duration

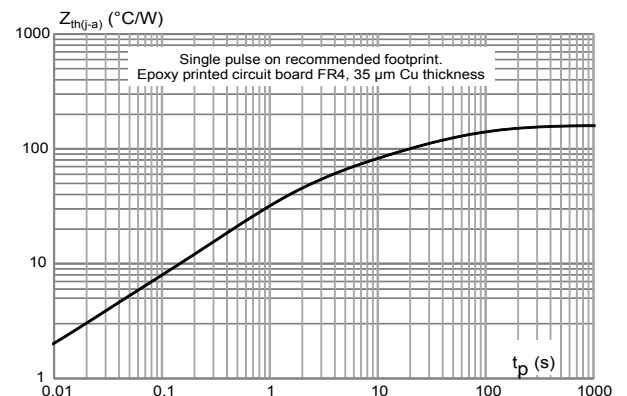

Figure 11. Thermal resistance junction to ambient versus copper area under each lead

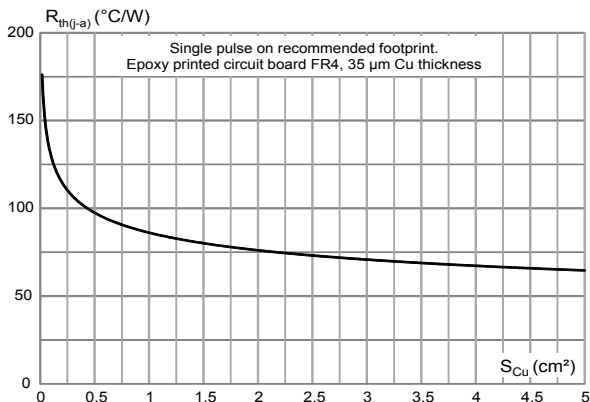

Figure 12. ISO7637-2 pulse 1: Vs = -150 V with 12 V battery

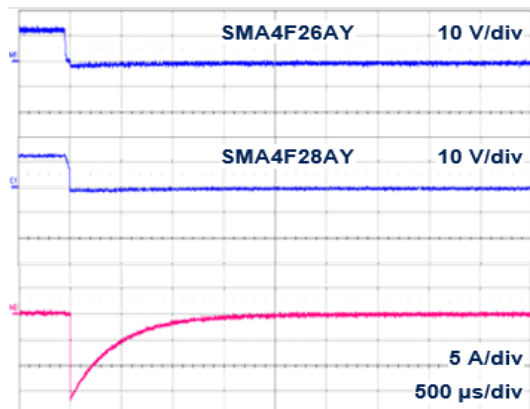

Figure 13. ISO7637-2 pulse 2a: $V_s = +112\text{ V}$ with 12 V battery

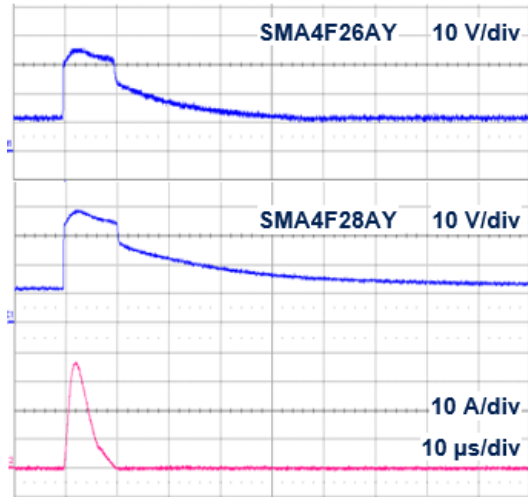

Figure 14. ISO7637-2 pulse 3a: $V_s = -220\text{ V}$ with 12 V battery

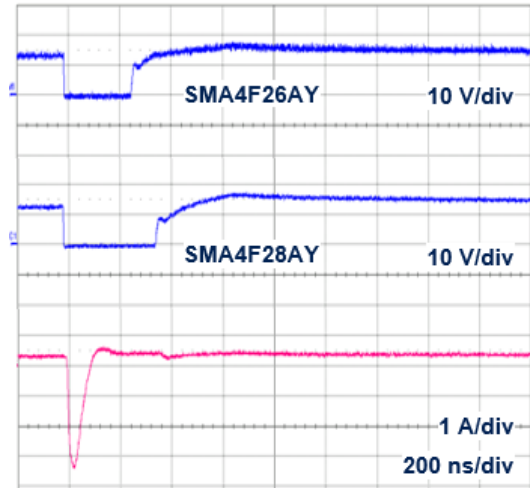
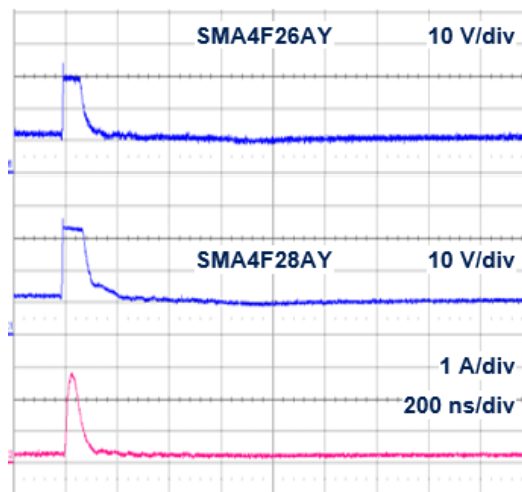

Figure 15. ISO7637-2 pulse 3b: $V_s = +150\text{ V}$ with 12 V battery



2 Package information

In order to meet environmental requirements, ST offers these devices in different grades of ECOPACK® packages, depending on their level of environmental compliance. ECOPACK® specifications, grade definitions and product status are available at: www.st.com. ECOPACK® is an ST trademark.

2.1 SMA Flat package information

Figure 16. SMA Flat package outline

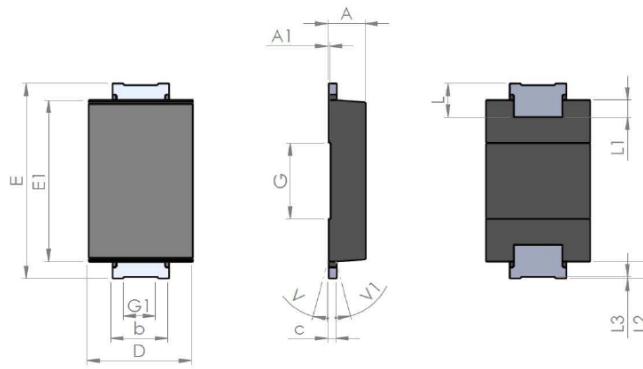

Table 3. SMA Flat mechanical data

Symbol	Millimeters			Inches ⁽¹⁾		
	Min	Typ	Max	Min	Typ	Max
A	0.90		1.10	0.035		0.044
A1		0.05			0.002	
b	1.25		1.65	0.049		0.065
c	0.15		0.40	0.005		0.016
D	2.25		2.90	0.088		0.115
E	5.00		5.35	0.196		0.211
E1	3.95		4.60	0.155		0.182
G		2.00			0.079	
G1		0.85			0.033	
L	0.75		1.20	0.029		0.048
L1		0.45			0.018	
L2		0.45			0.018	
L3		0.05			0.002	
V			8°			8°
V1			8°			8°

1. Values in inches are converted from mm and rounded to 3 decimal digits.

Figure 17. SMA Flat recommended footprint in mm (inches)

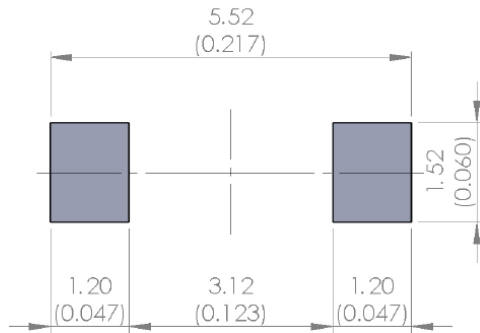

Figure 18. SMA Flat marking

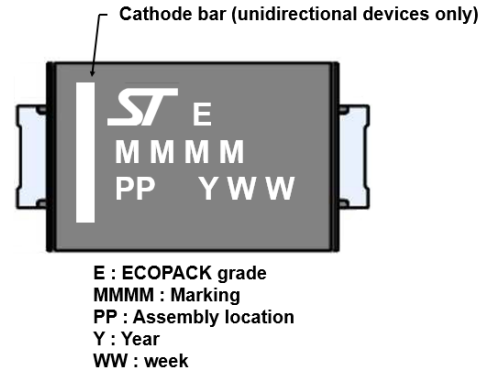
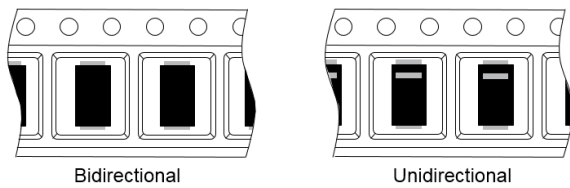

Figure 19. Package orientation in reel



Taped according to EIA-481
Pocket dimensions are not on scale.
Pocket shape may vary depending on package
On bidirectional devices, marking and logo may not be always in the same direction.

Figure 20. Tape and reel orientation

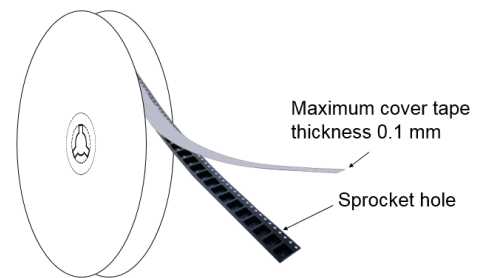

Figure 21. 13" reel dimension values

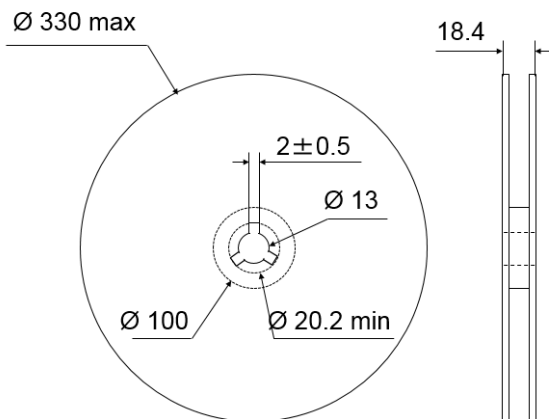

Figure 22. Inner box dimension values

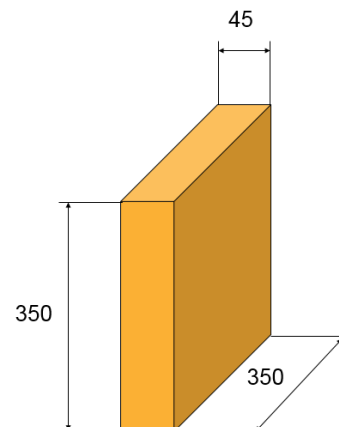
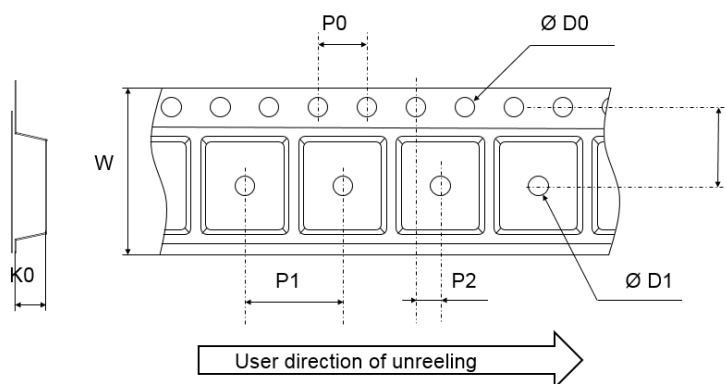

Figure 23. Tape outline



Note: Pocket dimensions are not on scale
Pocket shape may vary depending on package

Table 4. Tape dimension values

Ref.	Dimensions		
	Millimeters		
	Min.	Typ.	Max.
D0	1.5	1.55	1.6
D1	1.5		
F	5.4	5.5	5.6
K0	1.1	1.2	1.3
P0	3.9	4.0	4.1
P1	3.9	4.0	4.1
P2	1.9	2.0	2.1
W	11.7	12	12.3

2.2 Reflow profile

Figure 24. ST ECOPACK® recommended soldering reflow profile for PCB mounting

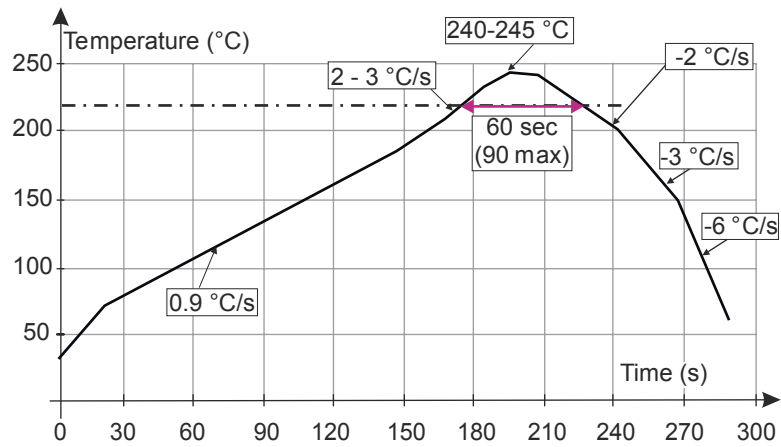

Note: Minimize air convection currents in the reflow oven to avoid component movement. Maximum soldering profile corresponds to the latest IPC/JEDEC J-STD-020.

3 Application and design guidelines

More information is available in the application note AN2689 “Protection of automotive electronics from electrical hazards, guidelines for design and component selection”.

4 Ordering information

Figure 25. Ordering information scheme

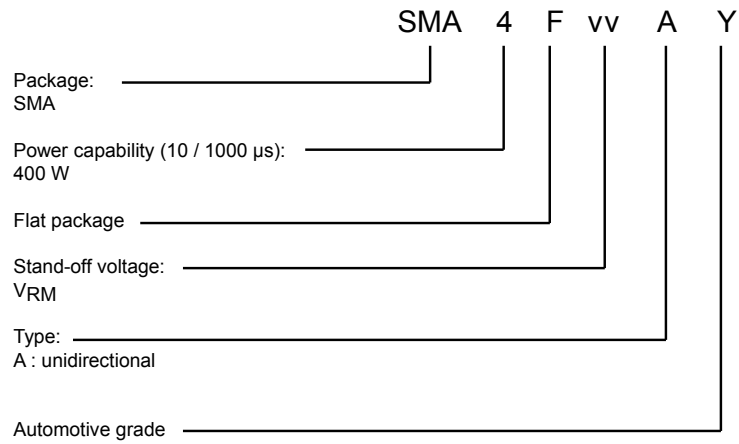

Table 5. Ordering information

Order code	Marking	Package	Weight	Base qty.	Delivery mode
SMA4FxxAY	See Table 6. Marking.	SMA Flat	39 mg	10000	Tape and reel

4.1 Marking

Table 6. Marking

Order code	Marking
SMA4F5.0AY	4AIY
SMA4F6.0AY	4AKY
SMA4F6.5AY	4ALY
SMA4F8.5AY	4APY
SMA4F10AY	4ASY
SMA4F11AY	4AUY
SMA4F12AY	4AWY
SMA4F13AY	4AYY
SMA4F14AY	4BAY
SMA4F15AY	4BCY
SMA4F16AY	4BEY
SMA4F18AY	4BIY
SMA4F20AY	4BMY
SMA4F22AY	4BOY
SMA4F23AY	4BPY
SMA4F24AY	4BQY
SMA4F26AY	4BSY
SMA4F28AY	4BUY
SMA4F30AY	4BWY
SMA4F31AY	4BXY
SMA4F33AY	4BZY
SMA4F36AY	4CCY
SMA4F40AY	4CGY
SMA4F48AY	4COY
SMA4F58AY	4CYY
SMA4F70AY	4DKY
SMA4F85AY	4DZY
SMA4F100AY	4EOY
SMA4F130AY	4FSY
SMA4F154AY	4GQY
SMA4F170AY	4HGY
SMA4F188AY	4HYY

Revision history

Table 7. Document revision history

Date	Version	Changes
01-Oct-2018	1	Initial release.
28-Feb-2019	2	Updated links syntax.

IMPORTANT NOTICE – PLEASE READ CAREFULLY

STMicroelectronics NV and its subsidiaries (“ST”) reserve the right to make changes, corrections, enhancements, modifications, and improvements to ST products and/or to this document at any time without notice. Purchasers should obtain the latest relevant information on ST products before placing orders. ST products are sold pursuant to ST’s terms and conditions of sale in place at the time of order acknowledgement.

Purchasers are solely responsible for the choice, selection, and use of ST products and ST assumes no liability for application assistance or the design of Purchasers’ products.

No license, express or implied, to any intellectual property right is granted by ST herein.

Resale of ST products with provisions different from the information set forth herein shall void any warranty granted by ST for such product.

ST and the ST logo are trademarks of ST. All other product or service names are the property of their respective owners.

Information in this document supersedes and replaces information previously supplied in any prior versions of this document.

© 2019 STMicroelectronics – All rights reserved