



SGM2021

Low Power, Low Dropout, Linear Regulators

GENERAL DESCRIPTION

The SGM2021 series low-power, low-noise, low-dropout, CMOS linear voltage regulators operate from a 2.5V to 5.5V input voltage. They are the perfect choice for low voltage, low power applications. A low ground current makes this part attractive for battery operated power systems. The SGM2021 series also offer ultra low dropout voltage to prolong battery life in portable electronics.

The SGM2021 features include foldback current limit and thermal shut-down protection.

The SGM2021 has Green SOT23-3 package. It operates over an ambient temperature range of -40°C to +85°C.

APPLICATIONS

- Cellular Telephones
- Cordless Telephones
- PHS Telephones
- PCMCIA Cards
- Modems
- MP3 Player
- Hand-Held Instruments
- Palmtop Computers
- Electronic Planners
- Portable/Battery-Powered Equipment

FEATURES

- Low Output Noise
- Low Dropout Voltage
- Maximum Output Current: 300mA
- Thermal-Overload Protection
- Output Current Limit
- Available in Multiple Output Voltage Versions
- Fixed Outputs of 0.9V, 1.2V, 1.3V, 1.5V, 1.8V, 2.1V, 2.5V, 2.6V, 2.7V, 2.8V, 2.85V, 2.9V, 3.0V, 3.1V, 3.2V, 3.3V, 3.6V, 4.2V, 5.0V
- -40°C to +85°C Operating Temperature Range
- Available in Green SOT23-3 Package

PRODUCT NAME STRUCTURE

SGM2021-XXX X XX G / TR

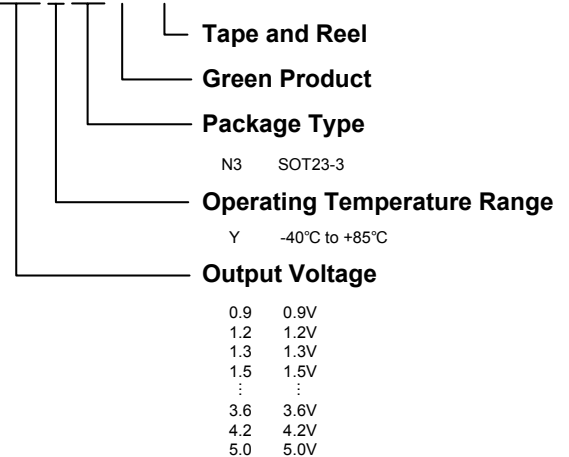

SGM2021

ABSOLUTE MAXIMUM RATINGS

IN to GND.....	-0.3V to 6V	Operating Temperature Range.....	-40°C to +85°C
Output Short-Circuit Duration.....	Infinite	Junction Temperature.....	150°C
OUT to GND.....	-0.3V to (V _{IN} + 0.3V)	Storage Temperature.....	-65 °C to +150°C
Power Dissipation, P _D @ T _A = 25°C		Lead Temperature (soldering, 10s).....	260°C
SOT23-3	0.4W	ESD Susceptibility	
Package Thermal Resistance		HBM.....	4000V
SOT23-3, θ _{JA}	250°C/W	MM.....	400V

Stresses beyond those listed under “Absolute Maximum Ratings” may cause permanent damage to the device. These are stress ratings only, and functional operation of the device at these or any other conditions beyond those indicated in the operational sections of the specifications is not implied. Exposure to absolute maximum rating conditions for extended periods may affect device reliability.

PIN CONFIGURATION (TOP VIEW)

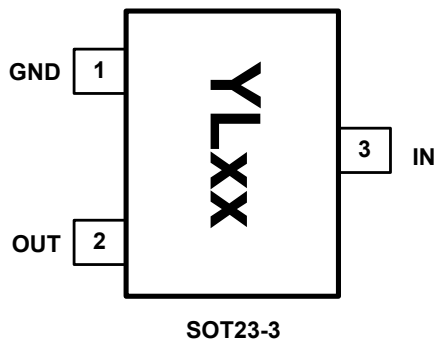

NOTE:

- (1) The location of pin 1 on the YLxx is determined by orienting the package marking as shown.
- (2) “xx” is the output voltage code. (For Example: when the output voltage is 1.8V, it is expressed as 18.)

TYPICAL APPLICATION CIRCUIT

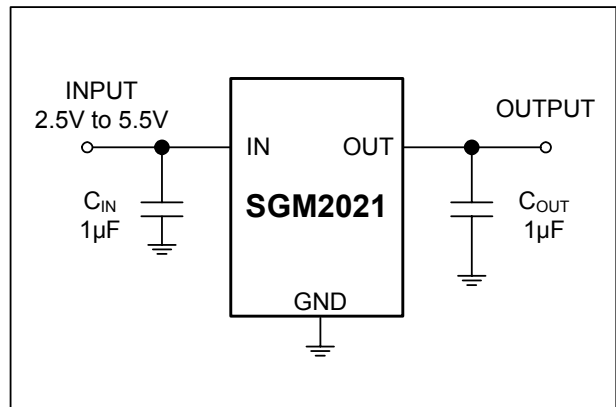

PIN DESCRIPTION

SOT23-3	NAME	FUNCTION
3	IN	Regulator Input. Supply voltage can range from 2.5V to 5.5V. Bypass with a 1µF capacitor to GND.
1	GND	Ground.
2	OUT	Regulator Output.

ELECTRICAL CHARACTERISTICS(V_{IN} = V_{OUT(NOMINAL)} + 0.5V⁽¹⁾, T_A = +25°C, unless otherwise noted.)

PARAMETER	SYMBOL	CONDITIONS	MIN	TYP	MAX	UNITS
Input Voltage	V _{IN}		2.5		5.5	V
Output Voltage Accuracy ⁽¹⁾		I _{OUT} = 0.1mA, T _A = +25°C	-2.2		2.2	%
Maximum Output Current			300			mA
Current Limit	I _{LIM}		310	500		mA
Ground Pin Current	I _Q	No load		120	220	μA
Dropout Voltage ⁽²⁾		I _{OUT} = 1mA		1		mV
		I _{OUT} = 300mA		270	420	
Line Regulation ⁽¹⁾	ΔV _{LNR}	V _{IN} = 2.5V or (V _{OUT} + 0.5V) to 5.5V I _{OUT} = 1mA		0.03	0.06	%/V
Load Regulation	ΔV _{LDR}	I _{OUT} = 0.1mA to 300mA, C _{OUT} = 1μF, V _{OUT} > 2V		0.003	0.006	%/mA
		I _{OUT} = 0.1mA to 300mA, C _{OUT} = 1μF, V _{OUT} ≤ 2V		0.005	0.012	
Output Voltage Noise	e _n	f = 10Hz to 100kHz, C _{OUT} = 10μF		120		μV _{RMS}
Power Supply Rejection Rate	PSRR	I _{LOAD} = 50mA, C _{OUT} = 1μF, V _{IN} = V _{OUT} +1V	f = 217Hz		62	dB
			f = 100Hz		69	dB
THERMAL PROTECTION						
Thermal Shutdown Temperature	T _{SHDN}			150		°C
Thermal Shutdown Hysteresis	ΔT _{SHDN}			15		°C

Note 1: V_{IN} = V_{OUT(NOMINAL)} + 0.5V or 2.5V, whichever is greater.**Note 2:** The dropout voltage is defined as V_{IN} - V_{OUT}, when V_{OUT} is 100mV below the value of V_{OUT} for V_{IN} = V_{OUT} + 0.5V. (Only applicable for V_{OUT} = +2.5V to +5.0V.)

Specifications subject to changes without notice.

TYPICAL OPERATING CHARACTERISTICS

$V_{IN} = V_{OUT(NOMINAL)} + 0.5V$ or $2.5V$ (whichever is greater), $C_{IN} = 1\mu F$, $C_{OUT} = 1\mu F$, $T_A = +25^\circ C$, unless otherwise noted.

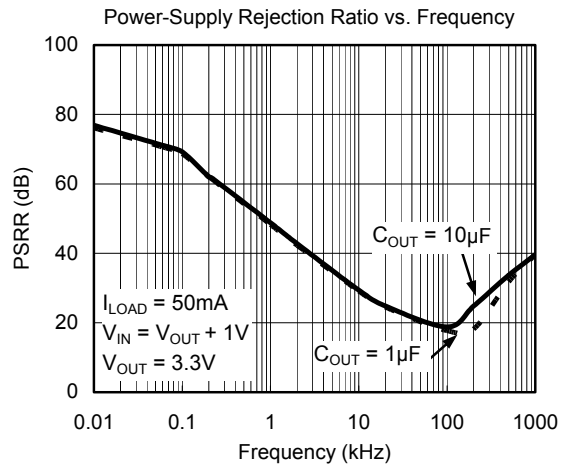
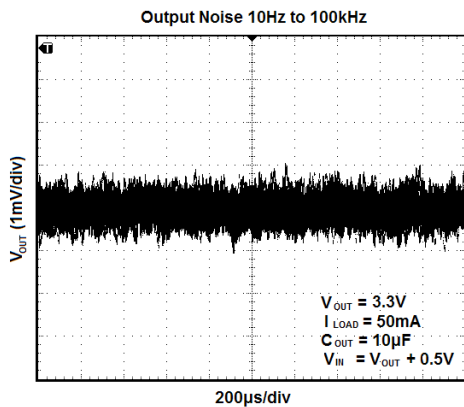
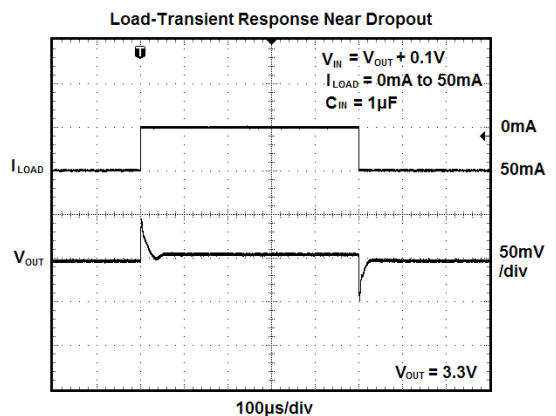
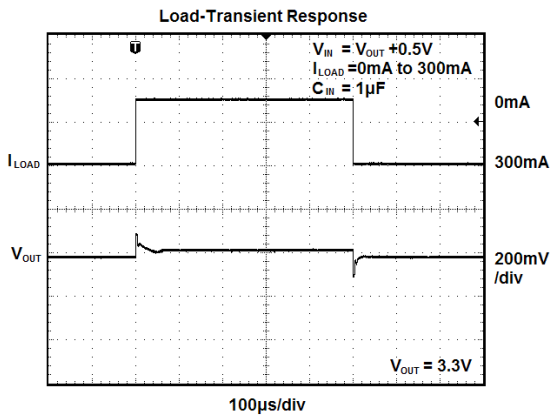
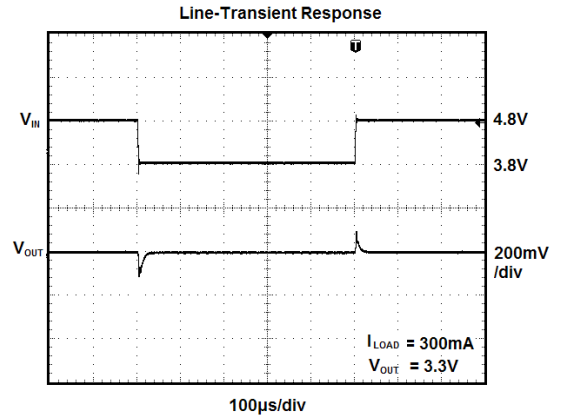
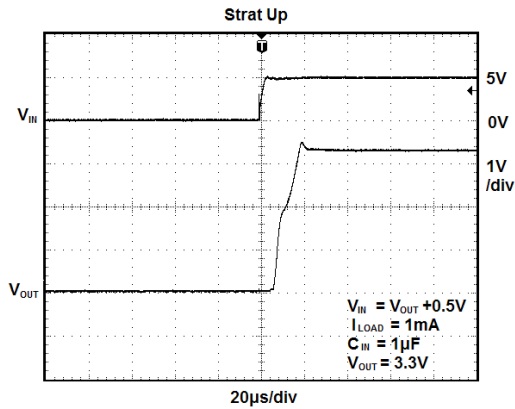

SGM2021

TYPICAL OPERATING CHARACTERISTICS

$V_{IN} = V_{OUT(NOMINAL)} + 0.5V$ or $2.5V$ (whichever is greater), $C_{IN} = 1\mu F$, $C_{OUT} = 1\mu F$, $T_A = +25^\circ C$, unless otherwise noted.

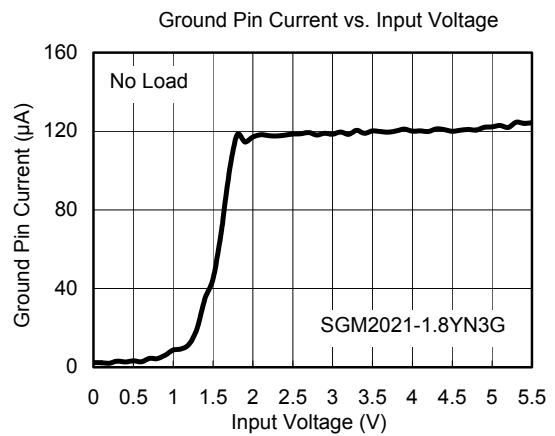
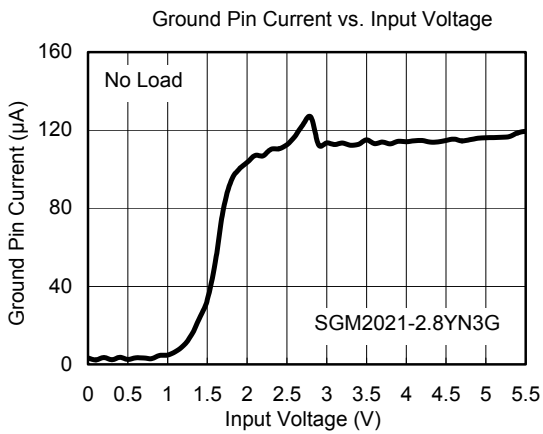
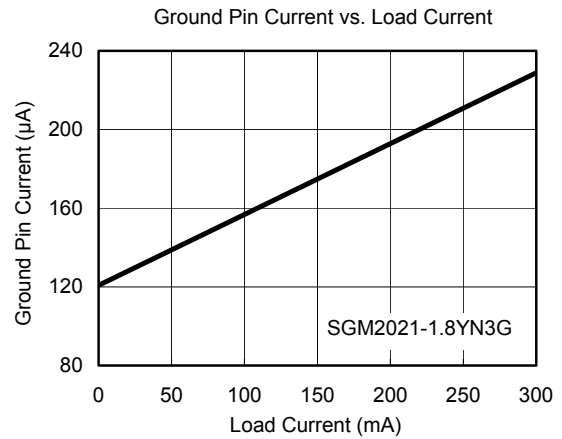
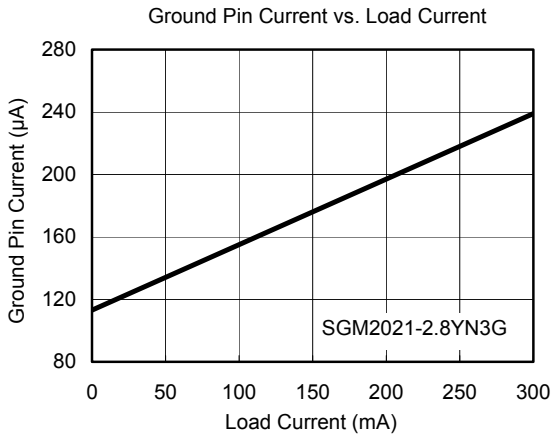
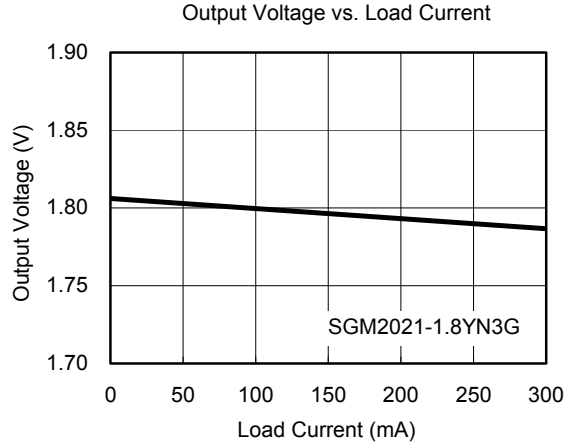
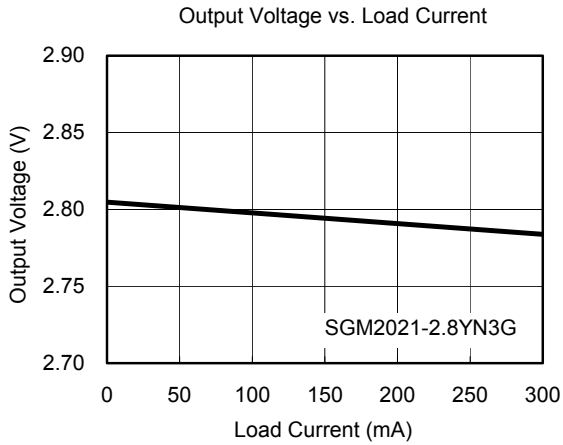

TYPICAL OPERATING CHARACTERISTICS

$V_{IN} = V_{OUT(NOMINAL)} + 0.5V$ or $2.5V$ (whichever is greater), $C_{IN} = 1\mu F$, $C_{OUT} = 1\mu F$, $T_A = +25^\circ C$, unless otherwise noted.

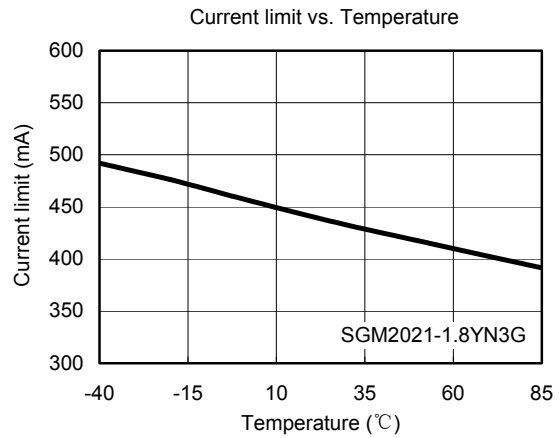
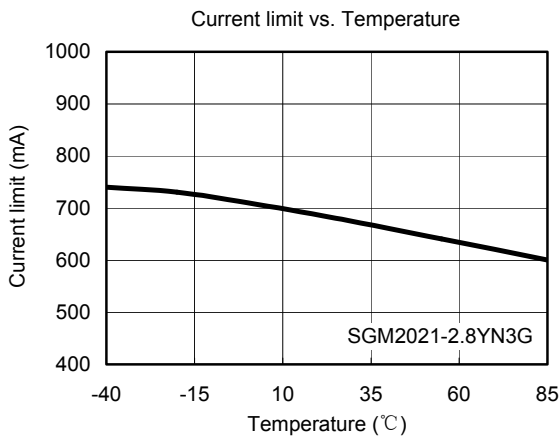
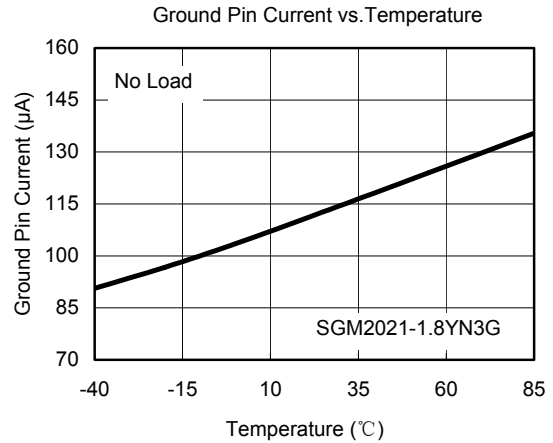
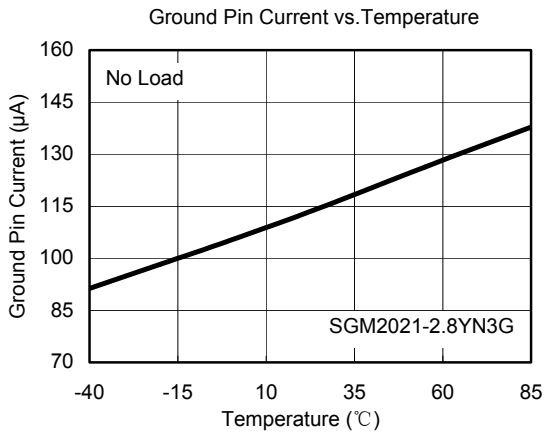
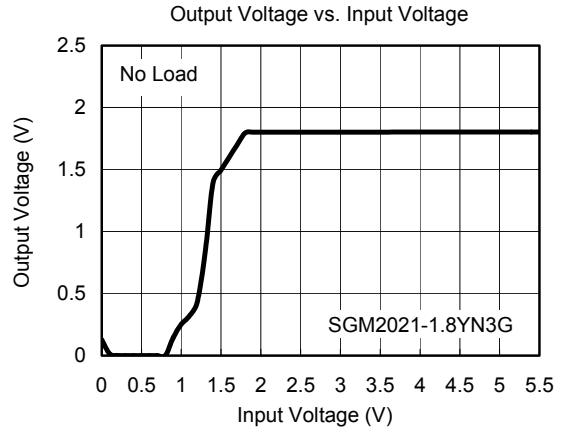
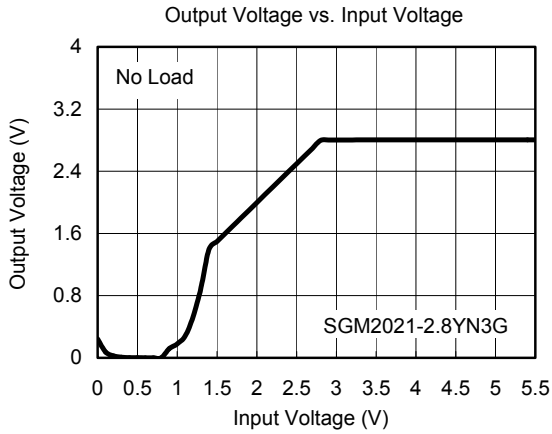

TYPICAL OPERATING CHARACTERISTICS

$V_{IN} = V_{OUT(NOMINAL)} + 0.5V$ or $2.5V$ (whichever is greater), $C_{IN} = 1\mu F$, $C_{OUT} = 1\mu F$, $T_A = +25^\circ C$, unless otherwise noted.

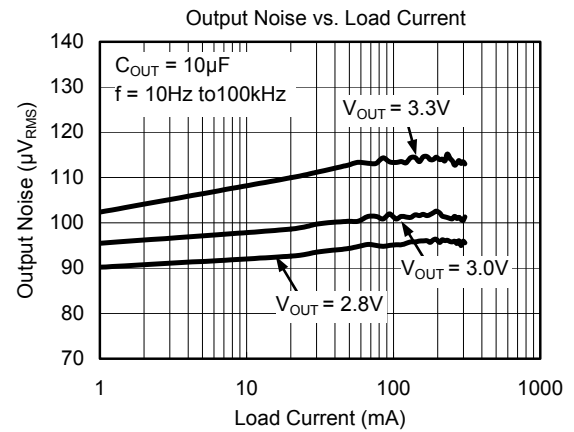
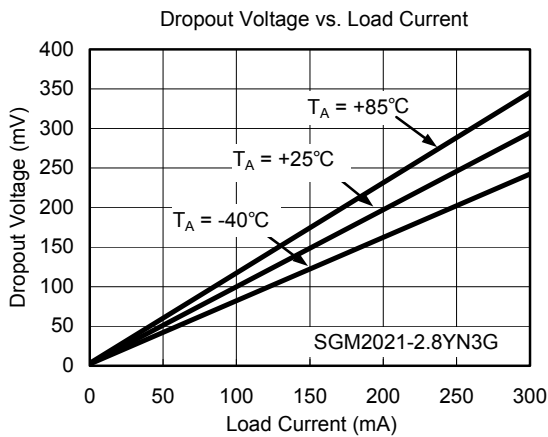
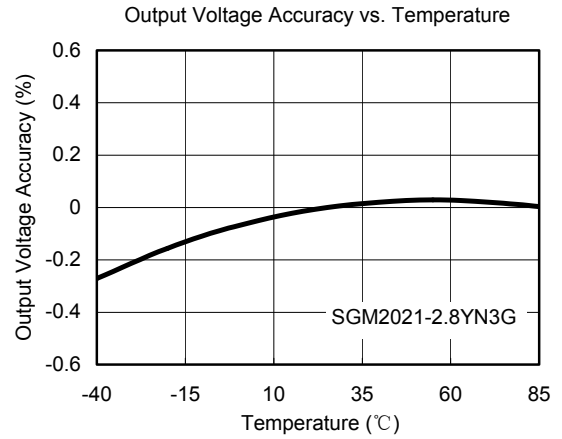
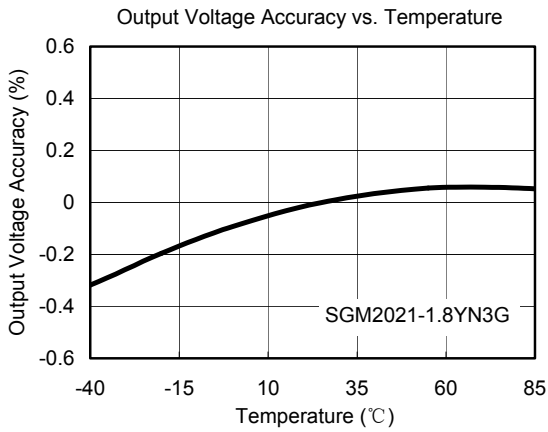

APPLICATION NOTE

When LDO is used in handheld products, attention must be paid to voltage spikes which could damage SGM2021. In such applications, voltage spikes will be generated at charger interface and V_{BUS} pin of USB interface when charger adapters and USB equipments are hot-plugged. Besides this, handheld products will be tested on the production line without battery. Test engineer will apply power from the connector pin which connects with positive pole of the battery. When external power supply is turned on suddenly, the voltage spikes will be generated at the battery connector. The voltage spikes will be very high, and it always exceeds the absolute maximum input voltage (6.0V) of LDO. In order to get robust design, design engineer needs to clear up this voltage spike. Zener diode is a cheap and effective solution to eliminate such voltage spike. For example, BZM55B5V6 is a 5.6V small package Zener diode which can be used to remove voltage spikes in cell phone designs. The schematic is shown below.

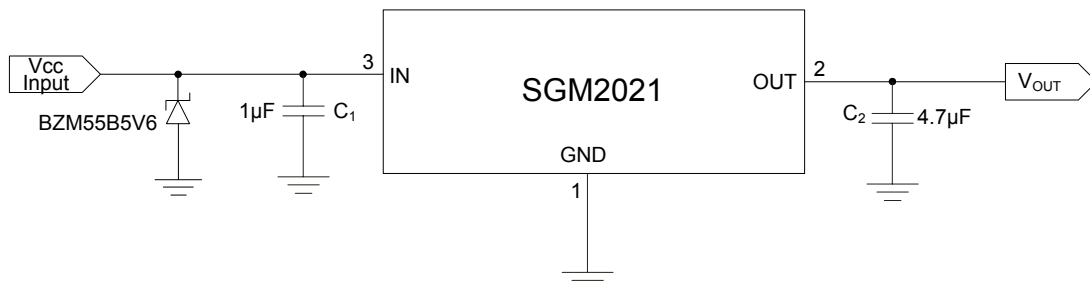

EXPANDED ORDERING INFORMATION

MODEL	V _{out} (V)	PIN-PACKAGE	ORDERING NUMBER	PACKAGE MARKING	PACKAGE OPTION
SGM2021-0.9	0.9V	SOT23-3	SGM2021-0.9YN3G/TR	YL09	Tape and Reel, 3000
SGM2021-1.2	1.2V	SOT23-3	SGM2021-1.2YN3G/TR	YL12	Tape and Reel, 3000
SGM2021-1.3	1.3V	SOT23-3	SGM2021-1.3YN3G/TR	YL13	Tape and Reel, 3000
SGM2021-1.5	1.5V	SOT23-3	SGM2021-1.5YN3G/TR	YL15	Tape and Reel, 3000
SGM2021-1.8	1.8V	SOT23-3	SGM2021-1.8YN3G/TR	YL18	Tape and Reel, 3000
SGM2021-2.1	2.1V	SOT23-3	SGM2021-2.1YN3G/TR	YL21	Tape and Reel, 3000
SGM2021-2.5	2.5V	SOT23-3	SGM2021-2.5YN3G/TR	YL25	Tape and Reel, 3000
SGM2021-2.6	2.6V	SOT23-3	SGM2021-2.6YN3G/TR	YL26	Tape and Reel, 3000
SGM2021-2.7	2.7V	SOT23-3	SGM2021-2.7YN3G/TR	YL27	Tape and Reel, 3000
SGM2021-2.8	2.8V	SOT23-3	SGM2021-2.8YN3G/TR	YL28	Tape and Reel, 3000
SGM2021-2.85	2.85V	SOT23-3	SGM2021-2.85YN3G/TR	YL2J	Tape and Reel, 3000
SGM2021-2.9	2.9V	SOT23-3	SGM2021-2.9YN3G/TR	YL29	Tape and Reel, 3000
SGM2021-3.0	3.0V	SOT23-3	SGM2021-3.0YN3G/TR	YL30	Tape and Reel, 3000
SGM2021-3.1	3.1V	SOT23-3	SGM2021-3.1YN3G/TR	YL31	Tape and Reel, 3000
SGM2021-3.2	3.2V	SOT23-3	SGM2021-3.2YN3G/TR	YL32	Tape and Reel, 3000
SGM2021-3.3	3.3V	SOT23-3	SGM2021-3.3YN3G/TR	YL33	Tape and Reel, 3000
SGM2021-3.6	3.6V	SOT23-3	SGM2021-3.6YN3G/TR	YL36	Tape and Reel, 3000
SGM2021-4.2	4.2V	SOT23-3	SGM2021-4.2YN3G/TR	YL42	Tape and Reel, 3000
SGM2021-5.0	5.0V	SOT23-3	SGM2021-5.0YN3G/TR	YL50	Tape and Reel, 3000

PACKAGE OUTLINE DIMENSIONS

SOT23-3

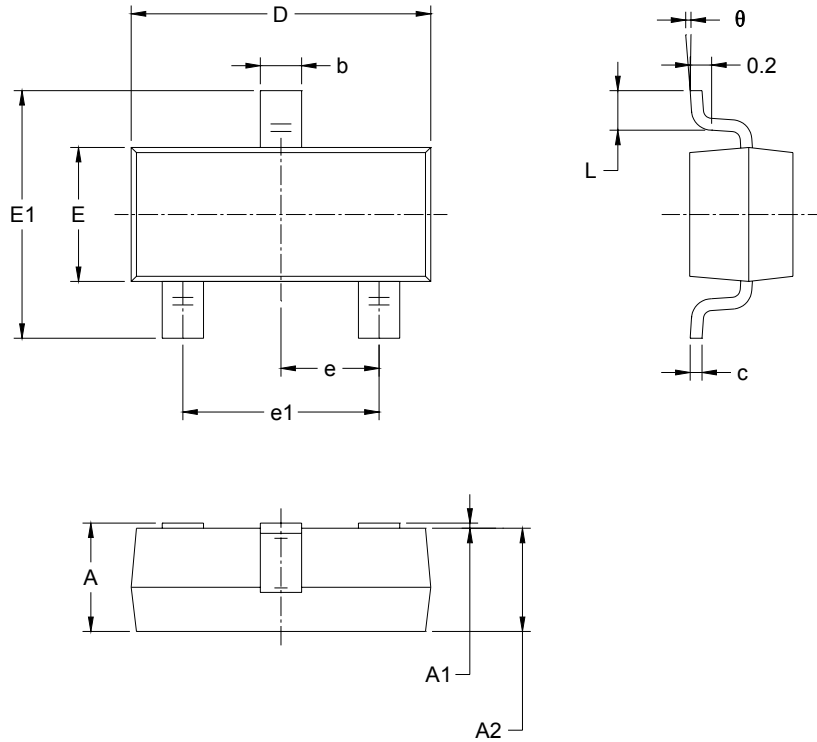

Symbol	Dimensions In Millimeters		Dimensions In Inches	
	Min	Max	Min	Max
A	1.050	1.250	0.041	0.049
A1	0.000	0.100	0.000	0.004
A2	1.050	1.150	0.041	0.045
b	0.300	0.500	0.012	0.020
c	0.100	0.200	0.004	0.008
D	2.820	3.020	0.111	0.119
E	1.500	1.700	0.059	0.067
E1	2.650	2.950	0.104	0.116
e	0.950 BSC		0.037 BSC	
e1	1.900 BSC		0.075 BSC	
L	0.300	0.600	0.012	0.024
θ	0°	8°	0°	8°

02/2010 REV. A.1

SGMICRO is dedicated to provide high quality and high performance analog IC products to customers. All SGMICRO products meet the highest industry standards with strict and comprehensive test and quality control systems to achieve world-class consistency and reliability.

For more information regarding SGMICRO Corporation and its products, please visit www.sg-micro.com