



SGM8270-4

Low Noise, Precision, High Voltage, Rail-to-Rail I/O Operational Amplifier

GENERAL DESCRIPTION

The SGM8270-4 is a quad, low noise, precision, high voltage operational amplifier, which can operate from 3.3V to 36V single supply or from $\pm 1.65V$ to $\pm 18V$ dual power supplies. It provides rail-to-rail input with a wide input common mode voltage range and rail-to-rail output voltage swing.

The SGM8270-4 provides high slew rate, low noise, bias current and offset.

The SGM8270-4 is available in Green SOIC-14 and TSSOP-14 packages. It is specified over the extended $-40^{\circ}C$ to $+125^{\circ}C$ temperature range.

FEATURES

- Rail-to-Rail Input and Output
- Wide Input Common Mode and Differential Voltage Ranges
- Low Offset Voltage: 1.2mV (MAX)
- Low Input Bias Current
- Low Input Offset Current
- Output Short-Circuit Protection
- High Input Impedance
- Low Noise: $15nV/\sqrt{Hz}$ at 1kHz
- Gain-Bandwidth Product: 2.2MHz
- High Slew Rate: 8V/ μs
- $-40^{\circ}C$ to $+125^{\circ}C$ Operating Temperature Range
- Available in Green SOIC-14 and TSSOP-14 Packages

APPLICATIONS

High Impedance Sensor
Photodiode Amplifier
High End, Professional Audio
DAC Output Amplifier
Medical

PACKAGE/ORDERING INFORMATION

MODEL	PACKAGE DESCRIPTION	SPECIFIED TEMPERATURE RANGE	ORDERING NUMBER	PACKAGE MARKING	PACKING OPTION
SGM8270-4	SOIC-14	-40°C to +125°C	SGM8270-4XS14G/TR	SGM82704XS14 XXXXX	Tape and Reel, 2500
	TSSOP-14	-40°C to +125°C	SGM8270-4XTS14G/TR	SGM82704 XTS14 XXXXX	Tape and Reel, 4000

MARKING INFORMATION

XXXXX = Date Code, Trace Code and Vendor Code.

XXXXX

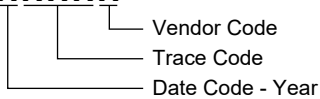

Green (RoHS & HSF): SG Micro Corp defines "Green" to mean Pb-Free (RoHS compatible) and free of halogen substances. If you have additional comments or questions, please contact your SGMICRO representative directly.

ABSOLUTE MAXIMUM RATINGS

Supply Voltage, +V _S to -V _S	40V
Input/Output Voltage Range.....(-V _S) - 0.3V to (+V _S) + 0.3V	
Power Dissipation, P _D @ T _A = +25°C	
SOIC-14.....	1.5W
TSSOP-14.....	1.1W
Package Thermal Resistance	
SOIC-14, θ _{JA}	81°C/W
SOIC-14, θ _{JC}	32°C/W
TSSOP-14, θ _{JA}	108°C/W
TSSOP-14, θ _{JC}	35°C/W
Junction Temperature.....	+150°C
Storage Temperature Range.....	-65°C to +150°C
Lead Temperature (Soldering, 10s).....	+260°C
ESD Susceptibility	
HBM.....	6000V
CDM.....	1000V

RECOMMENDED OPERATING CONDITIONS

Operating Temperature Range.....	-40°C to +125°C
----------------------------------	-----------------

NOTE:

1. Proper power supply sequencing is recommended for the CMOS device. Always sequence V_S on first, followed by the inputs and outputs.

OVERSTRESS CAUTION

Stresses beyond those listed in Absolute Maximum Ratings may cause permanent damage to the device. Exposure to absolute maximum rating conditions for extended periods may affect reliability. Functional operation of the device at any conditions beyond those indicated in the Recommended Operating Conditions section is not implied.

ESD SENSITIVITY CAUTION

This integrated circuit can be damaged if ESD protections are not considered carefully. SGMICRO recommends that all integrated circuits be handled with appropriate precautions. Failure to observe proper handling and installation procedures can cause damage. ESD damage can range from subtle performance degradation to complete device failure. Precision integrated circuits may be more susceptible to damage because even small parametric changes could cause the device not to meet the published specifications.

DISCLAIMER

SG Micro Corp reserves the right to make any change in circuit design, or specifications without prior notice.

PIN CONFIGURATIONS

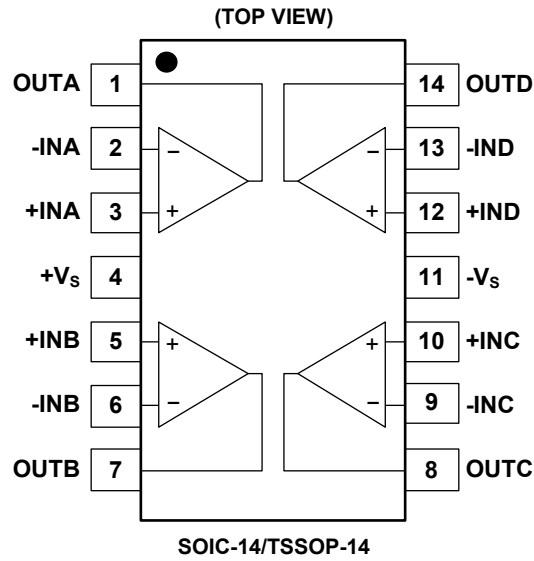

ELECTRICAL CHARACTERISTICS

(At $T_A = +25^\circ\text{C}$, $V_S = \pm 1.65\text{V}$ to $\pm 18\text{V}$ and $R_L = 2\text{k}\Omega$ connected to 0V , Full = -40°C to $+125^\circ\text{C}$, unless otherwise noted.)

PARAMETER	SYMBOL	CONDITIONS	TEMP	MIN	TYP	MAX	UNITS
Input Characteristics							
Input Offset Voltage	V_{OS}	$V_{CM} = 0\text{V}$	$+25^\circ\text{C}$		0.2	1.2	mV
			Full			1.4	
Input Offset Voltage Drift	$\Delta V_{OS}/\Delta T$		Full		0.8		$\mu\text{V}/^\circ\text{C}$
Input Bias Current	I_B	$V_{CM} = 0\text{V}$	$+25^\circ\text{C}$		± 5	± 120	pA
Input Offset Current	I_{OS}	$V_{CM} = 0\text{V}$	$+25^\circ\text{C}$		± 5	± 120	pA
Maximum Differential Input Voltage	$ V_{ID} $		Full			V_S	V
Maximum Input Difference Bias Current	$ I_{ID} $	$V_S = \pm 18\text{V}$, $V_{ID} = \pm 18\text{V}$	$+25^\circ\text{C}$		2	3	μA
			Full			4	
Input Common Mode Voltage Range	V_{CM}		Full	$(-V_S) - 0.1$		$(+V_S) + 0.1$	V
Common Mode Rejection Ratio	CMRR	$V_S = \pm 18\text{V}$, $(-V_S) - 0.1\text{V} < V_{CM} < (+V_S) - 1.5\text{V}$	$+25^\circ\text{C}$	96	110		dB
			Full	85			
		$V_S = \pm 18\text{V}$, $(-V_S) - 0.1\text{V} < V_{CM} < (+V_S) + 0.1\text{V}$	$+25^\circ\text{C}$	78	88		
			Full	75			
Open-Loop Voltage Gain	A_{OL}	$(-V_S) + 0.2\text{V} < V_{OUT} < (+V_S) - 0.2\text{V}$, $R_L = 10\text{k}\Omega$	$+25^\circ\text{C}$	101	130		dB
			Full	98			
		$(-V_S) + 0.5\text{V} < V_{OUT} < (+V_S) - 0.5\text{V}$, $R_L = 2\text{k}\Omega$	$+25^\circ\text{C}$	101	120		
			Full	81			
Output Characteristics							
Output Voltage Swing from Rail	V_{OUT}	$V_S = \pm 18\text{V}$, $R_L = 10\text{k}\Omega$	$+25^\circ\text{C}$		65	85	mV
			Full			110	
		$V_S = \pm 18\text{V}$, $R_L = 2\text{k}\Omega$	$+25^\circ\text{C}$		320	420	
			Full			550	
Output Short-Circuit Current	I_{SC}	$V_S = \pm 18\text{V}$	$+25^\circ\text{C}$	± 28	± 40		mA
Power Supply							
Operating Voltage Range	V_S		Full	3.3		36	V
Quiescent Current	I_Q	$I_{OUT} = 0$	$+25^\circ\text{C}$		2	2.6	mA
			Full			3	
Power Supply Rejection Ratio	PSRR	$V_S = 3.3\text{V}$ to 36V	$+25^\circ\text{C}$	105	125		dB
			Full	102			
Dynamic Performance							
Gain-Bandwidth Product	GBP	$C_L = 50\text{pF}$	$+25^\circ\text{C}$		2.2		MHz
Phase Margin	ϕ_O	$C_L = 50\text{pF}$	$+25^\circ\text{C}$		65		$^\circ$
Slew Rate	SR	$V_S = \pm 2.5\text{V}$ to $\pm 18\text{V}$, $G = +1$	$+25^\circ\text{C}$		8		$\text{V}/\mu\text{s}$
Overload Recovery Time	ORT	$V_{IN} \times G > V_S$	$+25^\circ\text{C}$		1		μs
Total Harmonic Distortion + Noise	THD+N	$V_S = \pm 2.5\text{V}$ to $\pm 18\text{V}$, $V_{OUT} = 2V_{P-P}$, $f = 1\text{kHz}$, $G = +1$, $R_L = 600\Omega$	$+25^\circ\text{C}$		0.002		%
			$+25^\circ\text{C}$		0.0005		
Noise							
Input Voltage Noise		$f = 0.1\text{Hz}$ to 10Hz	$+25^\circ\text{C}$		3.5		μV_{P-P}
Input Voltage Noise Density	e_n	$f = 10\text{Hz}$	$+25^\circ\text{C}$		80		$\text{nV}/\sqrt{\text{Hz}}$
		$f = 1\text{kHz}$	$+25^\circ\text{C}$		15		
Input Current Noise Density	i_n	$f = 1\text{kHz}$	$+25^\circ\text{C}$		300		$\text{fA}/\sqrt{\text{Hz}}$

TYPICAL PERFORMANCE CHARACTERISTICS

At $T_A = +25^\circ\text{C}$, $V_S = 36\text{V}$ and $R_L = 2\text{k}\Omega$, unless otherwise noted.

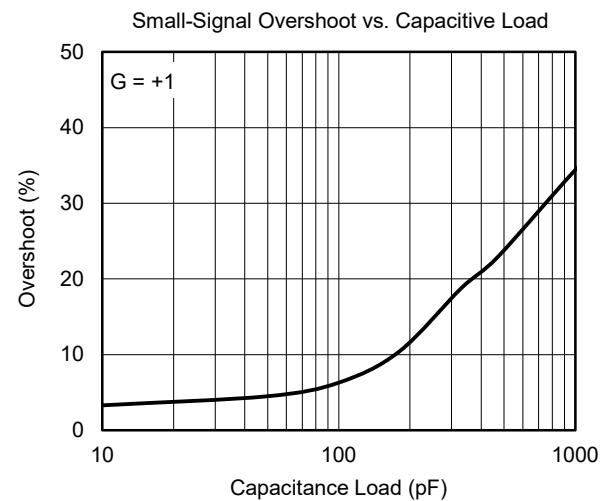
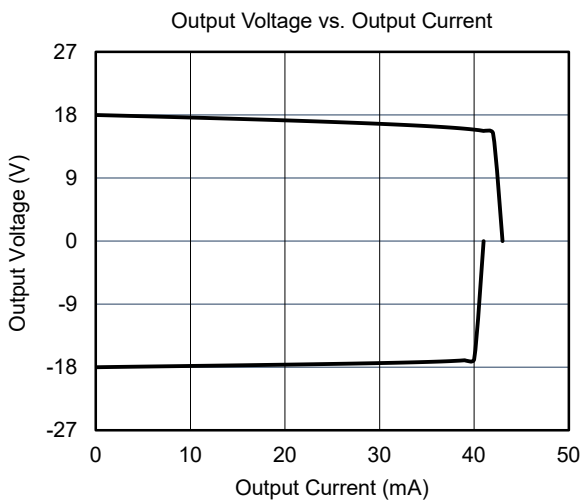
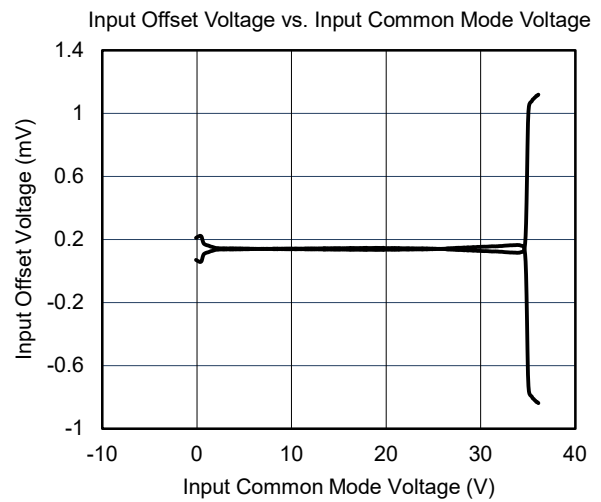
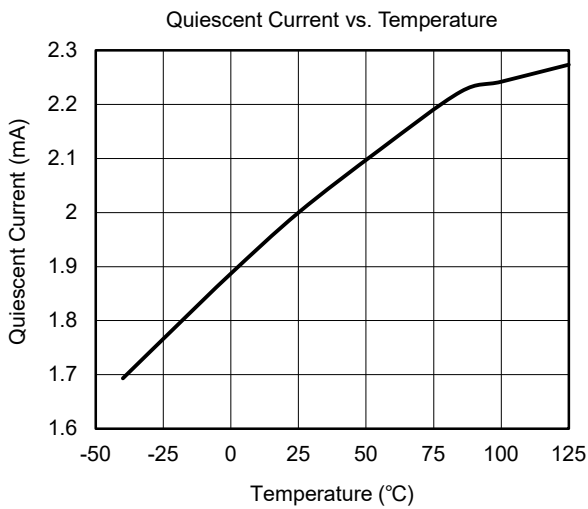
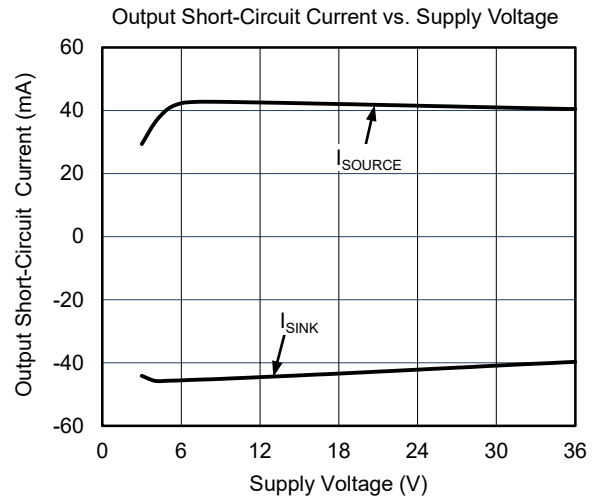
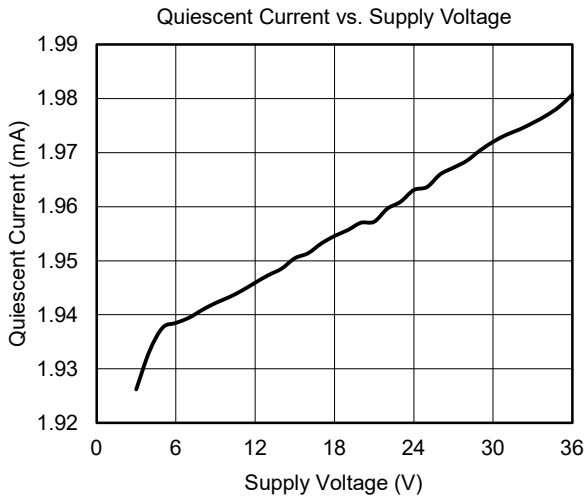

TYPICAL PERFORMANCE CHARACTERISTICS (continued)

At $T_A = +25^\circ\text{C}$, $V_S = 36\text{V}$ and $R_L = 2\text{k}\Omega$, unless otherwise noted.

Large-Signal Step Response

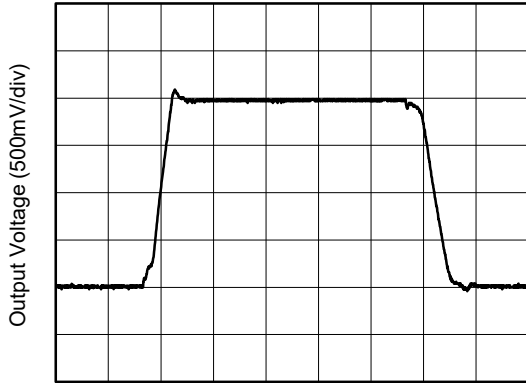

Time (500ns/div)

Small-Signal Step Response



Time (500ns/div)

CMRR and PSRR vs. Frequency

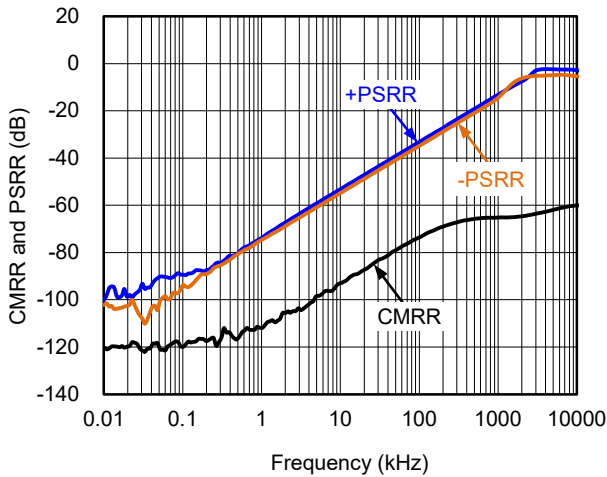

Frequency (kHz)

Open-Loop Gain and Phase vs. Frequency

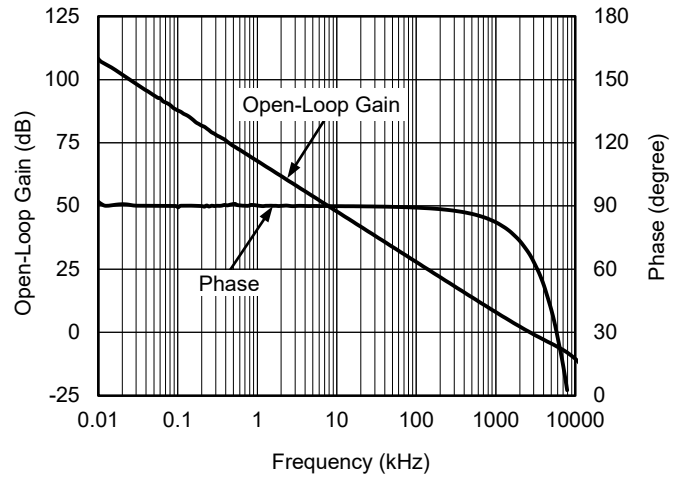

Frequency (kHz)

Maximum Output Voltage vs. Frequency

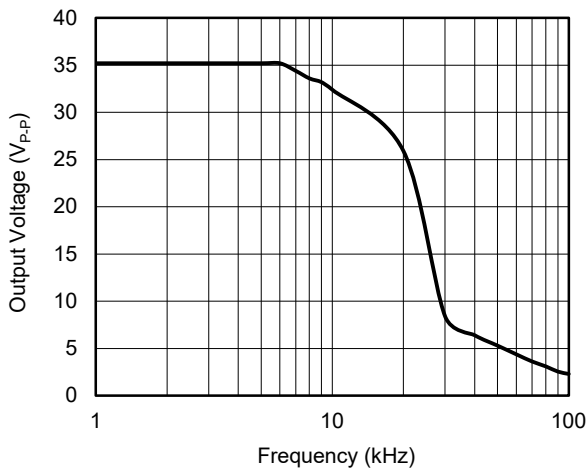

Frequency (kHz)

Input Voltage Noise Density vs. Frequency

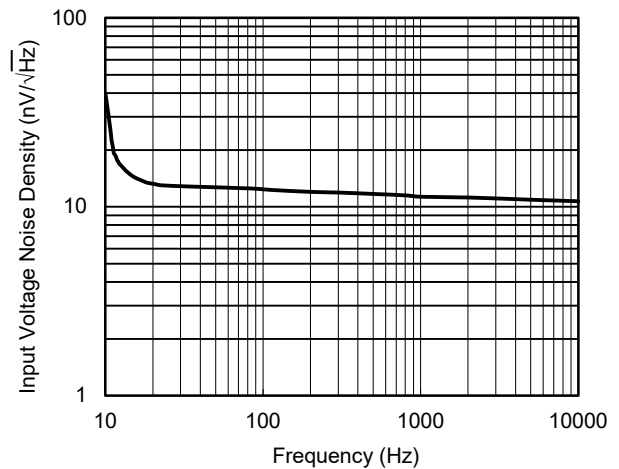

Frequency (Hz)

TYPICAL PERFORMANCE CHARACTERISTICS (continued)

At $T_A = +25^\circ\text{C}$, $V_S = 36\text{V}$ and $R_L = 2\text{k}\Omega$, unless otherwise noted.

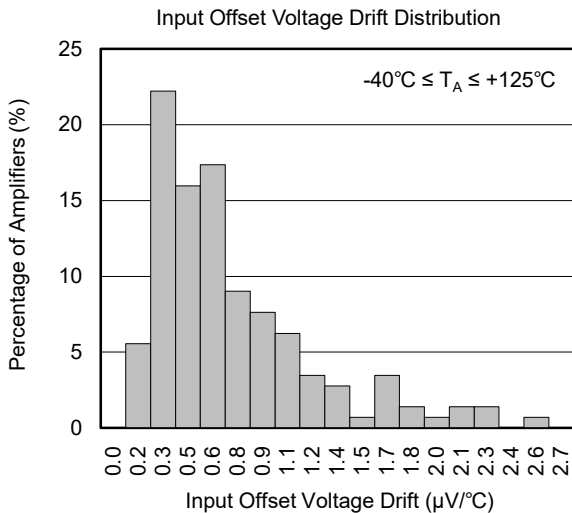
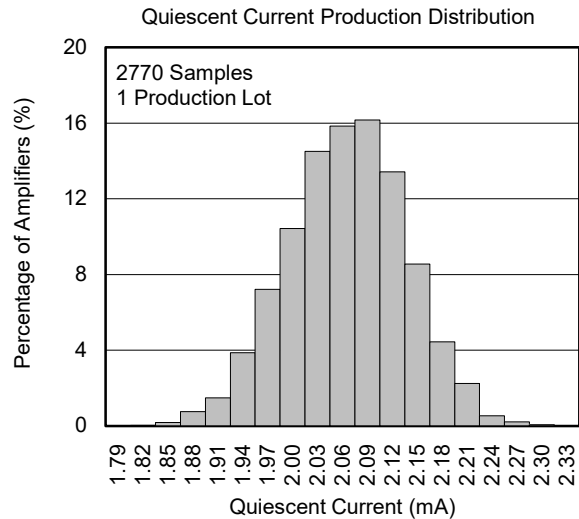
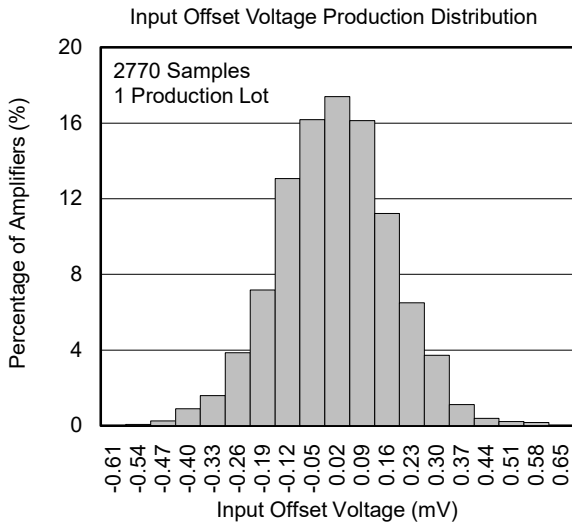
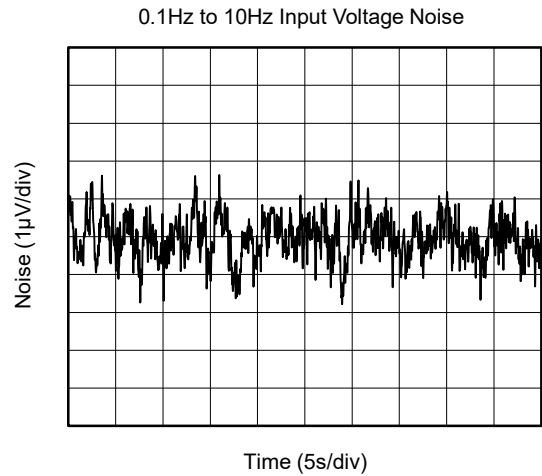
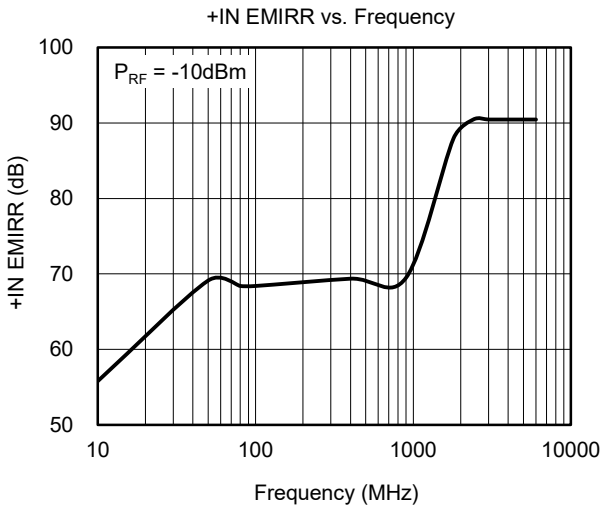

REVISION HISTORY

NOTE: Page numbers for previous revisions may differ from page numbers in the current version.

DECEMBER 2020 – REV.A to REV.A.1	Page
Updated Absolute Maximum Ratings section.....	2

Changes from Original (AUGUST 2019) to REV.A	Page
Changed from product preview to production data.....	All

PACKAGE INFORMATION

PACKAGE OUTLINE DIMENSIONS

SOIC-14

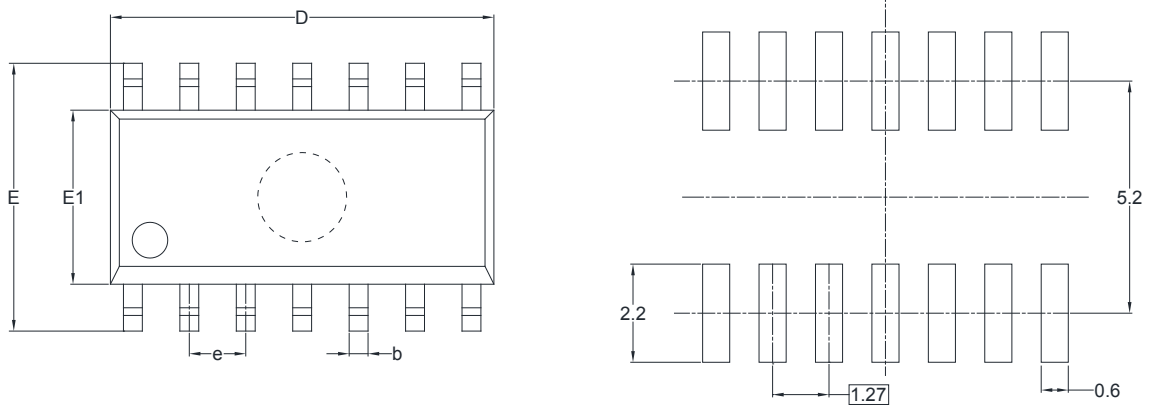

RECOMMENDED LAND PATTERN (Unit: mm)

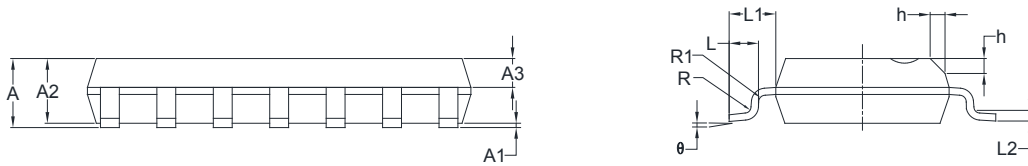

Symbol	Dimensions In Millimeters		Dimensions In Inches	
	MIN	MAX	MIN	MAX
A	1.35	1.75	0.053	0.069
A1	0.10	0.25	0.004	0.010
A2	1.25	1.65	0.049	0.065
A3	0.55	0.75	0.022	0.030
b	0.36	0.49	0.014	0.019
D	8.53	8.73	0.336	0.344
E	5.80	6.20	0.228	0.244
E1	3.80	4.00	0.150	0.157
e	1.27 BSC		0.050 BSC	
L	0.45	0.80	0.018	0.032
L1	1.04 REF		0.040 REF	
L2	0.25 BSC		0.01 BSC	
R	0.07		0.003	
R1	0.07		0.003	
h	0.30	0.50	0.012	0.020
θ	0°	8°	0°	8°

PACKAGE OUTLINE DIMENSIONS

TSSOP-14

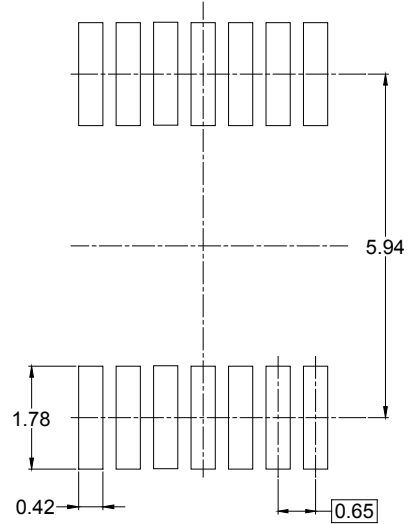
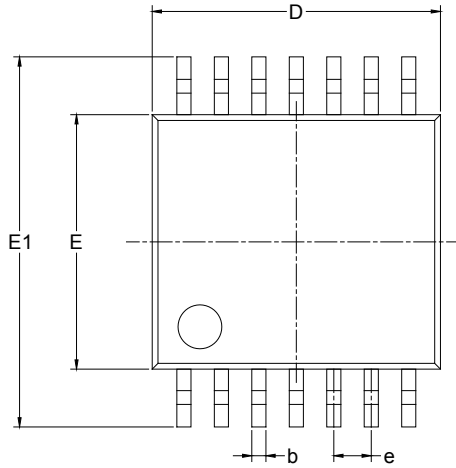

RECOMMENDED LAND PATTERN (Unit: mm)

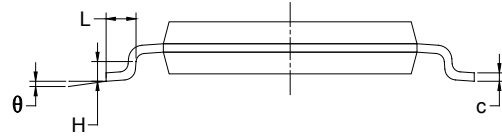
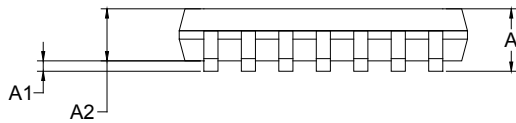

Symbol	Dimensions In Millimeters		Dimensions In Inches	
	MIN	MAX	MIN	MAX
A		1.200		0.047
A1	0.050	0.150	0.002	0.006
A2	0.800	1.050	0.031	0.041
b	0.190	0.300	0.007	0.012
c	0.090	0.200	0.004	0.008
D	4.860	5.100	0.191	0.201
E	4.300	4.500	0.169	0.177
E1	6.250	6.550	0.246	0.258
e	0.650 BSC		0.026 BSC	
L	0.500	0.700	0.02	0.028
H	0.25 TYP		0.01 TYP	
θ	1°	7°	1°	7°

TAPE AND REEL INFORMATION

REEL DIMENSIONS

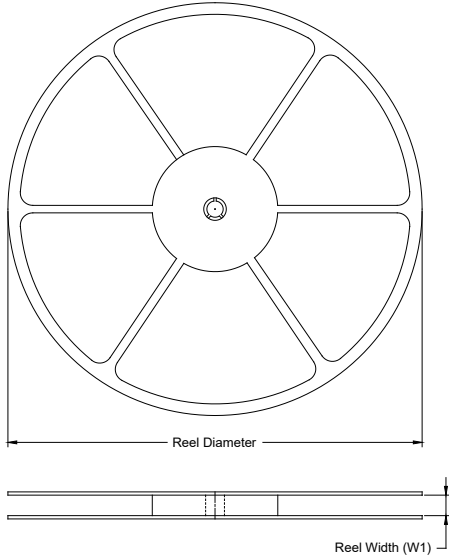

TAPE DIMENSIONS

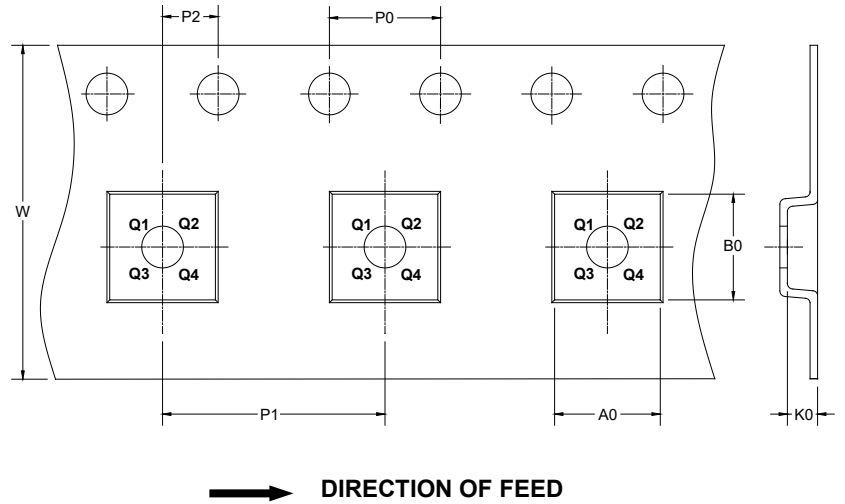

NOTE: The picture is only for reference. Please make the object as the standard.

KEY PARAMETER LIST OF TAPE AND REEL

Package Type	Reel Diameter	Reel Width W1 (mm)	A0 (mm)	B0 (mm)	K0 (mm)	P0 (mm)	P1 (mm)	P2 (mm)	W (mm)	Pin1 Quadrant
SOIC-14	13"	16.4	6.60	9.30	2.10	4.0	8.0	2.0	16.0	Q1
TSSOP-14	13"	12.4	6.95	5.60	1.20	4.0	8.0	2.0	12.0	Q1

000001

PACKAGE INFORMATION

CARTON BOX DIMENSIONS



NOTE: The picture is only for reference. Please make the object as the standard.

KEY PARAMETER LIST OF CARTON BOX

Reel Type	Length (mm)	Width (mm)	Height (mm)	Pizza/Carton
13"	386	280	370	5

DD0002