

Description

RailClamp® TVS arrays are ultra low capacitance ESD protection devices designed to protect high speed data interfaces. This series has been specifically designed to protect sensitive components which are connected to high-speed data and transmission lines from overvoltage caused by **ESD** (electrostatic discharge), **CDE** (Cable Discharge Events), and **EFT** (electrical fast transients).

The RClamp®7522T has a typical capacitance of only 0.25pF. This allows it to be used on circuits operating in excess of 3GHz without signal attenuation. Each device will protect two data lines and the voltage supply bus in USB applications. Steering diodes serve as backdrive protection on the VBus pin for operation during power-down. The device may also be used to protect up to three high speed data lines in applications such as camera data lines in mobile phones.

The RClamp7522T is in a 5-pin SLP1007N5T package. It measures 1.0 x 0.7mm with a nominal height of 0.40mm. The innovative flow through package design simplifies pcb layout and maximizes signal integrity on high-speed lines.

The combination of small size, low capacitance, and high level of ESD protection makes this device a flexible solution for applications such as camera data lines, MHL, and USB interfaces.

Features

- ◆ ESD protection for high-speed data lines to **IEC 61000-4-2 (ESD) ±25kV (air), ±15kV (contact)**
- ◆ **IEC 61000-4-5 (Lightning) 5A (8/20µs)**
- ◆ **IEC 61000-4-4 (EFT) 40A (5/50ns)**
- ◆ Package design optimized for high speed lines
- ◆ Flow-Through design
- ◆ Very small PCB area: 0.7mm²
- ◆ Protects up to three high-speed lines
- ◆ Backdrive protection on VBus pin
- ◆ Low capacitance: **0.25pF** (typical)
- ◆ Low ESD clamping voltage
- ◆ Solid-state silicon-avalanche technology

Mechanical Characteristics

- ◆ SLP1007N5T 5-pin package (1.0 x 0.7 x 0.40mm)
- ◆ Pb-Free, Halogen Free, RoHS/WEEE Compliant
- ◆ Lead finish: NiPdAu
- ◆ Marking: Marking Code
- ◆ Packaging: Tape and Reel

Applications

- ◆ USB 2.0 & USB 3.0
- ◆ Camera Data Lines
- ◆ MHL

Dimensions

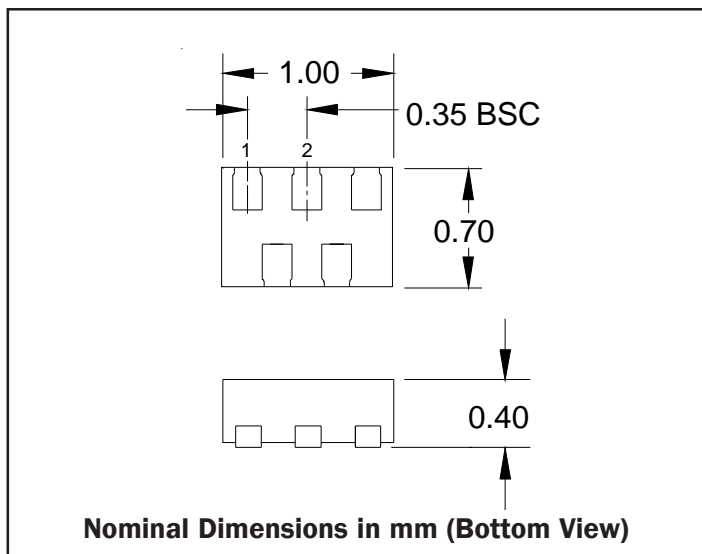

Circuit Diagram

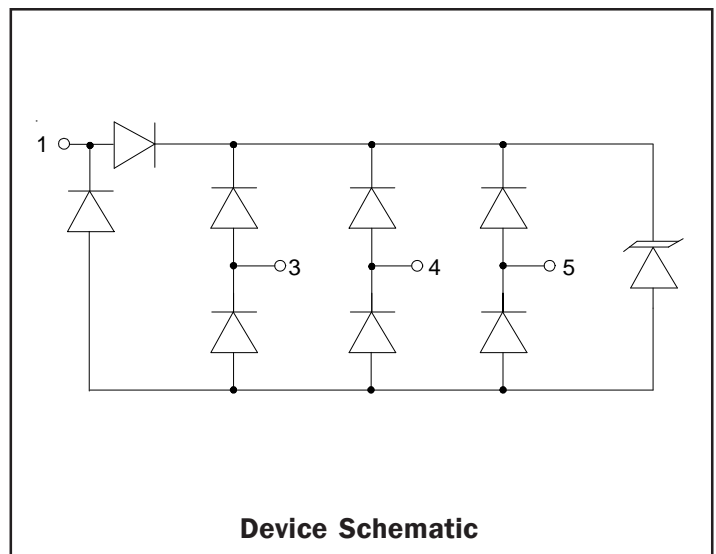

PROTECTION PRODUCTS

Absolute Maximum Rating

Rating	Symbol	Value	Units
Peak Pulse Power (tp = 8/20μs)	P_{pk}	100	Watts
Peak Pulse Current (tp = 8/20μs)	I_{PP}	4	A
ESD per IEC 61000-4-2 (Air) ESD per IEC 61000-4-2 (Contact)	V_{ESD}	+/- 25 +/- 15	kV
Operating Temperature	T_J	-55 to +125	°C
Storage Temperature	T_{STG}	-55 to +150	°C

Electrical Characteristics (T=25°C)

Parameter	Symbol	Conditions	Minimum	Typical	Maximum	Units
Reverse Stand-Off Voltage	V_{RWM}	Any I/O to GND			5	V
Reverse Breakdown Voltage	V_{BR}	$I_t = 1mA$, Any I/O to GND	6.5	9	11	V
Reverse Leakage Current	I_R	$V_{RWM} = 5.0V$, Any I/O to GND		0.005	0.100	μA
Clamping Voltage	V_C	$I_{PP} = 1A$, tp = 8/20μs Any I/O to GND			15	V
Clamping Voltage	V_C	$I_{PP} = 4A$, tp = 8/20μs Any I/O to GND			25	V
Junction Capacitance	C_j	$V_R = 0V$, f = 1MHz, Any I/O to GND		0.25	0.4	pF

PROTECTION PRODUCTS

Typical Characteristics

Non-Repetitive Peak Pulse Power vs. Pulse Time

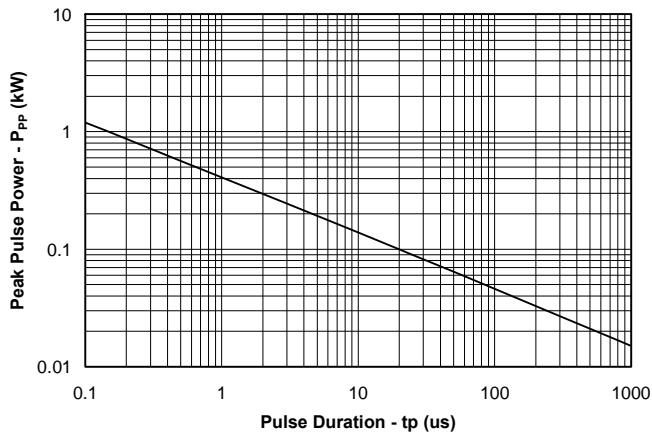

Pulse Waveform

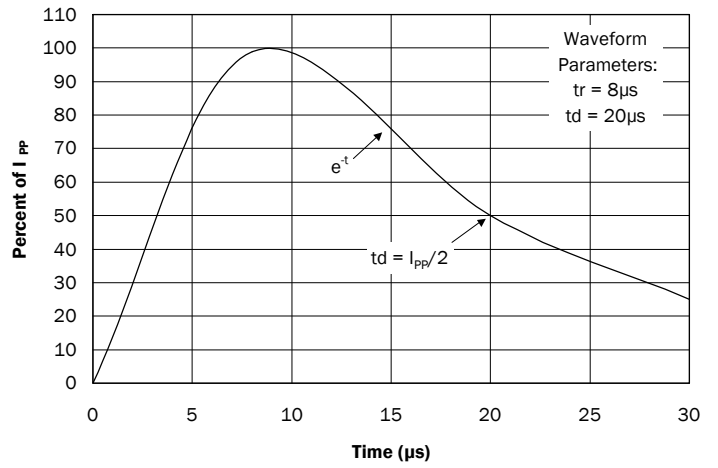

**Clamping Voltage vs. Peak Pulse Current
(Between any I/O and Ground)**

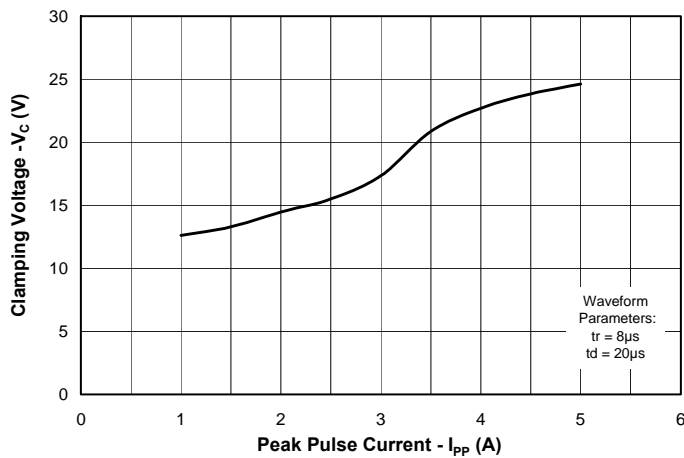

Normalized Capacitance vs. Reverse Voltage

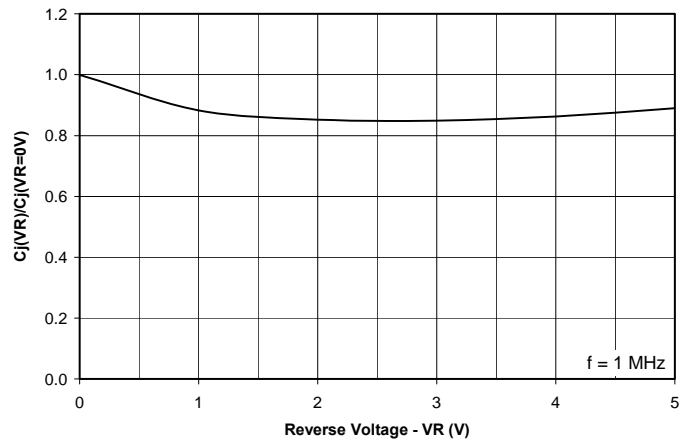

PROTECTION PRODUCTS

Typical Characteristics (Con't)

Insertion Loss S21 - I/O to GND

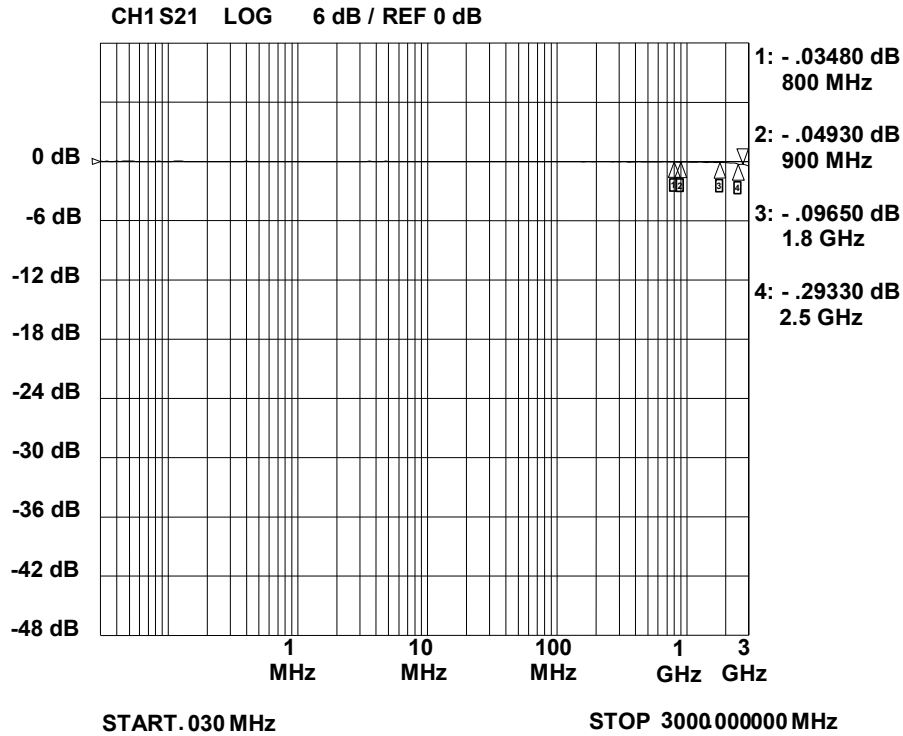

USB 3.0 Eye Pattern with RClamp7522T

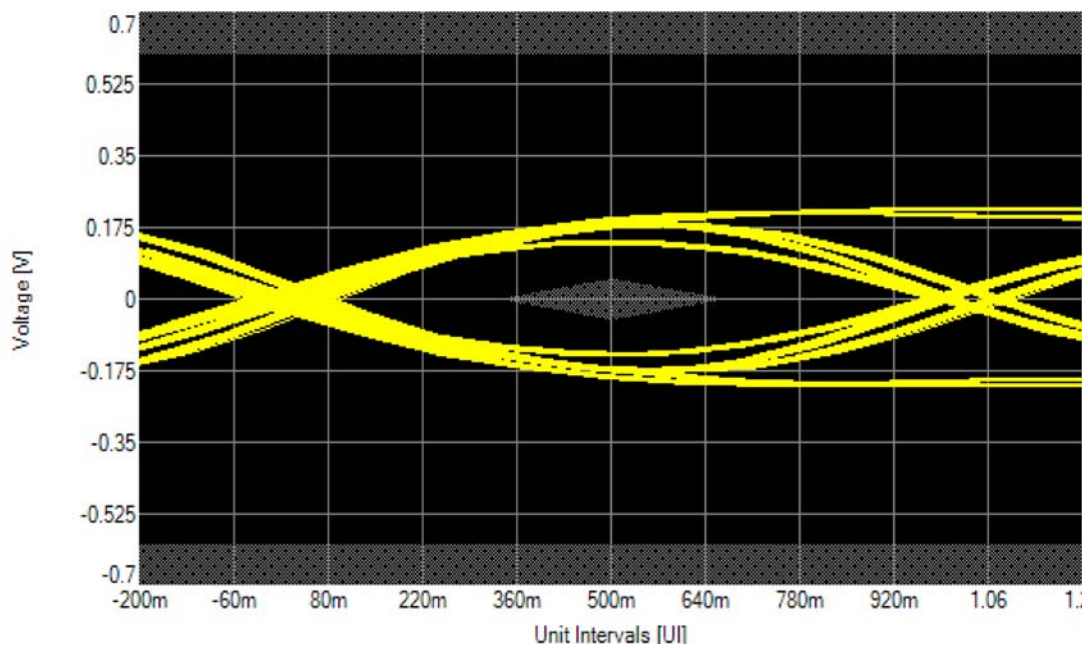

PROTECTION PRODUCTS

Typical Characteristics (Con't)

ESD Clamping (+8kV Contact per IEC 61000-4-2)

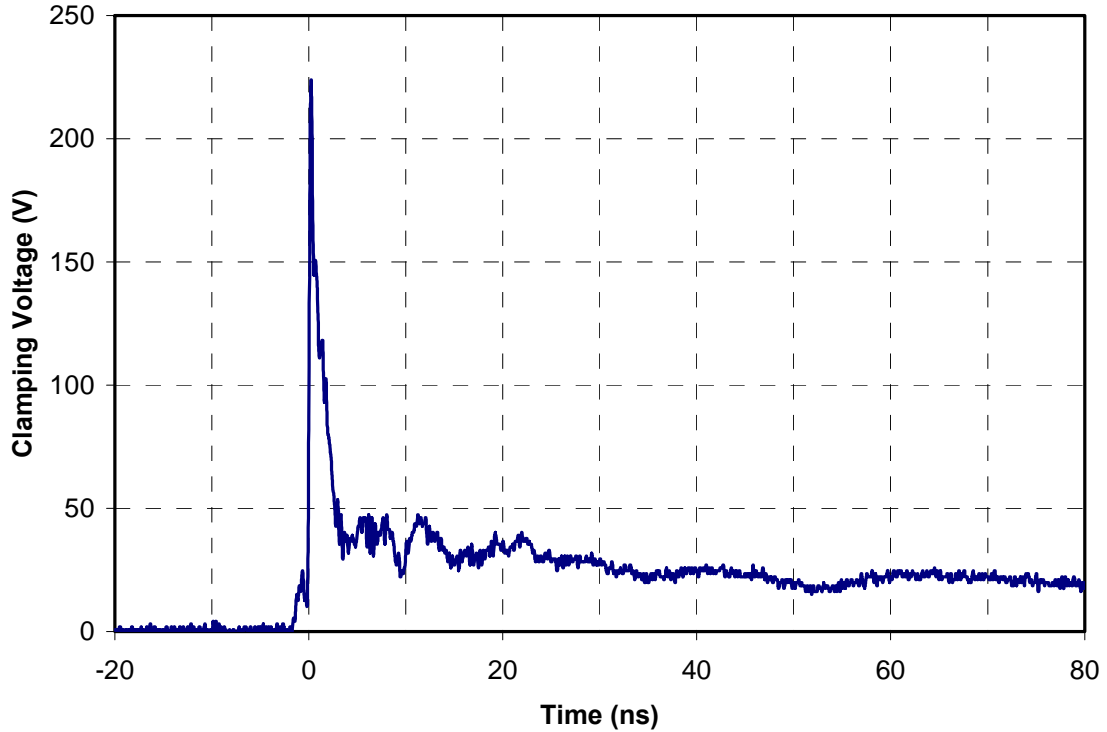

ESD Clamping (-8kV Contact per IEC 61000-4-2)

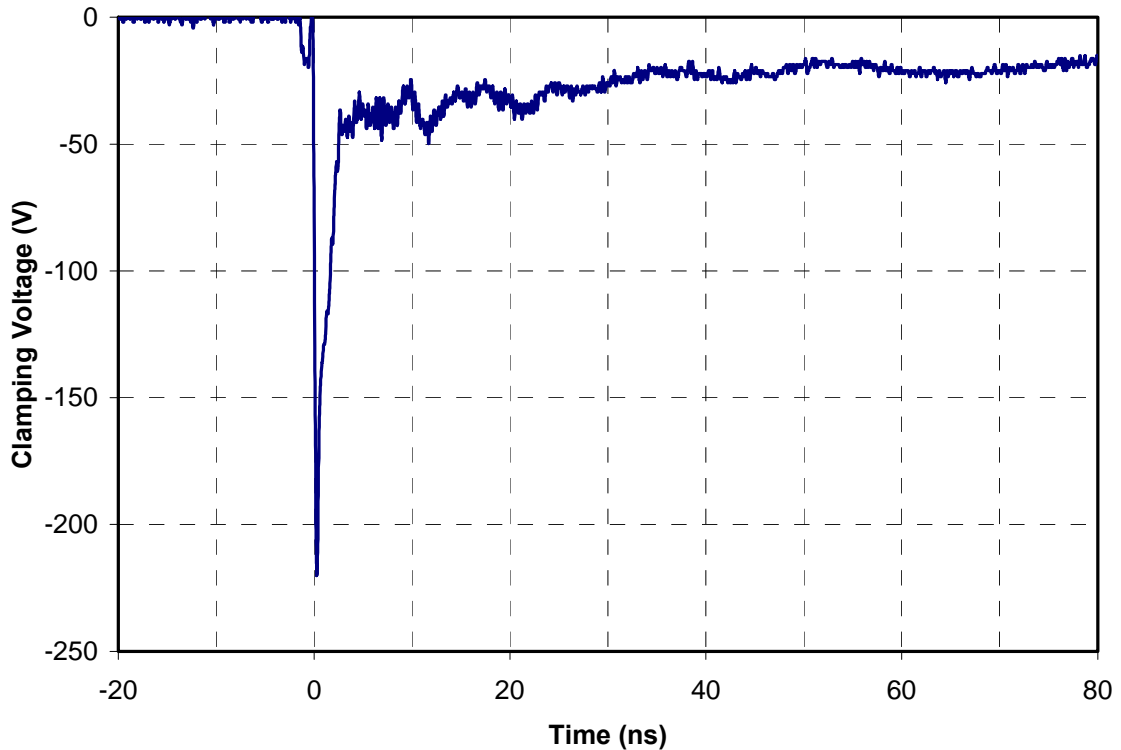

TLP Characteristic

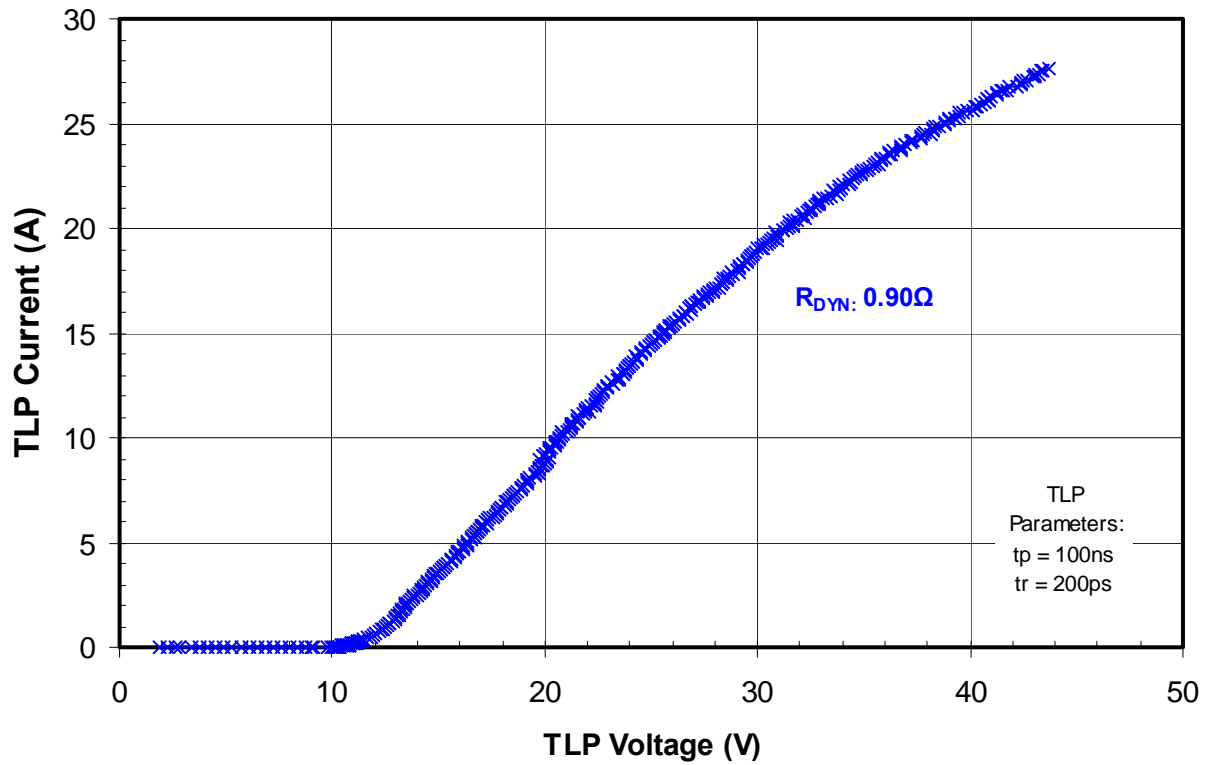

PROTECTION PRODUCTS

Applications Information

Design Recommendations for USB Protection

The RClamp7522T is specifically designed for protection of high-speed interfaces. They present <math><0.40\text{pF}</math> capacitance between any line and ground while being rated to handle >math> \pm 15\text{kV}</math> ESD contact discharges (>math> \pm 25\text{kV}</math> air discharge) as outlined in IEC 61000-4-2. Each device is in a leadless SLP package that occupies a nominal PCB area of 0.7mm^2. The pin configuration is designed such that the traces can be routed straight through the device. The narrow package and flow-through design reduces discontinuity and minimizes impact on signal integrity.

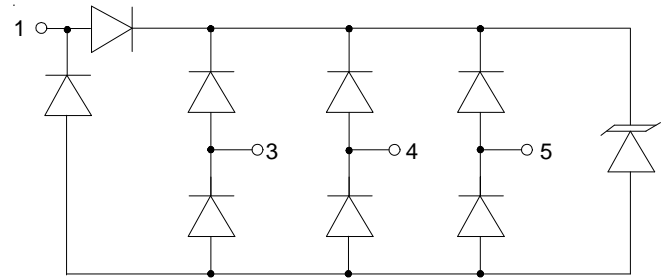

Figure 1 - Circuit Diagram

Design Recommendations for Camera Data Line Protection

Figure 2 shows the recommended pin configuration for protection of camera data lines in mobile phone applications. The camera data lines are connected at pins 3, 4, and 5. The ground connection is made at pin 1. The steering diodes at pin 1 serve to reduce the overall line capacitance.

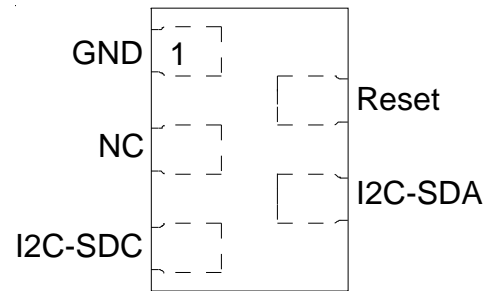

Figure 2 - Pin Configuration (Top View) for Camera Data Line Protection Applications

Design Recommendations for USB Protection

Figure 3 shows the recommended pin configuration for protection of USB data lines. The voltage supply bus is connected at pin 1. The steering diode pair at pin 1 serve as backdrive protection for operation during power down. Data lines are connected at pins 3 and 4. Ground is connected at pin 5. The ground and data line pins are interchangeable since the ground connection contains a steering diode pair for reduced capacitance.

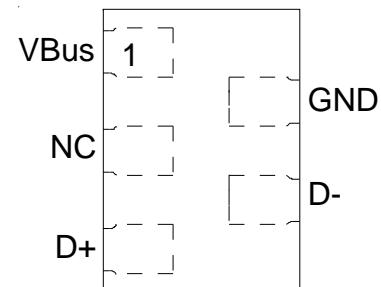

Figure 3 - Pin Configuration (Top View) for USB 2.0 Applications

PROTECTION PRODUCTS

Applications Information

Assembly Guidelines

The small size of this device means that some care must be taken during the mounting process to insure reliable solder joint. The table below provides Semtech's recommended assembly guidelines for mounting this device. The figure at the right details Semtech's recommended aperture based on the below recommendations. Note that these are only recommendations and should serve only as a starting point for design since there are many factors that affect the assembly process. The exact manufacturing parameters will require some experimentation to get the desired solder application.

Assembly Parameter	Recommendation
Solder Stencil Design	Laser cut, Electro-polished
Aperture shape	Rectangular
Solder Stencil Thickness	0.100 mm (0.004")
Solder Paste Type	Type 4 size sphere or smaller
Solder Reflow Profile	Per JEDEC J-STD-020
PCB Solder Pad Design	Non-Solder mask defined
PCB Pad Finish	OSP OR NiAu

Recommended Mounting Pattern

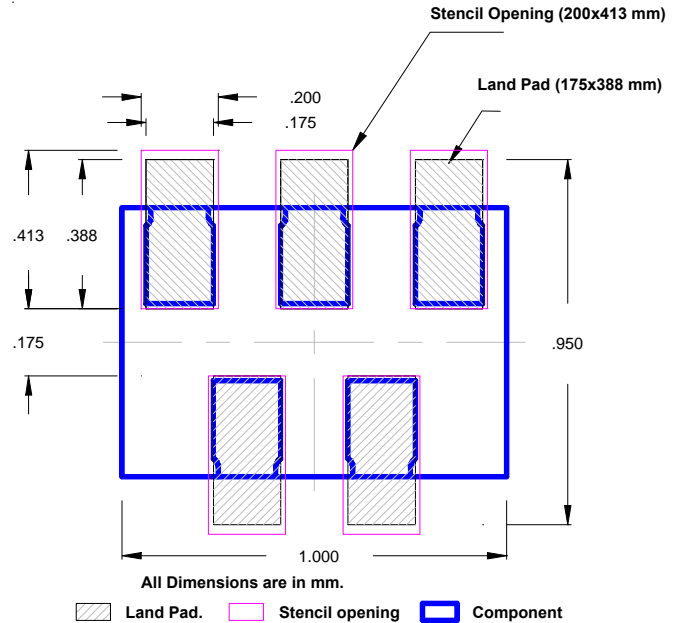

PROTECTION PRODUCTS

Outline Drawing - SLP1007N5T

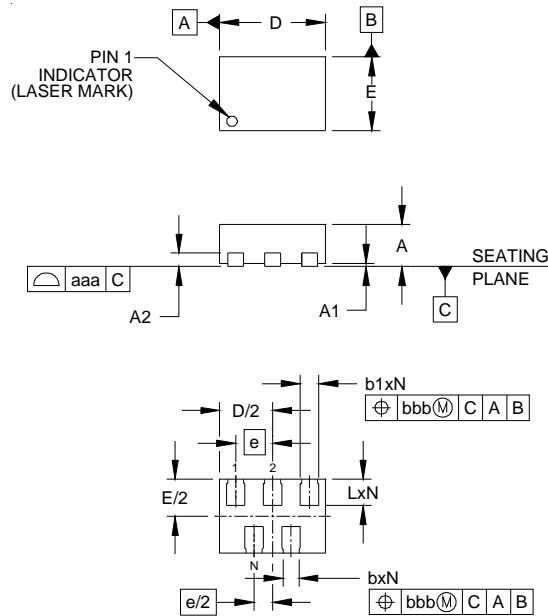

DIMENSIONS			
DIM	MILLIMETERS		
	MIN	NOM	MAX
A	0.37	0.40	0.43
A1	0.00	0.02	0.05
A2	(0.13)		
b	0.125	0.15	0.175
b1	0.15	0.175	0.20
D	0.90	1.00	1.10
E	0.60	0.70	0.80
e	0.35 BSC		
L	0.225	0.25	0.275
N	5		
aaa	0.08		
bbb	0.10		

NOTES:

1. CONTROLLING DIMENSIONS ARE IN MILLIMETERS (ANGLES IN DEGREES).

Land Pattern - SLP1007N5T

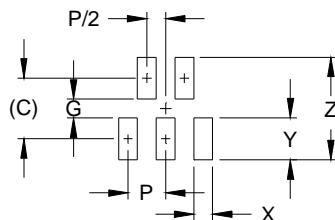

DIMENSIONS	
DIM	MILLIMETERS
C	(0.563)
G	0.175
P	0.35
X	0.175
Y	0.388
Z	0.95

NOTES:

1. CONTROLLING DIMENSIONS ARE IN MILLIMETERS (ANGLES IN DEGREES).
2. THIS LAND PATTERN IS FOR REFERENCE PURPOSES ONLY. CONSULT YOUR MANUFACTURING GROUP TO ENSURE YOUR COMPANY'S MANUFACTURING GUIDELINES ARE MET.

PROTECTION PRODUCTS

Marking Codes

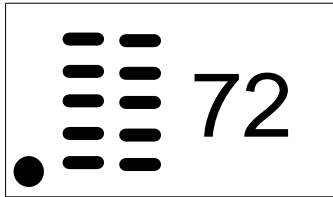

Ordering Information

Part Number	Qty per Reel	Reel Size
RClamp7522T.TNT	10,000	7 Inch

RailClamp and RClamp are trademarks of Semtech Corporation.

Notes:

Marking will also include line matrix date code

Carrier Tape Specification

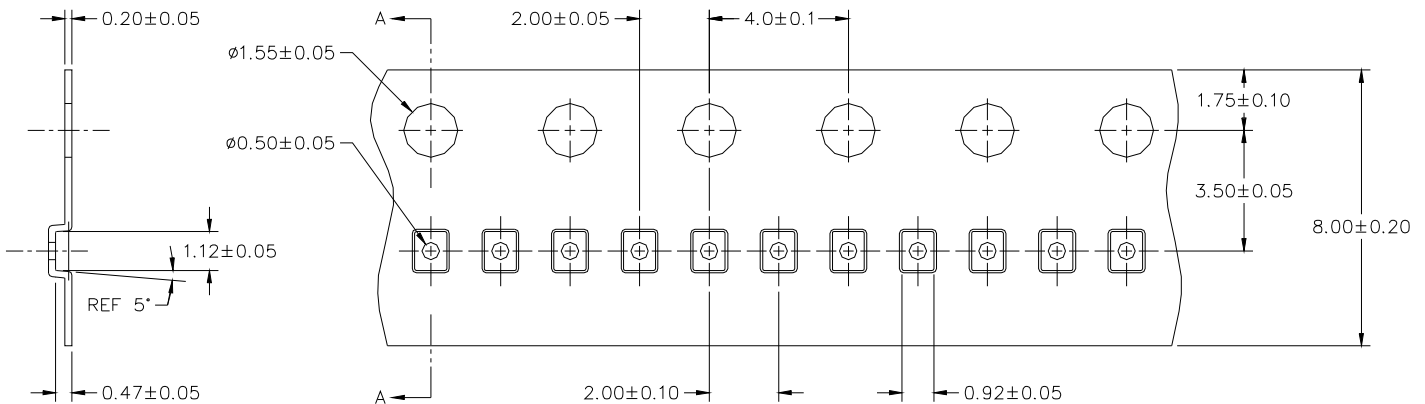

SECTION A-A

Device Orientation in Tape

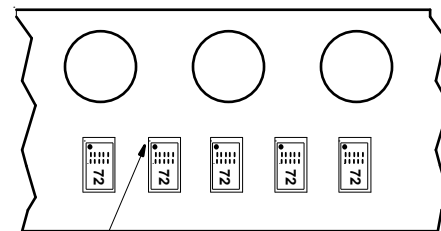

Pin 1 Location
(Towards Sprocket Holes)

Contact Information for Semtech International AG

Taiwan Branch
Tel: 886-2-2748-3380
Fax: 886-2-2748-3390

Korea Branch
Tel: 82-2-527-4377
Fax: 82-2-527-4376

Shanghai Office
Tel: 86-21-6391-0830
Fax: 86-21-6391-0831

Semtech Switzerland GmbH
Tel: 81-3-6408-0950
Japan Branch
Fax: 81-3-6408-0951

Semtech Limited (U.K.)
Tel: 44-1794-527-600
Fax: 44-1794-527-601

Semtech France SARL
Tel: 33-(0)169-28-22-00
Fax: 33-(0)169-28-12-98

Semtech Germany GmbH
Tel: 49-(0)8161-140-123
Fax: 49-(0)8161-140-124

Semtech International AG is a wholly-owned subsidiary of Semtech Corporation, which has its headquarters in the U.S.A.