

PROTECTION PRODUCTS - RailClamp®

Description

RailClamp® TVS arrays are low capacitance ESD protection devices designed to protect high speed data interfaces. The RClamp®1255P provides dedicated surge and ESD protection for uUSB ports. It is designed to replace multiple discrete components in portable applications. This device features low capacitance TVS diodes for protection of the USB data (DP, DM) and USB ID pins operating up to +/- 4 volts. These diodes provide ESD protection to ±10kV contact discharge per IEC 61000-4-2. Loading capacitance on these lines is <0.50pF. An integrated 12 volt TVS diode is used for protection of the USB voltage bus. The VBus TVS is designed with a high surge current capability of 100A (tp=8/20us) and low clamping voltage.

The RClamp1255P is in a 6-pin SLP2018P6 package. It measures 2.0 x 1.8mm with a nominal height of 0.57mm. This highly integrated device requires less board space than existing solutions.

The combination of small size, low capacitance, and high level of surge and ESD protection makes this device a flexible solution for protection of USB interfaces in mobile phones, laptops, and other portable electronics.

Features

- ◆ ESD and surge protection for USB Voltage Bus to **IEC 61000-4-2 (ESD) ±30kV (air), ±30kV (contact)**
IEC 61000-4-5 (Lightning) 100A (8/20µs)
IEC 61000-4-4 (EFT) 40A (5/50ns)
- ◆ ESD protection for USB data lines to **IEC 61000-4-2 (ESD) ±15kV (air), ±10kV (contact)**
- ◆ Protects USB DP, DM, and ID Pins operating up to +/- 4V
- ◆ Protects USB VBus operating up to 12V
- ◆ Low capacitance (<0.50pF) on DP, DM, and ID Pins
- ◆ Low clamping voltage
- ◆ Low dynamic resistance on DP, DM, and ID Pins
- ◆ Solid-state silicon-avalanche technology

Mechanical Characteristics

- ◆ SLP2018P6 6L package
- ◆ Pb-Free, Halogen Free, RoHS/WEEE Compliant
- ◆ Nominal Dimensions: 2.0 x 1.8 x 0.57 mm
- ◆ Lead Finish: NiPdAu
- ◆ Molding compound flammability rating: UL 94V-0
- ◆ Marking : Marking Code + Date Code
- ◆ Packaging : Tape and Reel

Applications

- ◆ USB 2.0
- ◆ USB OTG
- ◆ uUSB

Circuit Diagram

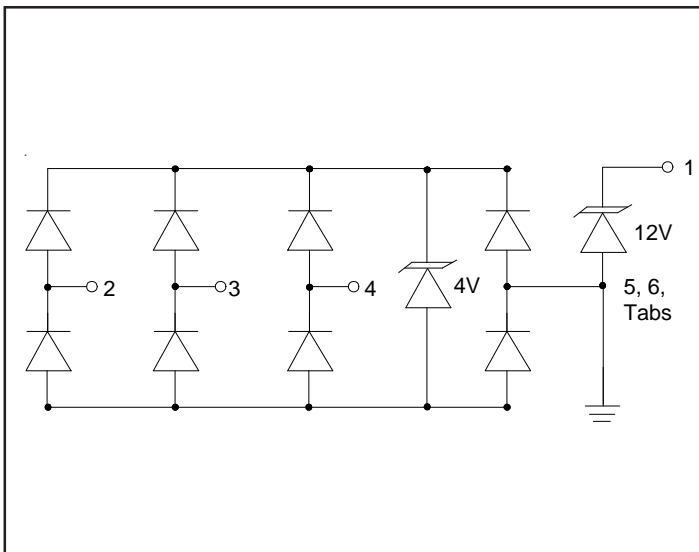

Pin Configuration (Top View)

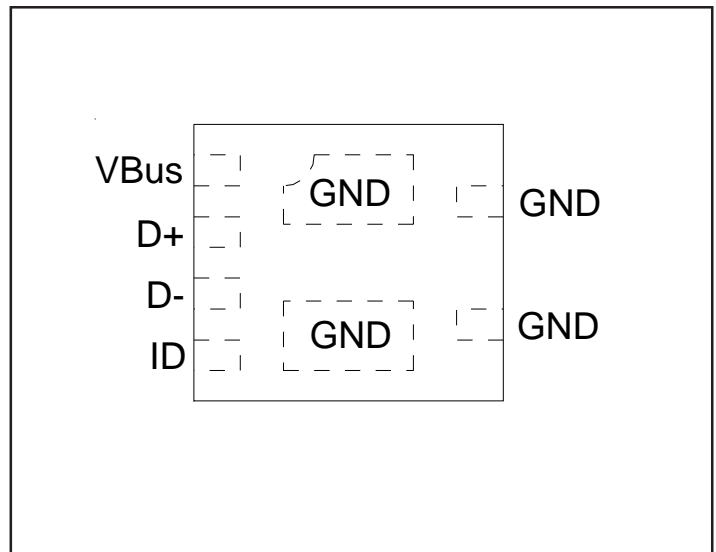

PROTECTION PRODUCTS
Absolute Maximum Rating

Rating	Symbol	Value	Units
DP, DM, USB ID TVS			
Peak Pulse Power (tp = 8/20μs)	P_{pk}	40	Watts
Peak Pulse Current (tp = 8/20μs)	I_{pp}	3	A
ESD per IEC 61000-4-2 (Air) ESD per IEC 61000-4-2 (Contact)	V_{ESD}	±15 ±10	kV
Operating Temperature	T_J	-55 to +125	°C
Storage Temperature	T_{STG}	-55 to +150	°C
VBus TVS			
Peak Pulse Power (tp = 8/20μs)	P_{pk}	2500	Watts
Peak Pulse Current (tp = 8/20μs)	I_{pp}	100	A
ESD per IEC 61000-4-2 (Air) ESD per IEC 61000-4-2 (Contact)	V_{ESD}	±30 ±30	kV
Operating Temperature	T_J	-55 to +125	°C
Storage Temperature	T_{STG}	-55 to +150	°C

Electrical Characteristics (T=25°C)

VBus TVS (Pin 1)						
Parameter	Symbol	Conditions	Minimum	Typical	Maximum	Units
Reverse Stand-Off Voltage	V_{RWM}	Pin 1 to GND			12	V
Reverse Breakdown Voltage	V_{BR}	$I_t = 1mA$, Pin 1 to GND	13.5	14.5	16.5	V
Reverse Leakage Current	I_R	$V_{RWM} = 12V$ Pin 1 to GND			0.300	μA
Forward Voltage	V_F	$I_f = 10mA$ GND to Pin 1	0.6	0.7	1.0	V
Clamping Voltage	V_C	$I_{pp} = 30A$, tp = 8/20μs Pin 1 to Ground		15.5	18	V
Clamping Voltage	V_C	$I_{pp} = 100A$, tp = 8/20μs Pin 1 to Ground		18.5	25	V
Junction Capacitance	C_J	$V_R = 0V$, f = 1MHz Pin 1 to GND		1950	2500	pF

PROTECTION PRODUCTS
Electrical Characteristics (T=25°C)

DM, DP, USB ID (Pins 2, 3, 4)						
Parameter	Symbol	Conditions	Minimum	Typical	Maximum	Units
Reverse Stand-Off Voltage	V_{RWM}	Pin 2, 3, 4 to GND			4	V
Reverse Breakdown Voltage	V_{BR}	$I_t = 1mA$, Pin 2, 3, 4 to GND	4.5	5.7	6.3	V
Reverse Leakage Current	I_R	$V_{RWM} = 2.0V$, Pin 2, 3, 4 to GND		<0.005	0.020	μA
Reverse Leakage Current	I_R	$V_{RWM} = 4.0V$, Pin 2, 3, 4 to GND		0.005	0.100	μA
Clamping Voltage	V_C	$I_{pp} = 1A$, $t_p = 8/20\mu s$ Pin 2, 3, 4 to GND			10.5	V
Clamping Voltage	V_C	$I_{pp} = 3A$, $t_p = 8/20\mu s$ Pin 2, 3, 4 to GND			12.5	V
Dynamic Resistance ¹	R_{Dyn}	$I_{pp} = 4A$ to $I_{pp} = 16A$		0.70		Ohms
		$I_{pp} = -4A$ to $I_{pp} = -16A$		0.70		Ohms
Junction Capacitance	C_j	$V_R = 0V$, $f = 1MHz$, Pin 2, 3, 4 to GND		0.35	0.50	pF

Notes

1)Transmission Line Pulse Test (TLP) Settings: $t_p = 100ns$, $t_r = 0.2ns$, I_{TLP} and V_{TLP} averaging window: $t_1 = 70ns$ to $t_2 = 90ns$

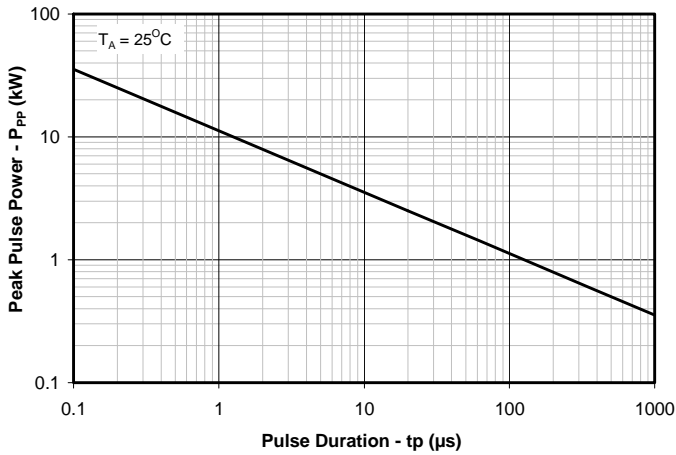
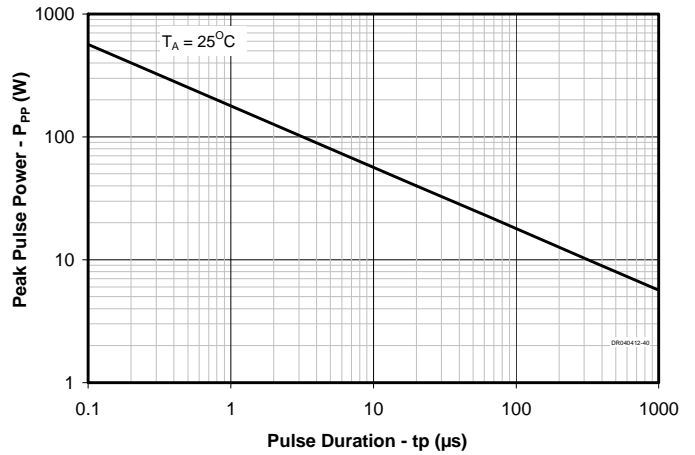
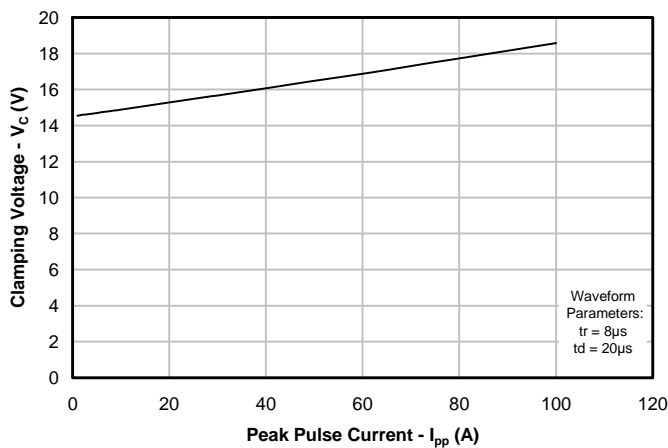
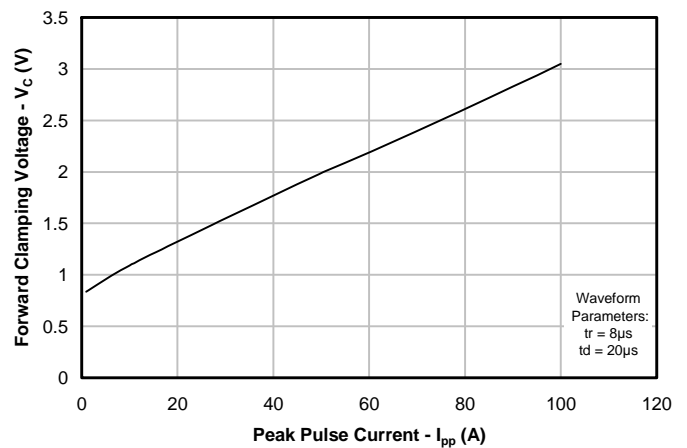
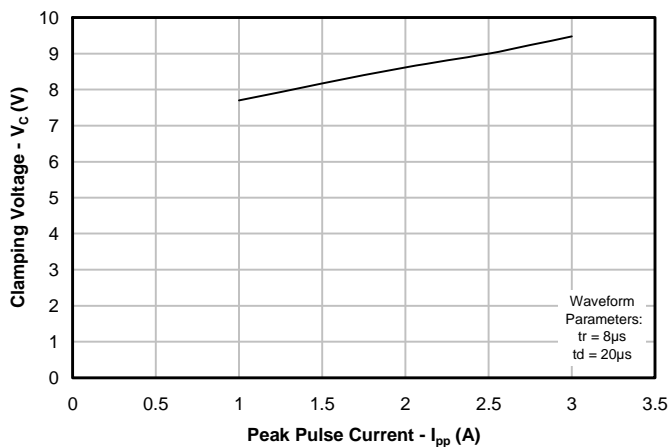
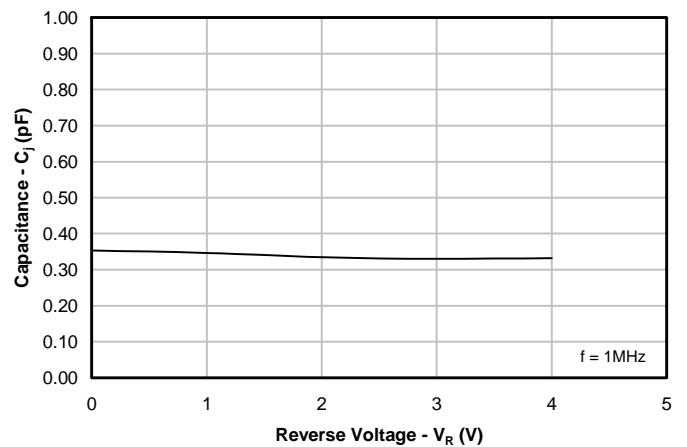
PROTECTION PRODUCTS
Typical Characteristics
**Non-Repetitive Peak Pulse Power vs. Pulse Time
VBus Pin (Pin 1)**

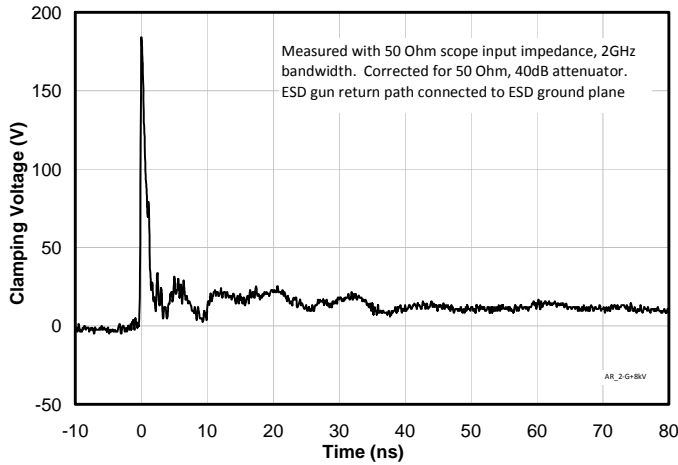
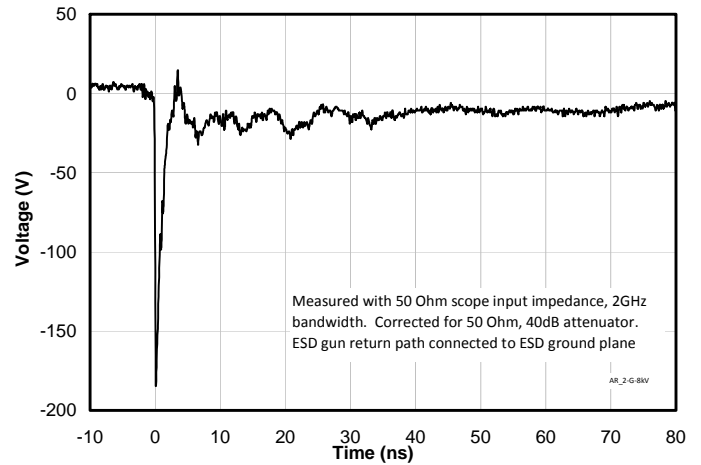
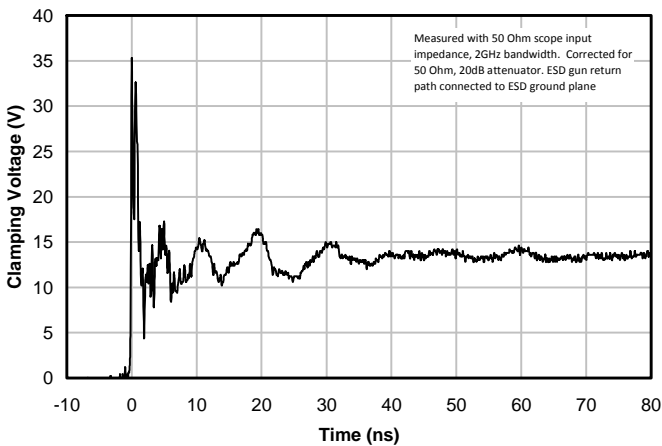
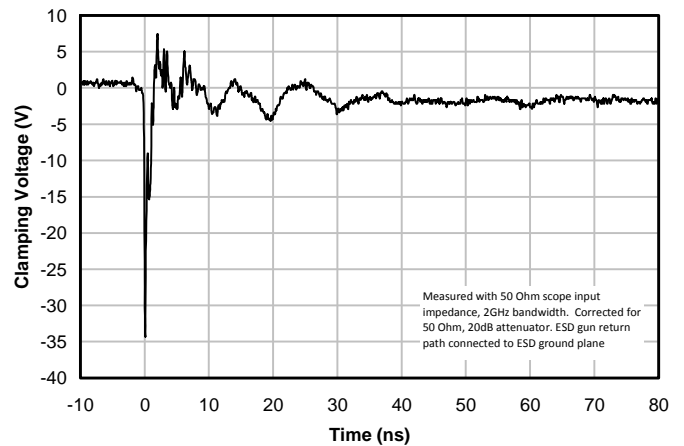
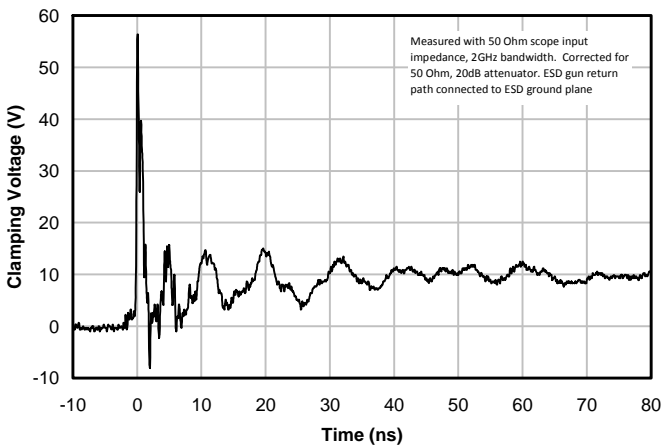
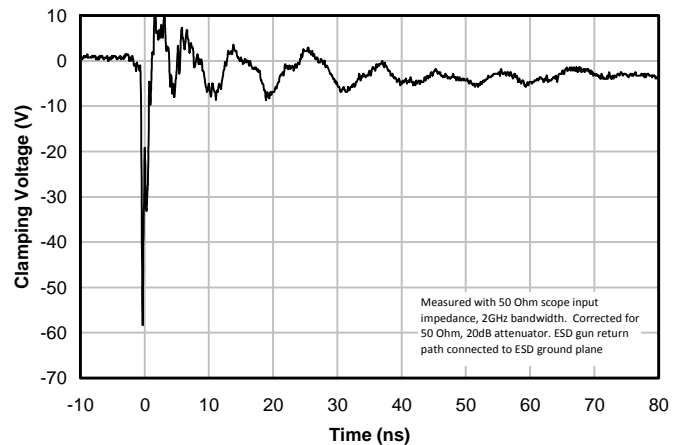
**Non-Repetitive Peak Pulse Power vs. Pulse Time
D+, D-, ID Pins (Pins 2, 3, 4)**

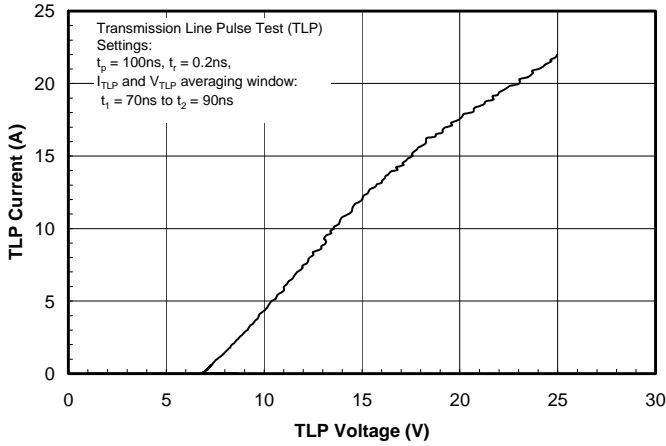
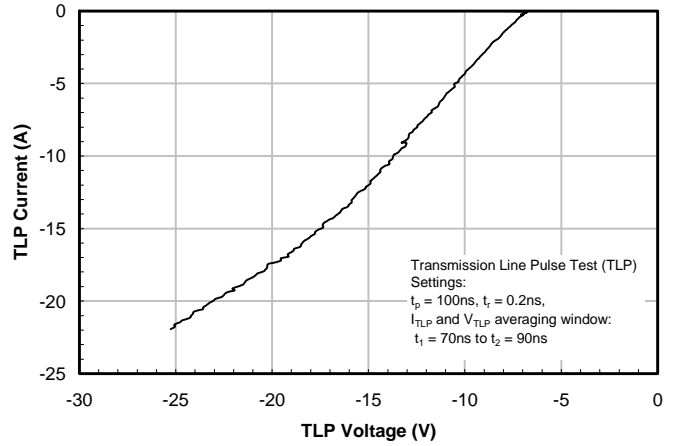
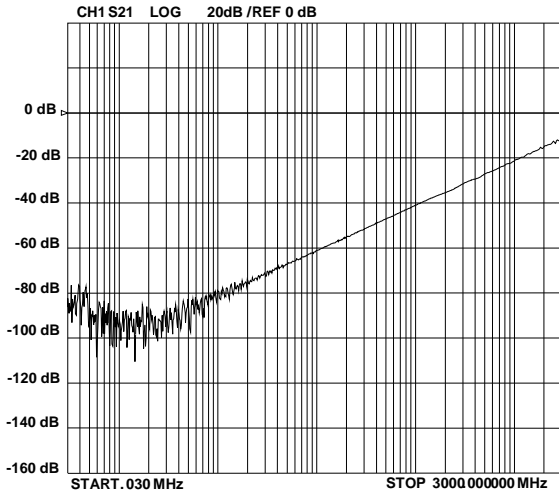
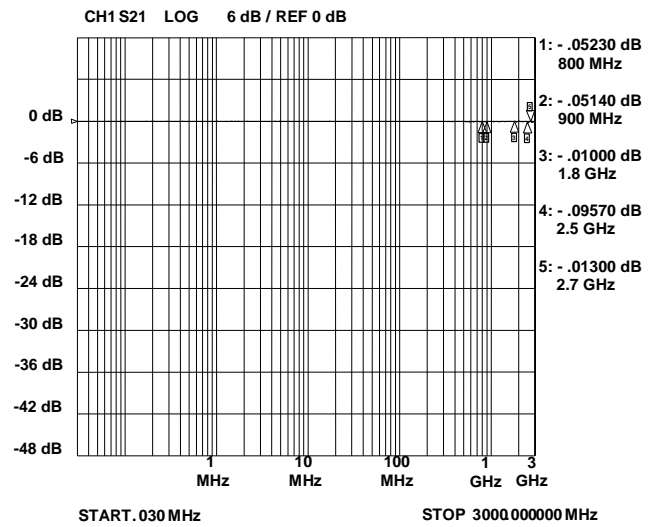
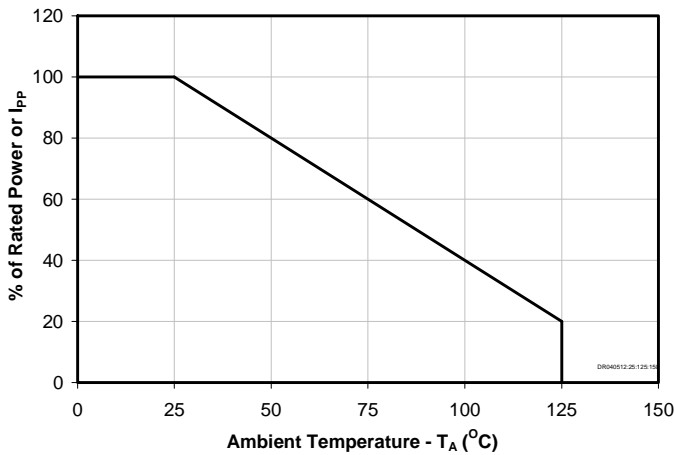
**Clamping Voltage vs. Peak Pulse Current
VBus Pin (Pin 1)**

**Forward Clamping Voltage vs. Peak Pulse Current
VBus Pin (Pin 1)**

**Clamping Voltage vs. Peak Pulse Current
D+, D-, ID Pins (Pins 2, 3, 4)**

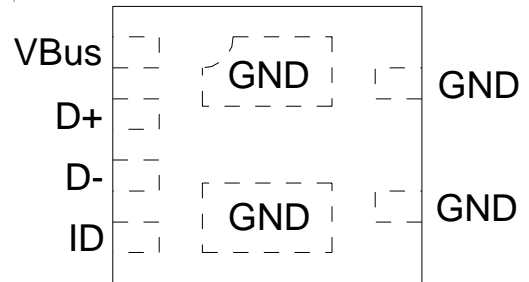
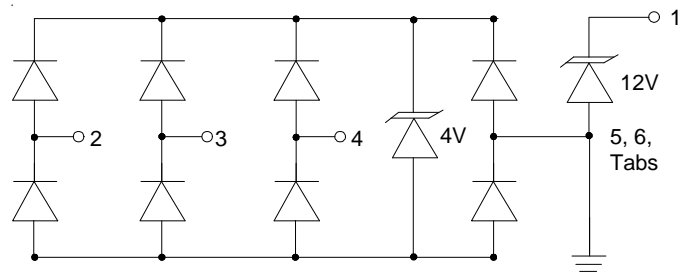
**Capacitance vs. Reverse Voltage
D+, D-, ID Pins (Pins 2, 3, 4)**

PROTECTION PRODUCTS
Typical Characteristics
**ESD Clamping (+8kV Contact per IEC 61000-4-2)
D+, D-. ID Pins (Pins 2, 3, 4)**

**ESD Clamping (-8kV Contact per IEC 61000-4-2)
D+, D-. ID Pins (Pins 2, 3, 4)**

**ESD Clamping (+8kV Contact per IEC 61000-4-2)
VBus Pin (Pin 1)**

**ESD Clamping (-8kV Contact per IEC 61000-4-2)
VBus Pin (Pin 1)**

**ESD Clamping +30kV Contact per IEC 61000-4-2)
VBus Pin (Pin 1)**

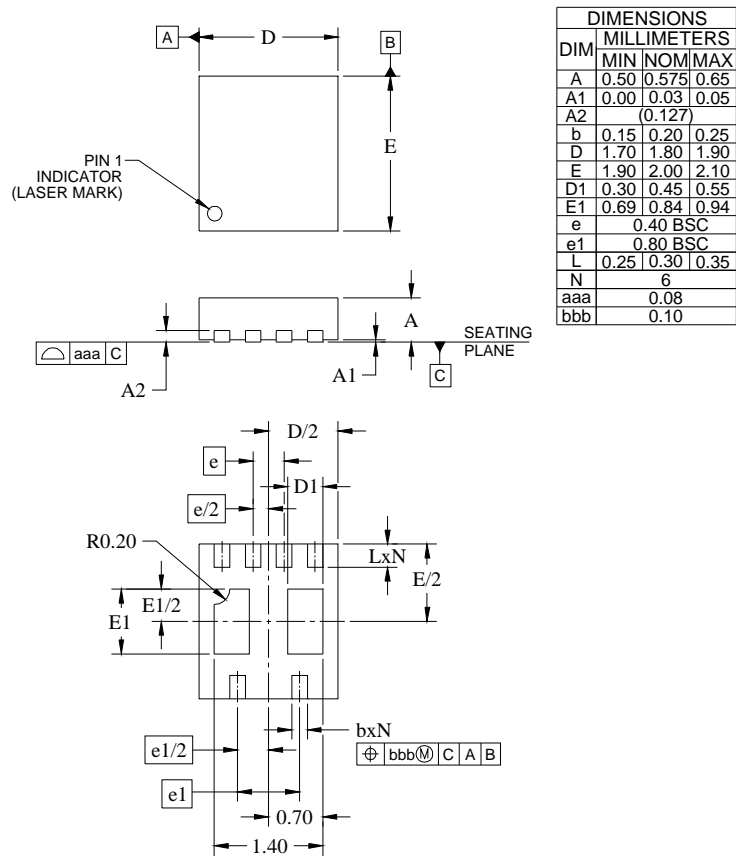
**ESD Clamping -30kV Contact per IEC 61000-4-2)
VBus Pin (Pin 1)**

PROTECTION PRODUCTS
Typical Characteristics
**TLP Characteristic (Positive Pulse)
D+, D-. ID Pins (Pins 2, 3, 4)**

**TLP Characteristic (Negative Pulse)
D+, D-. ID Pins (Pins 2, 3, 4)**

**Analog Crosstalk
D+, D-. ID Pins (Pins 2, 3, 4)**

**Typical Insertion Loss S21
D+, D-. ID Pins (Pins 2, 3, 4)**

Non-Repetitive Peak Pulse Power Derating Curve

PROTECTION PRODUCTS
Applications Information
Device Connection and Layout Options for Protecting One USB Port

The RClamp1255P is optimized for protection of USB ports. Low capacitance protection is provided for the USB data (DM, DP) and USB ID pins. The maximum capacitance on these lines is <math><0.5\text{pF}</math> for maximum signal integrity. USB Data and ID lines are connected at pins 2, 3, and 4. These inputs are referenced to an internal 4 volt TVS protection device. When the voltage on these lines exceed 4 volts, the TVS will conduct. Pin 1 is connected to the USB voltage bus (VBus). This device will conduct when the voltage on the bus exceeds 12 volts. Ground is provided at pins 5, 6, and the center tabs. Multiple micro vias connected to ground are recommended for best ESD performance. This will reduce parasitic inductance in the ground path and minimize the clamping voltage seen by the protected device.

Figure 1 - Pin Configuration (Top View)

Figure 2 - Schematic

PROTECTION PRODUCTS
Outline Drawing - SLP2018P6

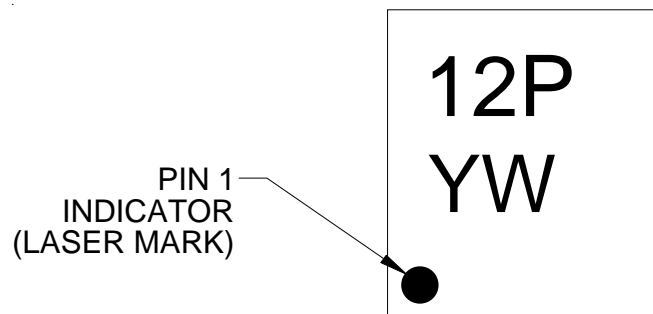
NOTES:
1. CONTROLLING DIMENSIONS ARE IN MILLIMETERS (ANGLES IN DEGREES).

Marking

YW = Date Code

PROTECTION PRODUCTS

Ordering Information

Part Number	Qty per Reel	Reel Size
RClamp1255P.TGT	10,000	13 Inch

RailClamp and RClamp are trademarks of Semtech Corporation.

Carrier Tape Specification

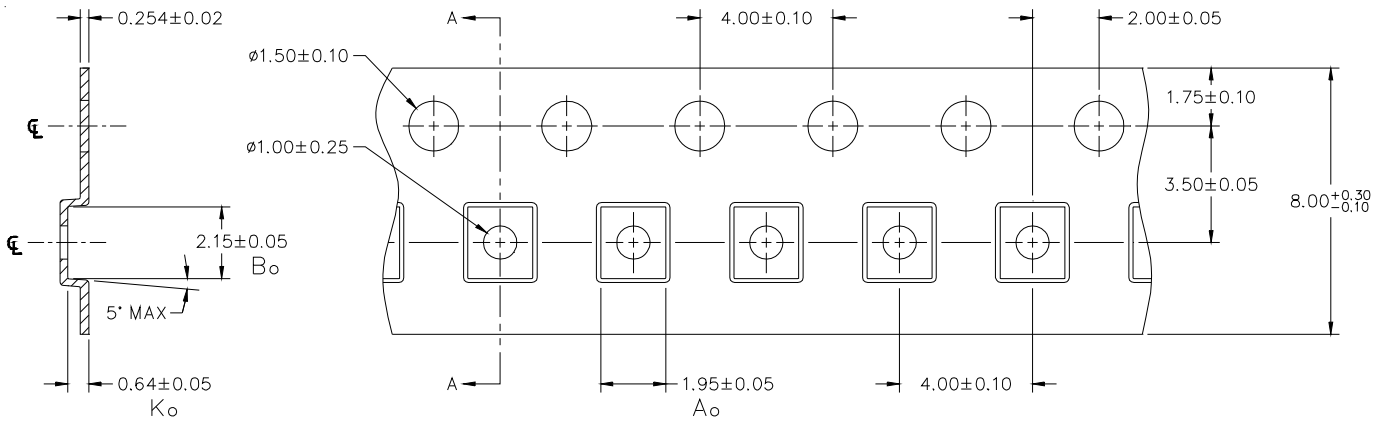

SECTION A-A

NOTE: ALL DIMENSIONS IN MILLIMETERS UNLESS OTHERWISE SPECIFIED.

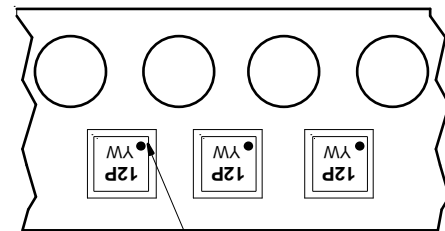

Pin 1 Location
(Towards Sprocket Holes)

Device Orientation in Tape

Contact Information

Semtech Corporation
 Protection Products Division
 200 Flynn Road, Camarillo, CA 93012
 Phone: (805)498-2111 FAX (805)498-3804