

# SKKT 106, SKKT 106B, SKKH 106



**SEMIPACK<sup>®</sup> 1**

## Thyristor / Diode Modules

**SKKT 106**

**SKKT 106B**

**SKKH 106**

### Features

- Heat transfer through aluminium oxide ceramic isolated metal baseplate
- Hard soldered joints for high reliability
- UL recognized, file no. E 63 532

### Typical Applications\*

- DC motor control (e. g. for machine tools)
- AC motor soft starters
- Temperature control (e. g. for ovens, chemical processes)
- Professional light dimming (studios, theaters)

1) See the assembly instructions

$V_{RSM}$ V	$V_{RRM}, V_{DRM}$ V	$I_{TRMS} = 180$ A (maximum value for continuous operation) $I_{TAV} = 106$ A (sin. 180; $T_c = 85$ °C)		
900	800	SKKT 106/08E	SKKT 106B08E	SKKH 106/08E
1300	1200	SKKT 106/12E	SKKT 106B12E	SKKH 106/12E
1500	1400	SKKT 106/14E	SKKT 106B14E	SKKH 106/14E
1700	1600	SKKT 106/16E	SKKT 106B16E	SKKH 106/16E
1900	1800	SKKT 106/18E	SKKT 106B18E	SKKH 106/18E

Symbol	Conditions	Values	Units
$I_{TAV}$	sin. 180; $T_c = 85$ (100) °C;	106 (78 )	A
$I_D$	P3/180F; $T_a = 35$ °C; B2 / B6 P16/200F; $T_a = 35$ °C; B2 / B6	145 / 180 190 / 260	A
$I_{RMS}$	P3/180F; $T_a = 35$ °C; W1 / W3	200 / 3 * 140	A
$I_{TSM}$	$T_{vj} = 25$ °C; 10 ms $T_{vj} = 130$ °C; 10 ms	2250 1900	A
$i^2t$	$T_{vj} = 25$ °C; 8,3 ... 10 ms $T_{vj} = 130$ °C; 8,3 ... 10 ms	25000 18000	A <sup>2</sup> s
$V_T$	$T_{vj} = 25$ °C; $I_T = 300$ A	max. 1,65	V
$V_{T(TO)}$	$T_{vj} = 130$ °C	max. 0,9	V
$r_T$	$T_{vj} = 130$ °C	max. 2	mΩ
$I_{DD}; I_{RD}$	$T_{vj} = 130$ °C; $V_{RD} = V_{RRM}; V_{DD} = V_{DRM}$	max. 20	mA
$t_{gd}$	$T_{vj} = 25$ °C; $I_G = 1$ A; $di_G/dt = 1$ A/μs	1	μs
$t_{gr}$	$V_D = 0,67 * V_{DRM}$	2	μs
$(di/dt)_{cr}$	$T_{vj} = 130$ °C	max. 150	A/μs
$(dv/dt)_{cr}$	$T_{vj} = 130$ °C	max. 1000	V/μs
$t_q$	$T_{vj} = 130$ °C	100	μs
$I_H$	$T_{vj} = 25$ °C; typ. / max.	150 / 250	mA
$I_L$	$T_{vj} = 25$ °C; $R_G = 33$ Ω; typ. / max.	300 / 600	mA
$V_{GT}$	$T_{vj} = 25$ °C; d.c.	min. 3	V
$I_{GT}$	$T_{vj} = 25$ °C; d.c.	min. 150	mA
$V_{GD}$	$T_{vj} = 130$ °C; d.c.	max. 0,25	V
$I_{GD}$	$T_{vj} = 130$ °C; d.c.	max. 6	mA
$R_{th(j-c)}$	cont.; per thyristor / per module	0,28 / 0,14	K/W
$R_{th(j-c)}$	sin. 180; per thyristor / per module	0,3 / 0,15	K/W
$R_{th(j-c)}$	rec. 120; per thyristor / per module	0,32 / 0,16	K/W
$R_{th(c-s)}$	per thyristor / per module	0,2 / 0,1	K/W
$T_{vj}$		- 40 ... + 130	°C
$T_{stg}$		- 40 ... + 125	°C
$V_{isol}$	a. c. 50 Hz; r.m.s.; 1 s / 1 min.	3600 / 3000	V~
$M_s$	to heatsink	5 ± 15 % <sup>1)</sup>	Nm
$M_t$	to terminal	3 ± 15 %	Nm
$a$		5 * 9,81	m/s <sup>2</sup>
$m$	approx.	95	g
Case	SKKT	A 46	
	SKKT ...B	A 48	
	SKKH	A 47	



**SKKT**

**SKKH**

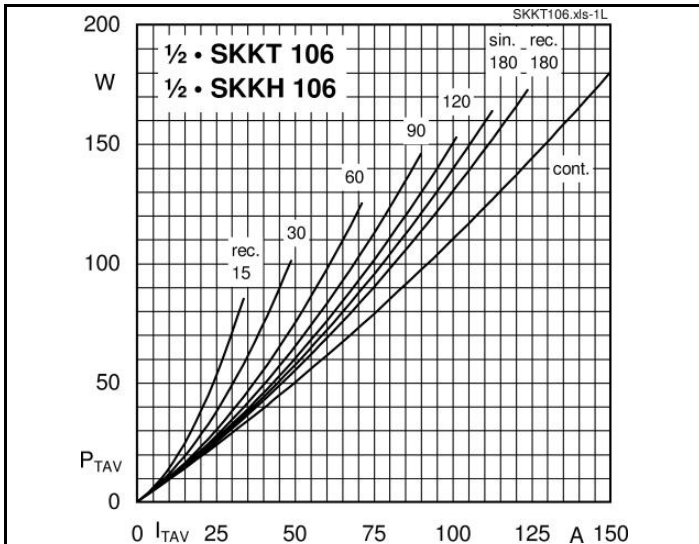

Fig. 1L Power dissipation per thyristor vs. on-state current

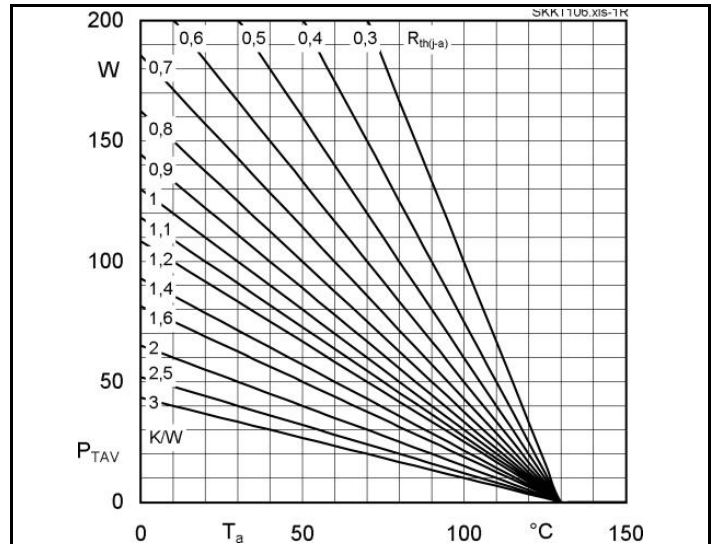

Fig. 1R Power dissipation per thyristor vs. ambient temp.

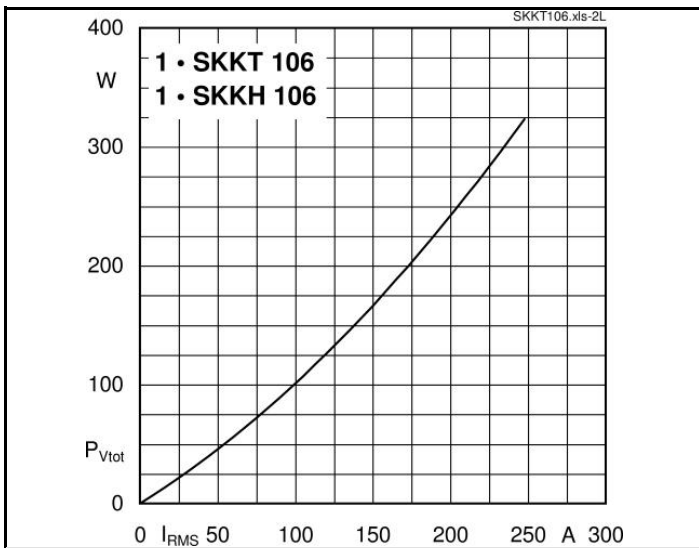

Fig. 2L Power dissipation per module vs. rms current

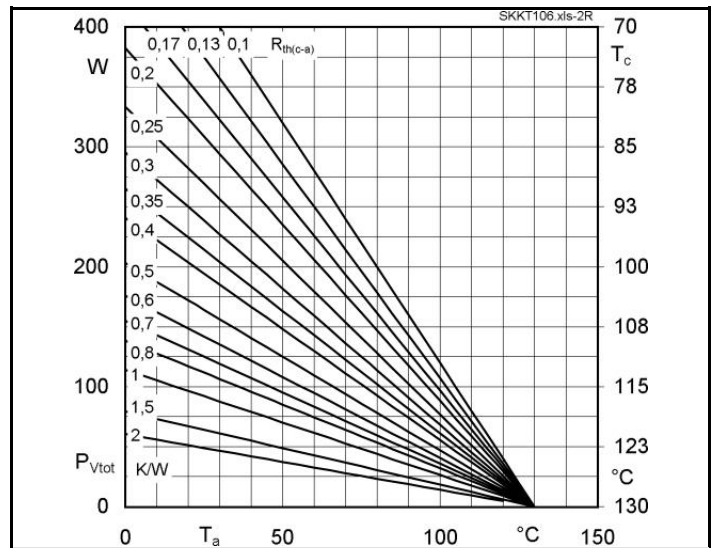

Fig. 2R Power dissipation per module vs. case temp.

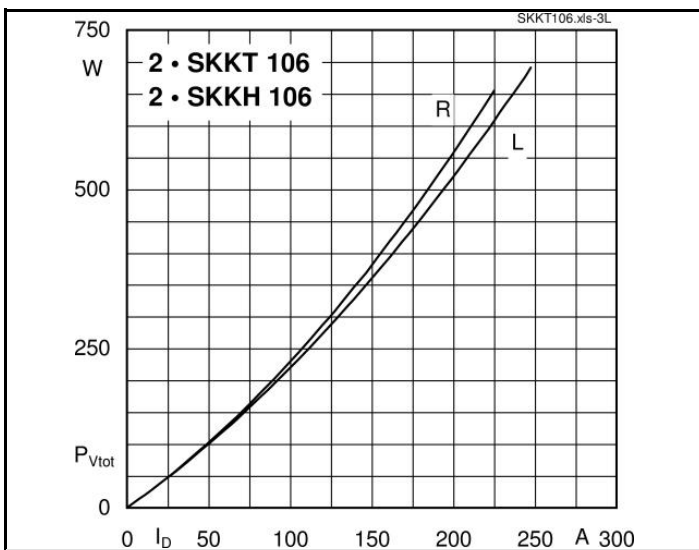

Fig. 3L Power dissipation of two modules vs. direct current

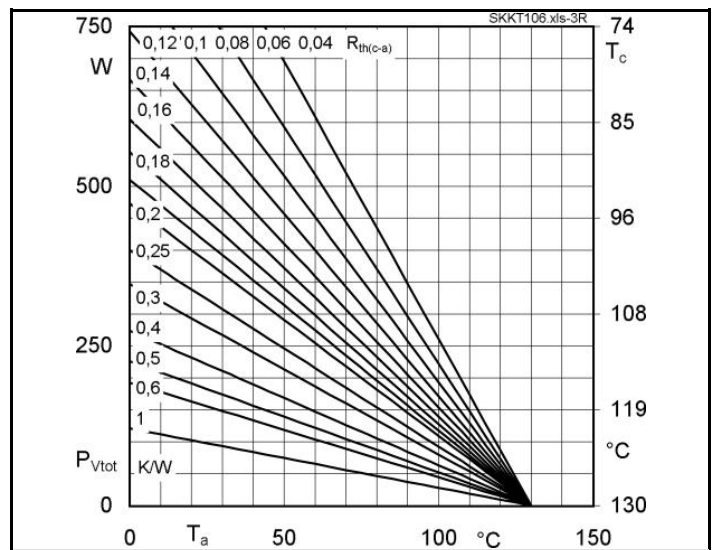
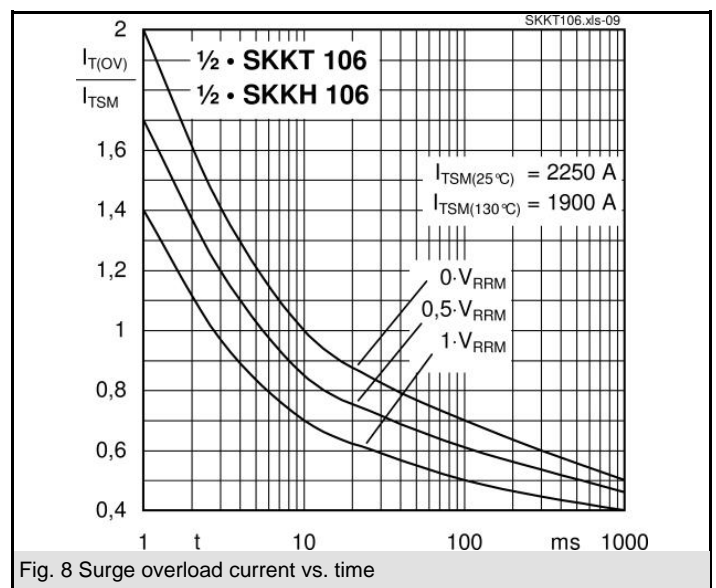
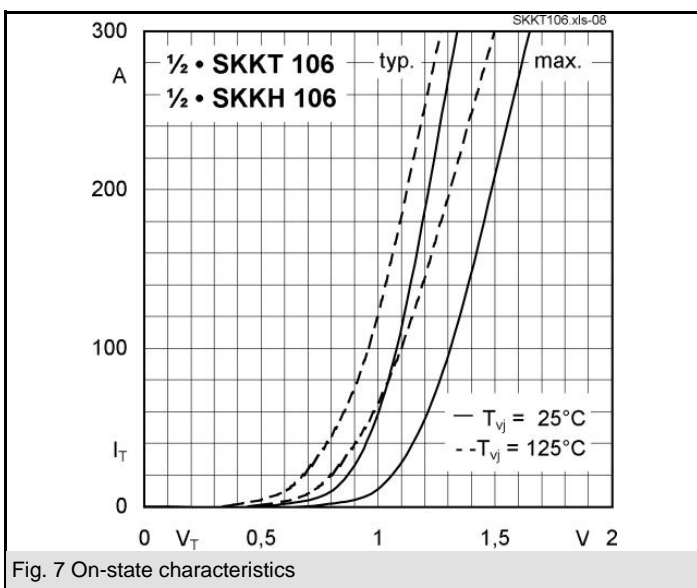
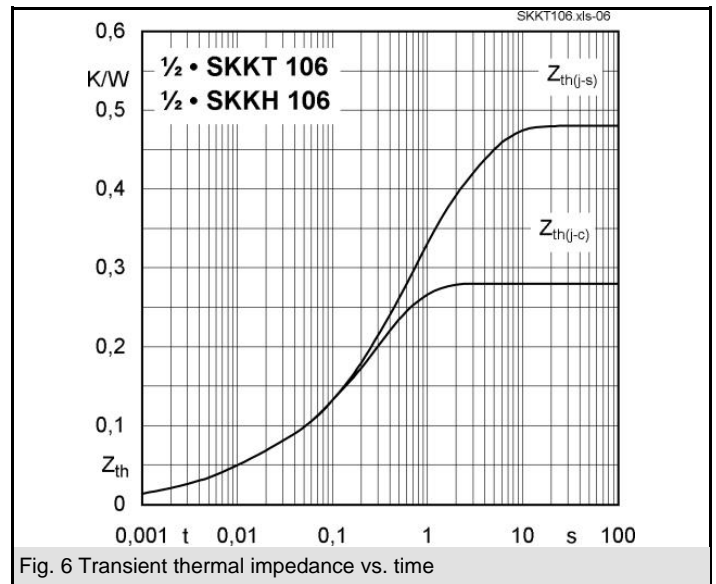
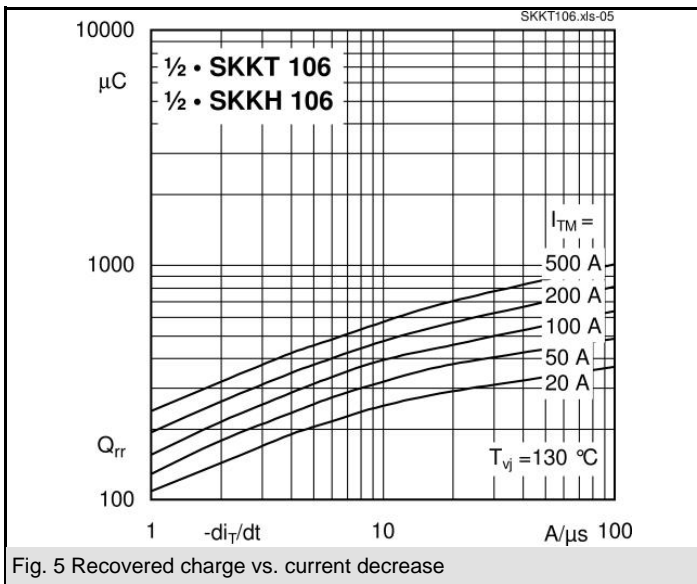
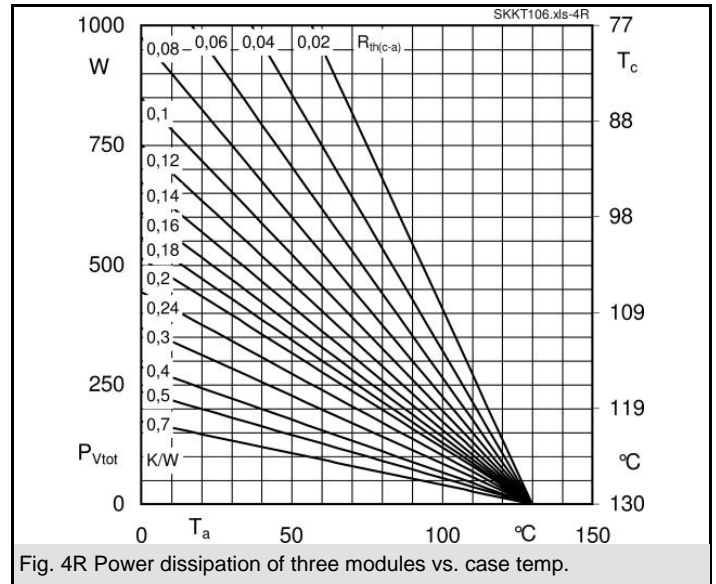
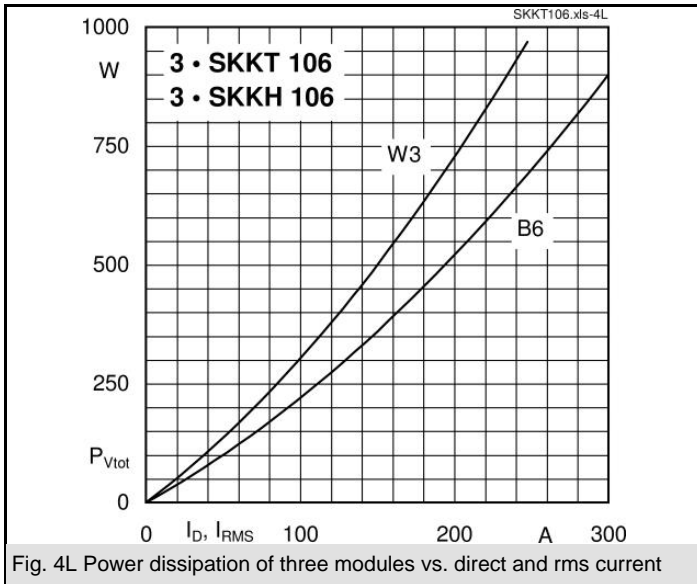

Fig. 3R Power dissipation of two modules vs. case temp.

# SKKT 106, SKKT 106B, SKKH 106



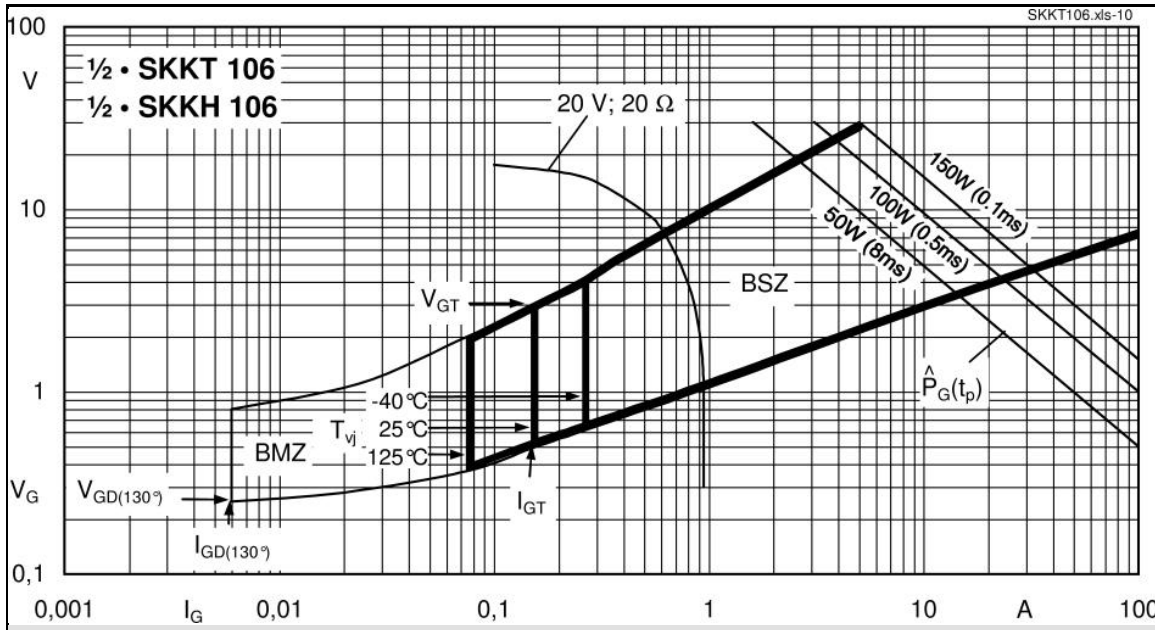
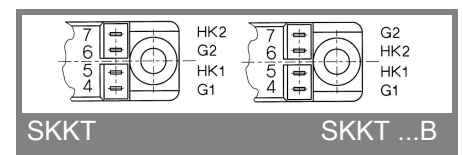
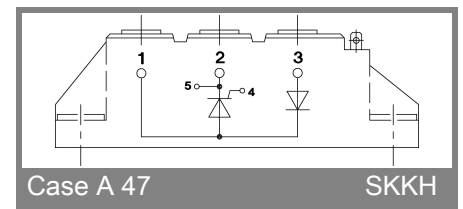
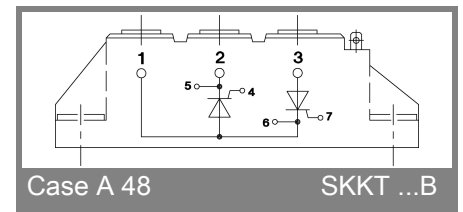
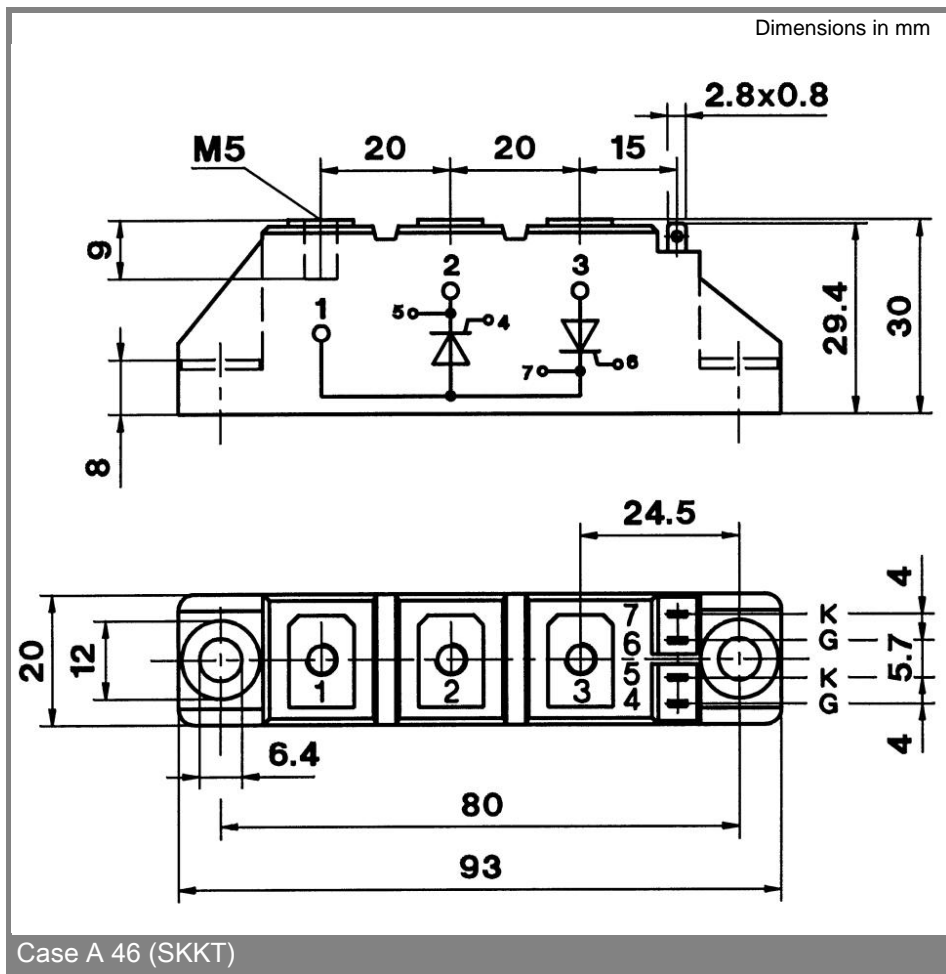

Fig. 9 Gate trigger characteristics



\* The specifications of our components may not be considered as an assurance of component characteristics. Components have to be tested for the respective application. Adjustments may be necessary. The use of SEMIKRON products in life support appliances and systems is subject to prior specification and written approval by SEMIKRON. We therefore strongly recommend prior consultation of our personal.