

NL Series — SMD Ferrite Wound Inductor



These revolutionary, highly reliable wound chip inductors for automatic mounting, have been developed in response to the trend toward high density in electronic equipment. With metal terminals and a body of heat resistant resin, these inductors offer many superior features.

Feature

- Very strong solderability by flow soldering, soldering iron or wave soldering.
- Highly accurate dimensions, can be mounted automatically.
- Terminals are highly resistant to pull forces.
- Highly resistant to mechanical shocks and pressure.
- Highly reliable in environments of sudden temperature change and humidity. Super Q characteristics.

Application

- Microtelevisions, liquid crystal televisions, video cameras, portable VCRs, car radios, car stereos, thin tape radios, television tuners, mobile telephones, radio and other electronic devices.

Dimensions

NL05SERIES—20x16x14

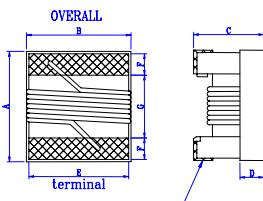

TERMINAL WRAPAROUND :
Approx. 0.015" / 0.38mm BOTH ENDS

Dimensions in mm

Unit	A	B	C	D	E	F	G
	Max.	Max.	Max.	Ref.			
mm	2.29	1.73	1.52	0.51	1.27	0.51	1.02

NL08 SERIES—25x20x18

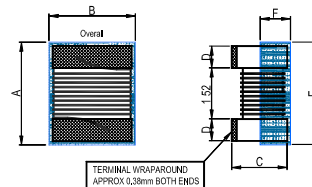

TERMINAL WRAPAROUND
APPROX 0.38mm BOTH ENDS

Dimensions in mm

Unit	A	B	C	D	E	F
	Max.	Max.	Max.	Ref.	Max.	Ref.
mm	2.92	2.79	2.1	0.51	2.92	0.51

How to Order

NL			08		J		T		--		1N6	
SEI Type			Dimensions		Inductance Tolerance		Packaging		Current		Inductance	
Type	Codes	Dimensions (LxWxH)	EIA	Code	Type	Code	Types	Type	Code	Type	Codes	Inductance
NL	05	2.0 x 1.6 x 1.4 mm	0805	J	5%	T	T	Tape and Reel	Blank	Normal	1N6	1.6nH
	08	2.5 x 2.0 x 1.8 mm	1008	K	10%				C	Large Current	82N	82nH
	10	3.2 x 2.5 x 2.2 mm	1210								R27	270nH
	12	4.5 x 3.2 x 3.2 mm	1812								2R7	2.7uH
	20	5.6 x 5.0 x 5.0 mm	2220								100	10uH
											101	100uH
											102	1,000uH

NL Series—SMD Ferrite Wound Inductor

Wound Chip Inductors (Ferrite) – NL05 Open Type

NL10 SERIES—32x25x22

NL20 SERIES—56x50x50

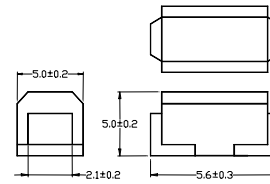
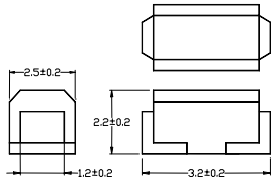

NL12 SERIES—45x32x32

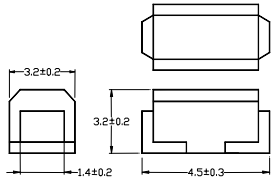

Standard Electrical Specifications

Part Number	Inductance (μH)	Tolerance (±%)	Q Min	Test Frequency (MHz)	Self Resonant Frequency (MHz)Min	DC Resistance (Ω)max	Rated current (mA)max
NL05JT-R12	0.12	5	20	25.2	500	0.20	600
NL05JT-R15	0.15	5	20	25.2	450	0.25	600
NL05JT-R18	0.18	5	20	25.2	410	0.30	570
NL05JT-R22	0.22	5	20	25.2	350	0.35	550
NL05JT-R27	0.27	5	20	25.2	280	0.40	530
NL05JT-R33	0.33	5	20	25.5	235	0.45	510
NL05JT-R39	0.39	5	20	25.2	210	0.50	490
NL05JT-R47	0.47	5	20	25.2	170	0.55	470
NL05JT-R56	0.56	5	20	25.2	150	0.60	450
NL05JT-R68	0.68	5	20	25.2	140	0.70	420
NL05JT-R82	0.82	5	20	25.2	130	0.75	400
NL05JT-1R0	1.0	5	15	7.96	80	1.2	400
NL05JT-1R2	1.2	5	15	7.96	95	0.90	325
NL05JT-1R5	1.5	5	15	7.96	75	1.45	350
NL05JT-1R8	1.8	5	15	7.96	80	1.20	270
NL05JT-2R2	2.2	5	15	7.96	70	1.8	300
NL05JT-2R7	2.7	5	15	7.96	70	1.60	230
NL05JT-3R3	3.3	5	15	7.96	68	2.3	250
NL05JT-3R9	3.9	5	15	7.96	55	2.0	190
NL05JT-4R7	4.7	5	15	7.96	55	2.8	200
NL05JT-5R6	5.6	5	15	7.96	40	2.7	150
NL05JT-6R8	6.8	5	15	7.96	40	3.4	180
NL05JT-8R2	8.2	5	15	7.96	33	3.6	120
NL05JT-100	10	5	10	2.52	38	4.7	150
NL05JT-120	12	5	15	2.52	25	4.50	105
NL05JT-150	15	5	10	2.52	30	6.5	140
NL05JT-180	18	5	15	2.52	25	5.5	90
NL05JT-220	22	5	10	2.52	25	8.0	120
NL05JT-270	27	5	15	2.52	18	6.5	75
NL05JT-330	33	5	10	2.52	20	10.7	100

NL Series—SMD Ferrite Wound Inductor

- ▶ When ordering , please specify tolerance and packaging code. Ex:NL05JT-1R0
 - Tolerance : J = 5%
 - Packaging : Clear tape and reel (standard)
- ▶ L , Q , RDC : HP4287A
- ▶ S R F : HP8753D / HP4291A
- ▶ Operating temperature range -25°C to +85°C

Test Instruments : *HP4291A Impedance / Material Analyzer*

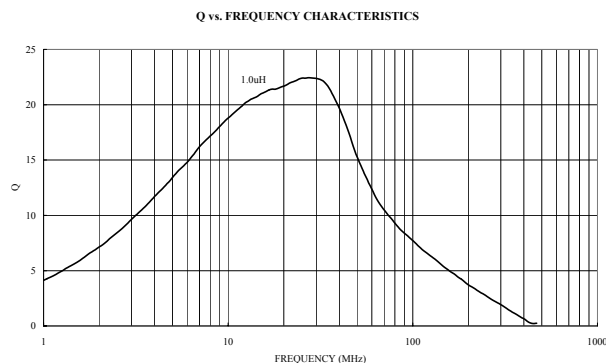
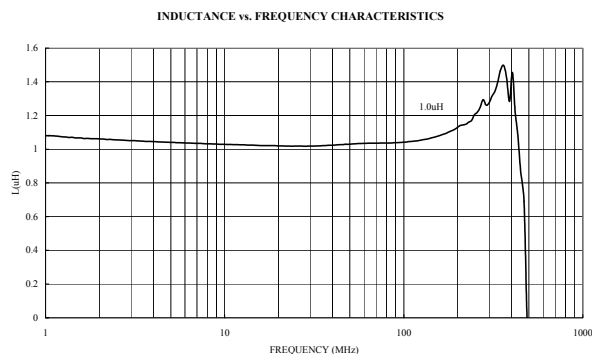

Wound Chip Inductors (Ferrite) – NL08 Large Current Series

Part Number	Inductance (μH)	Tolerance ($\pm\%$)	Q Min	Test Frequency (MHz)	Self Resonant Frequency (MHz)Min	DC Resistance (Ω)max	Rated current (mA)max
NL08JTC1R0	1.0	5	25	7.96	245	0.35	500
NL08JTC1R2	1.2	5	25	7.96	230	0.40	500
NL08JTC1R5	1.5	5	25	7.96	182	0.45	450
NL08JTC1R8	1.8	5	25	7.96	135	0.55	450
NL08JTC2R2	2.2	5	25	7.96	105	0.60	400
NL08JTC2R7	2.7	5	25	7.96	70	0.70	400
NL08JTC3R3	3.3	5	25	7.96	55	0.75	380
NL08JTC3R9	3.9	5	25	7.96	48	0.80	350
NL08JTC4R7	4.7	5	25	7.96	43	0.90	320
NL08JTC5R6	5.6	5	25	7.96	42	1.05	210
NL08JTC6R8	6.8	5	25	7.96	39	1.20	300
NL08JTC8R2	8.2	5	25	7.96	36	1.60	280
NL08JTC100	10	5	20	2.52	33	1.90	250
NL08JTC120	12	5	20	2.52	28	2.00	235
NL08JTC150	15	5	20	2.52	24	2.20	220
NL08JTC180	18	5	20	2.52	20	3.50	200
NL08JTC220	22	5	20	2.52	18	2.80	180
NL08JTC270	27	5	20	2.52	17	3.50	150
NL08JTC330	33	5	20	2.52	16	4.20	120

NL Series—SMD Ferrite Wound Inductor

Wound Chip Inductors (Ferrite) – NL08 Open Type

Standard Electrical Specifications

Part Number	Inductance (μ H)	Tolerance (\pm %)	Q Min	Test Frequency (MHz)	Self Resonant Frequency (MHz)Min	DC Resistance (Ω) max.	Rated current (mA) max.	COLOR CODING		
								1 ST	2 ND	3 RD
NL08□T-5N0	0.005	10	10	100	3,000	0.25	2,000	Black	Green	Black
NL08□T-10N	0.010	10	10	100	2,500	0.25	1,800	Brown	Black	Black
NL08□T-12N	0.012	10	15	100	2,400	0.26	1,700	Brown	Red	Black
NL08□T-15N	0.015	10	15	100	2,300	0.28	1,600	Brown	Green	Black
NL08□T-18N	0.018	10	15	100	2,200	0.30	1,550	Brown	Gray	Black
NL08□T-22N	0.022	10 / 5	20	100	2,100	0.35	1,500	Red	Red	Black
NL08□T-27N	0.027	10 / 5	20	100	2,000	0.40	1,450	Red	Violet	Black
NL08□T-33N	0.033	10 / 5	30	100	1,600	0.42	1,400	Orange	Orange	Black
NL08□T-39N	0.039	10 / 5	35	100	1,500	0.45	1,350	Orange	White	Black
NL08□T-47N	0.047	10 / 5	35	100	1,400	0.50	1,300	Yellow	Violet	Black
NL08□T-56N	0.056	10 / 5	35	100	1,300	0.60	1,250	Green	Blue	Black
NL08□T-68N	0.058	10 / 5	35	100	1,200	0.65	1,240	Blue	Gray	Black
NL08□T-82N	0.082	10 / 5	35	100	1,100	0.75	1,230	Gray	Red	Black
NL08□T-R10	0.10	10 / 5	35	100	800	0.80	1,220	Brown	Black	Brown
NL08□T-R12	0.12	10 / 5	30	25.2	700	0.30	900	Brown	Red	Brown
NL08□T-R15	0.15	10 / 5	30	25.2	550	0.35	900	Brown	Green	Brown
NL08□T-R18	0.18	10 / 5	30	25.2	500	0.40	850	Brown	Gray	Brown
NL08□T-R22	0.22	10 / 5	30	25.2	450	0.50	840	Red	Red	Brown
NL08□T-R27	0.27	10 / 5	30	25.2	425	0.55	830	Red	Violet	Brown
NL08□T-R33	0.33	10 / 5	30	25.2	400	0.60	820	Orange	Orange	Brown
NL08□T-R39	0.39	10 / 5	30	25.2	375	0.65	810	Orange	White	Brown
NL08□T-R47	0.47	10 / 5	30	25.2	350	0.68	800	Yellow	Violet	Brown
NL08□T-R56	0.56	10 / 5	30	25.2	325	0.75	800	Green	Blue	Brown
NL08□T-R68	0.68	10 / 5	30	25.2	300	0.85	800	Blue	Gray	Brown
NL08□T-R82	0.82	10 / 5	30	25.2	260	1.0	800	Gray	Red	Brown
NL08□T-1R0	1.0	10 / 5	25	7.96	245	1.1	800	Brown	Black	Red
NL08□T-1R2	1.2	10 / 5	25	7.96	230	1.2	790	Brown	Red	Red
NL08□T-1R5	1.5	10 / 5	25	7.96	182	1.3	750	Brown	Green	Red
NL08□T-1R8	1.8	10 / 5	25	7.96	135	1.45	750	Brown	Gray	Red
NL08□T-2R2	2.2	10 / 5	25	7.96	105	1.55	750	Red	Red	Red
NL08□T-2R7	2.7	10 / 5	25	7.96	70	1.7	740	Red	Violet	Red
NL08□T-3R3	3.3	10 / 5	25	7.96	55	1.9	730	Orange	Orange	Red
NL08□T-3R9	3.9	10 / 5	25	7.96	48	2.1	700	Orange	White	Red
NL08□T-4R7	4.7	10 / 5	25	7.96	43	2.3	650	Yellow	Violet	Red
NL08□T-5R6	5.6	10 / 5	20	7.96	42	2.5	640	Green	Blue	Red
NL08□T-6R8	6.8	10 / 5	20	7.96	39	2.7	630	Blue	Gray	Red
NL08□T-8R2	8.2	10 / 5	20	7.96	36	3.05	600	Gray	Red	Red
NL08□T-100	10	10 / 5	15	2.52	33	3.5	680	Brown	Black	Orange
NL08□T-120	12	10 / 5	15	2.52	30	3.8	650	Brown	Red	Orange
NL08□T-150	15	10 / 5	15	2.52	26	4.4	500	Brown	Green	Orange
NL08□T-180	18	10 / 5	15	2.52	24	4.8	450	Brown	Gray	Orange
NL08□T-220	22	10 / 5	15	2.52	22	5.5	450	Red	Red	Orange
NL08□T-270	27	10 / 5	15	2.52	21	6.3	430	Red	Violet	Orange
NL08□T-330	33	10 / 5	15	2.52	20	7.1	380	Orange	Orange	Orange
NL08□T-390	39	10 / 5	10	2.52	18	9.5	330	Orange	White	Orange
NL08□T-470	47	10 / 5	10	2.52	17	11.1	300	Yellow	Violet	Orange

NL Series — SMD Ferrite Wound Inductor

Wound Chip Inductors (Ferrite) – NL10 Molding Type

Standard Electrical Specifications

Part Number	Inductance (μH)	Tolerance ($\pm\%$)	Q Min	Test Frequency (MHz)	Self Resonant Frequency (MHz)Min	DC Resistance (Ω) max.	Rated current (mA) max.	COLOR CODING		
								1 ST	2 ND	3 RD
NL08□T-560	56	10 / 5	10	2.52	16	12.1	270	Green	Blue	Orange
NL08□T-680	68	10 / 5	10	2.52	15	16.6	250	Blue	Gray	Orange
NL08□T-820	82	10 / 5	10	2.52	13	19	200	Gray	Red	Orange
NL08□T-101	100	10 / 5	8	0.796	12	21	120	Brown	Black	Yellow

* UV COLOR: **BLUE** / CORE COLOR : **BLACK**

► When ordering , please specify tolerance and packaging code. Ex:NL08JT-101

Tolerance : J = 5% K =10%

Packaging : Clear tape and reel (standard) .

► L , Q , RDC : HP4287A

► S R F : HP8753D / HP4291A .

► Operating temperature range -25°C to $+85^{\circ}\text{C}$

Test Instruments : *HP4291A Impedance / Material Analyzer*

INDUCTANCE vs. FREQUENCY CHARACTERISTICS

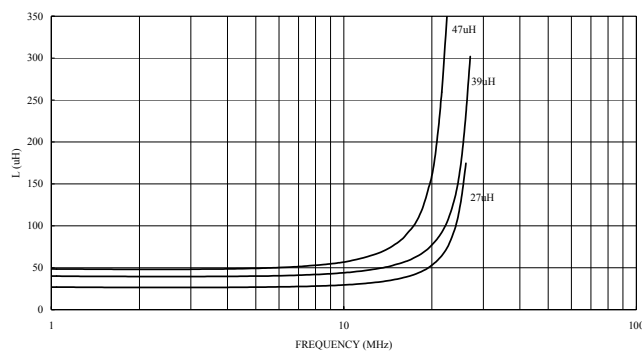

Q vs. FREQUENCY CHARACTERISTICS

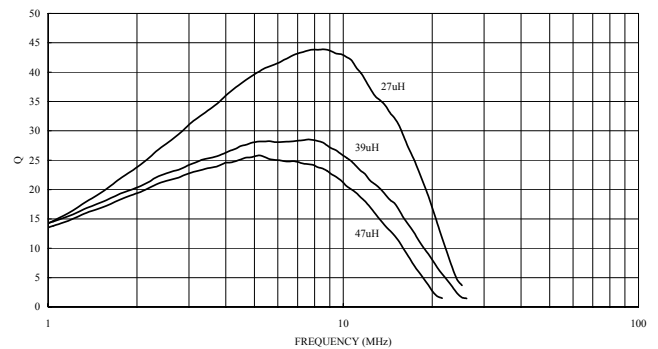

Standard Electrical Specifications

Part Number	Inductance (μH)	Tolerance ($\pm\%$)	Q Min.	Test Frequency (MHz)	Self Resonant Frequency (MHz)min.	DC Resistance (Ω)max.	Rated current (mA)
NL10KT-10N	0.010	10	15	100	2,500	0.13	450
NL10KT-12N	0.012	10	17	100	2,300	0.14	450
NL10KT-15N	0.015	10	19	100	2,100	0.16	450
NL10KT-18N	0.018	10	21	100	1,900	0.18	450
NL10KT-22N	0.022	10	23	100	1,700	0.20	450
NL10KT-27N	0.027	10	23	100	1,500	0.22	450
NL10KT-33N	0.033	10	25	100	1,400	0.24	450
NL10KT-39N	0.039	10	25	100	1,300	0.27	450
NL10KT-47N	0.047	10	26	100	1,200	0.30	450
NL10KT-56N	0.056	10	26	100	1,100	0.33	450
NL10KT-58N	0.058	10	27	100	1,000	0.36	450
NL10KT-82N	0.082	10	27	100	900	0.40	450
NL10KT-R10	0.10	10	28	100	700	0.44	450
NL10KT-R12	0.12	10	30	25.20	500	0.22	450
NL10KT-R15	0.15	10	30	25.20	450	0.25	450
NL10KT-R18	0.18	10	30	25.20	400	0.28	450
NL10KT-R22	0.22	10	30	25.20	350	0.32	450
NL10KT-R27	0.27	10	30	25.20	320	0.36	450

NL Series — SMD Ferrite Wound Inductor

Standard Electrical Specifications

Part Number	Inductance (μH)	Tolerance (± %)	Q Min.	Test Frequency (MHz)	Self Resonant Frequency (MHz)min.	DC Resistance (Ω)max.	Rated current (mA)
NL10KT-R33	0.33	10	30	25.20	300	0.40	450
NL10KT-R39	0.39	10	30	25.20	250	0.45	450
NL10KT-R47	0.47	10	30	25.20	220	0.50	450
NL10KT-R56	0.56	10	30	25.20	180	0.55	450
NL10KT-R68	0.68	10	30	25.20	160	0.60	450
NL10KT-R82	0.82	10	30	25.20	140	0.65	450
NL10KT-1R0	1.00	10	30	7.960	120	0.70	400
NL10KT-1R2	1.20	10	30	7.960	100	0.75	390
NL10KT-1R5	1.50	10	30	7.960	85	0.85	370
NL10KT-1R8	1.80	10	30	7.960	80	0.90	350
NL10KT-2R2	2.20	10	30	7.960	75	1.00	320
NL10KT-2R7	2.70	10	30	7.960	70	1.10	290
NL10KT-3R3	3.30	10	30	7.960	60	1.20	260
NL10KT-3R9	3.90	10	30	7.960	55	1.30	250
NL10KT-4R7	4.70	10	30	7.960	50	1.50	220
NL10KT-5R6	5.60	10	30	7.960	45	1.60	200
NL10KT-6R8	6.80	10	30	7.960	40	1.80	180
NL10KT-8R2	8.20	10	30	7.960	35	2.00	170
NL10KT-100	10	10	30	2.520	30	2.10	150
NL10KT-120	12	10	30	2.520	20	2.50	140
NL10KT-150	15	10	30	2.520	20	2.80	130
NL10KT-180	18	10	30	2.520	20	3.30	120
NL10KT-220	22	10	30	2.520	20	3.70	110
NL10KT-270	27	10	30	2.520	20	5.00	80
NL10KT-330	33	10	30	2.520	17	5.60	70
NL10KT-390	39	10	30	2.520	16	6.40	65
NL10KT-470	47	10	30	2.520	15	7.00	60
NL10KT-560	56	10	30	2.520	13	8.00	55
NL10KT-680	68	10	30	2.520	12	9.00	50
NL10KT-820	82	10	30	2.520	11	10.0	45
NL10KT-101	100	10	20	0.796	10	10.0	40
NL10KT-121	120	10	20	0.796	10	11.0	70
NL10KT-151	150	10	20	0.796	8	15.0	65
NL10KT-181	180	10	20	0.796	7	17.0	60
NL10KT-221	220	10	20	0.796	7	21.0	50
NL10KT-271	270	10	20	0.796	6	28.0	45
NL10KT-331	330	10	20	0.796	5	34.0	40

Test Instruments: HP 4286A RF Impedance Analyzer for L、Q、SRF Digital Multimeter SC-7401 for RDC
 HP4285A LF Impedance Analyzer for L、Q CHEN-HWA 1051+CHEN-WHA 301A for IDC

Test Instruments : *HP4291A Impedance / Material Analyzer*

INDUCTANCE vs. FREQUENCY CHARACTERISTICS

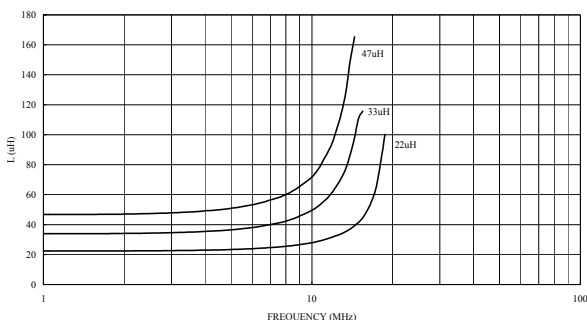

Q vs. FREQUENCY CHARACTERISTICS

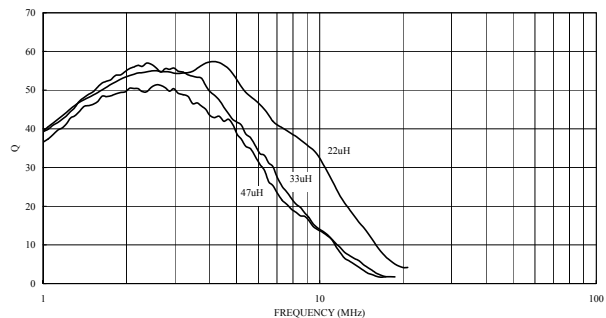

NL Series — SMD Ferrite Wound Inductor

Wound Chip Inductors (Ferrite) – NL12 Molding Type

Standard Electrical Specifications

Part Number	Inductance (μ H)	Tolerance (\pm %)	Q Min.	Test Frequency (MHz)	Self Resonant Frequency (MHz)min.	DC Resistance (Ω)max.	Rated current (mA)
NL12MT-R10	0.10	20	28	25.20	700	0.44	450
NL12MT-R12	0.12	20	30	25.20	500	0.22	450
NL12MT-R15	0.15	20	30	25.20	450	0.25	450
NL12MT-R18	0.18	20	30	25.20	400	0.28	450
NL12MT-R22	0.22	20	30	25.20	350	0.32	450
NL12MT-R27	0.27	20	30	25.20	320	0.36	450
NL12MT-R33	0.33	20	30	25.20	300	0.40	450
NL12MT-R39	0.39	20	30	25.20	250	0.45	450
NL12MT-R47	0.47	20	30	25.20	220	0.50	450
NL12MT-R56	0.56	20	30	25.20	180	0.55	450
NL12MT-R68	0.68	20	30	25.20	160	0.60	450
NL12MT-R82	0.82	20	30	25.20	140	0.67	450
NL12KT-1R0	1.00	10	50	7.960	100	0.50	450
NL12KT-1R2	1.20	10	50	7.960	80	0.55	430
NL12KT-1R5	1.50	10	50	7.960	70	0.60	410
NL12KT-1R8	1.80	10	50	7.960	60	0.65	390
NL12KT-2R2	2.20	10	50	7.960	55	0.70	380
NL12KT-2R7	2.70	10	50	7.960	50	0.75	370
NL12KT-3R3	3.30	10	50	7.960	45	0.80	355
NL12KT-3R9	3.90	10	50	7.960	40	0.90	330
NL12KT-4R7	4.70	10	50	7.960	35	1.00	315
NL12KT-5R6	5.60	10	50	7.960	33	1.10	300
NL12KT-6R8	6.80	10	50	7.960	27	1.20	285
NL12KT-8R2	8.20	10	50	7.960	25	1.40	270
NL12KT-100	10	10	50	2.520	20	1.60	250
NL12KT-120	12	10	50	2.520	18	2.00	225
NL12KT-150	15	10	50	2.520	17	2.50	200
NL12KT-180	18	10	50	2.520	15	2.80	190
NL12KT-220	22	10	50	2.520	13	3.20	180
NL12KT-270	27	10	50	2.520	12	3.60	170
NL12KT-330	33	10	50	2.520	11	4.00	160
NL12KT-390	39	10	50	2.520	10	4.50	150
NL12KT-470	47	10	50	2.520	10	5.00	140
NL12KT-560	56	10	50	2.520	9	5.50	135
NL12KT-680	68	10	50	2.520	9	6.00	130
NL12KT-820	82	10	50	2.520	8	7.00	120
NL12KT-101	100	10	40	0.796	8	8.00	110
NL12KT-121	120	10	40	0.796	6	8.00	110
NL12KT-151	150	10	40	0.796	5	9.00	105
NL12KT-181	180	10	40	0.796	5	9.50	102
NL12KT-221	220	10	40	0.796	4	12.00	100
NL12KT-271	270	10	30	0.796	4	18.00	92
NL12KT-331	330	10	30	0.796	3.5	20.00	85
NL12KT-391	390	10	30	0.796	3	23.00	80
NL12KT-471	470	10	30	0.796	3	26.00	62
NL12KT-561	560	10	30	0.796	3	30.00	50

NL Series — SMD Ferrite Wound Inductor

Wound Chip Inductors (Ferrite) – NL20 Molding Type

Standard Electrical Specifications

Part Number	Inductance (μH)	Tolerance (± %)	Q Min.	Test Frequency (MHz)	Self Resonant Frequency (MHz)min.	DC Resistance (Ω)max.	Rated current (mA)
NL12KT-681	680	10	30	0.796	3	40.00	50
NL12KT-821	820	10	30	0.796	2.5	45.00	30
NL12KT-102	1,000	10	30	0.796	2.5	50.00	30

Test Instruments : HP4291A Impedance / Material Analyzer

INDUCTANCE vs. FREQUENCY CHARACTERISTICS

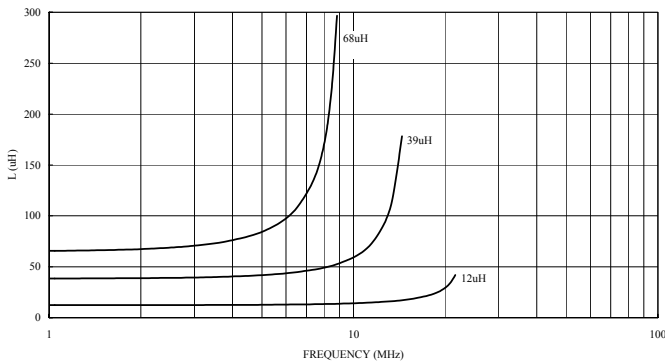

Q vs. FREQUENCY CHARACTERISTICS

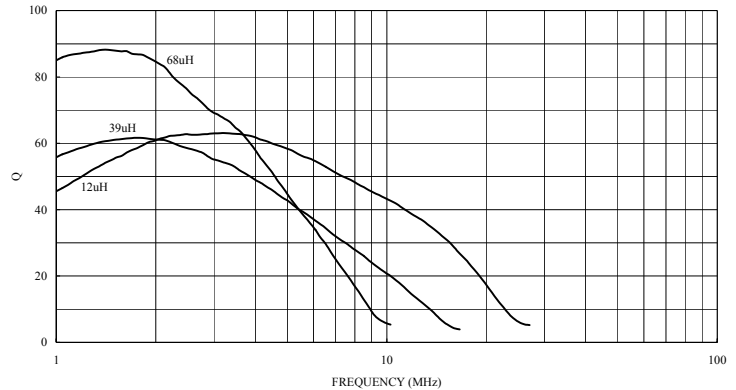

Standard Electrical Specifications

Part Number	Inductance (mH)	Tolerance (± %)	Q Min.	Test Frequency (MHz)	Self Resonant Frequency (MHz)min.	DC Resistance (Ω)max.	Rated current (mA)
NL20□T-125	1.2	5 / 10	30	0.252	1.5	17	75
NL20□T-155	1.5	5 / 10	30	0.252	1.4	20	70
NL20□T-185	1.8	5 / 10	30	0.252	1.3	30	60
NL20□T-225	2.2	5 / 10	30	0.252	1.2	35	55
NL20□T-275	2.7	5 / 10	30	0.252	1.1	55	45
NL20□T-335	3.3	5 / 10	30	0.252	1	60	40
NL20□T-395	3.9	5 / 10	30	0.252	1	70	38
NL20□T-475	4.7	5 / 10	30	0.252	0.9	78	36
NL20□T-565	5.6	5 / 10	30	0.252	0.8	85	33
NL20□T-685	6.8	5 / 10	30	0.252	0.7	110	30
NL20□T-825	8.2	5 / 10	30	0.252	0.6	125	28
NL20□T-106	10	5 / 10	20	0.0796	0.5	150	25

Test Instruments: HP 4286A RF Impedance Analyzer for L、Q、SRF Digital Multimeter SC-7401 for RDC
 HP4285A LF Impedance Analyzer for L、Q CHEN-HWA 1051+CHEN-WHA 301A for IDC

NL Series — SMD Ferrite Wound Inductor

Wound Chip Inductors (Ferrite) – NL Series

Test Instruments : *HP4291A Impedance / Material Analyzer*

INDUCTANCE vs. FREQUENCY CHARACTERISTICS

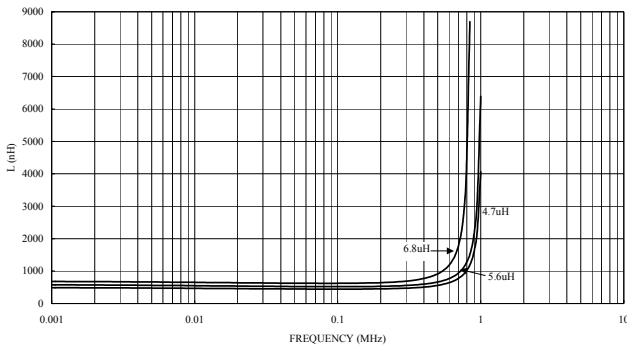

Q vs. FREQUENCY CHARACTERISTICS

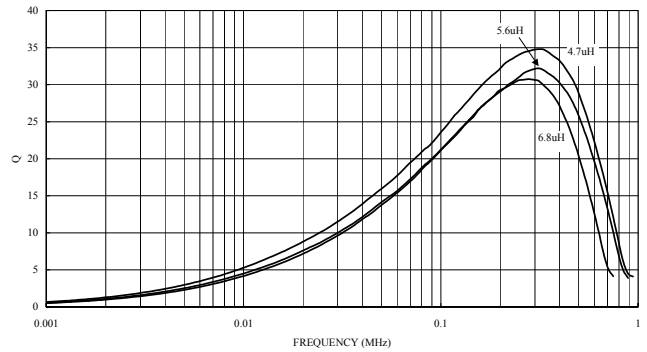

Recommended Pattern :

NL05 SERIES-20×16×14

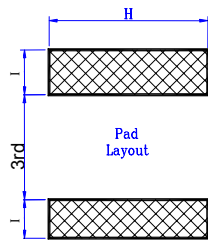

Dimensions in mm

Unit	H	I	J
mm	1.78	1.02	0.76

NL08 SERIES-25×20×18

DIMENSIONS in mm
PAD LAYOUT

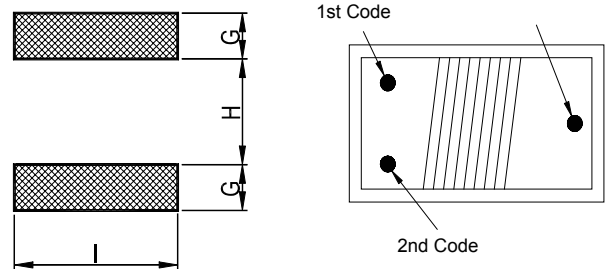

Dimensions in mm

Unit	G	H	I
mm	1.02	1.27	2.54

NL10 SERIES-32×25×22

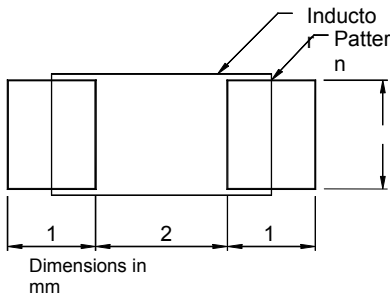

NL12 SERIES-45×32×32

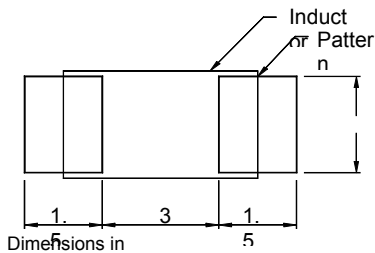

NL20 SERIES-56×50×50

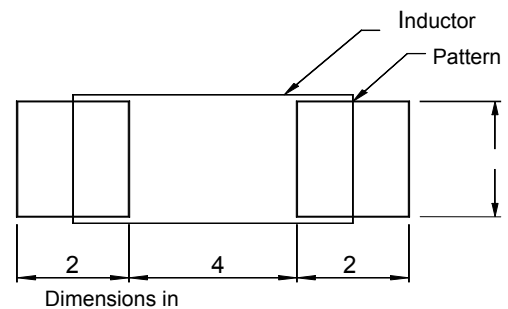

NL Series — SMD Ferrite Wound Inductor

Packaging

Tape Dimensions

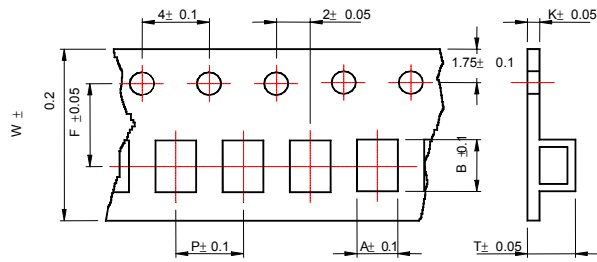

Reel Dimensions

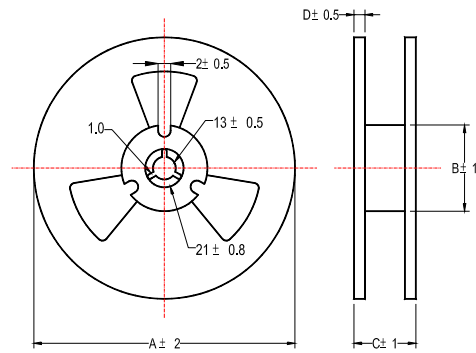

Figure 1

Tape Material

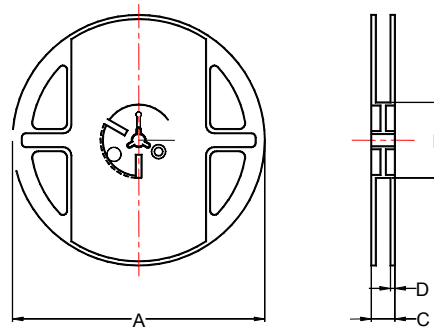
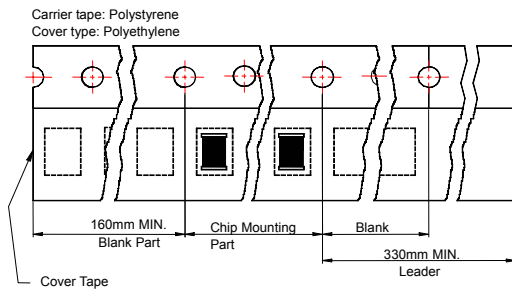

Figure 2

Dimensions in mm

TYPE	Tape Dimensions							Reel Dimensions				Quantity /Reel	
	A	B	T	W	P	F	K	Fig	A	B	C		D
NL05(201614)	1.88	2.38	1.48	8	4	3.5	0.2	2	178	60	13	9	2,500
NL08(252018)	2.61	2.83	2.25	8	4	3.5	0.25	2	178	60	12	1.5	2,000
NL10(322522)	2.94	3.64	2.52	8	4	3.5	0.2	1	178	60	10	1.5	2,000
NL12(453232)	3.64	5.14	3.6	12	8	5.5	0.3	1	250	80	14	1.5	500
NL20(565050)	4.9	5.65	5.3	16.15	12.2	5.5	0.5	2	330	80	20	2	1,000

NL Series — SMD Ferrite Wound Inductor

Wound Chip Inductors (Ferrite) – NL Series

1-1 Mechanical Performance

No		Specification	Test Method
1-1-1	Vibration	Appearance: No damage L change: within±10% Q change: within±30%	Test device shall be soldered on the substrate Oscillation Frequency: 10 to 55 to 10Hz for 1min Amplitude: 1.5mm Time: 2hrs for each axis (X, Y & Z), total 6hrs
1-1-2	Resistance to Soldering Heat	Appearance: No damage	Pre-heating: 150°C, 1min Solder Composition: Sn/Pb = 63/37 Solder Temperature: 260±5°C Immersion Time: 10±1sec
1-1-3	Solderability	The electrodes shall be at least 90% covered with new solder coating	Pre-heating: 150°C, 1min Solder Composition: Sn/Pb = 63/37 Solder Temperature: 230±5°C Immersion Time: 4±1sec

1-2 Environmental Performance

No	Item	Specification	Test Method															
1-2-1	Temperature Cycle	Appearance: No damage L change: within±10% Q change: within±30%	One cycle: <table border="1"> <thead> <tr> <th>Step</th> <th>Temperature (°C)</th> <th>Time (min)</th> </tr> </thead> <tbody> <tr> <td>1</td> <td>-25±3</td> <td>30</td> </tr> <tr> <td>2</td> <td>25±2</td> <td>3</td> </tr> <tr> <td>3</td> <td>85±3</td> <td>30</td> </tr> <tr> <td>4</td> <td>25±2</td> <td>3</td> </tr> </tbody> </table> Total: 100cycles Measured after exposure in the room condition for 24hrs	Step	Temperature (°C)	Time (min)	1	-25±3	30	2	25±2	3	3	85±3	30	4	25±2	3
Step	Temperature (°C)	Time (min)																
1	-25±3	30																
2	25±2	3																
3	85±3	30																
4	25±2	3																
1-2-2	Humidity Resistance		Temperature: 40±2°C Relative Humidity: 90 ~ 95% Time: 1,000hrs Measured after exposure in the room condition for 24hrs															
1-2-3	High Temperature Resistance		Temperature: 85±3°C Relative Humidity: 20% Applied Current: Rated Current Time: 1,000hrs Measured after exposure in the room condition for 24hrs															
1-2-4	Low Temperature Resistance		Temperature: -25±3°C Relative Humidity: 0% Time: 1,000hrs Measured after exposure in the room condition for 24hrs															

NL Series—SMD Ferrite Wound Inductor

Wound Chip Inductors (Ferrite) – NL Large Current Series

Dimensions

NL08□TC SERIES—25x20x18

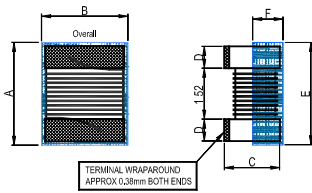

Dimensions in mm

Unit	A	B	C	D	E	F
mm	2.92 ⁺⁰	2.79 ⁺⁰	2.1 ⁺⁰	0.51	2.92 ⁺⁰	0.51ref

NL10□TC SERIES—32x25x22

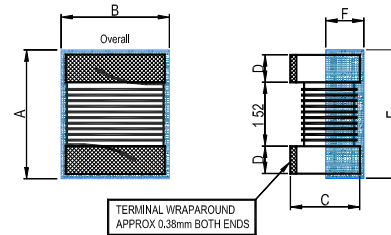

Dimensions in mm

Unit	A	B	C	D	E	F
mm	3.70 ⁺⁰	2.90 ⁺⁰	2.60 ⁺⁰	0.51	3.7	0.51ref

NL12 SERIES—45x32x32

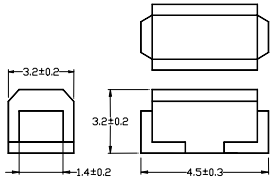

NL20 SERIES—56x50x50

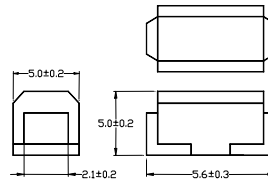

Standard Electrical Specifications

Part Number	Inductance (μH)	Tolerance (±%)	Q Min	Test Frequency (MHz)	Self Resonant Frequency (MHz)min	DC Resistance (Ω)max	Rated current (mA)	COLOR CODING		
NL08□TC1R0	1.0	20	15	7.96	200	0.34	700	Brown	Black	Red
NL08□TC1R5	1.5	20	15	7.96	165	0.42	650	Brown	Green	Red
NL08□TC2R2	2.2	20	15	7.96	95	0.50	630	Red	Red	Red
NL08□TC3R3	3.3	20	15	7.96	55	0.65	600	Orange	Orange	Red
NL08□TC4R7	4.7	20	15	7.96	43	0.80	580	Yellow	Violet	Red
NL08□TC6R8	6.8	20	15	7.96	39	1.00	550	Blue	Gray	Red
NL08□TC100	10	10	15	2.52	32	1.69	500	Brown	Black	Orange
NL08□TC150	15	10	15	2.52	21	2.20	450	Brown	Green	Orange
NL08□TC220	22	10	13	2.52	18	2.80	350	Red	Red	Orange
NL08□TC330	33	10	13	2.52	16	4.20	300	Orange	Orange	Orange

- ▶ When ordering , please specify tolerance and packaging code. Ex:NL08JTC6R8
 Tolerance : J = 5% : K= 10%
 Packaging : Clear tape and reel (standard) .
- ▶ L , Q : HP4287A
- ▶ S R F : HP8753D / HP4291A .
- ▶ RDC : Digital Multimeter SC - 7401
- ▶ Operating temperature range -25°C to + 85°C

Wound Chip Inductors (Ferrite) – NL Large Current Series

Standard Electrical Specifications

Part Number	Inductance (μH)	Tolerance (±%)	Q Min	Test Frequency (MHz)	Self Resonant Frequency (MHz)min	DC Resistance ±30% (Ω)	Rated current (mA)min	COLOR CODING		
NL10□TC1R0	1.0	5 / 10	20	7.96	100	0.08	1,500	Brown	Black	Red
NL10□TC1R5	1.5	5 / 10	20	7.96	80	0.13	1,125	Brown	Green	Red
NL10□TC2R2	2.2	5 / 10	20	7.96	68	0.13	970	Red	Red	Red
NL10□TC3R3	3.3	5 / 10	20	7.96	54	0.16	837	Orange	Orange	Red
NL10□TC4R7	4.7	5 / 10	20	7.96	43	0.20	675	Yellow	Violet	Red
NL10□TC6R8	6.8	5 / 10	20	7.96	33	0.27	600	Blue	Gray	Red
NL10□TC100	10	5 / 10	15	2.52	28	0.36	520	Brown	Black	Orange
NL10□TC150	15	5 / 10	15	2.52	19	0.56	480	Brown	Green	Orange
NL10□TC220	22	5 / 10	15	2.52	16	0.77	310	Red	Red	Orange
NL10□TC330	33	5 / 10	15	2.52	12	1.10	270	Orange	Orange	Orange
NL10□TC470	47	5 / 10	15	2.52	10	1.64	210	Yellow	Violet	Orange
NL10□TC680	68	5 / 10	15	2.52	9	2.80	189	Blue	Gray	Orange
NL10□TC101	100	5 / 10	15	0.796	6	3.70	145	Brown	Black	Yellow
NL10□TC151	150	5 / 10	15	0.796	5	6.10	120	Brown	Green	Yellow
NL10□TC221	220	5 / 10	15	0.796	4	8.40	100	Red	Red	Yellow
NL10□TC331	330	5 / 10	15	0.796	3.5	12.3	80	Orange	Orange	Yellow
NL10□TC471	470	5 / 10	15	0.796	2.8	22.0	75	Yellow	Violet	Yellow
NL10□TC681	680	5 / 10	15	0.796	2	28.0	65	Blue	Gray	Yellow

- ▶ When ordering , please specify tolerance and packaging code. Ex:NL10JTC101
 Tolerance : J = 5% K= 10%
 Packaging : Clear tape and reel (standard) .
- ▶ L , Q : HP4287A
- ▶ S R F : HP8753D / HP4291A .
- ▶ RDC : Digital Multimeter SC - 7401
- ▶ Operating temperature range -25°C to + 85°C

Test Instruments : *HP4291A Impedance / Material Analyzer*

INDUCTANCE vs. FREQUENCY CHARACTERISTICS

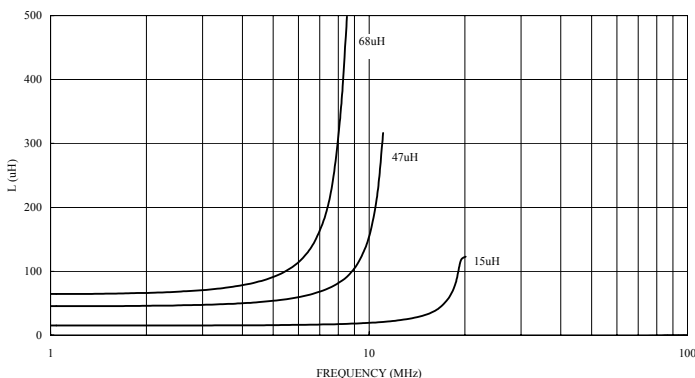

Q vs. FREQUENCY CHARACTERISTICS

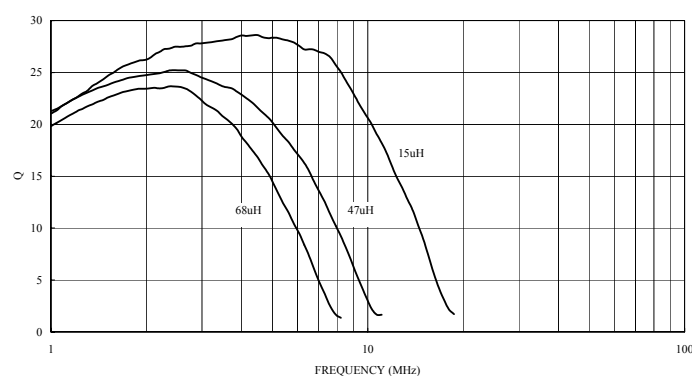

NL Series — SMD Ferrite Wound Inductor

Wound Chip Inductors (Ferrite) – NL Large Current Series

Standard Electrical Specifications

Part Number	Inductance (μH)	Tolerance (± %)	Q Min.	Test Frequency (MHz)	Self Resonant Frequency (MHz)min.	DC Resistance (Ω)max.	Rated current (mA)
NL12KTC1R0	1.0	10	10	7.96	200	0.11	1,050
NL12KTC1R2	1.2	10	10	7.96	160	0.12	1,000
NL12KTC1R5	1.5	10	10	7.96	130	0.15	950
NL12KTC1R8	1.8	10	10	7.96	100	0.16	900
NL12KTC2R2	2.2	10	10	7.96	60	0.18	850
NL12KTC2R7	2.7	10	10	7.96	60	0.20	800
NL12KTC3R3	3.3	10	10	7.96	45	0.22	750
NL12KTC3R9	3.9	10	10	7.96	40	0.24	700
NL12KTC4R7	4.7	10	10	7.96	35	0.27	650
NL12KTC5R6	5.6	10	10	7.96	30	0.30	650
NL12KTC6R8	6.8	10	10	7.96	28	0.35	600
NL12KTC8R2	8.2	10	10	7.96	25	0.40	600
NL12KTC100	10	10	10	2.52	22	0.50	550
NL12KTC120	12	10	10	2.52	21	0.60	500
NL12KTC150	15	10	10	2.52	20	0.70	450
NL12KTC180	18	10	10	2.52	19	0.80	400
NL12KTC220	22	10	10	2.52	18	0.90	370
NL12KTC270	27	10	10	2.52	16	1.20	330
NL12KTC330	33	10	10	2.52	14	1.40	300
NL12KTC390	39	10	10	2.52	12	1.60	280
NL12KTC470	47	10	10	2.52	11.5	1.90	260
NL12KTC560	56	10	10	2.52	11	2.20	240
NL12KTC680	68	10	10	2.52	10	2.60	220
NL12KTC820	82	10	10	2.52	9	3.50	200
NL12KTC101	100	10	20	0.796	8	4.00	180
NL12KTC121	120	10	20	0.796	6.5	4.50	160
NL12KTC151	150	10	20	0.796	7	6.50	140
NL12KTC181	180	10	20	0.796	5.5	7.50	120
NL12KTC221	220	10	20	0.796	5.5	9.00	120
NL12KTC271	270	10	20	0.796	5	11.0	100
NL12KTC331	330	10	20	0.796	4	13.0	90

Test Instruments: HP4286A RF Impedance Analyzer for L、Q、SRF Digital Multimeter SC-7401 for RDC
 HP4285A LF Impedance Analyzer for L、Q CHEN-HWA 1051+CHEN-WHA 301A for IDC

Test Instruments : *HP4291A Impedance / Material Analyzer*

INDUCTANCE vs. FREQUENCY CHARACTERISTICS

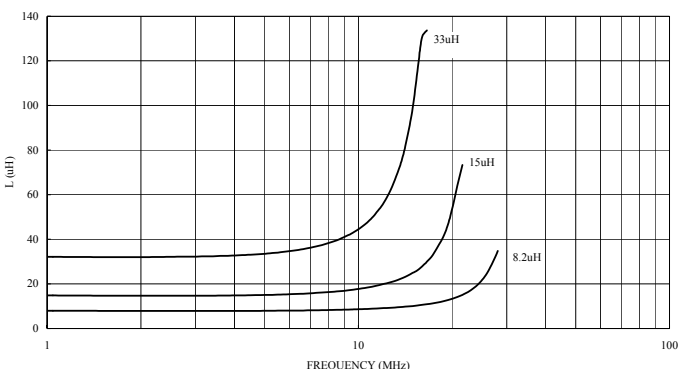

Q vs. FREQUENCY CHARACTERISTICS

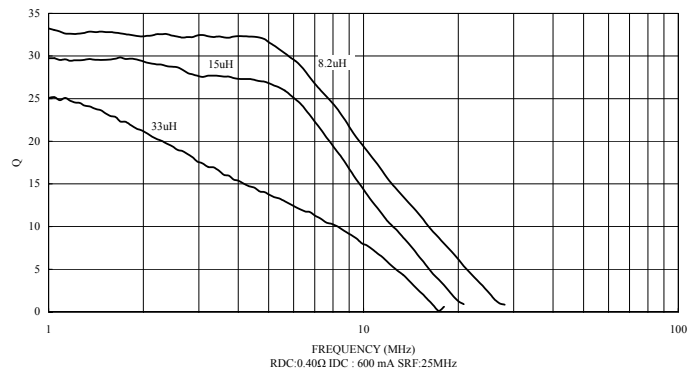

NL Series — SMD Ferrite Wound Inductor

Wound Chip Inductors (Ferrite) – NL Large Current Series

Standard Electrical Specifications

Part Number	Inductance (μ H)	Tolerance (\pm %)	Q Min.	Test Frequency (MHz)	Self Resonant Frequency (MHz)min.	DC Resistance (Ω)max.	Rated current (mA)
NL20KTC1R0	1.0	10	10	7.96	95	0.03	1,800
NL20KTC1R2	1.2	10	10	7.96	70	0.035	1,700
NL20KTC1R5	1.5	10	10	7.96	55	0.04	1,600
NL20KTC1R8	1.8	10	10	7.96	47	0.05	1,400
NL20KTC2R2	2.2	10	10	7.96	42	0.05	1,300
NL20KTC2R7	2.7	10	10	7.96	37	0.07	1,200
NL20KTC3R3	3.3	10	10	7.96	34	0.08	1,120
NL20KTC3R9	3.9	10	10	7.96	32	0.09	1,050
NL20KTC4R7	4.7	10	10	7.96	29	0.11	950
NL20KTC5R6	5.6	10	10	7.96	26	0.13	880
NL20KTC6R8	6.8	10	10	7.96	24	0.15	810
NL20KTC8R2	8.2	10	10	7.96	22	0.18	750
NL20KTC100	10	10	10	2.52	19	0.21	690
NL20KTC120	12	10	10	2.52	17	0.25	630
NL20KTC150	15	10	10	2.52	16	0.30	580
NL20KTC180	18	10	10	2.52	14	0.36	530
NL20KTC220	22	10	10	2.52	13	0.43	480
NL20KTC270	27	10	10	2.52	11.5	0.52	440
NL20KTC330	33	10	10	2.52	10.5	0.62	400
NL20KTC390	39	10	10	2.52	9.5	0.72	370
NL20KTC470	47	10	10	2.52	8.5	0.85	340
NL20KTC560	56	10	10	2.52	7.8	1.00	310
NL20KTC680	68	10	10	2.52	7	1.2	290
NL20KTC820	82	10	10	2.52	6.4	1.4	270
NL20KTC101	100	10	20	0.796	6	1.6	250
NL20KTC121	120	10	20	0.796	5.4	1.9	230
NL20KTC151	150	10	20	0.796	4.8	2.2	210
NL20KTC181	180	10	20	0.796	4.4	2.8	190
NL20KTC221	220	10	20	0.796	3.9	3.4	170
NL20KTC271	270	10	20	0.796	3.6	4.2	155
NL20KTC331	330	10	20	0.796	3.2	4.9	140
NL20KTC391	390	10	20	0.796	2.9	5.8	130
NL20KTC471	470	10	20	0.796	2.6	7	120
NL20KTC561	560	10	20	0.796	2.4	8.5	110
NL20KTC681	680	10	20	0.796	2.2	10	100
NL20KTC821	820	10	20	0.796	2	13	90
NL20KTC102	1,000	10	20	0.252	1.8	15	85

Test Instruments: HP 4286A RF Impedance Analyzer for L、Q、SRF Digital Multimeter SC-7401 for RDC
 HP4285A LF Impedance Analyzer for L、Q CHEN-HWA 1051+CHEN-WHA 301A for IDC

NL Series — SMD Ferrite Wound Inductor

Wound Chip Inductors (Ferrite) – NL Large Current Series

Test Instruments : *HP4291A Impedance / Material Analyzer*

INDUCTANCE vs. FREQUENCY CHARACTERISTICS

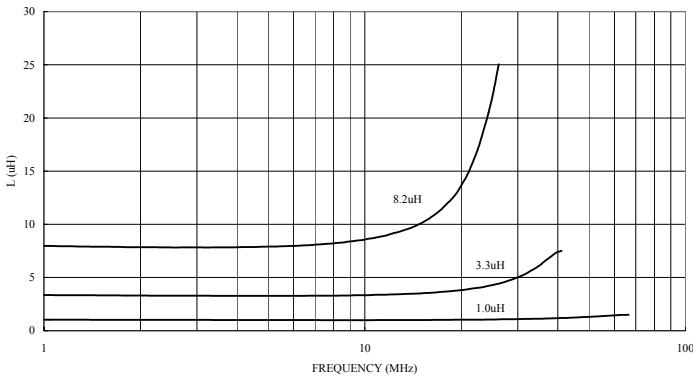

Q vs. FREQUENCY CHARACTERISTICS

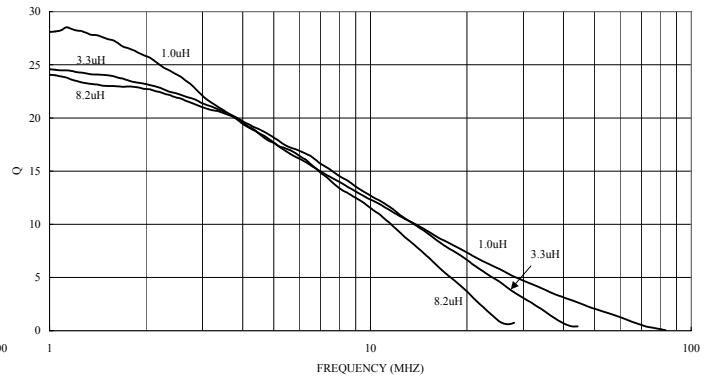

Recommended Pattern :

NL08□TC SERIES—25×20×18

DIMENSIONS in mm
PAD LAYOUT

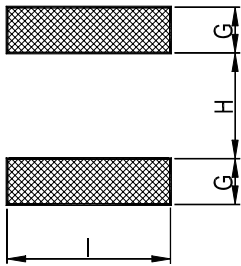

Dimensions in mm

Unit	G	H	I
mm	1.02	1.27	2.54

NL10□TC SERIES—32×25×22

DIMENSIONS in mm
PAD LAYOUT

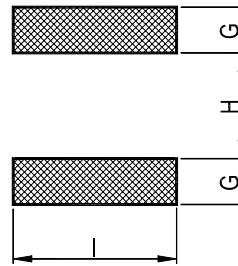

Dimensions in mm

Unit	G	H	I
mm	1.00	2.00	2.70

NL12□TC SERIES—45×32×32

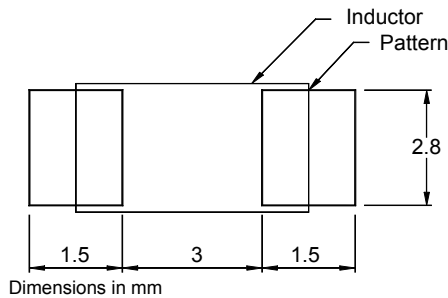

NL20□TC SERIES—56×50×50

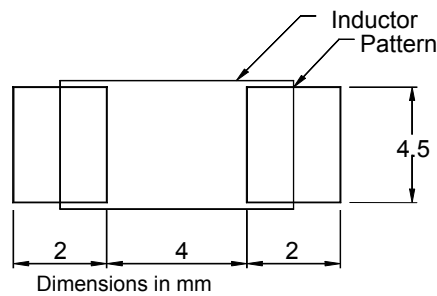

NL Series—SMD Ferrite Wound Inductor

Wound Chip Inductors (Ferrite) – NL Large Current Series

Packaging

Tape Dimensions

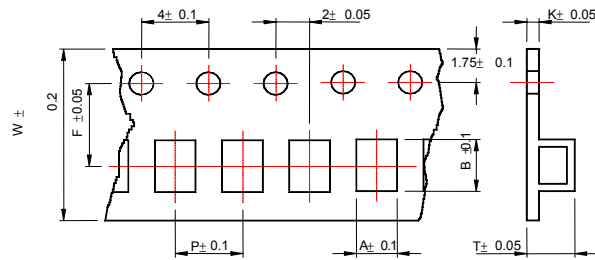

Reel Dimensions

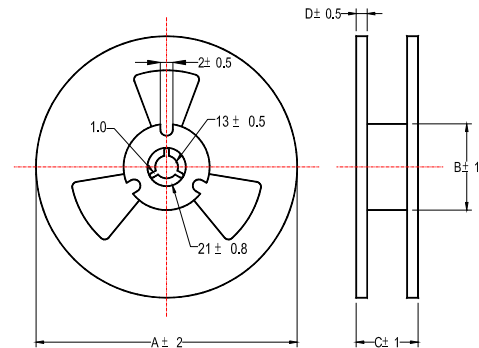

Figure 1

Tape Material

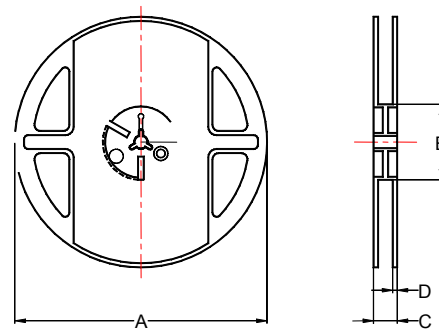
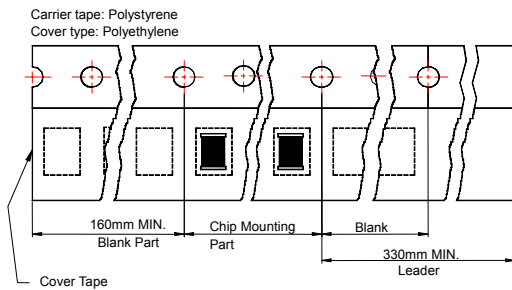

Figure 2

Dimensions in mm

TYPE	Tape Dimensions							Reel Dimensions				Quantity /Reel	
	A	B	T	W	P	F	K	Fig	A	B	C		D
NL08 (252018)	2.61	2.83	2.25	8	4	3.5	0.25	2	178	60	12	1.5	2,000
NL10 (322522)	2.94	3.64	2.52	8	4	3.5	0.2	1	178	60	10	1.5	2,000
NL12 (453232)	3.64	5.14	3.6	12	8	5.5	0.3	1	250	80	14	1.5	500
NL20(565050)	4.9	5.65	5.3	16.15	12.2	5.5	0.5	2	330	80	20	2	1,000

Wound Chip Inductors (Ferrite) – NL Large Current Series

1-1 Mechanical Performance

No	Item	Specification	Test Method
1-1-1	Vibration	Appearance: No damage L change: within±10% Q change: within±30% RDC: within specification	Test device shall be soldered on the substrate Oscillation Frequency: 10 to 55 to 10Hz for 1min Amplitude: 1.5mm Time: 2hrs for each axis (X, Y & Z), total 6hrs
1-1-2	Resistance to Soldering Heat	Appearance: No damage	Pre-heating: 150°C, 1min Solder Composition: Sn/Pb = 63/37 Solder Temperature: 260±5°C Immersion Time: 10±1sec
1-1-3	Solderability	The electrodes shall be at least 90% covered with new solder coating	Pre-heating: 150°C, 1min Solder Composition: Sn/Pb = 63/37 Solder Temperature: 230±5°C Immersion Time: 4±1sec

1-2 Environmental Performance

No	Item	Specification	Test Method															
1-2-1	Temperature Cycle	Appearance: No damage L change: within±10% Q change: within±30% RDC: within specification	One cycle: <table border="1"> <thead> <tr> <th>Step</th> <th>Temperature (°C)</th> <th>Time (min)</th> </tr> </thead> <tbody> <tr> <td>1</td> <td>-25±3</td> <td>30</td> </tr> <tr> <td>2</td> <td>25±2</td> <td>3</td> </tr> <tr> <td>3</td> <td>85±3</td> <td>30</td> </tr> <tr> <td>4</td> <td>25±2</td> <td>3</td> </tr> </tbody> </table> <p>Total: 100cycles Measured after exposure in the room condition for 24hrs</p>	Step	Temperature (°C)	Time (min)	1	-25±3	30	2	25±2	3	3	85±3	30	4	25±2	3
Step	Temperature (°C)	Time (min)																
1	-25±3	30																
2	25±2	3																
3	85±3	30																
4	25±2	3																
1-2-2	Humidity Resistance		Temperature: 40±2°C Relative Humidity: 90 ~ 95% Time: 1,000hrs Measured after exposure in the room condition for 24hrs															
1-2-3	High Temperature Resistance		Temperature: 85±3°C Relative Humidity: 20% Applied Current: Rated Current Time: 1,000hrs Measured after exposure in the room condition for 24hrs															
1-2-4	Low Temperature Resistance		Temperature: -25±3°C Relative Humidity: 0% Time: 1,000hrs Measured after exposure in the room condition for 24hrs															