

# Power Film Capacitors - Screw/Stud Terminals

**multicomp** PRO

**RoHS  
Compliant**



## Features

- Conduction cooled
- Polypropylene dielectric
- Self-healing
- Operating frequency up to 700KHz
- Maximum operating core temperature 85°C
- Capacitance tolerance  $\pm 10\%$
- Flame retardant UL94- V0

## Standard Capacitor Values

Part Number	Rated Voltage Vrms	Nominal Capacitance $\mu\text{F}$ at 1kHz	Max Current Irms	Max Power Kvar	Frequency kHz	ESR $\text{m}\Omega$	Dimensions mm			Terminal Style
							B	H	L	
MP004088	450	2.4	500	200	65-85	0.3	30.2	30	68	SM
MP004082		2.4	300		199-286	0.9				SP
MP004081	600	1.33	300		232-422	1				SP
MP004087		1.33	450		65-120	0.4				SM
MP004079	700	0.66	250		636-994	1.5				SM
MP004080			250		318-498	1.2				SP
MP004086	800	0.5	450		74-134	0.4				SP
MP004085			400		98-193	0.4				SM
MP004083		0.33	300		150-216	0.8				SP
MP004084		0.33	350		98-194	0.6				SM

## Capacitor Drawing and Terminal Style

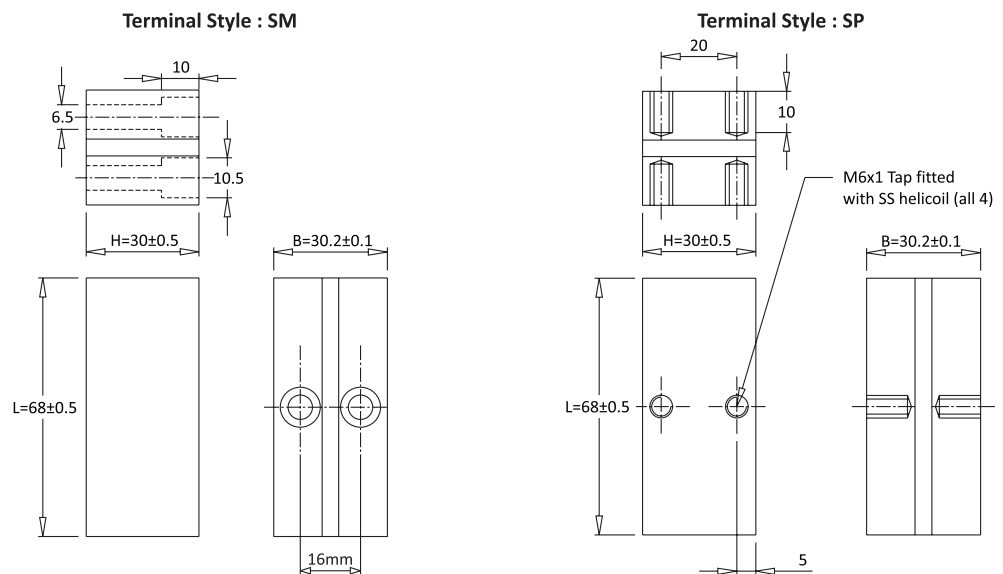

Dimensions : Millimetres

Tightening torque 15Nm max.

Newark.com/multicomp-pro  
Farnell.com/multicomp-pro  
Element14.com/multicomp-pro

**multicomp** PRO

# Power Film Capacitors - Screw/Stud Terminals

**multicomp** PRO

## Frequency Derating

—◆— Voltage    —■— Current    —▲— Power

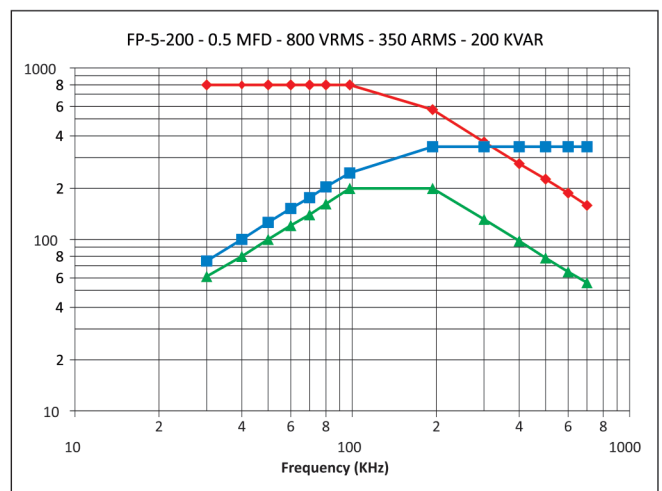
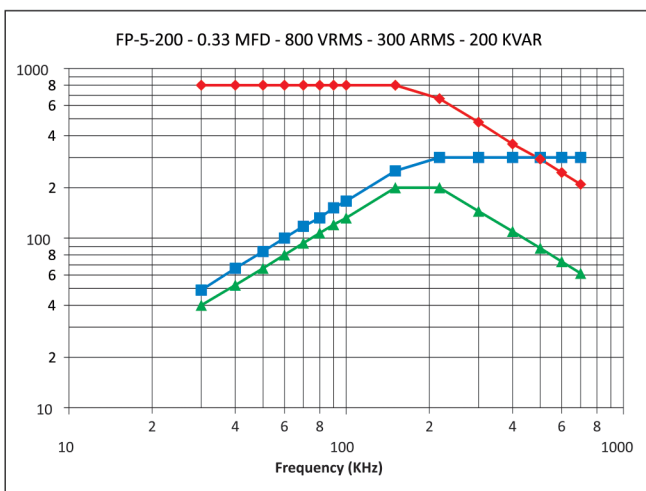
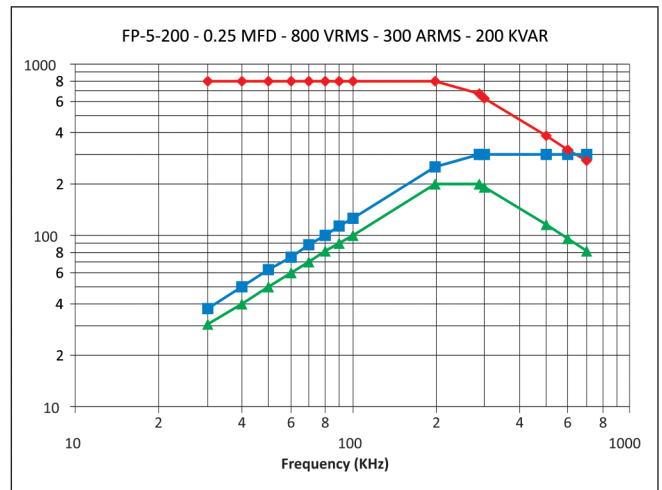
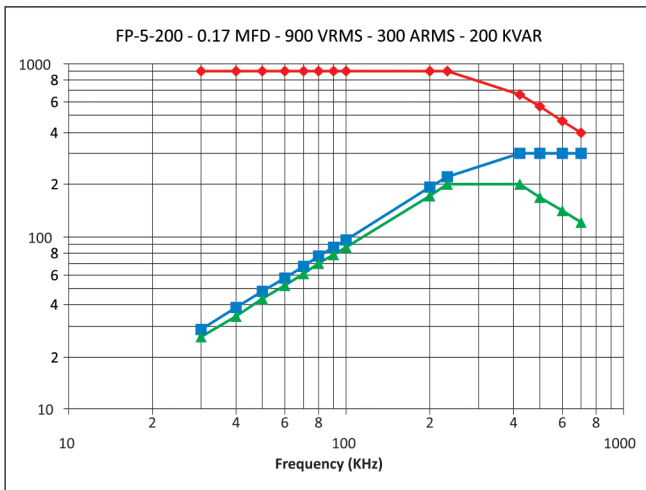
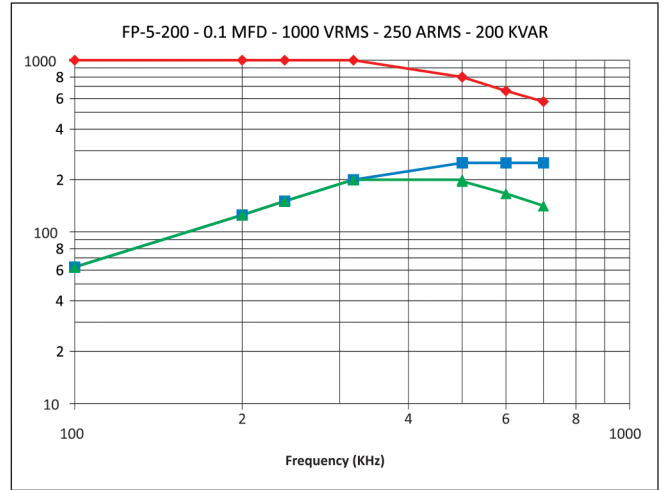
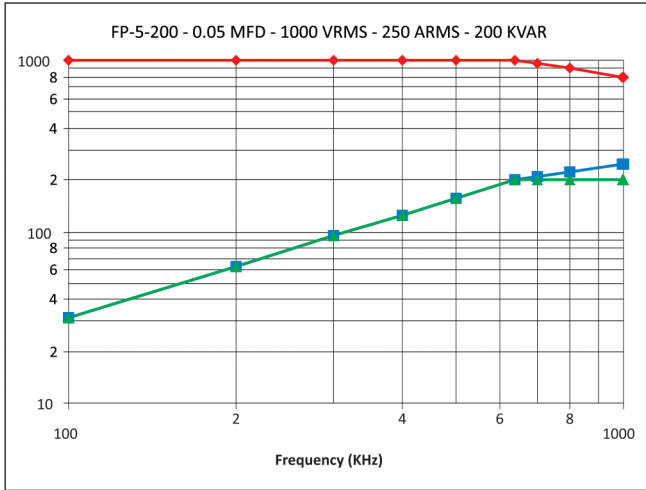

Newark.com/multicomp-pro  
Farnell.com/multicomp-pro  
Element14.com/multicomp-pro

**multicomp** PRO

# Power Film Capacitors - Screw/Stud Terminals

**multicomp** PRO

## Frequency Derating

—●— Voltage    —■— Current    —▲— Power

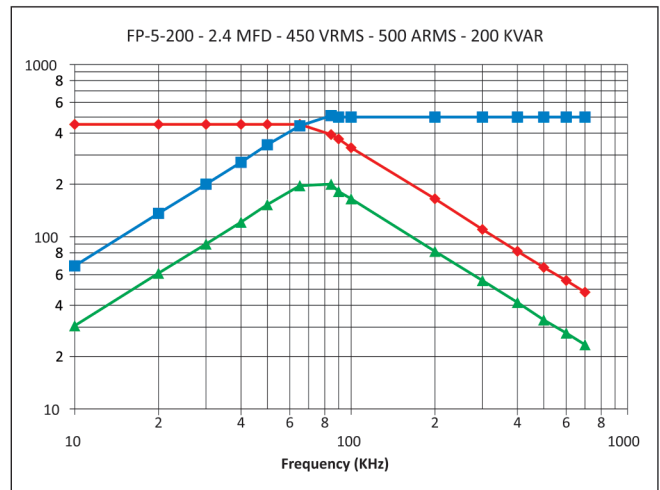
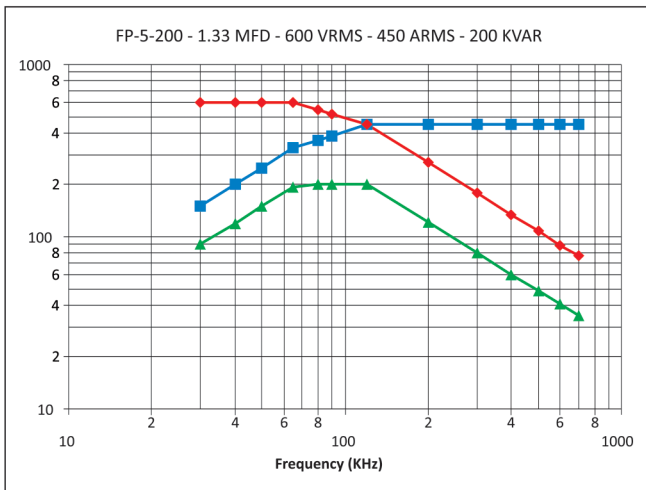
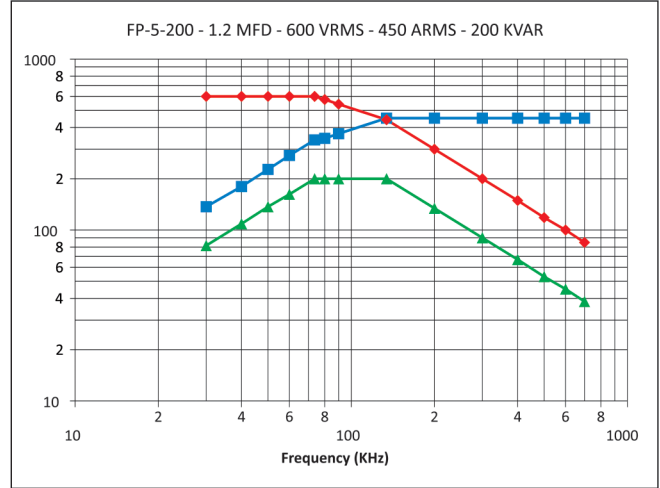
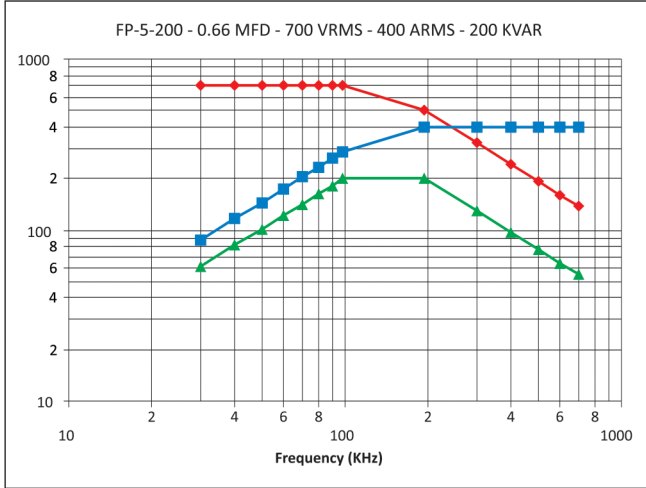

**Important Notice :** This data sheet and its contents (the "Information") belong to the members of the AVNET group of companies (the "Group") or are licensed to it. No licence is granted for the use of it other than for information purposes in connection with the products to which it relates. No licence of any intellectual property rights is granted. The Information is subject to change without notice and replaces all data sheets previously supplied. The Information supplied is believed to be accurate but the Group assumes no responsibility for its accuracy or completeness, any error in or omission from it or for any use made of it. Users of this data sheet should check for themselves the Information and the suitability of the products for their purpose and not make any assumptions based on information included or omitted. Liability for loss or damage resulting from any reliance on the Information or use of it (including liability resulting from negligence or where the Group was aware of the possibility of such loss or damage arising) is excluded. This will not operate to limit or restrict the Group's liability for death or personal injury resulting from its negligence. Multicomp Pro is the registered trademark of Premier Farnell Limited 2019.

Newark.com/multicomp-pro  
Farnell.com/multicomp-pro  
Element14.com/multicomp-pro

**multicomp** PRO