

Power Film Capacitors - Screw/Stud Terminals

multicomp PRO

**RoHS
Compliant**



Features

- Conduction cooled
- 100% leak proof
- Polypropylene dielectric
- Self-healing
- Operating frequency up to 100kHz
- Maximum operating core temperature 85°C
- Capacitance tolerance $\pm 10\%$
- Flame retardant UL94- V0

Standard Capacitor Values

Part Number	Rated Voltage Vrms	Nominal Capacitance μF at 1kHz	Max Current Irms	Max Power Kvar	Frequency kHz	ESR m Ω	Dimensions mm		
							$\varnothing\text{D}$	H	$\varnothing\text{d}$
MP004030	500	21	1000	500	15	0.4	80	71.5	60
MP004028	700	6.3	1000		26-51	0.8	80		
MP004029	700	10	1000		16-32	0.6	95		
MP004027	750	3.3	800		43-62	1	80		
MP004026	1100	1.4	600		46-83	1.2	80		

Capacitor Drawing and Terminal Style

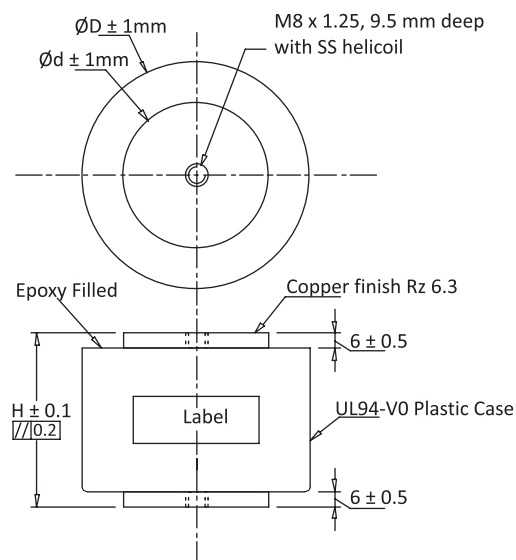

Tightening torque 15Nm max.

Dimensions : Millimetres

Newark.com/multicomp-pro
Farnell.com/multicomp-pro
Element14.com/multicomp-pro

multicomp PRO

Power Film Capacitors - Screw/Stud Terminals

multicomp PRO

Frequency Derating

—●— Voltage —■— Current —▲— Power

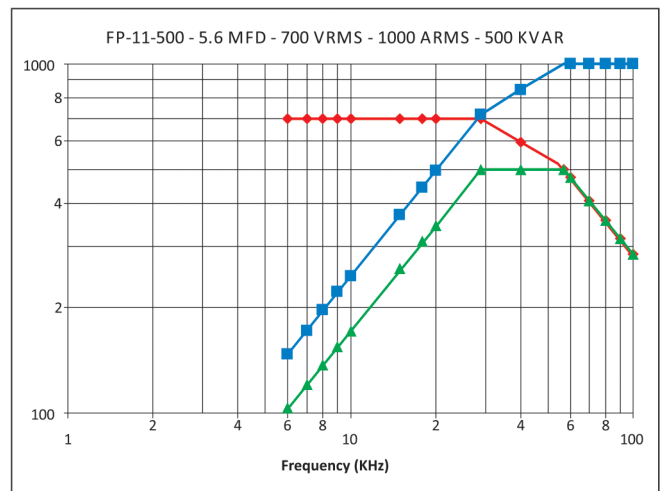
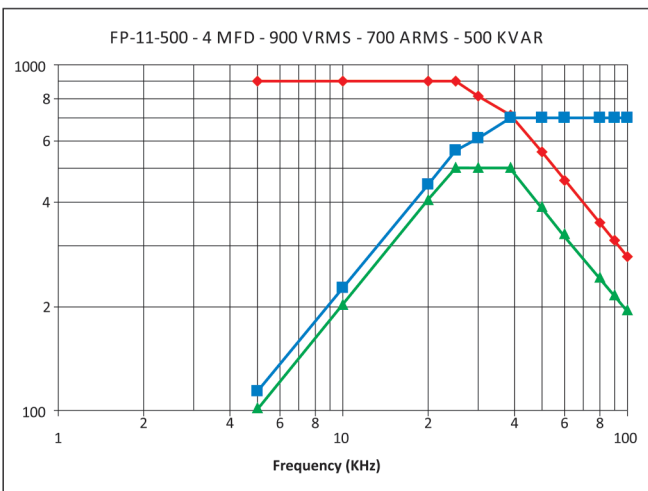
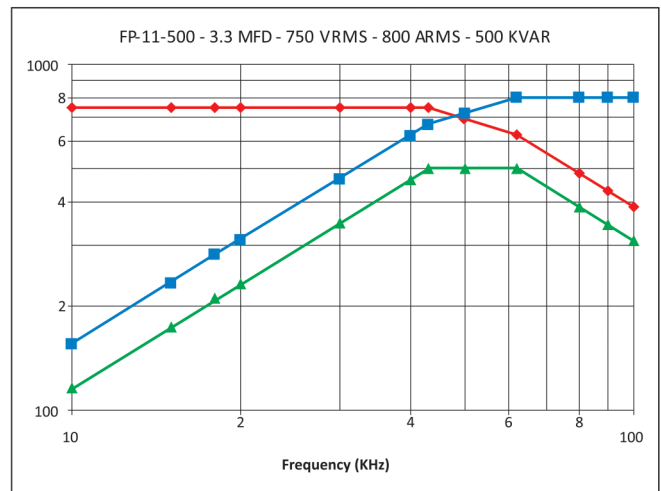
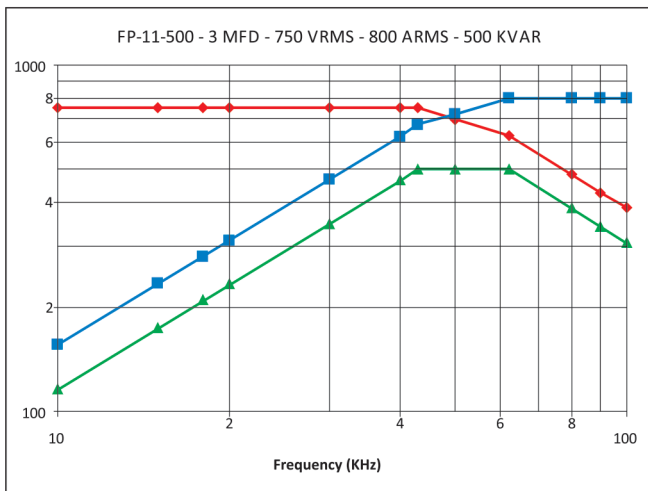
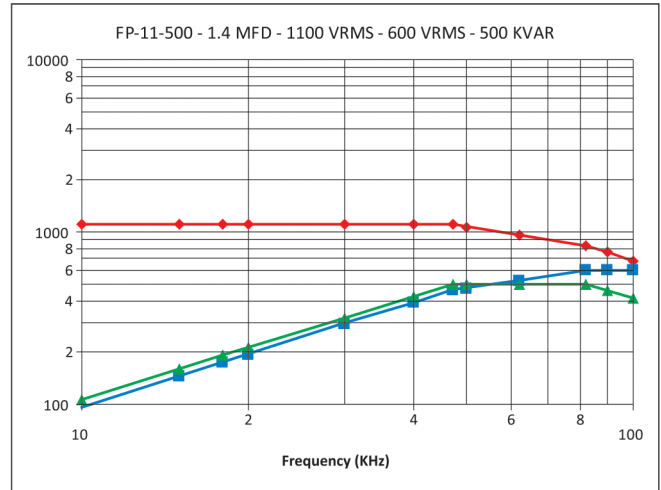
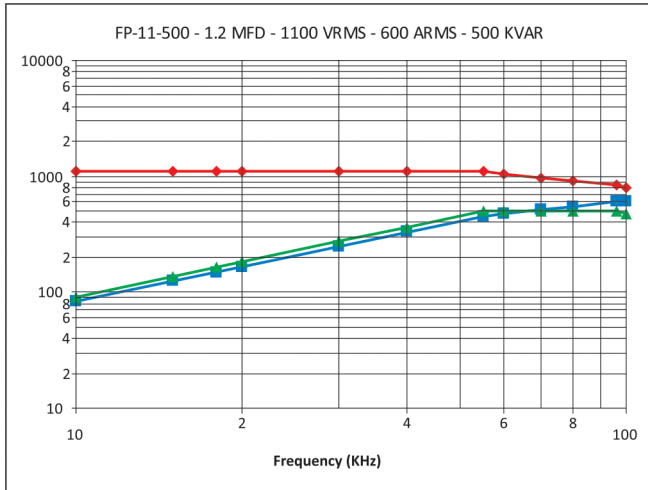

Newark.com/multicomp-pro
Farnell.com/multicomp-pro
Element14.com/multicomp-pro

multicomp PRO

Power Film Capacitors - Screw/Stud Terminals

multicomp PRO

Frequency Derating

—●— Voltage —■— Current —▲— Power

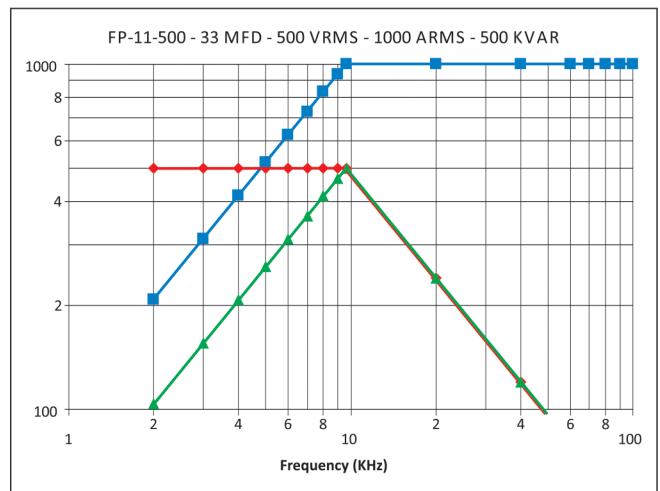
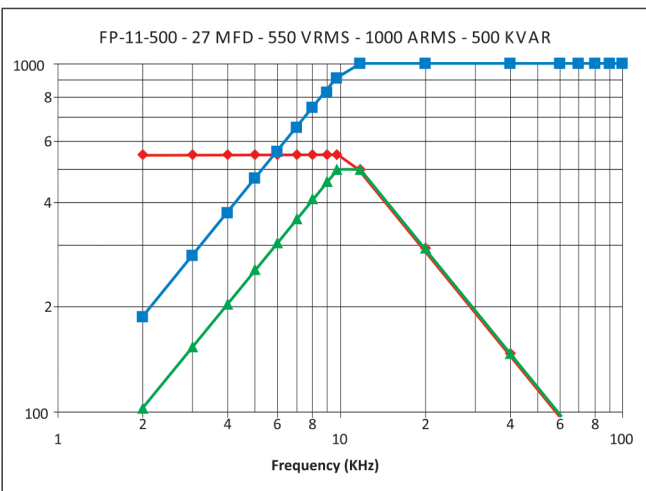
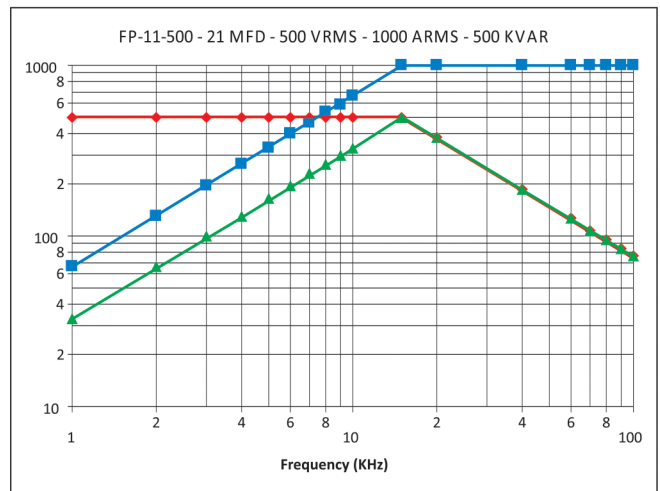
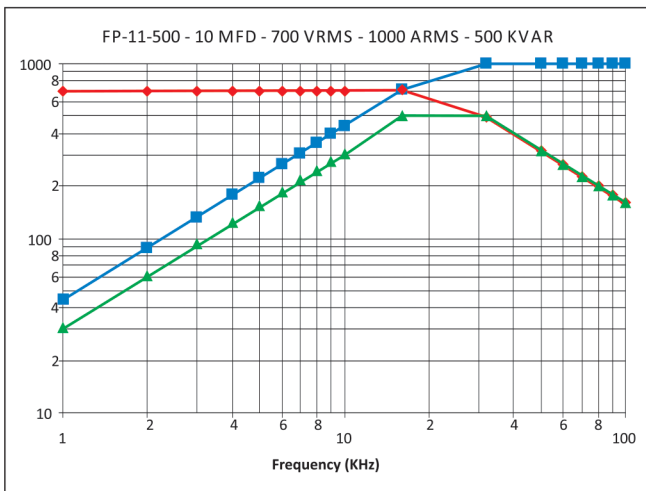
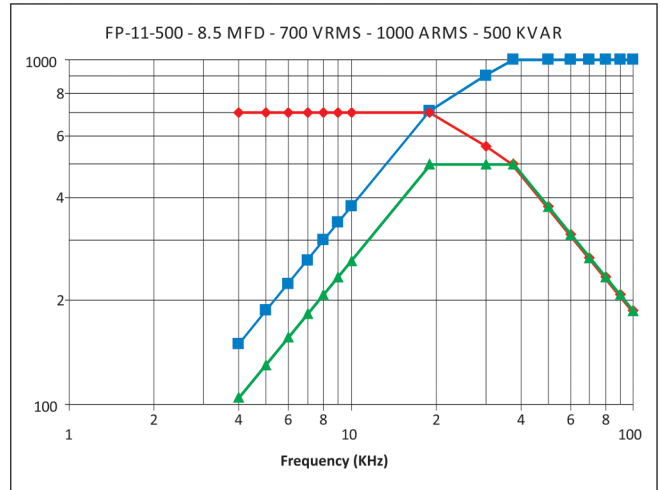
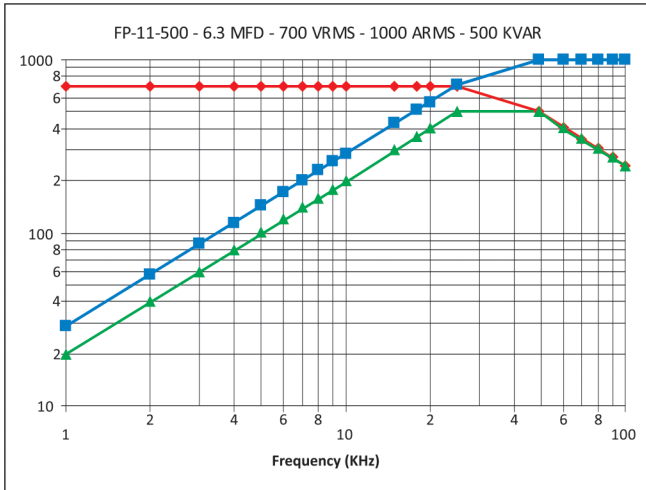

Newark.com/multicomp-pro
Farnell.com/multicomp-pro
Element14.com/multicomp-pro

multicomp PRO

Power Film Capacitors - Screw/Stud Terminals

multicomp PRO

Frequency Derating

—◆— Voltage —■— Current —▲— Power

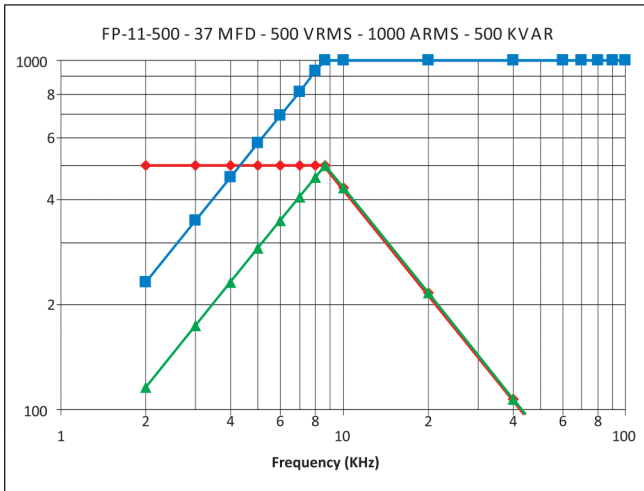

Important Notice : This data sheet and its contents (the "Information") belong to the members of the AVNET group of companies (the "Group") or are licensed to it. No licence is granted for the use of it other than for information purposes in connection with the products to which it relates. No licence of any intellectual property rights is granted. The Information is subject to change without notice and replaces all data sheets previously supplied. The Information supplied is believed to be accurate but the Group assumes no responsibility for its accuracy or completeness, any error in or omission from it or for any use made of it. Users of this data sheet should check for themselves the Information and the suitability of the products for their purpose and not make any assumptions based on information included or omitted. Liability for loss or damage resulting from any reliance on the Information or use of it (including liability resulting from negligence or where the Group was aware of the possibility of such loss or damage arising) is excluded. This will not operate to limit or restrict the Group's liability for death or personal injury resulting from its negligence. Multicomp Pro is the registered trademark of Premier Farnell Limited 2019.

Newark.com/multicomp-pro
Farnell.com/multicomp-pro
Element14.com/multicomp-pro

multicomp PRO