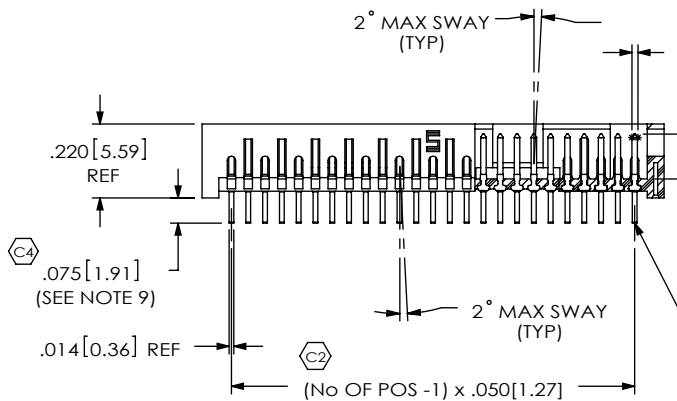
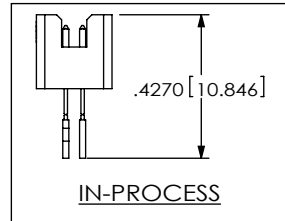

FIG. 1
-01: THROUGH HOLE

- No OF POSITIONS**
-05,-07,-10 THRU -50
(PER ROW)
- LEAD STYLE**
-01: THROUGH HOLE
(SEE FIG. 1)
-02: SURFACE MOUNT
(SEE FIG.3, SHT 2)
- PLATING SPECIFICATION**
-S: SELECTIVE (USE T-1R16-XX-S-X)
-L: LIGHT SELECTIVE (USE T-1R16-XX-L-X)
-F: FLASH GOLD (USE T-1R16-XX-F-X)
-P: GOLD FLASH PALLADIUM NICKEL
(USE T-1R16-XX-P-X)
-H: HEAVY GOLD (USE T-1R16-XX-H-X)
-FM: SELECTIVE FLASH GOLD, MATTE TIN TAIL
(USE T-1R16-XX-F-X)
-LM: SELECTIVE LIGHT GOLD, MATTE TIN TAIL
(USE T-1R16-XX-L-X)
-SM: SELECTIVE HEAVY GOLD, MATTE TIN TAIL
(USE T-1R16-XX-S-X)

- OPTION**
- A: ALIGNMENT PIN (USE TFML-XX-D-01-A)
(SEE FIG. 7, SHT 3)
 - LC: LOCKING CLIP (USE LC-05-TM) SEE NOTE 12
(SEE FIG. 9, SHT 3, N/A ON -RA OPTION)
 - P: PICK & PLACE PAD (USE PPP-04)
(AVAIL IN ALL POSITIONS, N/A
ON -RA OPTION, SEE FIG. 5, SHT 2)
 - RA: RIGHT ANGLE (LEAD STYLE -01 ONLY)
(SEE FIG. 4, SHT 2)
 - TR: TAPE & REEL
(SEE FIG. 2)(N/A ON -01 LEAD STYLE)
 - SA: STAKED ALIGNMENT PIN (USE SM-A5)
(SEE FIG. 8, SHT 3)
 - K: POLYAMIDE FILM (USE K-500-300)
(SEE FIG. 6, SHT 2) (N/A ON -RA)
 - SN: SOLDER NAIL (USE TFML-XX-D-01-SN &
WT-27-01-T) (SEE FIG. 10, SHEET 4)
(AVAILABLE ON -02 LEAD STYLE ONLY)
 - SN2: SOLDER NAIL FOR .093 BOARD
(USE TFML-XX-D-01-SN &
WT-27-02-T) (SEE FIG. 10, SHEET 4)
(AVAILABLE ON -02 LEAD STYLE ONLY)
(NOT AVAILABLE WITH -A, -LC, -RA, -SA)

ROW SPECIFICATION
-D: DOUBLE ROW



SECTION "A"-"A"

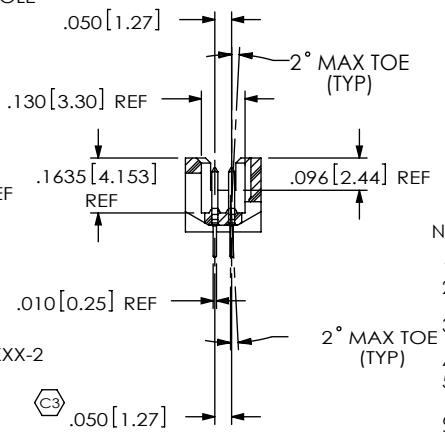

SECTION "B"-"B"

NOTES:

- ⊕ REPRESENTS A CRITICAL DIMENSION.
- COPLANARITY: POSITIONS -10 THRU -26: .004[0.10]
POSITIONS -27 THRU -50: .006[0.15].
- MANUFACTURING IN-PROCESS DIMENSION DESIGNED TO ACHIEVE FINISHED ASSEMBLY. ⊕
- MINIMUM PUSHOUT FORCE: 1.0 LB [4.4 N].
- MAXIMUM ALLOWABLE BOW: .004 INCH/INCH [0.10 MM/MM] AFTER ASSEMBLY.
- MEASURED FROM BEND.
- POSITIONS -05 AND -07 WILL ONLY HAVE ONE CLIP AT DIMENSION SHOWN; POSITIONS -10 THROUGH -24 WILL HAVE ONLY ONE CLIP AT DIMENSION SHOWN; POSITIONS -25 THROUGH -34 WILL HAVE TWO CLIPS AT DIMENSION SHOWN; POSITIONS -35 THROUGH -50 WILL HAVE THREE; CLIPS: TWO AT DIMENSION SHOWN & ONE CENTERED ON INSULATOR.
- NOTE DELETED.
- .003[0.08] MAXIMUM TERMINAL BURR
- .005[0.13] MAXIMUM HEIGHT VARIATION BETWEEN ANY TWO PINS.
- DIMENSION IS NOT APPLICABLE FOR -05 AND -07 POSITION.
- DUE TO THE HIGH AMOUNT OF INSERTION FORCE NEEDED, THE -LC OPTION IS NOT COMPATIBLE WITH AUTO PLACEMENT. SAMTEC RECOMMENDS MANUAL PLACEMENT FOR ALL ASSEMBLIES WITH THE -LC OPTION.

NO OF POS.	"A"
EVEN	.310
ODD (EXCL. -05,-07 POS)	.360
-05,-07	.113

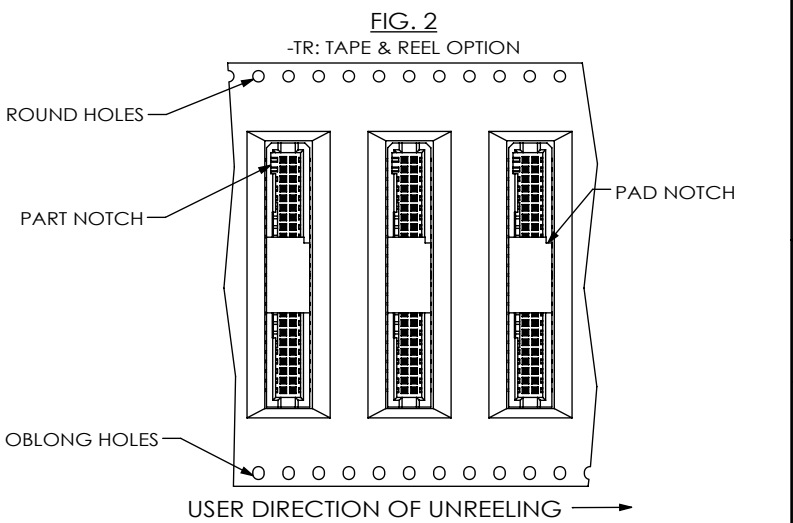

FIG. 2
-TR: TAPE & REEL OPTION

UNLESS OTHERWISE SPECIFIED, DIMENSIONS ARE IN INCHES.
TOLERANCES ARE:
DECIMALS ANGLES
.XX: ±.01 2°
.XXX: ±.005
.XXXX: ±.0020

PROPRIETARY NOTE
THIS DOCUMENT CONTAINS INFORMATION CONFIDENTIAL AND PROPRIETARY TO SAMTEC, INC. AND SHALL NOT BE REPRODUCED OR TRANSFERRED TO OTHER DOCUMENTS OR DISCLOSED TO OTHERS OR USED FOR ANY PURPOSE OTHER THAN THAT WHICH IT WAS OBTAINED WITHOUT THE EXPRESSED WRITTEN CONSENT OF SAMTEC, INC.



520 PARK EAST BLVD, NEW ALBANY, IN 47150
PHONE: 812-944-6733 FAX: 812-948-5047
e-Mail: info@SAMTEC.com code: 55322

MATERIAL:
VECTRA E130I, COLOR: BLACK
CONTACT: PHOS BRONZE, THICKNESS: .018

DO NOT SCALE DRAWING SHEET SCALE: 1:75:1

DESCRIPTION: .050 SHROUDED TERMINAL ASSEMBLY

DWG. NO. TFML-1XX-XX-XXX-D-XXX

BY: DEANP 4/8/99 SHEET 1 OF 4

FIG. 3

-02: SURFACE MOUNT
(SHOWN: TFML-125-02-XXX-D)
(SAME AS FIG. 1, UNLESS OTHERWISE STATED)

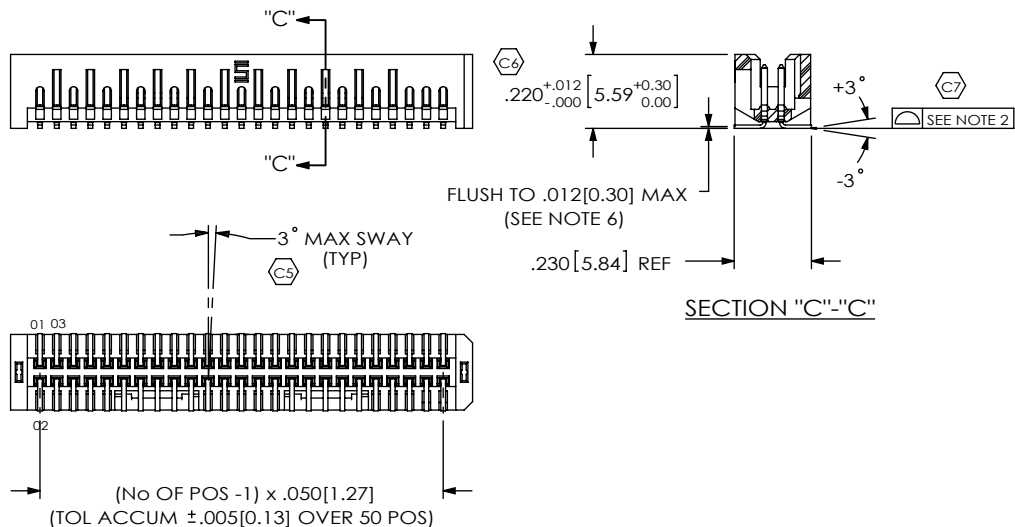

FIG. 5

-P: PICK & PLACE PAD OPTION
(SHOWN: TFML-125-02-XXX-D-P)
(SAME AS FIG. 1, UNLESS OTHERWISE STATED)
NOTCH ON PAD TO BE ON SAME END AS NOTCH IN TFM BODY

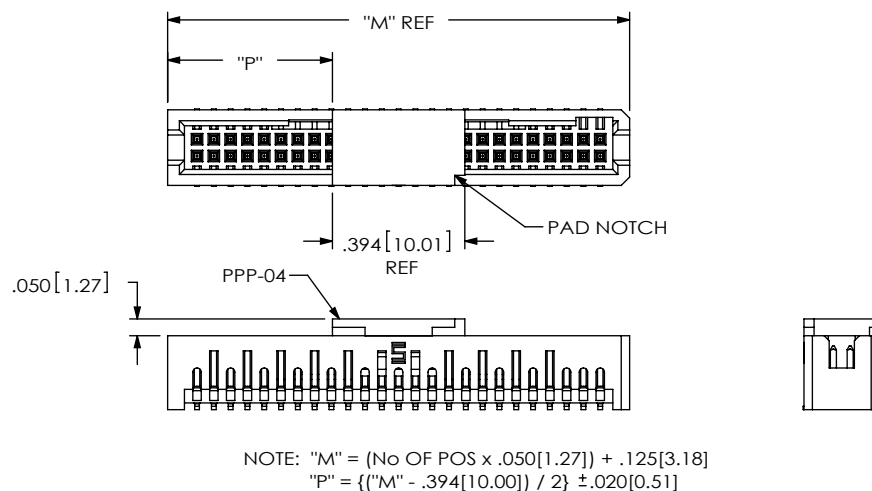

FIG. 4

-RA: RIGHT ANGLE OPTION
(SHOWN: TFML-125-01-XXX-D-RA)
(SAME AS FIG. 1, UNLESS OTHERWISE STATED)

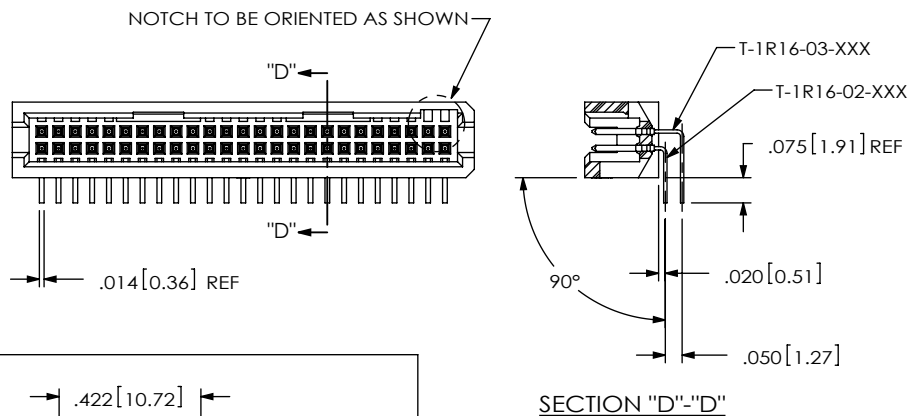
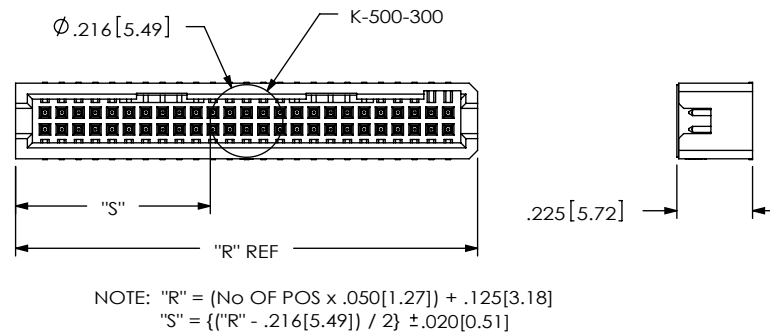

FIG. 6

-K: POLYAMIDE FILM PAD OPTION
(SHOWN: TFML-125-02-XXX-D-K)
(SAME AS FIG. 1, UNLESS OTHERWISE STATED)



c:\enterprisevault\DWG\MISC\MKTG\TFML-1XX-XX-XXX-D-XXX-MKT.SLDDRW

PROPRIETARY NOTE

THIS DOCUMENT CONTAINS INFORMATION CONFIDENTIAL AND PROPRIETARY TO SAMTEC, INC. AND SHALL NOT BE REPRODUCED OR TRANSFERRED TO OTHER DOCUMENTS OR DISCLOSED TO OTHERS OR USED FOR ANY PURPOSE OTHER THAN THAT WHICH IT WAS OBTAINED WITHOUT THE EXPRESSED WRITTEN CONSENT OF SAMTEC, INC.

DO NOT SCALE DRAWING

SHEET SCALE: 1:75:1



520 PARK EAST BLVD, NEW ALBANY, IN 47150
PHONE: 812-944-6733 FAX: 812-948-5047
e-Mail: info@SAMTEC.com code: 55322

DESCRIPTION:
.050 SHROUDED TERMINAL ASSEMBLY

DWG. NO.
TFML-1XX-XX-XXX-D-XXX

BY: DEANP 4/8/99 SHEET 2 OF 4

PACKAGING VIEWS

PARTS TO BE POSITIONED WITH POLARIZING NOTCH FACING THE SAMTEC LOGO AND ARROW.

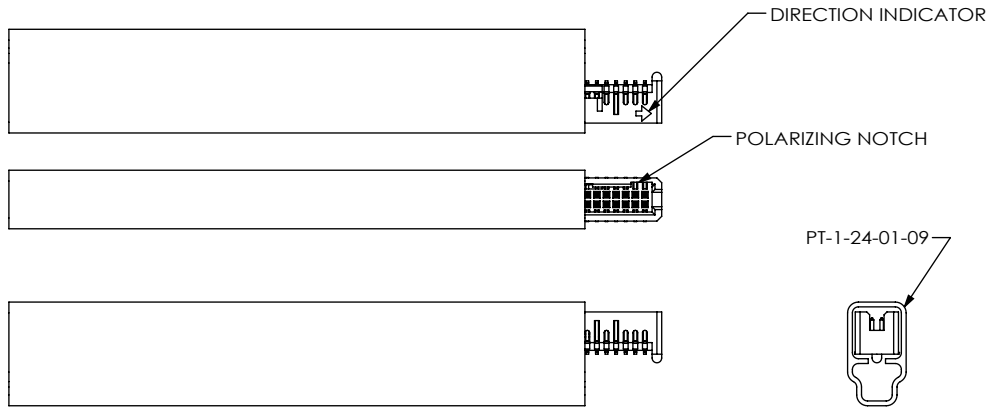

PARTS TO BE POSITIONED WITH TAILS FACING LOGO SIDE OF TUBE AND POLARIZING NOTCH ORIENTED AS SHOWN

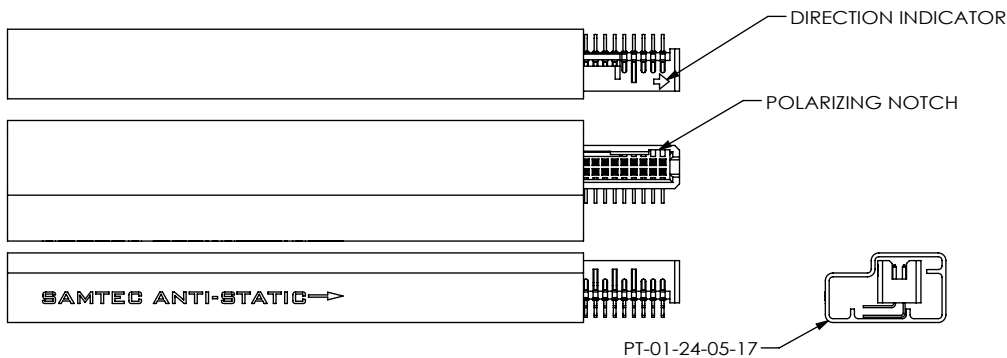

POSITION PARTS WITH POLARIZING NOTCH ORIENTED AS SHOWN

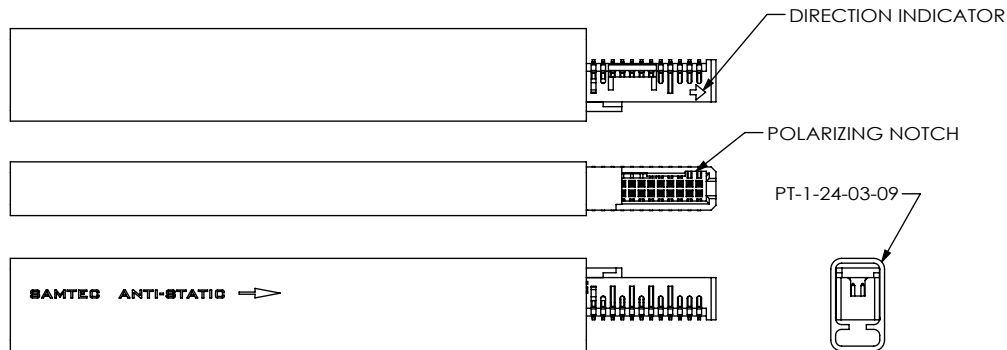

LEAD STYLE	PACKAGING TUBE	PLUG
-RA ONLY	PT-1-24-05-17	TP-07
-01,-02 EXCEPT -RA OR -P	PT-1-24-01-09	TP-24
-01-P,-02-P	PT-1-24-03-09	TP-03

FIG. 7

-A: ALIGNMENT PIN OPTION
(SHOWN: TFML-125-02-XXX-D-A)
(SAME AS FIG. 1, UNLESS OTHERWISE STATED)
-NOT AVAILABLE WITH -RA

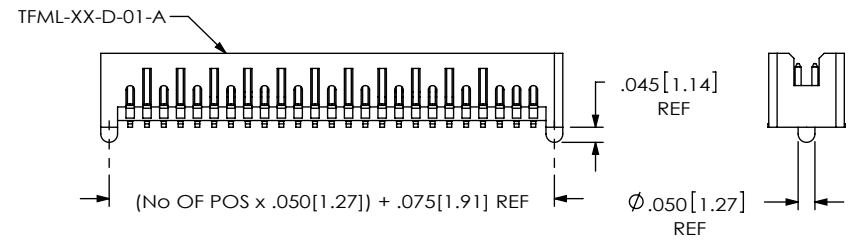

FIG. 8

-SA: STAKED ALIGNMENT PIN OPTION
(SHOWN: TFML-125-02-XXX-D-SA)
(SAME AS FIG. 1, UNLESS OTHERWISE STATED)
-NOT AVAILABLE ON -RA

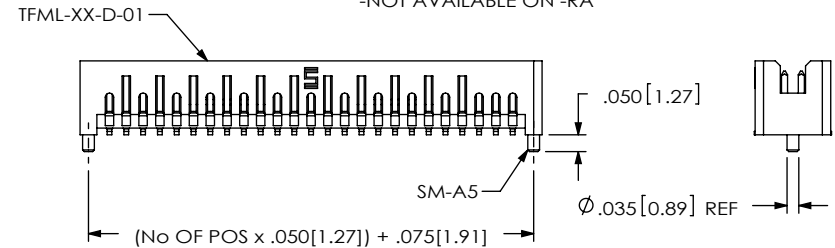
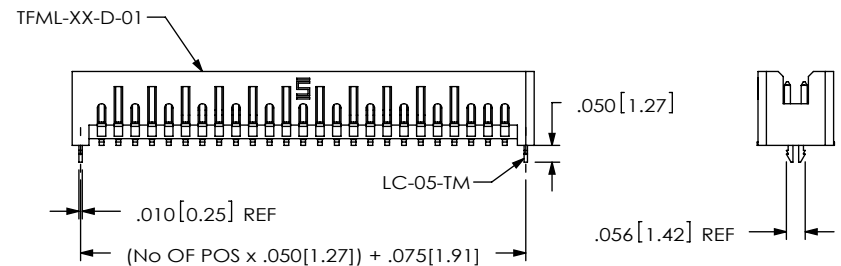

FIG. 9

-LC: LOCKING CLIP OPTION
(SHOWN: TFML-125-02-XXX-D-LC)
(SAME AS FIG. 1, UNLESS OTHERWISE STATED)
-NOT AVAILABLE ON -RA



c:\enterprise\dwg\MISC\MKTG\TFML-1XX-XX-XXX-D-XXX-MKT.SLDDRW

PROPRIETARY NOTE

THIS DOCUMENT CONTAINS INFORMATION CONFIDENTIAL AND PROPRIETARY TO SAMTEC, INC. AND SHALL NOT BE REPRODUCED OR TRANSFERRED TO OTHER DOCUMENTS OR DISCLOSED TO OTHERS OR USED FOR ANY PURPOSE OTHER THAN THAT WHICH IT WAS OBTAINED WITHOUT THE EXPRESSED WRITTEN CONSENT OF SAMTEC, INC.

DO NOT SCALE DRAWING

SHEET SCALE: 1.75:1



520 PARK EAST BLVD, NEW ALBANY, IN 47150
PHONE: 812-944-6733 FAX: 812-948-5047
e-Mail: info@SAMTEC.com code: 55322

DESCRIPTION:
.050 SHROUDED TERMINAL ASSEMBLY

DWG. NO.
TFML-1XX-XX-XXX-D-XXX

BY: DEANP 4/8/99 SHEET 3 OF 4

FIG. 10
 -SNX: SOLDER NAIL
 (SHOWN: TFML-125-02-XXX-D-SN)
 (SAME AS FIG. 1, UNLESS OTHERWISE STATED)
 (ONLY AVAILABLE ON -02 LEAD STYLE)

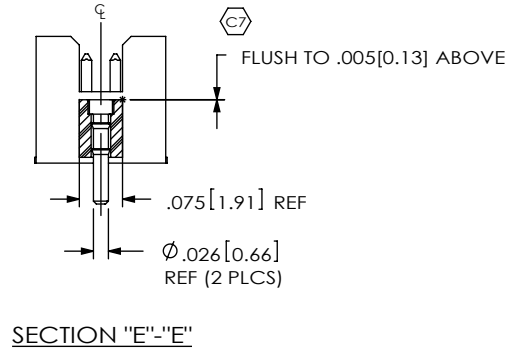
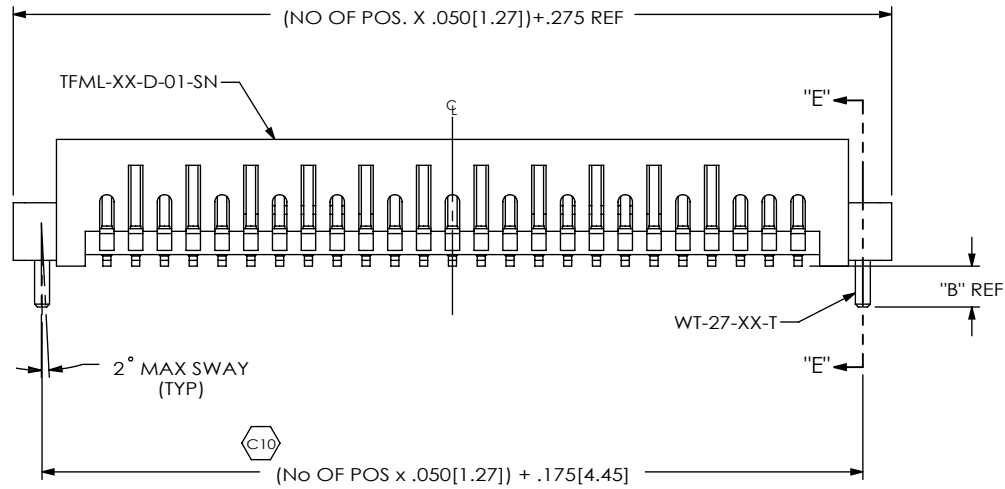

OPTION	"B"
-SN	.071[1.80]
-SN2	.106[2.69]

PROPRIETARY NOTE
 THIS DOCUMENT CONTAINS INFORMATION CONFIDENTIAL AND PROPRIETARY TO SAMTEC, INC. AND SHALL NOT BE REPRODUCED OR TRANSFERRED TO OTHER DOCUMENTS OR DISCLOSED TO OTHERS OR USED FOR ANY PURPOSE OTHER THAN THAT WHICH IT WAS OBTAINED WITHOUT THE EXPRESSED WRITTEN CONSENT OF SAMTEC, INC.

DO NOT SCALE DRAWING

SHEET SCALE: 3:1

samtec

520 PARK EAST BLVD, NEW ALBANY, IN 47150
 PHONE: 812-944-6733 FAX: 812-948-5047
 e-Mail: info@SAMTEC.com code: 55322

DESCRIPTION:
 .050 SHROUDED TERMINAL ASSEMBLY

DWG. NO.
TFML-1 XX-XX-XXX-D-XXX

BY: DEANP 4/8/99 SHEET 4 OF 4