

Surface
SMT
Mount

.050" MICRO HEADER FTSH SERIES

SPECIFICATIONS

For complete specifications and recommended PCB layouts see www.samtec.com?FTSH

Insulator Material: Black Liquid Crystal Polymer
Terminal Material: Phosphor Bronze
Plating: Sn or Au over 50µ" (1,27µm) Ni
Current Rating: 1.75A @ 80°C ambient
Operating Temp Range: -55°C to +125°C

Processing:
Max Processing Temp: 230°C for 60 seconds, or 260°C for 20 seconds 3x
Lead-Free Solderable: Yes
SMT Lead Coplanarity: (0,10mm) .004" max (02-25) (0,15mm) .006" max (26-50)

Mates with:
FFSD, CLP, FLE, SFMC, SFMH

APPLICATIONS



ALSO AVAILABLE

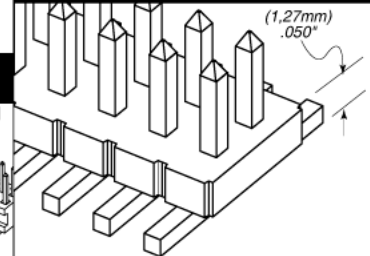

Ultra-low profile option available. End Shrouds available. Call for FTS Series specifications.

APPLICATION SPECIFIC OPTION

Molded pick-and-place pads, latches, single row option and straddle mount leads available. Call Samtec.

OPTIONS

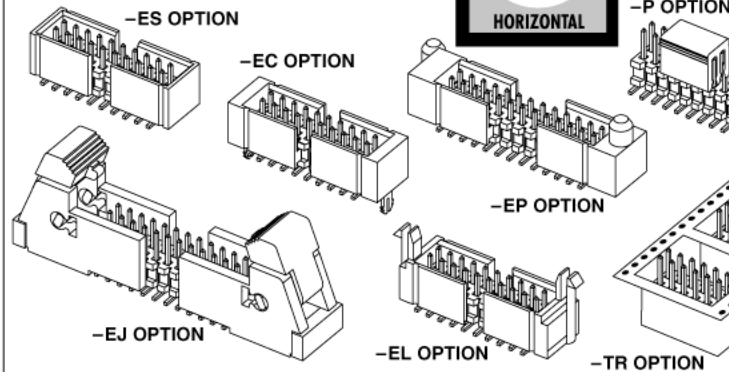

FTSH

1

NO. PINS PER ROW

LEAD STYLE

02 thru 50

- 01**
= (3,05) .120" Post (Mates with FFSD, FLE)
- 02**
= (1,91) .075" Post (Mates with FLE)
- 03**
= (1,65) .065" Post (Mates with CLP -D)
- 04**
= (3,81) .150" Post (Mates with SFMC, SFMH)

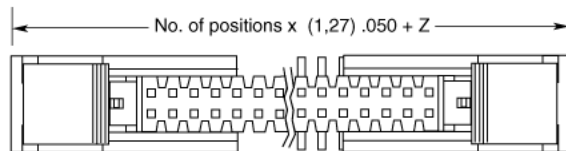
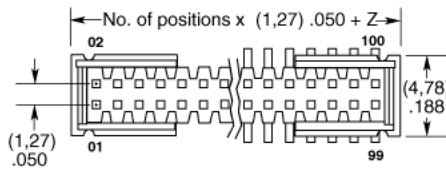

LEAD STYLE	A
-01	(3,05) .120
-02	(1,91) .075
-03	(1,65) .065
-04	(3,81) .150

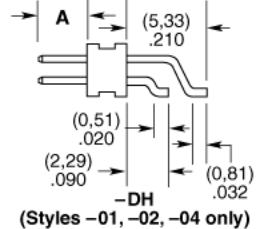

OPTION	Z
-ES	(2,57) .101
-EJ	(15,77) .621
-EC	(3,33) .131
-EP	(5,87) .231
-EL	(6,53) .257

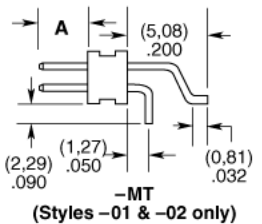
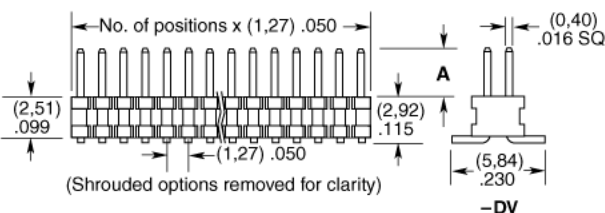

TAPE & REEL AVAILABILITY
 No tooling charges.
 125 piece minimum order.
 Order any quantity above minimum.
 In-house design, manufacture.
 Quick turn-around.
 Call Samtec for specifications and ordering information.

Note: Some sizes, styles and options are non-standard, non-returnable.

Note: See SFM/TFM for positive alignment feature.

Due to technical progress, all designs, specifications and components are subject to change without notice.

WWW.SAMTEC.COM

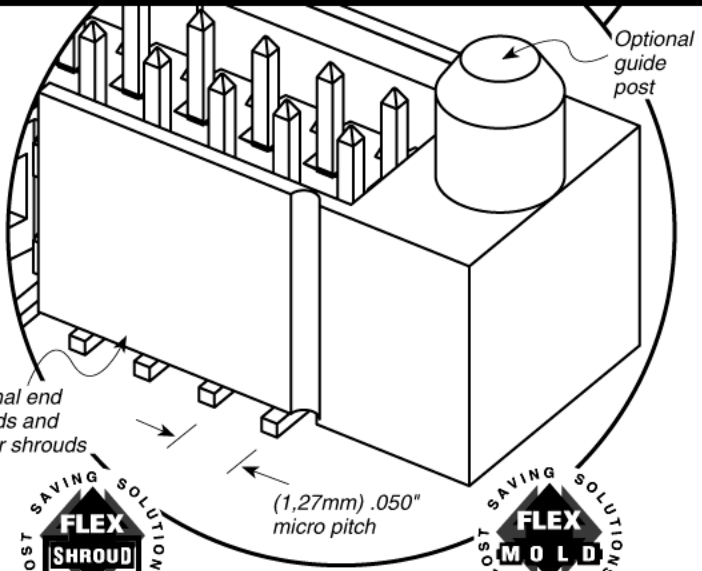
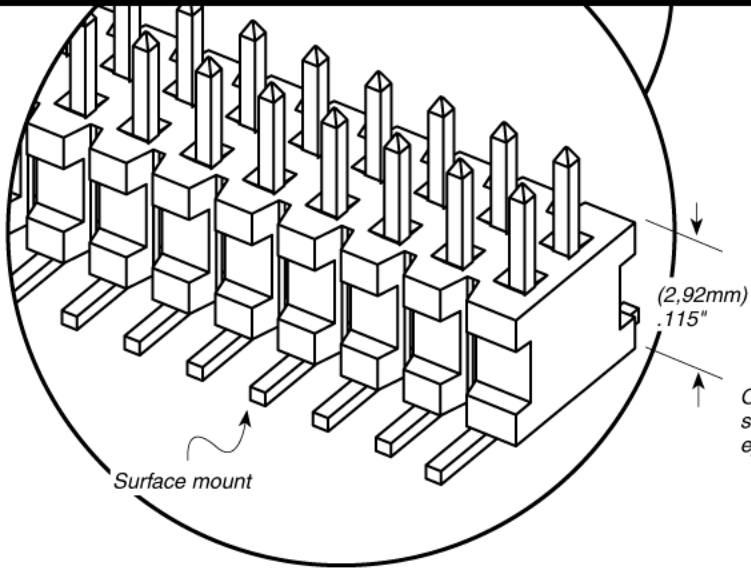
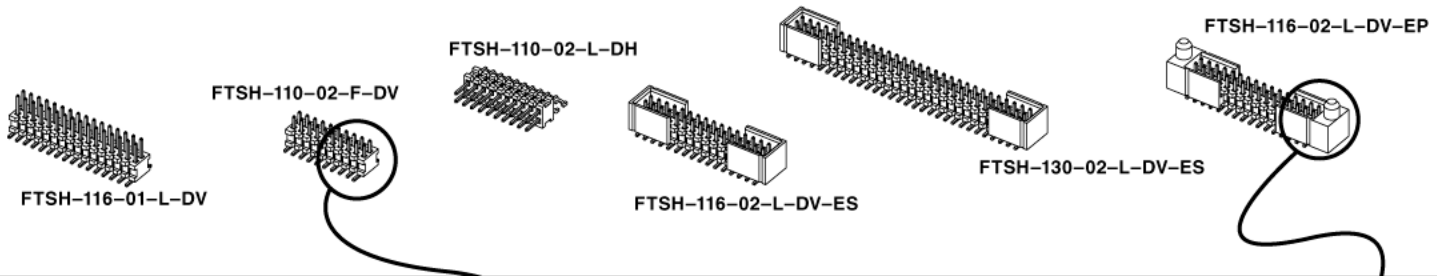

PLATING OPTION

- L**
= 10µ" (0,25µm) Gold on post, Matte Tin on tail
- F**
= Gold flash on post, Matte Tin on tail

TAIL OPTION

- DV**
= Double Vertical
- DH**
= Double Horizontal (Styles -01, -02 & -04 only)
- MT**
= Mixed Technology (Styles -01, -02 & -04 only)

FLEX SHROUD OPTIONS

- (Style -02 & -03 only, -DH not available)
9 pins/row minimum
- ES**
= End Shroud
- EC**
= End Shroud with Locking Clip
- EP**
= End Shroud with Guide Post
- EL**
= End Shroud with Board Lock (Boards are positively locked and cannot be unmated)
- EJ**
= Ejector Shroud (Style -01 only)
-DH & -MT not available
10 pins/row minimum
25 pins/row maximum

OTHER OPTIONS

- K**
= Mating Shroud (For mating with FFSD Styles -01 only, 05, 08, 10, 13, 17, 20 & 25 pins/row only, 13, 17, 20 & 25 only with shrouds)
- A**
= Alignment Pin (-DV 3 positions min.) (-DH 5 positions min.) (Metal or plastic at Samtec discretion)
- C**
= (4,00mm) .157" DIA Polyimide film Pick & Place Pad (-DH only)
- P**
= Pick & Place Pad (-DV 4 positions min.) (-DH & -MT not available)
- TR**
= Tape & Reel Packaging (Tail option -DV & -DH only)
Flex Shroud options not available except -ES & -EJ

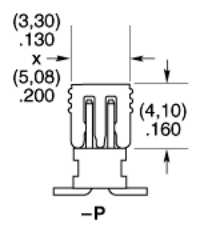
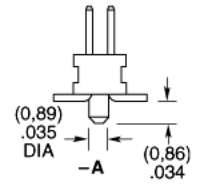
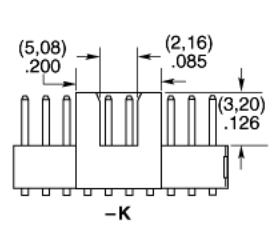
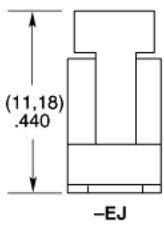
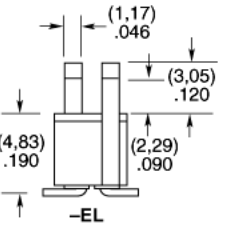
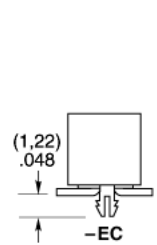
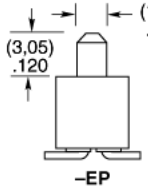
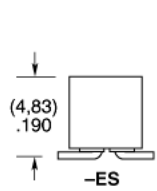

Due to technical progress, all designs, specifications and components are subject to change without notice.

WWW.SAMTEC.COM