

TL514M DUAL DIFFERENTIAL COMPARATOR WITH STROBE

D999, OCTOBER 1977—REVISED MARCH 1988

- Fast Response Times
- High Differential Voltage Amplification
- Low Offset Characteristics
- Outputs Compatible with Most TTL Circuits

description

The TL514 is an improved version of the TL720 dual high-speed voltage comparator. When compared with the TL720, these circuits feature higher amplification (typically 33,000) due to an extra amplification stage, increased accuracy because of lower offset characteristics, and greater flexibility with the addition of a strobe to each comparator. Since the output cannot be more positive than the strobe, a low-level input at the strobe will cause the output to go low regardless of the differential input.

These circuits are especially useful in applications requiring an amplitude discriminator, memory sense amplifier, or a high-speed limit detector. The TL514M is characterized for operation over the full military temperature range of -55°C to 125°C .

symbol (each comparator)

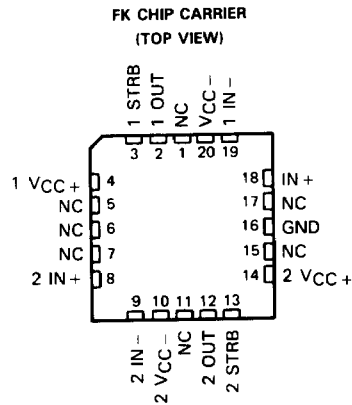
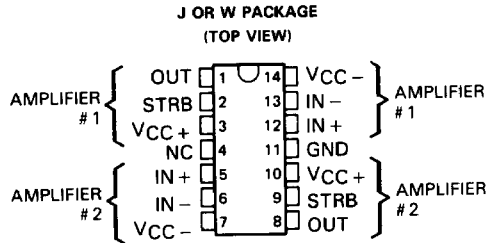
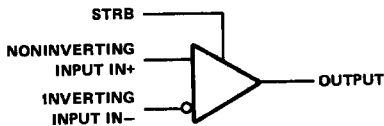

NC -- No internal connection

3
Voltage Comparators

TL514M DUAL DIFFERENTIAL COMPARATOR WITH STROBE

schematic (each comparator)

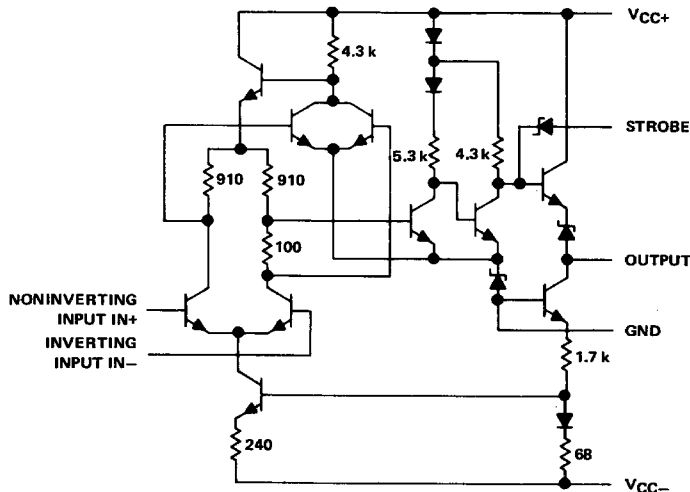

Resistor values shown are nominal in ohms.

3

Voltage Comparators

absolute maximum ratings over operating free-air temperature range (unless otherwise noted)

Supply voltage V_{CC+} (see Note 1)	14 V
Supply voltage V_{CC-} (see Note 1)	-7 V
Differential input voltage (see Note 2)	± 5 V
Input voltage (any input, see Note 1)	± 7 V
Strobe voltage (see Note 1)	6 V
Peak output current ($t_W \leq 1$ s)	10 mA
Continuous total dissipation (either comparator or both together)	See Dissipation Rating Table
Operating free-air temperature range	-55°C to 125°C
Storage temperature range	-65°C to 150°C
Case temperature for 60 seconds: FK package	260°C
Lead temperature 1,6 mm (1/16 inch) from case for 60 seconds: J or W package	300°C

- NOTES: 1. All voltage values, except differential voltages, are with respect to the network ground terminal.
2. Differential voltages are at the noninverting input terminal with respect to the inverting input terminal.

DISSIPATION RATING TABLE

PACKAGE	$T_A \leq 25^\circ\text{C}$ POWER RATING	DERATING FACTOR	DERATE ABOVE T_A	$T_A = 125^\circ\text{C}$ POWER RATING
FK	600 mW	11.0 mW/°C	95°C	275 mW
J	600 mW	11.0 mW/°C	95°C	275 mW
W	600 mW	8.0 mW/°C	75°C	200 mW

TL514M DUAL DIFFERENTIAL COMPARATOR WITH STROBE

electrical characteristics at specified free-air temperature, $V_{CC+} = 12\text{ V}$, $V_{CC-} = -6\text{ V}$

PARAMETER	TEST CONDITIONS†	MIN	TYP	MAX	UNIT	
		25°C				
V_{IO} Input offset voltage	$R_S \leq 20\ \Omega$, See Note 4	0.6		2	mV	
		-55°C to 125°C				
α_{VIO} Average temperature coefficient of input offset voltage	$R_S = 50\ \Omega$, See Note 4	3		10	$\mu\text{V}/^\circ\text{C}$	
		25°C to 125°C				
I_{IO} Input offset current	See Note 4	0.75		3	μA	
		-55°C				
		125°C				
α_{IIO} Average temperature coefficient of input offset current	See Note 4	15		75	$\text{nA}/^\circ\text{C}$	
		25°C to 125°C				
I_{IB} Input bias current	See Note 4	7		15	μA	
		-55°C				
$I_{IH(S)}$ High-level strobe current	$V_{(\text{strobe})} = 5\text{ V}$, $V_{ID} = -5\text{ mV}$	±100			μA	
$I_{IL(S)}$ Low-level strobe current	$V_{(\text{strobe})} = -100\text{ mV}$, $V_{ID} = 5\text{ mV}$	-1		-2.5	mA	
V_{ICR} Common-mode input voltage range	$V_{CC} = -7\text{ V}$	±5			V	
V_{ID} Differential input voltage range		±5			V	
AVD Large-signal differential voltage amplification	No load, $V_O = 0$ to 2.5 V	12.5		33	V/mV	
		-55°C to 125°C				
V_{OH} High-level output voltage	$V_{ID} = 5\text{ mV}$, $I_{OH} = 0$	4 [§]		5	V	
		-55°C to 125°C				
V_{OL} Low-level output voltage	$V_{ID} = -5\text{ mV}$, $I_{OL} = 0$	-1		-0.5 [§]	0 [‡]	V
		-55°C to 125°C				
	$V_{(\text{strobe})} = 0.3\text{ V}$, $V_{ID} = 5\text{ mV}$, $I_{OL} = 0$	-1		0 [‡]	V	
I_{OL} Low-level output current	$V_{ID} = -5\text{ mV}$, $V_O = 0$	2		2.4	mA	
		-55°C				
		125°C				
r_o Output resistance	$V_O = 1.4\text{ V}$	200			Ω	
$CMRR$ Common-mode rejection ratio	$R_S \leq 200\ \Omega$	80		100 [§]	dB	
I_{CC+} Supply current from V_{CC+} †	$V_{ID} = -5\text{ mV}$, No load	11 [§]		18	mA	
I_{CC-} Supply current from V_{CC-} †		-55°C to 125°C				
P_D Total power dissipation†		-7 [§]		-14	mA	
		180 [§]		300	mW	

† Unless otherwise noted, all characteristics are measured with the strobe open.

‡ The algebraic convention, where the most-positive (least-negative) limit is designated as maximum, is used in this data sheet for logic levels only, e.g., when 0 V is the maximum, the minimum limit is a more-negative voltage.

§ These typical values are at $T_A = 25^\circ\text{C}$.

¶ Supply current and power dissipation limits apply for both comparators operating simultaneously.

NOTE 4: These characteristics are verified by measurements at the following temperatures and output voltage levels: $V_O = 1.8\text{ V}$ at $T_A = -55^\circ\text{C}$, $V_O = 1.4\text{ V}$ at $T_A = 25^\circ\text{C}$, and $V_O = 1\text{ V}$ at $T_A = 125^\circ\text{C}$. These output voltage levels were selected to approximate the logic threshold voltages of the types of digital logic circuits this comparator is intended to drive.

3

Voltage Comparators

TL514M

DUAL DIFFERENTIAL COMPARATOR WITH STROBE

switching characteristics, $V_{CC+} = 12\text{ V}$, $V_{CC-} = -6\text{ V}$, $T_A = 25^\circ\text{C}$

PARAMETER	TEST CONDITIONS	MIN	TYP	MAX	UNIT
Response time	$R_L = \infty$ $C_L = 5\text{ pF}$, See Note 5		30	80	ns
Strobe release time	$R_L = \infty$ $C_L = 5\text{ pF}$, See Note 6		5	25	ns

NOTES: 5. The response time specified is for a 100-mV input step with 5-mV overdrive.

6. For testing purposes, the input bias conditions are selected to produce an output voltage of 1.4 V. A 5-mV overdrive is then added to the input bias voltage to produce an output voltage which rises above 1.4 V. The time interval is measured from the 50% point of the strobe voltage curve to the point where the overdriven output voltage crosses the 1.4-V level.

TYPICAL CHARACTERISTICS

LARGE-SIGNAL DIFFERENTIAL
VOLTAGE AMPLIFICATION
vs
FREE-AIR TEMPERATURE

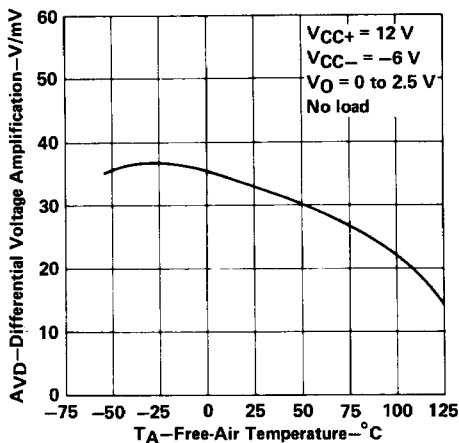

FIGURE 1

LARGE-SIGNAL DIFFERENTIAL
VOLTAGE AMPLIFICATION
vs
SUPPLY VOLTAGE

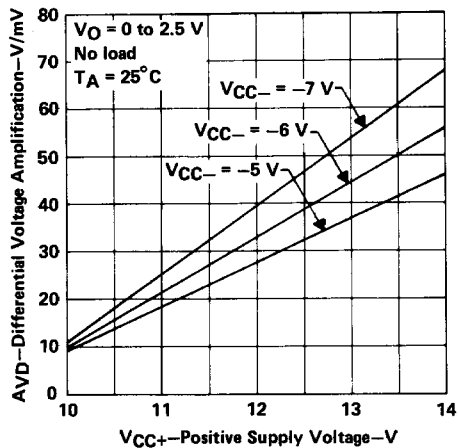

FIGURE 2

Voltage Comparators

TYPICAL CHARACTERISTICS

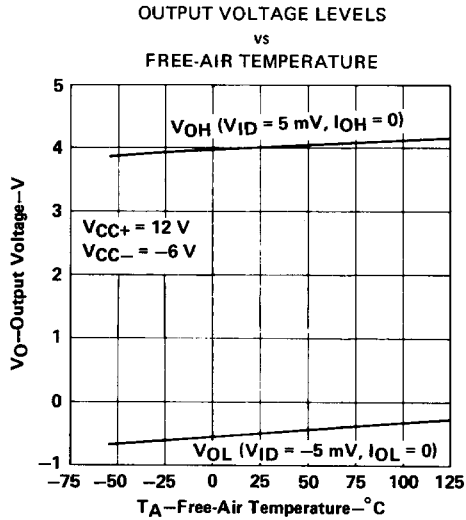

FIGURE 3

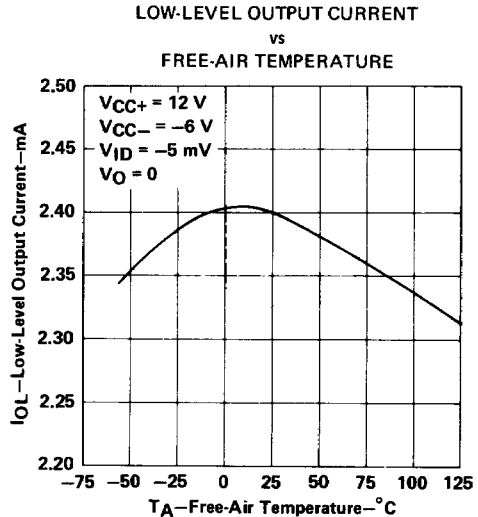

FIGURE 4

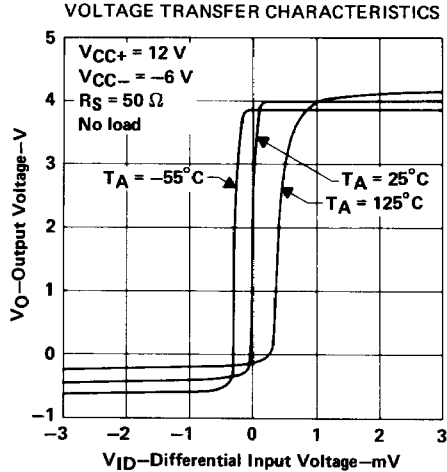

FIGURE 5

3

Voltage Comparators

TL514M DUAL DIFFERENTIAL COMPARATOR WITH STROBE

TYPICAL CHARACTERISTICS

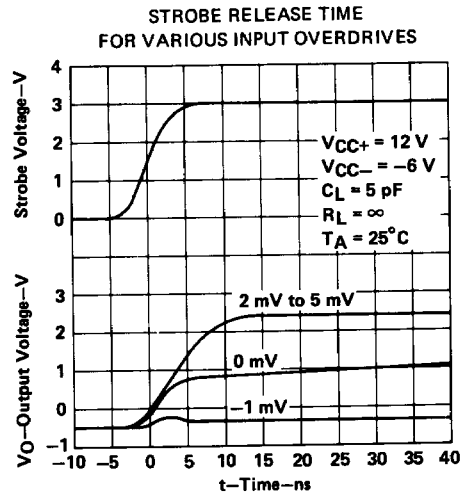
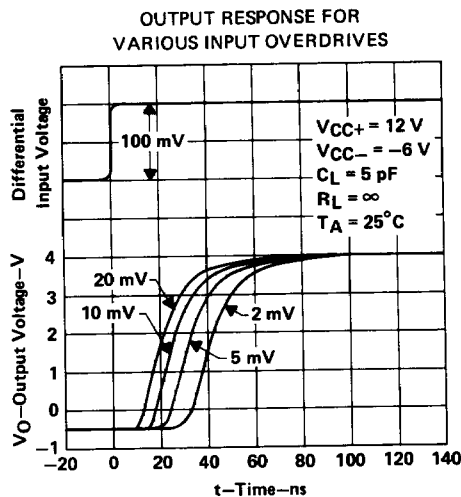
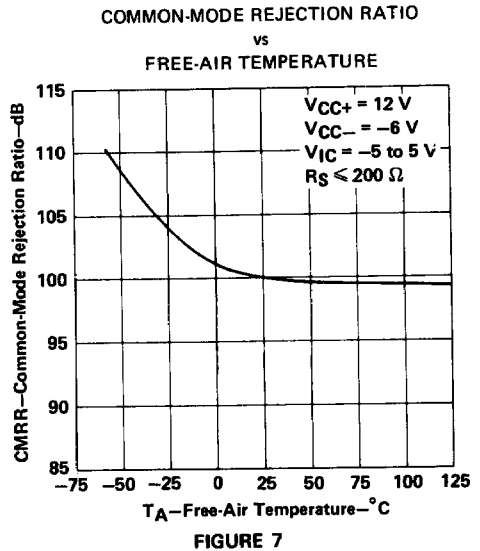
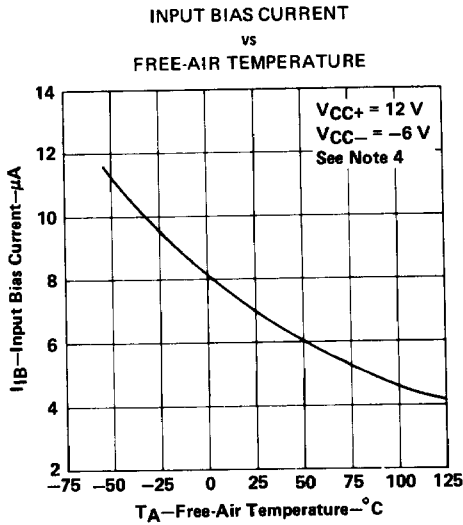

NOTE 4: These characteristics are verified by measurements at the following temperatures and output voltage levels: $V_O = 1.8 \text{ V}$ at $T_A = -55^\circ\text{C}$, $V_O = 1.4 \text{ V}$ at $T_A = 25^\circ\text{C}$, and $V_O = 1 \text{ V}$ at $T_A = 125^\circ\text{C}$. These output voltage levels were selected to approximate the logic threshold voltages of the types of digital logic circuits this comparator is intended to drive.

TYPICAL CHARACTERISTICS

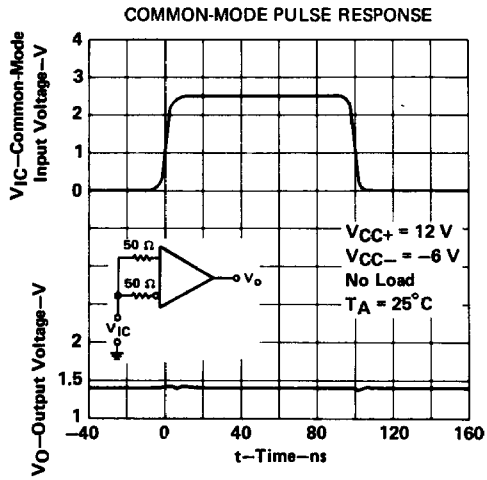

FIGURE 10

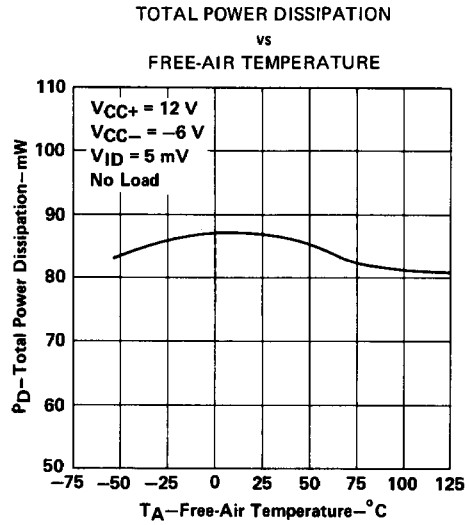

FIGURE 11



Voltage Comparators