

## CMOS LDO Regulators for Portable Equipments

# 1ch 150mA CMOS LDO Regulators

**BH□□PB1WHFV Series**

No.11020EBT05

**●Description**

The BH□□PB1WHFV regulator series can respond to changes in output current by switching to a state in which regulator characteristics are ideal. The regulators cut power consumption by lowering their own current consumption to approximately 2 μA when the application is operating in the standby state. During normal-current operation it will automatically switch to high-speed operating mode. The IC's soft start function reduce the rush current that flows to the output capacitors during startup. The HVSO5 package, which features excellent heat dissipation, contributes to space-saving application designs.

**●Features**

- 1) Automatic switching between low-consumption and high-speed modes
- 2) Built-in rush current prevention circuit
- 3) Low-voltage 1.7 V operation
- 4) High accuracy output voltage: ± 1%
- 5) Circuit current during low-consumption operation: 2 μA
- 6) Stable with a ceramic capacitor (0.47 μF)
- 7) Built-in temperature and overcurrent protection circuits
- 8) Built-in output discharge during standby operation function
- 9) Ultra-small HVSO5 power package

**●Applications**

Battery-driven portable devices, etc.

**●Product lineup**
**■150 mA BH□□PB1WHFV Series**

Product name	1.2	1.5	1.8	2.5	2.8	2.9	3.0	3.1	3.3	Package
BH□□PB1WHFV	√	√	√	√	√	√	√	√	√	HVSO5

 Model name: BH□□PB1W□  
                   a      b

Symbol	Description			
a	Output voltage specification			
	□□	Output voltage (V)	□□	Output voltage (V)
	12	1.2 V (Typ.)	29	2.9 V (Typ.)
	15	1.5 V (Typ.)	30	3.0 V (Typ.)
	18	1.8 V (Typ.)	31	3.1 V (Typ.)
	25	2.5 V (Typ.)	33	3.3 V (Typ.)
	28	2.8 V (Typ.)		
b	Package HFV: HVSO5			

## ● Absolute maximum ratings (Ta = 25°C)

Parameter	Symbol	Ratings	Unit
Power supply voltage	VMAX	-0.3 to +6.5	V
Power dissipation	Pd	410 *1	mW
Operating temperature range	Topr	-40 to +85	°C
Storage temperature range	Tslg	-55 to +125	°C
Junction temperature	Tjmax	125	°C

\*1: Reduced by 4.1 mW/°C over 25°C, when mounted on a glass epoxy board (70 mm × 70 mm × 1.6 mm)

## ● Recommended operating ranges (not to exceed Pd)

Parameter	Symbol	Ratings	Unit
Power supply voltage	VIN	1.7 to 5.5	V
Output MAX current	IMAX	0 to 150	mA

## ● Recommended operating conditions

Parameter	Symbol	Ratings			Unit	Conditions
		Min.	Typ.	Max.		
Input capacitor	CIN	0.33 *2	0.47	-	μF	The use of ceramic capacitors is recommended.
Output capacitor	Co	0.33 *2	0.47	-	μF	The use of ceramic capacitors is recommended.

\*2: Make sure that the output capacitor value is not kept lower than this specified level across a variety of temperature, DC bias characteristic. And also make sure that the capacitor value can not change as time progresses.

## ●Electrical characteristics

(Unless otherwise specified, Ta = 25°C, VIN = VOUT + 1.0 V, STBY = 1.5 V, SEL = 0 V, CIN = 0.47 μF, Co = 0.47 μF)

Parameter	Symbol	Limits			Unit	Conditions	
		Min.	Typ.	Max..			
<b>【Regulator】</b>							
Output voltage (high-speed mode)	VOUT1	VOUT1 ×0.99	-	VOUT1 ×1.01	V	VOUT ≥ 2.5V, IOUT=0.1mA, SEL=1.5V	
		VOUT1 -0.025	-	VOUT1 +0.025	V	VOUT ≤ 1.8V, IOUT=0.1mA, SEL=1.5V	
Output voltage (low-consumption mode)	VOUT2	VOUT2 ×0.97	-	VOUT2 ×1.038	V	VOUT ≥ 2.5V, IOUT=0.1mA, SEL=0V	
		VOUT2 ×0.967	-	VOUT2 ×1.043	V	VOUT ≤ 1.8V, IOUT=0.1mA, SEL=0V	
Circuit current (high-speed mode)	ICC1	-	20	40	μA	IOUT=0mA, VIN pin monitor, SEL=1.5V	
Circuit current (low-consumption mode)	ICC2	-	2	4	μA	IOUT=0mA, VIN pin monitor, SEL=0V	
Circuit current (STBY)	ISTBY	-	-	1.0	μA	STBY=0V	
Ripple rejection ratio (high-speed mode)	RR1	42	60	-	dB	VRR=-20dBv, fRR=1kHz, IOUT=10mA, SEL=1.5V	
Dropout voltage 1 *1	VSAT1	-	100	200	mV	VIN=VOUT×0.98, IOUT=50mA	
Dropout voltage 2 *1	VSAT2	-	210	400	mV	VIN=VOUT×0.98, IOUT=100mA	
Dropout voltage 3 *1	VSAT3	-	315	600	mV	VIN=VOUT×0.98, IOUT=150mA	
Line regulation 1 (high-speed mode)	VDL1	-	2	20	mV	VIN=VOUT+1V to 5.5V, IOUT=10mA	
Line regulation 2 (low-consumption mode)	VDL2	-	2	20	mV	VIN=VOUT+1V to 5.5V, IOUT=100μA	
Load regulation	VDLO	-	10	40	mV	IOUT=10mA to 100mA	
<b>【Mode switch】</b>							
Current threshold (low-consumption mode)	ITH1	0.09	0.3	-	mA	SEL=0V IOUT=3mA⇒0mA sweep	
Current threshold (high-speed mode)	ITH2	-	1.2	2.2	mA	SEL=0V IOUT=0mA⇒3mA sweep	
<b>【Over Current Protection 1】</b>							
Limit Current	ILMAX	160	300	500	mA	Vo=VOUT×0.90	
Short current	ISHORT	20	50	100	mA	Vo=0V	
<b>【Stand-by block】</b>							
STBY pin sink current	ISTB	-	2	4	μA	STBY=1.5V	
STBY control voltage	ON	VSTBH	1.5	-	VIN	V	
	OFF	VSTBL	-0.3	-	0.3	V	
Discharge resistance at standby	RDCG	1.5	2.2	3.0	kΩ	STBY=0V	
<b>【SEL PIN】</b>							
Pull-down resistance of SEL pin	RSEL	0.5	1.0	2.0	MΩ		
SEL control voltage	ON	VSELH	1.5	-	VIN	V	Fixed high speed mode
	OFF	VSELL	-0.3	-	0.3	V	Automatic switch mode

\* Note: This IC is not designed to be radiation-resistant. \*3: Except at VOUT ≤ 1.5 V.

## ●Electrical characteristics of each output voltage

Output Voltage	Parameter	Min.	Typ.	Max.	Unit	Conditions
1.2 V	Max. output current	70	120	-	mA	VCC = 1.7 V
		150	-	-		VCC = 2.0 V
1.5 V		50	100	-		VCC = 1.8 V
		150	-	-		VCC = 2.2 V
1.8 V ≤ VOUT		75	143	-		VCC = VOUT + 0.3 V
		150	-	-		VCC = VOUT + 0.6 V

● Typical characteristics

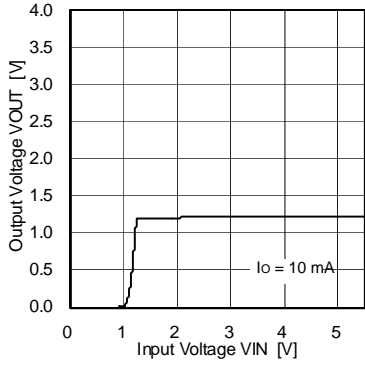

Fig.1 Output Voltage vs Input Voltage (BH12PB1WHFV)

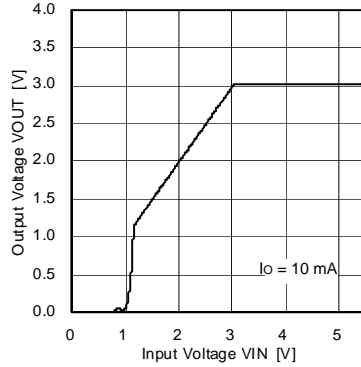

Fig.2 Output Voltage vs Input Voltage (BH30PB1WHFV)

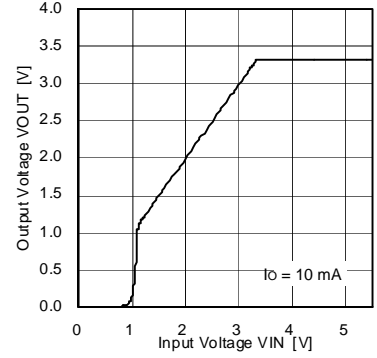
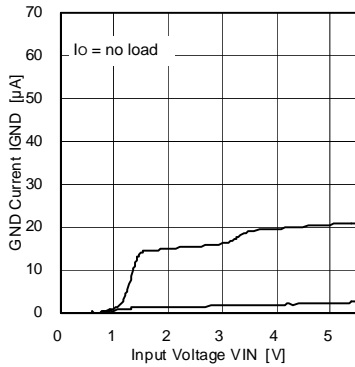
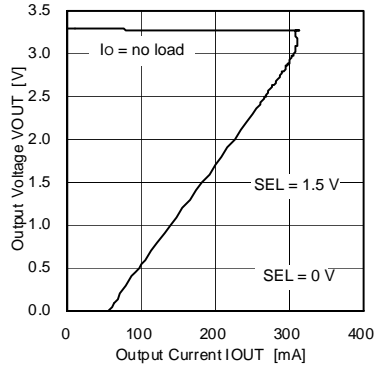

Fig.3 Output Voltage vs Input Voltage (BH33PB1WHFV)



(BH30PB1WHFV)  
(BH12PB1WHFV)



(BH30PB1WHFV)

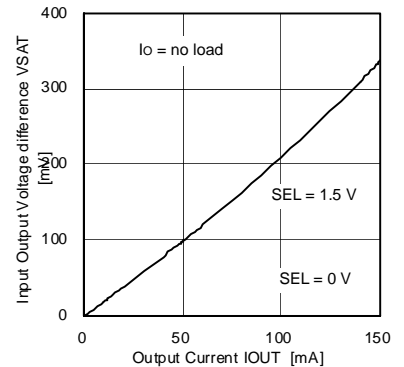
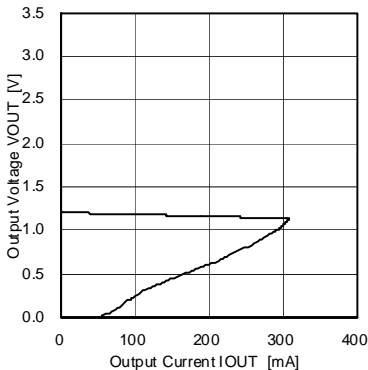

Fig.6 GND Current vs Input Voltage (BH33PB1WHFV)



(BH30PB1WHFV)  
(BH12PB1WHFV)

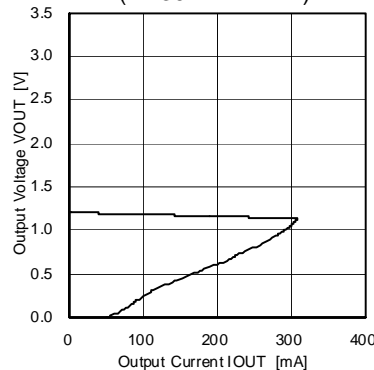

Fig.8 Output Voltage vs Output Current (BH30PB1WHFV)

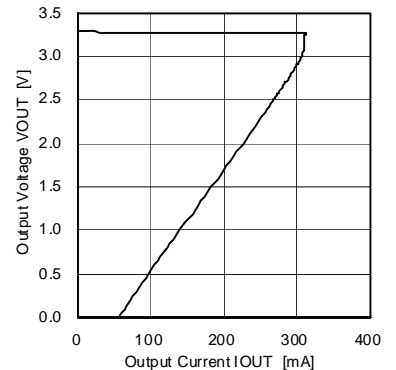

Fig.9 Output Voltage vs Output Current (BH33PB1WHFV)

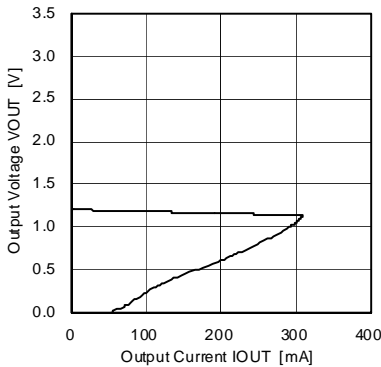

Fig.10 Dropout voltage vs Output Current (BH18PB1WHFV)

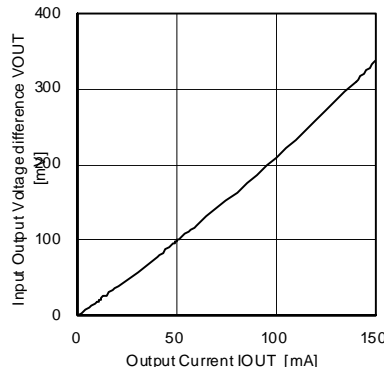

Fig.11 Dropout voltage vs Output Current (BH30PB1WHFV)

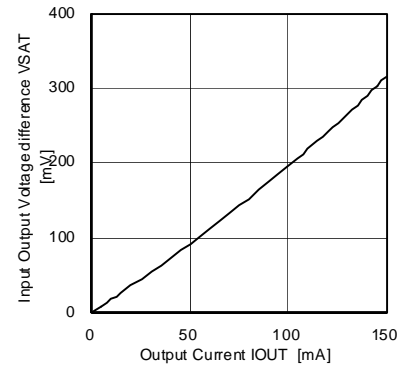

Fig.12 Dropout voltage vs Output Current (BH33PB1WHFV)

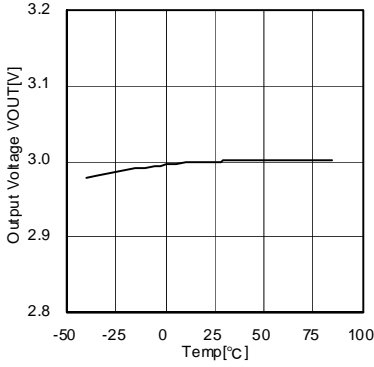

Fig.13 Output Voltage vs Temperature (BH30PB1WHFV)

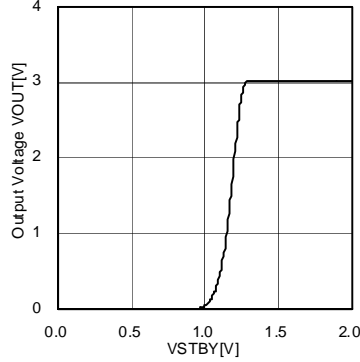

Fig.14 Standby Pin Threshold (BH30PB1WHFV)

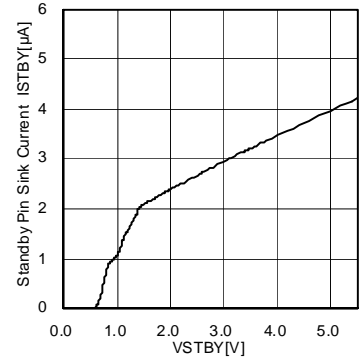

Fig.15 Standby Pin Sink Current (BH30PB1WHFV)

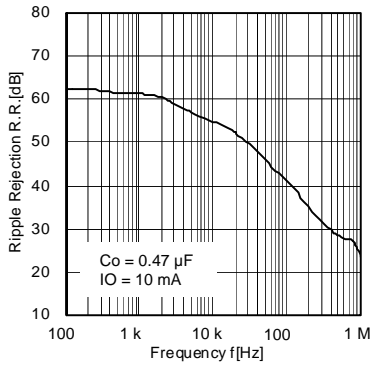

Fig.16 Ripple Rejection (BH12PB1WHFV)

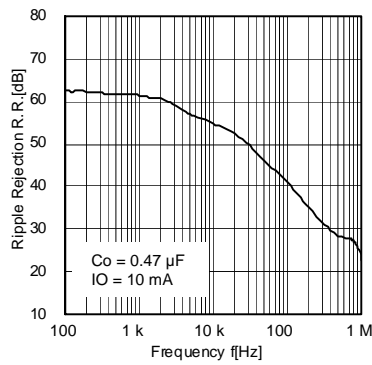

Fig.17 Ripple Rejection (BH30PB1WHFV)

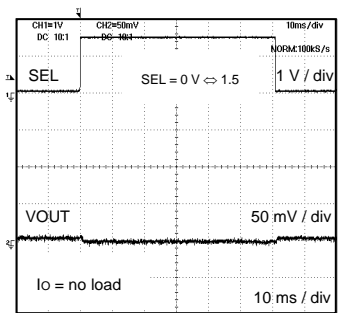

Fig.18 Output Voltage Waveform During SEL Switching (BH30PB1WHFV)

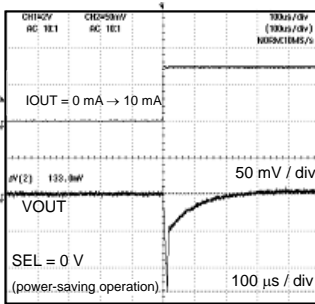

Fig.19 Load Response (Co = 1.0 μF) (BH30PB1WHFV)

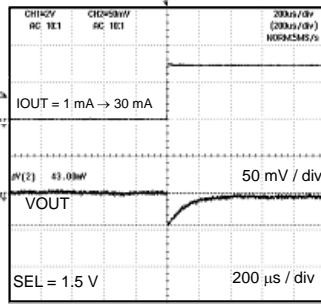

Fig.20 Load Response (Co=1.0 μF) (BH30PB1WHFV)

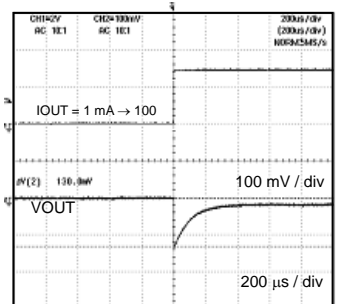

Fig.21 Load Response (Co=1.0 μF) (BH30PB1WHFV)

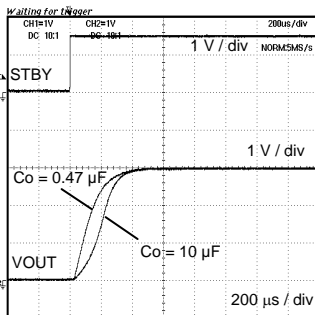

Fig.22 Output Voltage Rise Time (BH30PB1WHFV)

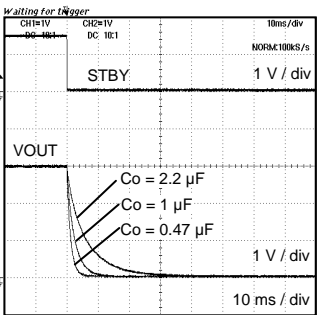

Fig.23 Output Voltage Fall Time (BH30PB1WHFV)

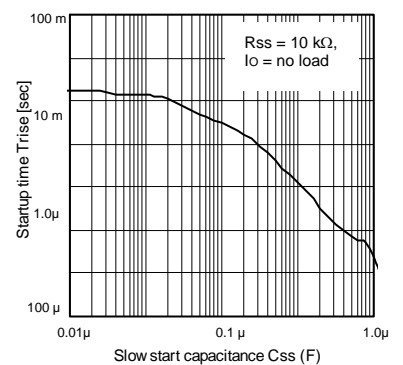
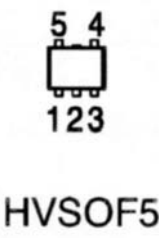

Fig.24 Soft Start Rise Time (BH30PB1WHFV)

●Block diagram, recommended circuit diagram, and pin assignment table

BH□□PB1WHFV



HVSOF5

PIN No.	Symbol	Function
1	STBY	Output voltage on/off control(High: ON, Low: OFF)
2	GND	Ground
3	VIN	Power supply input
4	VOUT	Voltage output
5	SEL	Mode switching (High: Fix in high-speed mode Low: Automatic low-consumption mode switching)

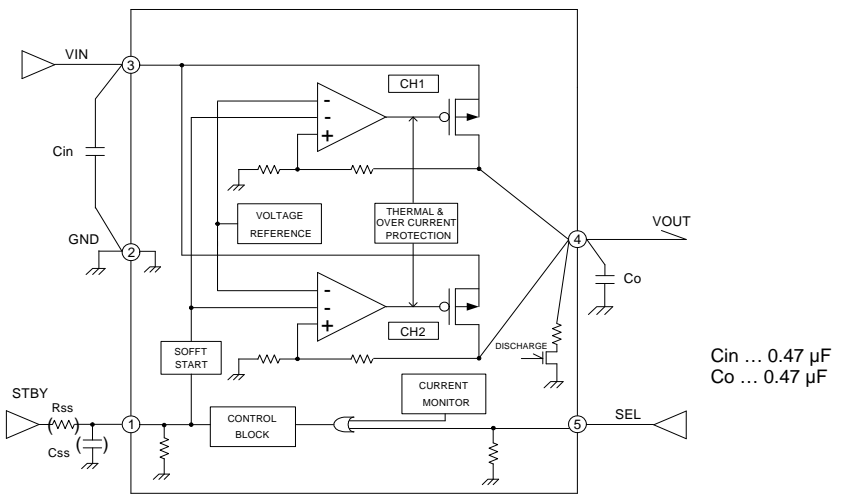

Fig.25

●Auto Power-saving Function

The IC incorporates a built-in auto power-saving function that continuously monitors the output current and switches automatically between a low current consumption regulator and a high-speed operation regulator. This function reduces the regulator's own current consumption to approximately 1/10 or lower of normal levels when the output current falls below approximately 300 μA. To operate only the high-speed function, fix the SEL pin to high.

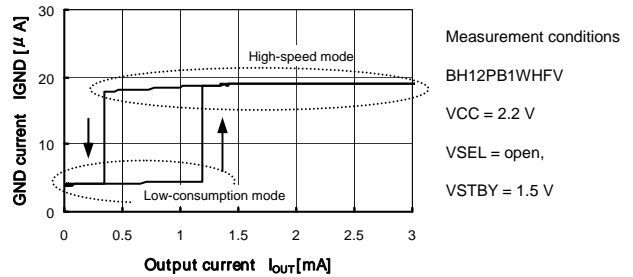

Fig.26 Auto Power-Saving Function (Example)

●Power Dissipation (Pd)

1. Power Dissipation (Pd)

Power dissipation calculations include estimates of power dissipation characteristics and internal IC power consumption, and should be treated as guidelines. In the event that the IC is used in an environment where this power dissipation is exceeded, the attendant rise in the junction temperature will trigger the thermal shutdown circuit, reducing the current capacity and otherwise degrading the IC's design performance. Allow for sufficient margins so that this power dissipation is not exceeded during IC operation.

Calculating the maximum internal IC power consumption (P<sub>MAX</sub>)

$$P_{MAX} = (V_{IN} - V_{OUT}) \times I_{OUT} (MAX.)$$

}

V<sub>IN</sub> : Input voltage  
V<sub>OUT</sub> : Output voltage  
I<sub>OUT</sub> (MAX) : Max. output current

2. Power Dissipation/Heat Reduction (Pd)

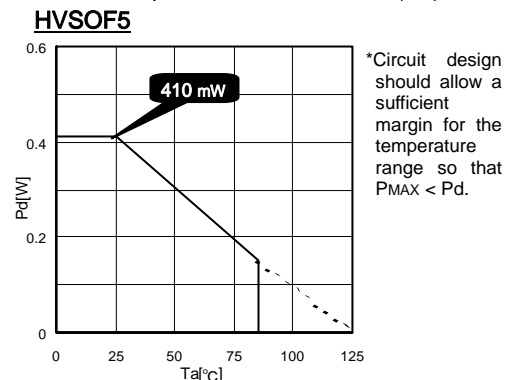

Fig.27 HVSOF5 Power Dissipation vs Heat Reduction (Example)

● **Input Output capacitors**

It is recommended to insert bypass capacitors between input and GND pins, positioning them as close to the pins as possible. These capacitors will be used when the power supply impedance increases or when long wiring paths are used, so they should be checked once the IC has been mounted. Ceramic capacitors generally have temperature and DC bias characteristics. When selecting ceramic capacitors, use X5R or X7R, or better models that offer good temperature and DC bias characteristics and high tolerant voltages.

Typical ceramic capacitor characteristics

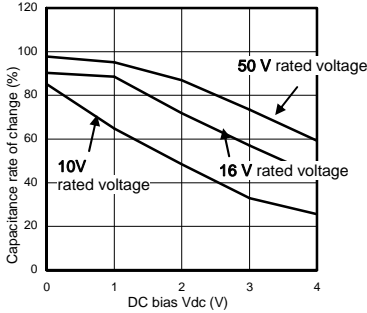

Fig.28 Capacitance vs Bias (Y5V)

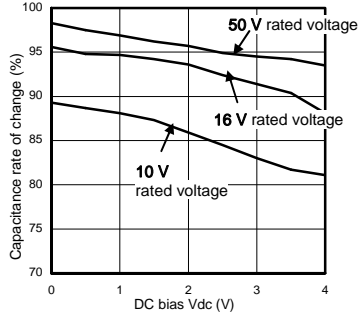

Fig.29 Capacitance vs Bias (X5R, X7R)

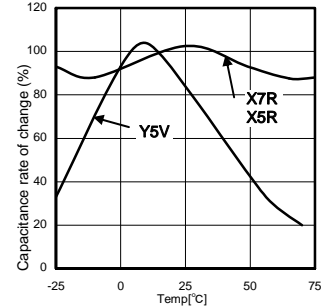

Fig.30 Capacitance vs Temperature (X5R, X7R, Y5V)

● **Output capacitors**

Mounting input capacitor between input pin and GND(as close to pin as possible), and also output capacitor between output pin and GND(as close to pin as possible) is recommended. The input capacitor reduces the output impedance of the voltage supply source connected to the VCC. The higher value the output capacitor goes the more stable the whole operation becomes. This leads to high load transient response. Please confirm the whole operation on actual application board. Generally, ceramic capacitor has wide range of tolerance, temperature coefficient, and DC bias characteristic. And also its value goes lower as time progresses. Please choose ceramic capacitors after obtaining more detailed data by asking capacitor makers.

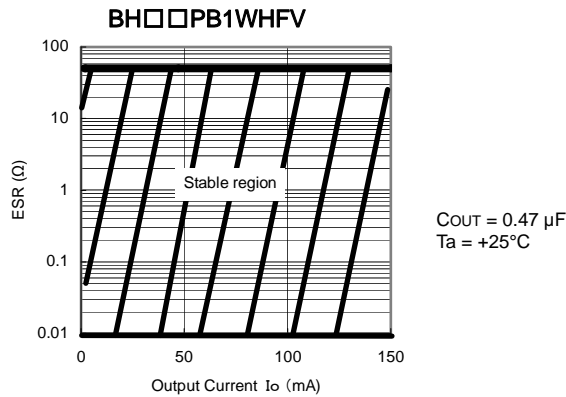

Fig.31 Stable Operation Region (Example)

### ●Notes for use

1. Absolute maximum ratings  
An excess in the absolute maximum ratings, such as supply voltage, temperature range of operating conditions, etc., can break down the devices, thus making impossible to identify breaking mode, such as a short circuit or an open circuit. If any over rated values will expect to exceed the absolute maximum ratings, consider adding circuit protection devices, such as fuses.
2. Thermal design  
Use a thermal design that allows for a sufficient margin in light of the power dissipation (Pd) in actual operating conditions.
3. Inter-pin shorts and mounting errors  
Use caution when positioning the IC for mounting on printed circuit boards. The IC may be damaged if there is any connection error or if pins are shorted together.
4. Thermal shutdown circuit (TSD)  
The IC incorporates a built-in thermal shutdown circuit (TSD circuit). The thermal shutdown circuit is designed only to shut the IC off to prevent runaway thermal operation. It is not designed to protect the IC or guarantee its operation. Do not continue to use the IC after operating this circuit or use the IC in an environment where the operation of this circuit is assumed.
5. Ground wiring patterns  
The power supply and ground lines must be as short and thick as possible to reduce line impedance. Fluctuating voltage on the power ground line may damage the device.
6. Overcurrent protection circuit  
The IC incorporates a built-in overcurrent protection circuit that operates according to the output current capacity. This circuit serves to protect the IC from damage when the load is shorted. The protection circuit is designed to limit current flow by not latching in the event of a large and instantaneous current flow originating from a large capacitor or other component. These protection circuits are effective in preventing damage due to sudden and unexpected accidents. However, the IC should not be used in applications characterized by the continuous operation or transitioning of the protection circuits. At the time of thermal designing, keep in mind that the current capability has negative characteristics to temperatures.
7. Actions in strong electromagnetic field  
Use caution when using the IC in the presence of a strong electromagnetic field as doing so may cause the IC to malfunction.
8. Back current  
In applications where the IC may be exposed to back current flow, it is recommended to create a path to dissipate this current by inserting a bypass diode between the VIN and VOUT pins.

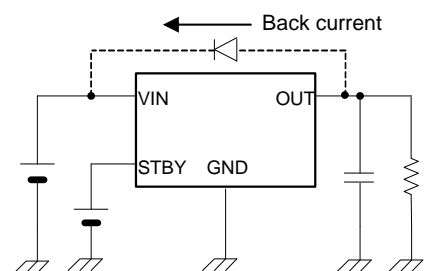

Fig.32 Example Bypass Diode Connection

9. I/O voltage difference  
Using the IC in automatic switching mode when the I/O voltage differential becomes saturated ( $V_{IN} - V_{OUT} < 150 \text{ mV}$ ) may result in a large output noise level. If the noise level becomes problematic, use the IC with the SEL pin in the high state when the voltage differential is saturated.
10. GND Voltage  
The potential of GND pin must be minimum potential in all operating conditions.



11. Preventing Rush Current

By attaching the  $R_{ss}$  and  $C_{ss}$  time constants to the STBY pin, sudden rises in the regulator output voltage can be prevented, dampening the flow of rush current to the output capacitors. The larger the time constant used, the greater the resulting reduction. However, large time constants also result in longer startup times, so the constant should be selected after considering the conditions in which the IC is to be used.

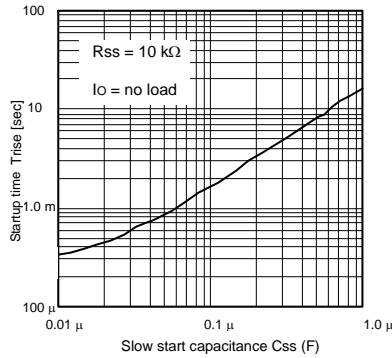

Fig.33 VOUT Startup Time vs CSS Capacitance (Reference)

12. Regarding input Pin of the IC (Fig.34)

This monolithic IC contains P+ isolation and P substrate layers between adjacent elements in order to keep them isolated. P-N junctions are formed at the intersection of these P layers with the N layers of other elements, creating a parasitic diode or transistor. For example, the relation between each potential is as follows:

When  $GND > Pin\ A$  and  $GND > Pin\ B$ , the P-N junction operates as a parasitic diode.

When  $GND > Pin\ B$ , the P-N junction operates as a parasitic transistor.

Parasitic diodes can occur inevitable in the structure of the IC. The operation of parasitic diodes can result in mutual interference among circuits, operational faults, or physical damage. Accordingly, methods by which parasitic diodes operate, such as applying a voltage that is lower than the GND (P substrate) voltage to an input pin, should not be used.

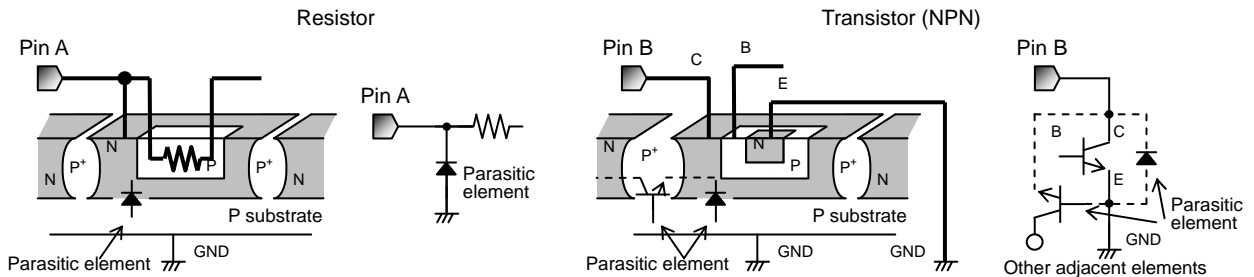
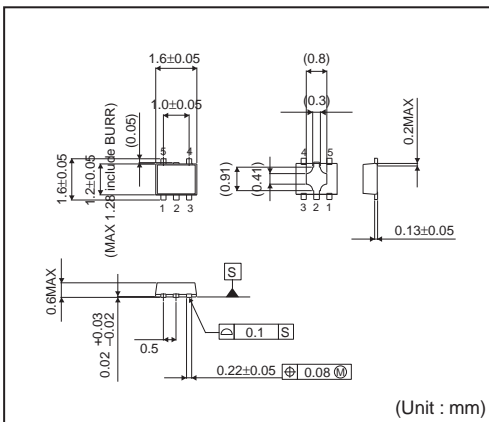

Fig.34

●Ordering part number

B	H	3	0	P	B	1	W	H	F	V	-	T	R
Part No.		Output voltage 12: 1.2 V 15: 1.5 V 18: 1.8 V 25: 2.5 V 28: 2.8 V 29: 2.9 V 30: 3.0 V 31: 3.1 V 33: 3.3 V		Series PB1:Auto power-saving type			Shutdown switch W : Includes switch	Package HFV : HVSO5F5	Packaging and forming specification TR: Embossed tape and reel				

HVSO5F5



<Tape and Reel information>

Tape	Embossed carrier tape
Quantity	3000pcs
Direction of feed	TR (The direction is the 1pin of product is at the upper right when you hold reel on the left hand and you pull out the tape on the right hand)

\*Order quantity needs to be multiple of the minimum quantity.

# Notice

## Precaution on using ROHM Products

- Our Products are designed and manufactured for application in ordinary electronic equipments (such as AV equipment, OA equipment, telecommunication equipment, home electronic appliances, amusement equipment, etc.). If you intend to use our Products in devices requiring extremely high reliability (such as medical equipment <sup>(Note 1)</sup>, transport equipment, traffic equipment, aircraft/spacecraft, nuclear power controllers, fuel controllers, car equipment including car accessories, safety devices, etc.) and whose malfunction or failure may cause loss of human life, bodily injury or serious damage to property ("Specific Applications"), please consult with the ROHM sales representative in advance. Unless otherwise agreed in writing by ROHM in advance, ROHM shall not be in any way responsible or liable for any damages, expenses or losses incurred by you or third parties arising from the use of any ROHM's Products for Specific Applications.

(Note1) Medical Equipment Classification of the Specific Applications

JAPAN	USA	EU	CHINA
CLASS III	CLASS III	CLASS II b	CLASS III
CLASS IV		CLASS III	

- ROHM designs and manufactures its Products subject to strict quality control system. However, semiconductor products can fail or malfunction at a certain rate. Please be sure to implement, at your own responsibilities, adequate safety measures including but not limited to fail-safe design against the physical injury, damage to any property, which a failure or malfunction of our Products may cause. The following are examples of safety measures:
  - Installation of protection circuits or other protective devices to improve system safety
  - Installation of redundant circuits to reduce the impact of single or multiple circuit failure
- Our Products are designed and manufactured for use under standard conditions and not under any special or extraordinary environments or conditions, as exemplified below. Accordingly, ROHM shall not be in any way responsible or liable for any damages, expenses or losses arising from the use of any ROHM's Products under any special or extraordinary environments or conditions. If you intend to use our Products under any special or extraordinary environments or conditions (as exemplified below), your independent verification and confirmation of product performance, reliability, etc. prior to use, must be necessary:
  - Use of our Products in any types of liquid, including water, oils, chemicals, and organic solvents
  - Use of our Products outdoors or in places where the Products are exposed to direct sunlight or dust
  - Use of our Products in places where the Products are exposed to sea wind or corrosive gases, including Cl<sub>2</sub>, H<sub>2</sub>S, NH<sub>3</sub>, SO<sub>2</sub>, and NO<sub>2</sub>
  - Use of our Products in places where the Products are exposed to static electricity or electromagnetic waves
  - Use of our Products in proximity to heat-producing components, plastic cords, or other flammable items
  - Sealing or coating our Products with resin or other coating materials
  - Use of our Products without cleaning residue of flux (even if you use no-clean type fluxes, cleaning residue of flux is recommended); or Washing our Products by using water or water-soluble cleaning agents for cleaning residue after soldering
  - Use of the Products in places subject to dew condensation
- The Products are not subject to radiation-proof design.
- Please verify and confirm characteristics of the final or mounted products in using the Products.
- In particular, if a transient load (a large amount of load applied in a short period of time, such as pulse. is applied, confirmation of performance characteristics after on-board mounting is strongly recommended. Avoid applying power exceeding normal rated power; exceeding the power rating under steady-state loading condition may negatively affect product performance and reliability.
- De-rate Power Dissipation (Pd) depending on Ambient temperature (Ta). When used in sealed area, confirm the actual ambient temperature.
- Confirm that operation temperature is within the specified range described in the product specification.
- ROHM shall not be in any way responsible or liable for failure induced under deviant condition from what is defined in this document.

## Precaution for Mounting / Circuit board design

- When a highly active halogenous (chlorine, bromine, etc.) flux is used, the residue of flux may negatively affect product performance and reliability.
- In principle, the reflow soldering method must be used; if flow soldering method is preferred, please consult with the ROHM representative in advance.

For details, please refer to ROHM Mounting specification

**Precautions Regarding Application Examples and External Circuits**

1. If change is made to the constant of an external circuit, please allow a sufficient margin considering variations of the characteristics of the Products and external components, including transient characteristics, as well as static characteristics.
2. You agree that application notes, reference designs, and associated data and information contained in this document are presented only as guidance for Products use. Therefore, in case you use such information, you are solely responsible for it and you must exercise your own independent verification and judgment in the use of such information contained in this document. ROHM shall not be in any way responsible or liable for any damages, expenses or losses incurred by you or third parties arising from the use of such information.

**Precaution for Electrostatic**

This Product is electrostatic sensitive product, which may be damaged due to electrostatic discharge. Please take proper caution in your manufacturing process and storage so that voltage exceeding the Products maximum rating will not be applied to Products. Please take special care under dry condition (e.g. Grounding of human body / equipment / solder iron, isolation from charged objects, setting of Ionizer, friction prevention and temperature / humidity control).

**Precaution for Storage / Transportation**

1. Product performance and soldered connections may deteriorate if the Products are stored in the places where:
  - [a] the Products are exposed to sea winds or corrosive gases, including Cl<sub>2</sub>, H<sub>2</sub>S, NH<sub>3</sub>, SO<sub>2</sub>, and NO<sub>2</sub>
  - [b] the temperature or humidity exceeds those recommended by ROHM
  - [c] the Products are exposed to direct sunshine or condensation
  - [d] the Products are exposed to high Electrostatic
2. Even under ROHM recommended storage condition, solderability of products out of recommended storage time period may be degraded. It is strongly recommended to confirm solderability before using Products of which storage time is exceeding the recommended storage time period.
3. Store / transport cartons in the correct direction, which is indicated on a carton with a symbol. Otherwise bent leads may occur due to excessive stress applied when dropping of a carton.
4. Use Products within the specified time after opening a humidity barrier bag. Baking is required before using Products of which storage time is exceeding the recommended storage time period.

**Precaution for Product Label**

QR code printed on ROHM Products label is for ROHM's internal use only.

**Precaution for Disposition**

When disposing Products please dispose them properly using an authorized industry waste company.

**Precaution for Foreign Exchange and Foreign Trade act**

Since our Products might fall under controlled goods prescribed by the applicable foreign exchange and foreign trade act, please consult with ROHM representative in case of export.

**Precaution Regarding Intellectual Property Rights**

1. All information and data including but not limited to application example contained in this document is for reference only. ROHM does not warrant that foregoing information or data will not infringe any intellectual property rights or any other rights of any third party regarding such information or data. ROHM shall not be in any way responsible or liable for infringement of any intellectual property rights or other damages arising from use of such information or data.:
2. No license, expressly or implied, is granted hereby under any intellectual property rights or other rights of ROHM or any third parties with respect to the information contained in this document.

**Other Precaution**

1. This document may not be reprinted or reproduced, in whole or in part, without prior written consent of ROHM.
2. The Products may not be disassembled, converted, modified, reproduced or otherwise changed without prior written consent of ROHM.
3. In no event shall you use in any way whatsoever the Products and the related technical information contained in the Products or this document for any military purposes, including but not limited to, the development of mass-destruction weapons.
4. The proper names of companies or products described in this document are trademarks or registered trademarks of ROHM, its affiliated companies or third parties.

**General Precaution**

1. Before you use our Products, you are requested to carefully read this document and fully understand its contents. ROHM shall not be in any way responsible or liable for failure, malfunction or accident arising from the use of any ROHM's Products against warning, caution or note contained in this document.
2. All information contained in this document is current as of the issuing date and subject to change without any prior notice. Before purchasing or using ROHM's Products, please confirm the latest information with a ROHM sales representative.
3. The information contained in this document is provided on an "as is" basis and ROHM does not warrant that all information contained in this document is accurate and/or error-free. ROHM shall not be in any way responsible or liable for any damages, expenses or losses incurred by you or third parties resulting from inaccuracy or errors of or concerning such information.



BH30PB1WHFV - Web Page

[Distribution Inventory](#)

Part Number	BH30PB1WHFV
Package	HVSOF5
Unit Quantity	3000
Minimum Package Quantity	3000
Packing Type	Taping
Constitution Materials List	inquiry
RoHS	Yes