

| | |
|---------------------|-------|
| V_{DSS} | -30V |
| $R_{DS(on)}$ (Max.) | 75mΩ |
| I_D | -3A |
| P_D | 1.25W |

●Features

- 1) Low on - resistance.
- 2) Built-in G-S Protection Diode.
- 3) Small Surface Mount Package (TSMT6).
- 4) Pb-free lead plating ; RoHS compliant

●Application

DC/DC converters

●Outline

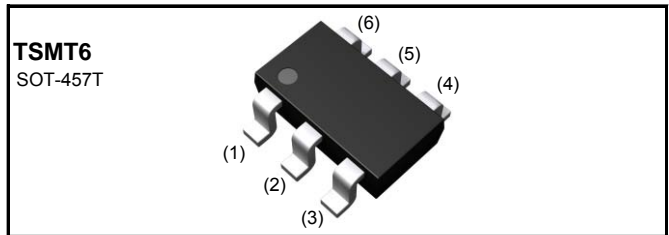

●Inner circuit

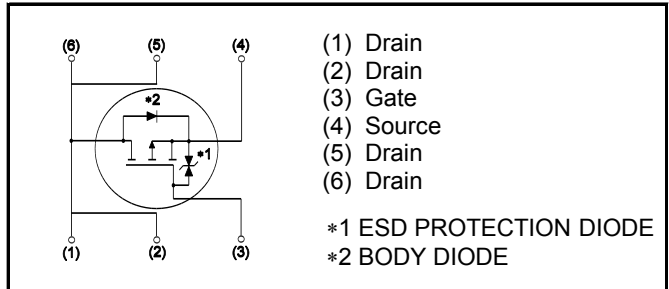

●Packaging specifications

| Type | Packaging | Taping |
|------|---------------------------|--------|
| | Reel size (mm) | 180 |
| | Tape width (mm) | 8 |
| | Basic ordering unit (pcs) | 3,000 |
| | Taping code | TR |
| | Marking | UA |

●Absolute maximum ratings($T_a = 25^\circ\text{C}$)

| Parameter | Symbol | Value | Unit |
|------------------------------|--------------------|-------------|------|
| Drain - Source voltage | V_{DSS} | -30 | V |
| Continuous drain current | I_D^{*1} | ±3 | A |
| Pulsed drain current | $I_{D,pulse}^{*2}$ | ±12 | A |
| Gate - Source voltage | V_{GSS} | ±20 | V |
| Power dissipation | P_D^{*3} | 1.25 | W |
| | P_D^{*4} | 0.6 | W |
| Junction temperature | T_j | 150 | °C |
| Range of storage temperature | T_{stg} | -55 to +150 | °C |

●Thermal resistance

| Parameter | Symbol | Values | | | Unit |
|--|-----------------|--------|------|------|------|
| | | Min. | Typ. | Max. | |
| Thermal resistance, junction - ambient | R_{thJA}^{*3} | - | - | 100 | °C/W |
| | R_{thJA}^{*4} | - | - | 208 | °C/W |

●Electrical characteristics($T_a = 25^\circ\text{C}$)

<It is the same characteristics for the Tr1 and Tr2>

| Parameter | Symbol | Conditions | Values | | | Unit |
|--|---|---|--------|------|------|-------|
| | | | Min. | Typ. | Max. | |
| Drain - Source breakdown voltage | $V_{(BR)DSS}$ | $V_{GS} = 0V, I_D = -1mA$ | -30 | - | - | V |
| Breakdown voltage temperature coefficient | $\frac{\Delta V_{(BR)DSS}}{\Delta T_j}$ | $I_D = -1mA$ referenced to 25°C | - | -25 | - | mV/°C |
| Zero gate voltage drain current | I_{DSS} | $V_{DS} = -30V, V_{GS} = 0V$ | - | - | -1 | μA |
| Gate - Source leakage current | I_{GSS} | $V_{GS} = \pm 20V, V_{DS} = 0V$ | - | - | ±10 | μA |
| Gate threshold voltage | $V_{GS(th)}$ | $V_{DS} = -10V, I_D = -1mA$ | -1.0 | - | -2.5 | V |
| Gate threshold voltage temperature coefficient | $\frac{\Delta V_{(GS)th}}{\Delta T_j}$ | $I_D = -1mA$ referenced to 25°C | - | 3.9 | - | mV/°C |
| Static drain - source on - state resistance | $R_{DS(on)}^{*5}$ | $V_{GS} = -10V, I_D = -3A$ | - | 55 | 75 | mΩ |
| | | $V_{GS} = -4.5V, I_D = -1.5A$ | - | 85 | 115 | |
| | | $V_{GS} = -4.0V, I_D = -1.5A$ | - | 95 | 125 | |
| | | $V_{GS} = -10V, I_D = -3A, T_j = 125^\circ\text{C}$ | - | 95 | 125 | |
| Gate input resistance | R_G | $f = 1MHz, \text{open drain}$ | - | 24 | - | Ω |
| Transconductance | g_{fs}^{*5} | $V_{DS} = -10V, I_D = -3A$ | 2.4 | 5.0 | - | S |

*1 Limited only by maximum temperature allowed.

*2 $P_w \leq 10\mu\text{s}$, Duty cycle $\leq 1\%$

*3 Mounted on a ceramic board (30×30×0.8mm)

*4 Mounted on a FR4 (15×20×0.8mm)

*5 Pulsed

●Electrical characteristics($T_a = 25^\circ\text{C}$)

<It is the same characteristics for the Tr1 and Tr2>

| Parameter | Symbol | Conditions | Values | | | Unit |
|------------------------------|-------------------|--------------------------------------|--------|------|------|------|
| | | | Min. | Typ. | Max. | |
| Input capacitance | C_{iss} | $V_{GS} = 0V$ | - | 480 | - | pF |
| Output capacitance | C_{oss} | $V_{DS} = -10V$ | - | 70 | - | |
| Reverse transfer capacitance | C_{rss} | $f = 1\text{MHz}$ | - | 70 | - | |
| Turn - on delay time | $t_{d(on)}^{*5}$ | $V_{DD} \approx -15V, V_{GS} = -10V$ | - | 7 | - | ns |
| Rise time | t_r^{*5} | $I_D = -1.5A$ | - | 18 | - | |
| Turn - off delay time | $t_{d(off)}^{*5}$ | $R_L = 10\Omega$ | - | 50 | - | |
| Fall time | t_f^{*5} | $R_G = 10\Omega$ | - | 35 | - | |

●Gate Charge characteristics($T_a = 25^\circ\text{C}$)

<It is the same characteristics for the Tr1 and Tr2>

| Parameter | Symbol | Conditions | Values | | | Unit |
|----------------------|---------------|---|--------|------|------|------|
| | | | Min. | Typ. | Max. | |
| Total gate charge | Q_g^{*5} | $V_{DD} \approx -15V, I_D = -3A$ $V_{GS} = -5V$ | - | 5.2 | - | nC |
| | | $V_{DD} \approx -15V, I_D = -3A$ $V_{GS} = -10V$ | - | 12 | - | |
| Gate - Source charge | Q_{gs}^{*5} | $V_{DD} \approx -15V, I_D = -3A$ | - | 1.6 | - | |
| Gate - Drain charge | Q_{gd}^{*5} | $V_{GS} = -5V$ | - | 1.6 | - | |

●Body diode electrical characteristics (Source-Drain)($T_a = 25^\circ\text{C}$)

<It is the same characteristics for the Tr1 and Tr2>

| Parameter | Symbol | Conditions | Values | | | Unit |
|---|---------------|--------------------------|--------|------|------|------|
| | | | Min. | Typ. | Max. | |
| Inverse diode continuous, forward current | I_S^{*1} | $T_a = 25^\circ\text{C}$ | - | - | -1.0 | A |
| Forward voltage | V_{SD}^{*5} | $V_{GS} = 0V, I_S = -3A$ | - | - | -1.2 | V |

●Electrical characteristic curves

Fig.1 Power Dissipation Derating Curve

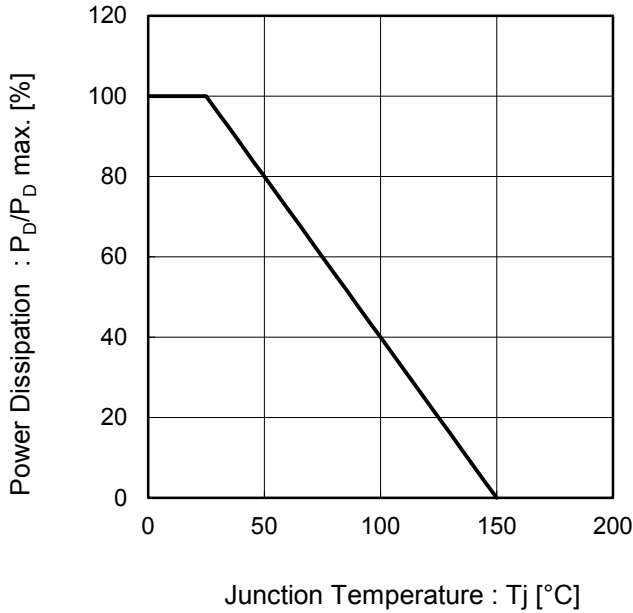

Fig.2 Maximum Safe Operating Area

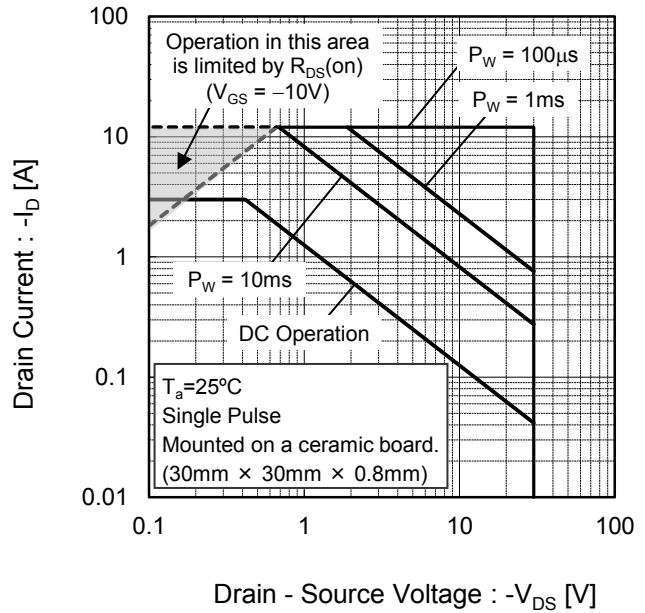

Fig.3 Normalized Transient Thermal Resistance vs. Pulse Width

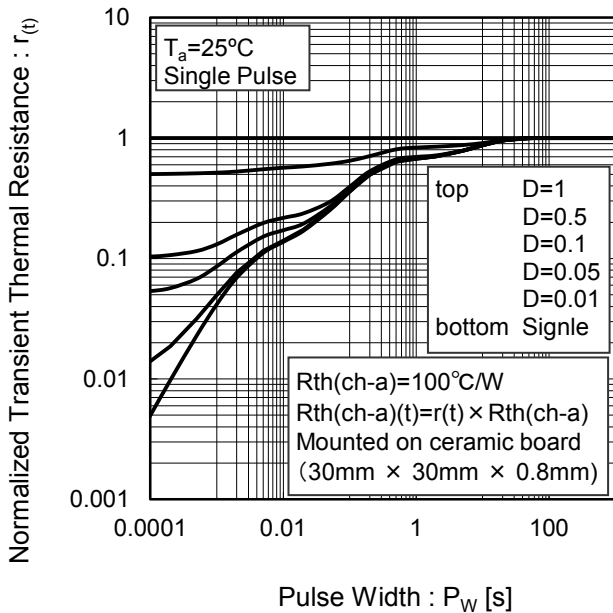
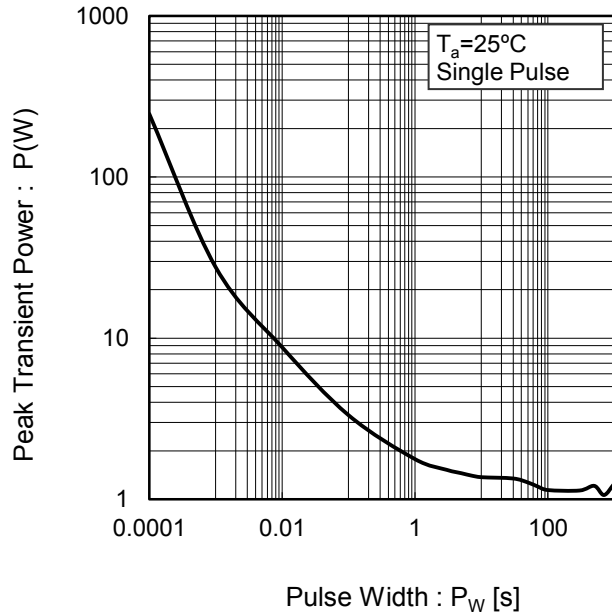

Fig.4 Single Pulse Maximum Power dissipation



●Electrical characteristic curves

Fig.5 Typical Output Characteristics(I)

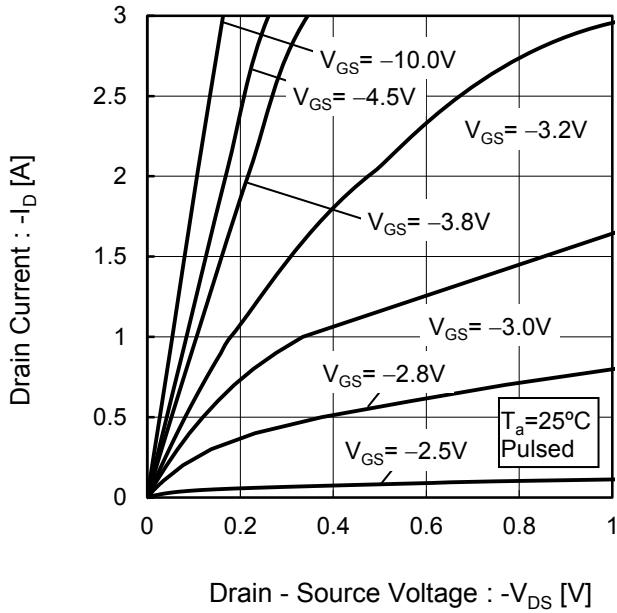

Fig.6 Typical Output Characteristics(II)

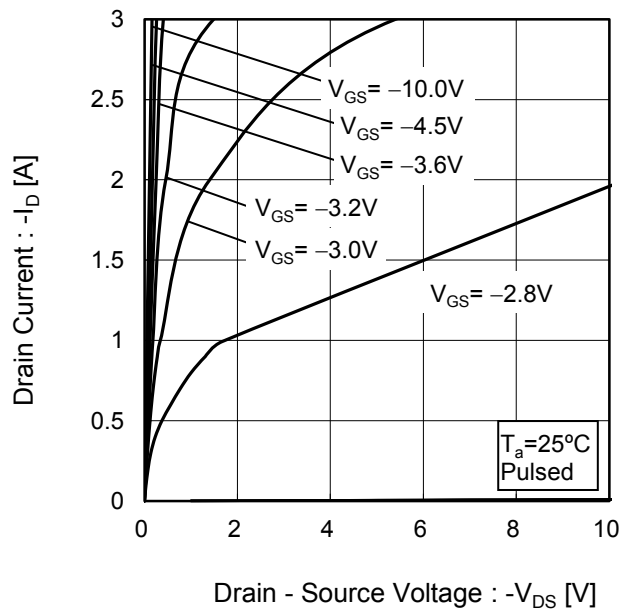

Fig.7 Breakdown Voltage vs. Junction Temperature

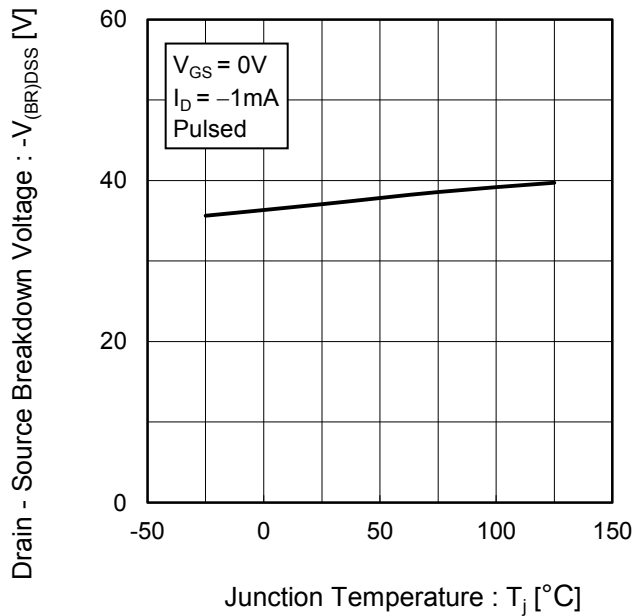
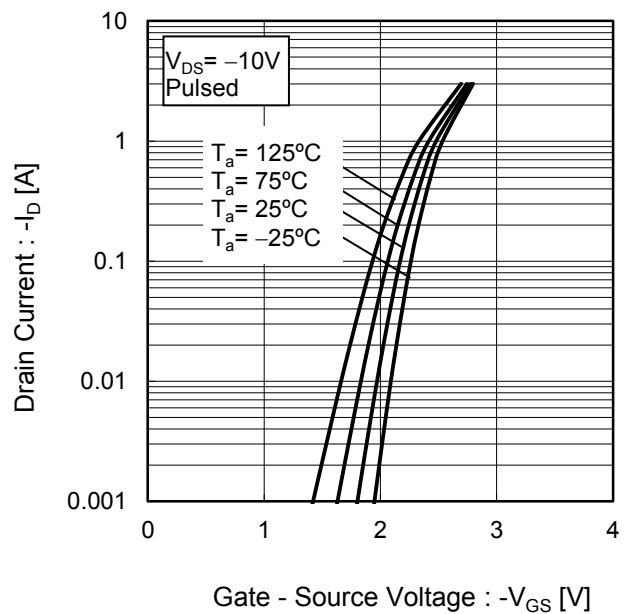

Fig.8 Typical Transfer Characteristics



●Electrical characteristic curves

Fig.9 Gate Threshold Voltage vs. Junction Temperature

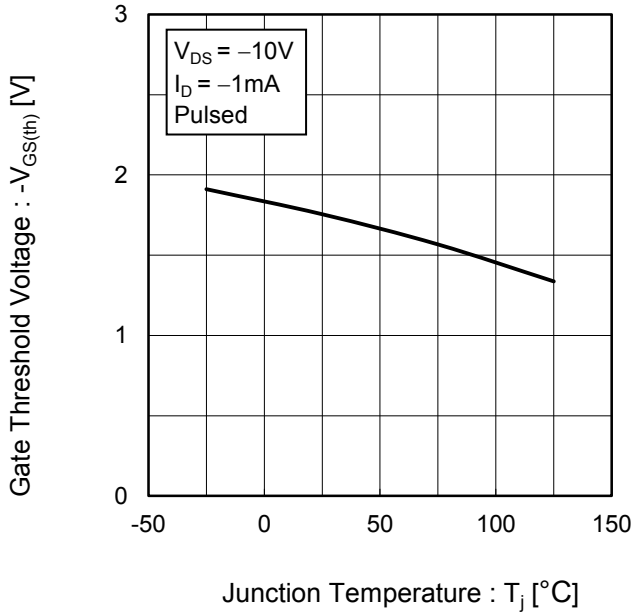

Fig.10 Transconductance vs. Drain Current

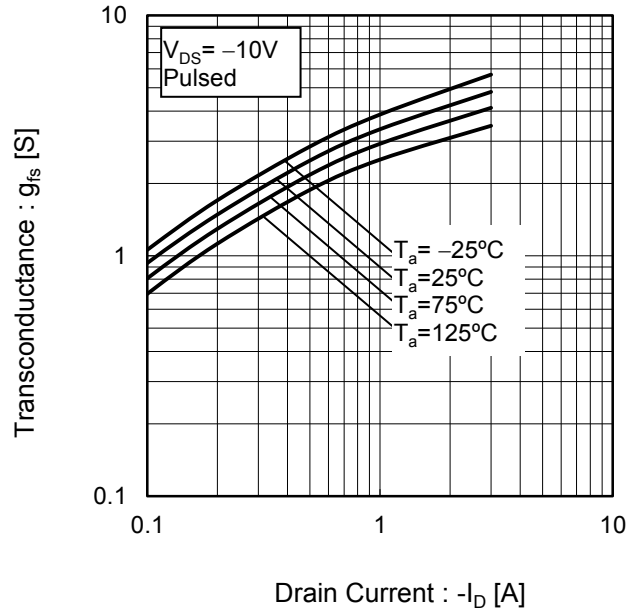

Fig.11 Drain Current Derating Curve

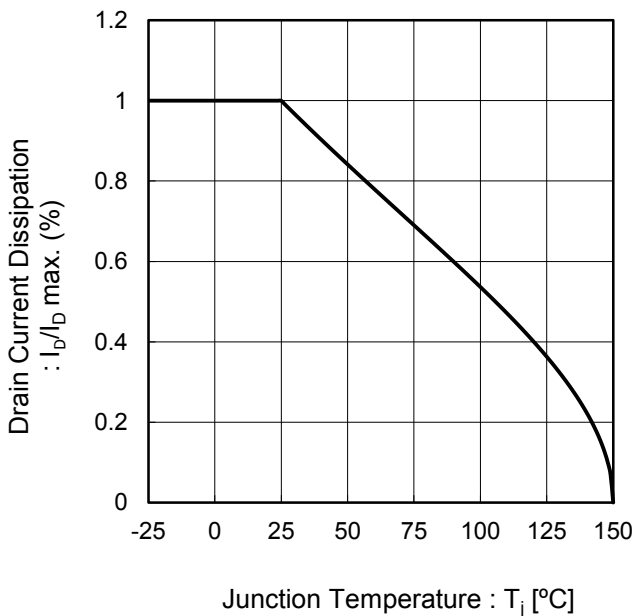
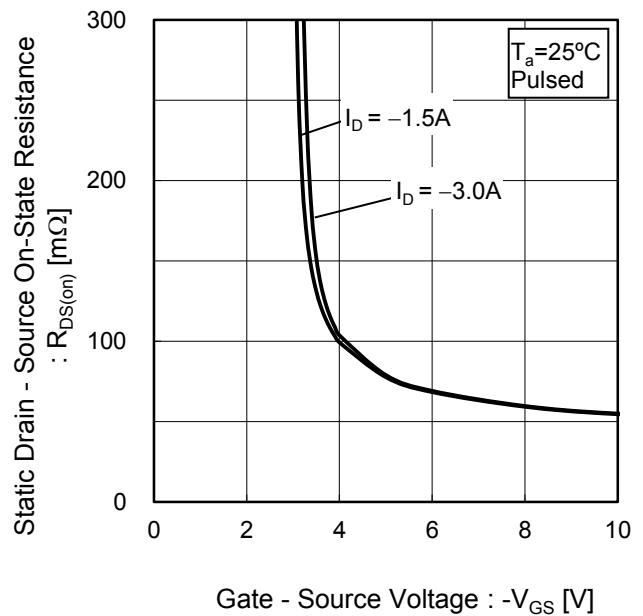

Fig.12 Static Drain - Source On - State Resistance vs. Gate Source Voltage



●Electrical characteristic curves

Fig.13 Static Drain - Source On - State Resistance vs. Drain Current(I)

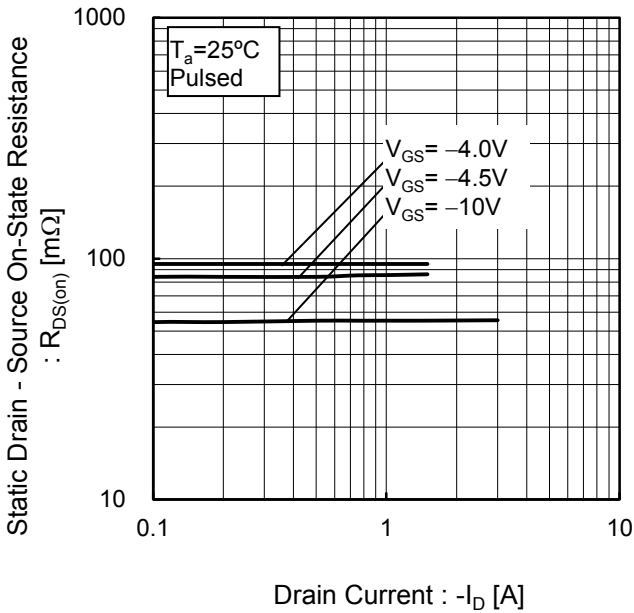

Fig.14 Static Drain - Source On - State Resistance vs. Junction Temperature

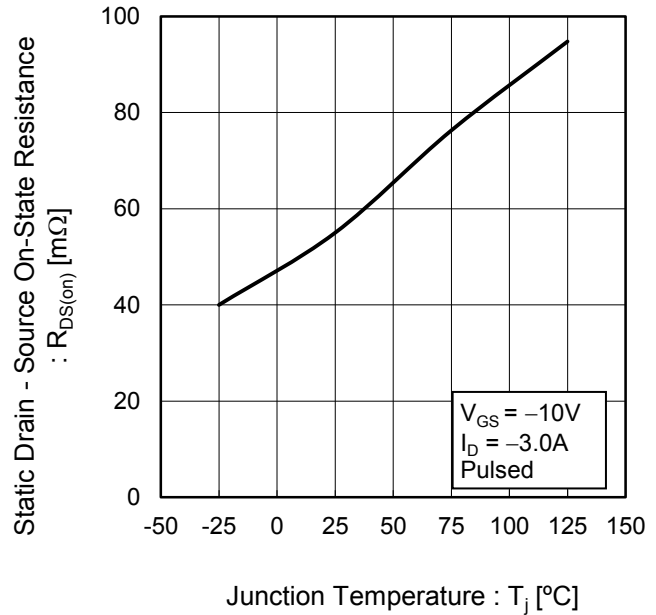

Fig.15 Static Drain - Source On - State Resistance vs. Drain Current(II)

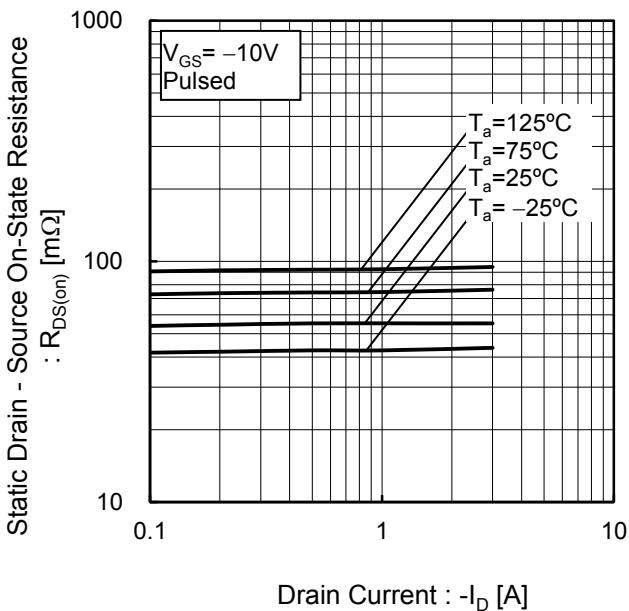
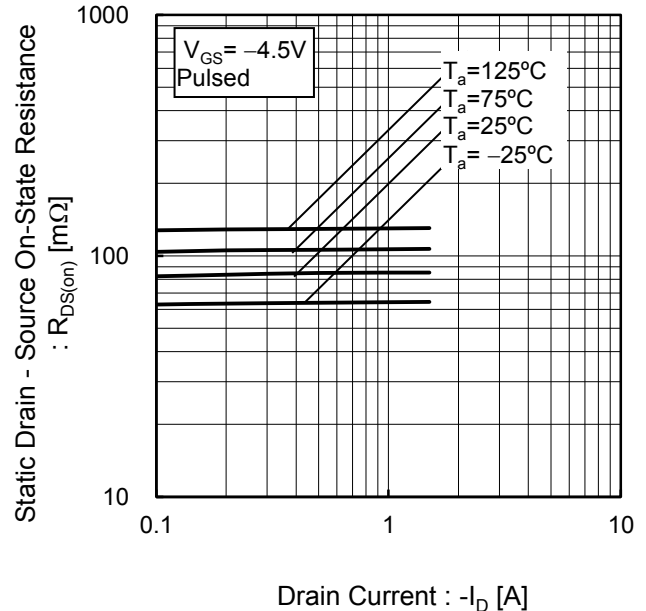

Fig.16 Static Drain-Source On-State Resistance vs. Drain Current(III)



●Electrical characteristic curves

Fig.17 Static Drain - Source On - State Resistance vs. Drain Current(IV)

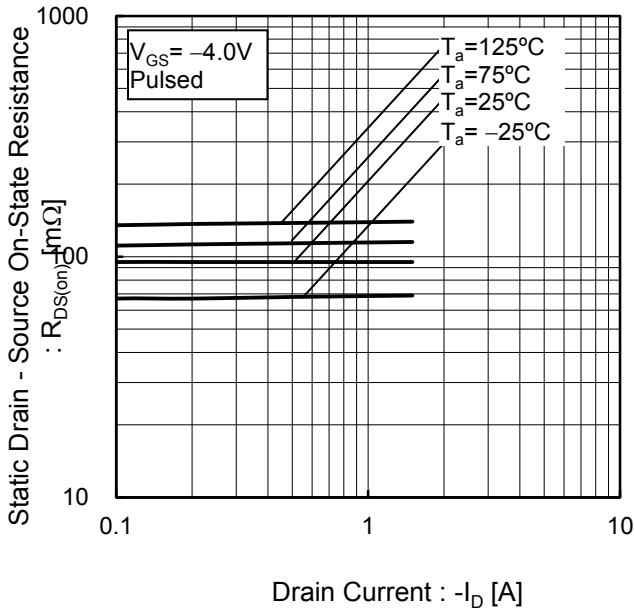

Fig.18 Typical Capacitance vs. Drain - Source Voltage

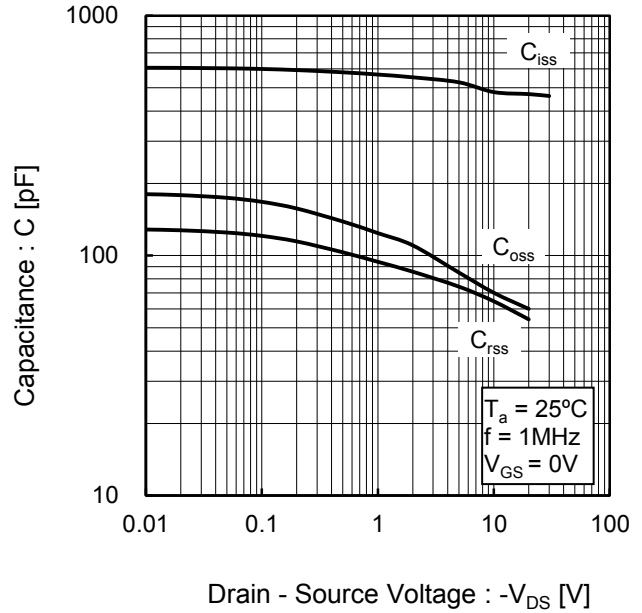

Fig.19 Switching Characteristics

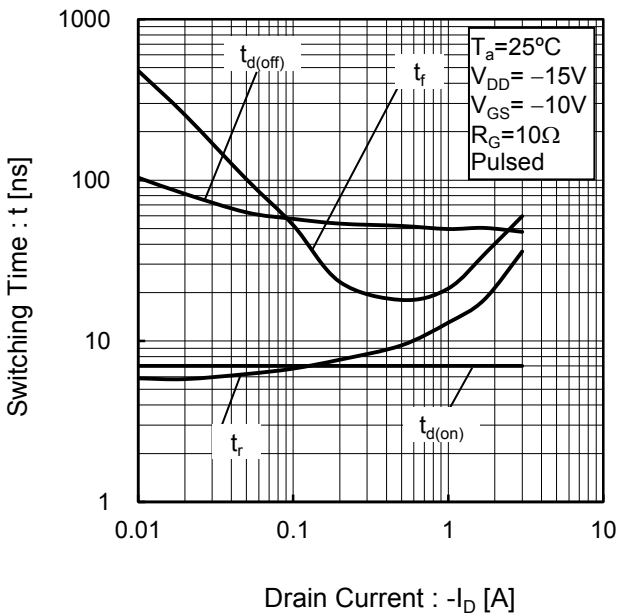
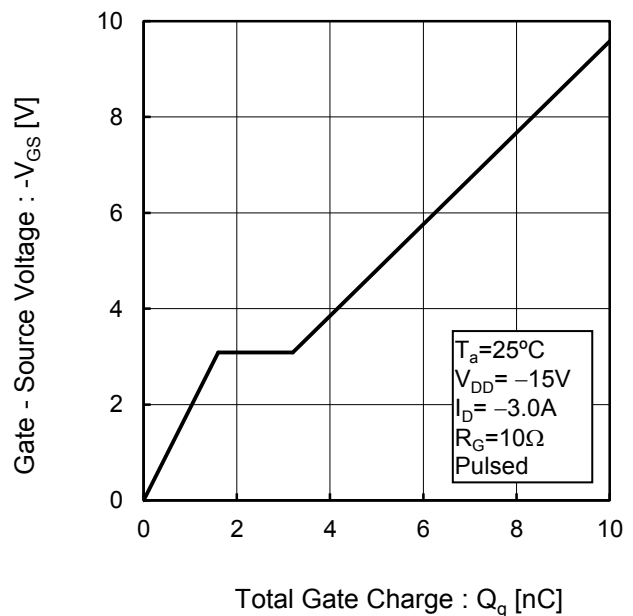
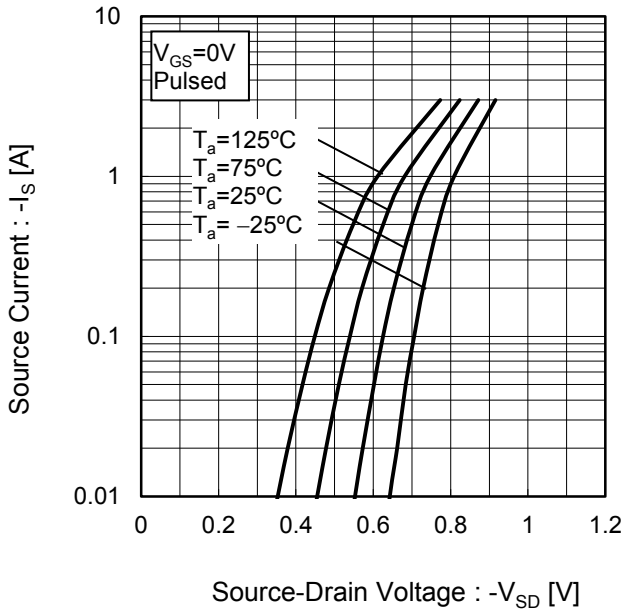

Fig.20 Dynamic Input Characteristics



●Electrical characteristic curves

Fig.21 Source Current vs. Source Drain Voltage



● Measurement circuits

Fig.1-1 Switching Time Measurement Circuit

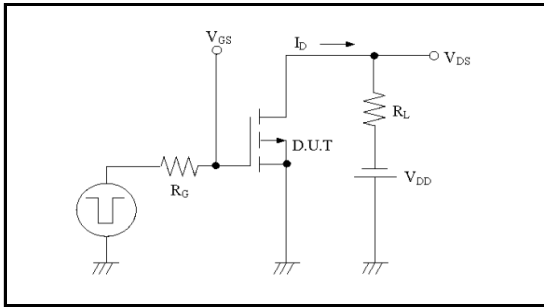

Fig.1-2 Switching Waveforms

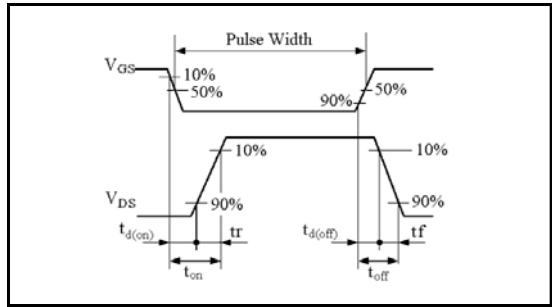

Fig.2-1 Gate Charge Measurement Circuit

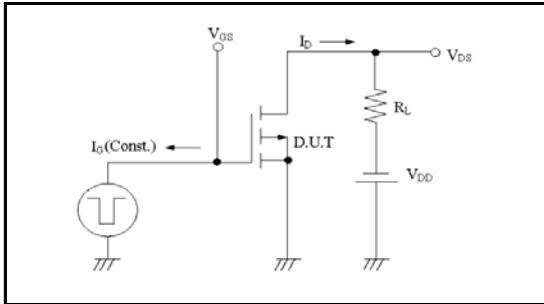
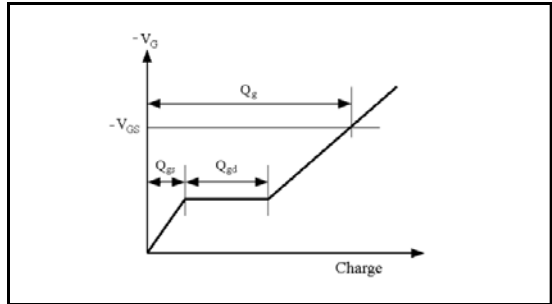
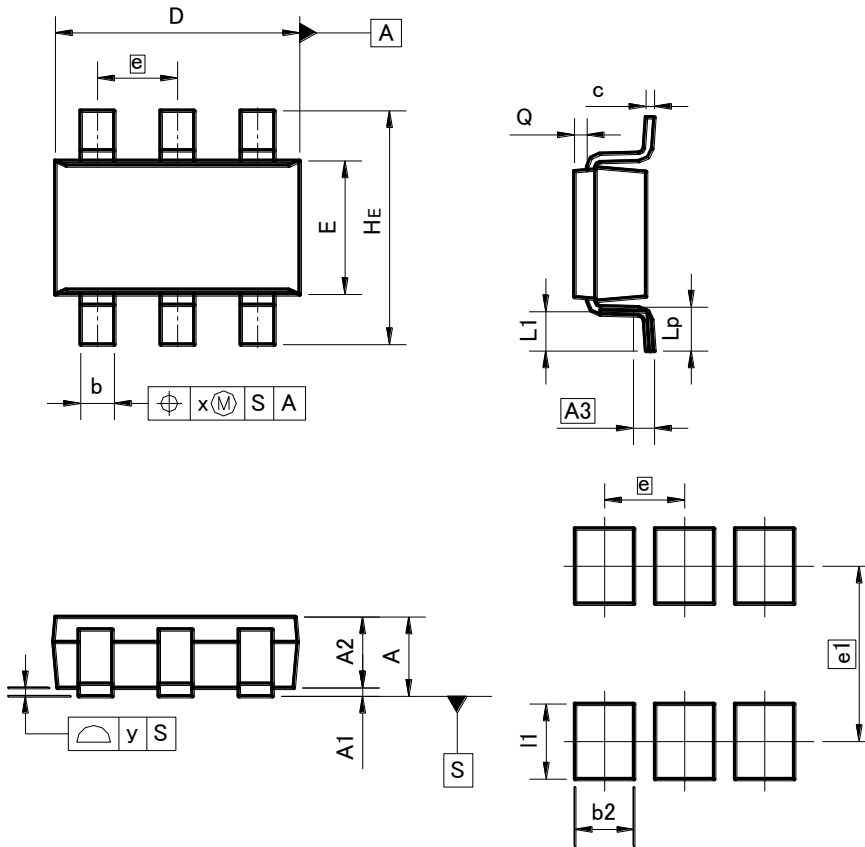

Fig.2-2 Gate Charge Waveform



●Dimensions (Unit : mm)

TSMT6



Pattern of terminal position areas

| DIM | MILIMETERS | | INCHES | |
|-----|------------|------|--------|-------|
| | MIN | MAX | MIN | MAX |
| A | - | 1.00 | - | 0.039 |
| A1 | 0.00 | 0.10 | 0 | 0.004 |
| A2 | 0.75 | 0.95 | 0.03 | 0.037 |
| A3 | 0.25 | | 0.01 | |
| b | 0.35 | 0.50 | 0.014 | 0.02 |
| c | 0.10 | 0.26 | 0.004 | 0.01 |
| D | 2.80 | 3.00 | 0.11 | 0.118 |
| E | 1.50 | 1.80 | 0.059 | 0.071 |
| e | 0.95 | | 0.04 | |
| HE | 2.60 | 3.00 | 0.102 | 0.118 |
| L1 | 0.30 | 0.60 | 0.012 | 0.024 |
| Lp | 0.40 | 0.70 | 0.016 | 0.028 |
| Q | 0.05 | 0.25 | 0.002 | 0.01 |
| x | - | 0.20 | - | 0.008 |
| y | - | 0.10 | - | 0.004 |

| DIM | MILIMETERS | | INCHES | |
|-----|------------|------|--------|-------|
| | MIN | MAX | MIN | MAX |
| e1 | 2.10 | | 0.08 | |
| b2 | - | 0.70 | - | 0.028 |
| I1 | - | 0.90 | - | 0.035 |

Dimension in mm/inches

Notes

No copying or reproduction of this document, in part or in whole, is permitted without the consent of ROHM Co.,Ltd.

The content specified herein is subject to change for improvement without notice.

The content specified herein is for the purpose of introducing ROHM's products (hereinafter "Products"). If you wish to use any such Product, please be sure to refer to the specifications, which can be obtained from ROHM upon request.

Examples of application circuits, circuit constants and any other information contained herein illustrate the standard usage and operations of the Products. The peripheral conditions must be taken into account when designing circuits for mass production.

Great care was taken in ensuring the accuracy of the information specified in this document. However, should you incur any damage arising from any inaccuracy or misprint of such information, ROHM shall bear no responsibility for such damage.

The technical information specified herein is intended only to show the typical functions of and examples of application circuits for the Products. ROHM does not grant you, explicitly or implicitly, any license to use or exercise intellectual property or other rights held by ROHM and other parties. ROHM shall bear no responsibility whatsoever for any dispute arising from the use of such technical information.

The Products specified in this document are intended to be used with general-use electronic equipment or devices (such as audio visual equipment, office-automation equipment, communication devices, electronic appliances and amusement devices).

The Products specified in this document are not designed to be radiation tolerant.

While ROHM always makes efforts to enhance the quality and reliability of its Products, a Product may fail or malfunction for a variety of reasons.

Please be sure to implement in your equipment using the Products safety measures to guard against the possibility of physical injury, fire or any other damage caused in the event of the failure of any Product, such as derating, redundancy, fire control and fail-safe designs. ROHM shall bear no responsibility whatsoever for your use of any Product outside of the prescribed scope or not in accordance with the instruction manual.

The Products are not designed or manufactured to be used with any equipment, device or system which requires an extremely high level of reliability the failure or malfunction of which may result in a direct threat to human life or create a risk of human injury (such as a medical instrument, transportation equipment, aerospace machinery, nuclear-reactor controller, fuel-controller or other safety device). ROHM shall bear no responsibility in any way for use of any of the Products for the above special purposes. If a Product is intended to be used for any such special purpose, please contact a ROHM sales representative before purchasing.

If you intend to export or ship overseas any Product or technology specified herein that may be controlled under the Foreign Exchange and the Foreign Trade Law, you will be required to obtain a license or permit under the Law.



Thank you for your accessing to ROHM product informations.
More detail product informations and catalogs are available, please contact us.

ROHM Customer Support System

<http://www.rohm.com/contact/>