

Description

The F1478 is a high gain, two-stage RF Amplifier designed to operate within the 1.8GHz to 5.0GHz frequency range. Using a single 5V power supply and only 140mA of I_{CC} , the F1478 provides 30.3dB of Gain and 1.6dB of Noise Figure with up to +35.73dBm OIP3 and 23.6dBm OP1dB at 3.55GHz.

The F1478 is packaged in a 3 × 3 mm, 16-VFQFPN, with matched 50Ω input and output impedances for ease of integration into the signal path.

Competitive Advantage

- Combines a two-stage RF amplifier in a single, compact 3mm × 3mm VFQFPN package
- Excellent performance over exceptionally wide bandwidths
- Single device provides adjustable linearity versus current via an external resistor

Typical Applications

- 4G / 5G Cellular Basestations
- Multi-mode, Multi-carrier Transmitters
- Active Antenna Systems

Features

- RF range: 1.8GHz to 5.0GHz
- 30.3dB typical gain at 3.55GHz
- 1.6dB NF at 3.55GHz
- Adjustable OIP3 performance
 - +35.7dBm OIP3 at 3.55GHz and 140mA of bias current
 - +32.2dBm OIP3 at 3.55GHz and 100mA of bias current
- Adjustable OP1dB performance
 - +23.6dBm OP1dB at 3.55GHz and 140mA of bias current
 - +22.8dBm OP1dB at 3.55GHz and 100mA of bias current
- 5V power supply
- Adjustable I_{CC} ranging from 80mA to 160mA
- 50Ω Single-ended Input and Output Impedances
- 1.8V Logic Compatible Standby Mode for Power Savings
- Operating temperature (T_{EPAD}) range: -40°C to +115°C
- 3 × 3 mm 16-VFQFPN package

Block Diagram

Figure 1. Block Diagram

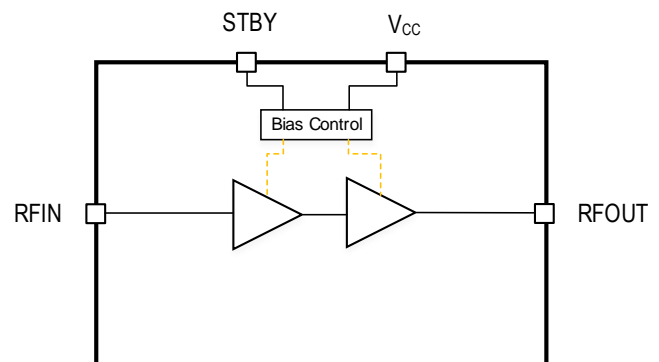

Contents

Description.....	1
Competitive Advantage	1
Typical Applications.....	1
Features	1
Block Diagram	1
Pin Assignments.....	7
Pin Descriptions.....	8
Absolute Maximum Ratings.....	9
Recommended Operating Conditions	10
Electrical Characteristics – General	11
Electrical Characteristics – Band 2p0 (1.8GHz to 2.2GHz) / Low Power Mode	12
Electrical Characteristics – Band 2p0 (1.8GHz to 2.2GHz) / High Power Mode.....	13
Electrical Characteristics – Band 2p5 (2.3GHz to 2.7GHz) / Low Power Mode	14
Electrical Characteristics – Band 2p5 (2.3GHz to 2.7GHz) / High Power Mode.....	15
Electrical Characteristics – Band 3p5 (3.3GHz to 3.8GHz) / Low Power Mode	16
Electrical Characteristics – Band 3p5 (3.3GHz to 3.8GHz) / High Power Mode.....	17
Electrical Characteristics – Band 4p7 (4.4GHz to 5.0GHz) / Low Power Mode	18
Electrical Characteristics – Band 4p7 (4.4GHz to 5.0GHz) / High Power Mode.....	19
Thermal Characteristics.....	20
Typical Operating Conditions	20
Standby	37
Typical Application Circuit	37
Evaluation Kit Picture	38
Evaluation Kit Operation.....	42
Power Supply Setup.....	42
Power-On Procedure.....	43
Power-Off Procedure.....	43
Application Information.....	43
Performance	43
Standby Mode (STBY).....	43
Digital Pin Voltage and Resistance Values.....	43
Power Supplies.....	44
Package Outline Drawings	45
Ordering Information.....	45
Marking Diagram	45
Revision History.....	46

List of Figures

Figure 1. Block Diagram	1
Figure 2. Pin Assignments for 3 × 3 × 0.9 mm VFQFPN Package – Top View	7
Figure 3. Gain - Low Power Mode	21
Figure 4. Gain - High Power Mode	21
Figure 5. Input Return Loss - Low Power Mode	21
Figure 6. Input Return Loss - High Power Mode	21
Figure 7. Output Return Loss - Low Power Mode.....	21
Figure 8. Output Return Loss – High Power Mode.....	21
Figure 9. Gain - Low Power Mode, Broadband	22
Figure 10. Gain - High Power Mode, Broadband.....	22
Figure 11. Input Return Loss - Low Power Mode, Broadband.....	22
Figure 12. Input Return Loss - High Power Mode, Broadband	22
Figure 13. Output Return Loss - Low Power Mode, Broadband.....	22
Figure 14. Output Return Loss – High Power Mode, Broadband	22
Figure 15. Reverse Isolation - Low Power Mode	23
Figure 16. Reverse Isolation - High Power Mode	23
Figure 17. Standby Mode Gain.....	23
Figure 18. Current versus Power Supply Voltage.....	23
Figure 19. Standby Mode Reverse Isolation.....	23
Figure 20. Standby Current versus Power Supply Voltage.....	23
Figure 21. Output IP3 - Low Power Mode	24
Figure 22. Output IP3 - High Power Mode.....	24
Figure 23. Output Compression - Low Power Mode.....	24
Figure 24. Output Compression - High Power Mode	24
Figure 25. Noise Figure - Low Power Mode	24
Figure 26. Noise Figure - High Power Mode	24
Figure 27. Gain - Low Power Mode	25
Figure 28. Gain - High Power Mode	25
Figure 29. Input Return Loss - Low Power Mode	25
Figure 30. Input Return Loss - High Power Mode	25
Figure 31. Output Return Loss - Low Power Mode.....	25
Figure 32. Output Return Loss – High Power Mode.....	25
Figure 33. Gain - Low Power Mode, Broadband	26
Figure 34. Gain - High Power Mode, Broadband.....	26
Figure 35. Input Return Loss - Low Power Mode, Broadband.....	26
Figure 36. Input Return Loss - High Power Mode, Broadband	26
Figure 37. Output Return Loss - Low Power Mode, Broadband.....	26
Figure 38. Output Return Loss – High Power Mode, Broadband	26
Figure 39. Reverse Isolation - Low Power Mode.....	27

Figure 40. Reverse Isolation - High Power Mode	27
Figure 41. Standby Mode Gain	27
Figure 42. Current versus Power Supply Voltage	27
Figure 43. Standby Mode Reverse Isolation	27
Figure 44. Standby Current versus Power Supply Voltage	27
Figure 45. Output IP3 - Low Power Mode	28
Figure 46. Output IP3 - High Power Mode	28
Figure 47. Output Compression - Low Power Mode	28
Figure 48. Output Compression - High Power Mode	28
Figure 49. Noise Figure - Low Power Mode	28
Figure 50. Noise Figure - High Power Mode	28
Figure 51. Gain - Low Power Mode	29
Figure 52. Gain - High Power Mode	29
Figure 53. Input Return Loss - Low Power Mode	29
Figure 54. Input Return Loss - High Power Mode	29
Figure 55. Output Return Loss - Low Power Mode	29
Figure 56. Output Return Loss – High Power Mode	29
Figure 57. Gain - Low Power Mode, Broadband	30
Figure 58. Gain - High Power Mode, Broadband	30
Figure 59. Input Return Loss - Low Power Mode, Broadband	30
Figure 60. Input Return Loss - High Power Mode, Broadband	30
Figure 61. Output Return Loss - Low Power Mode, Broadband	30
Figure 62. Output Return Loss – High Power Mode, Broadband	30
Figure 63. Reverse Isolation - Low Power Mode	31
Figure 64. Reverse Isolation - High Power Mode	31
Figure 65. Standby Mode Gain versus Frequency	31
Figure 66. Current versus Power Supply Voltage	31
Figure 67. Standby Mode Reverse Isolation	31
Figure 68. Standby Current versus Power Supply Voltage	31
Figure 69. Output IP3 - Low Power Mode	32
Figure 70. Output IP3 - High Power Mode	32
Figure 71. Output Compression - Low Power Mode	32
Figure 72. Output Compression - High Power Mode	32
Figure 73. Noise Figure - Low Power Mode	32
Figure 74. Noise Figure - High Power Mode	32
Figure 75. Gain - Low Power Mode	33
Figure 76. Gain - High Power Mode	33
Figure 77. Input Return Loss - Low Power Mode	33
Figure 78. Input Return Loss - High Power Mode	33
Figure 79. Output Return Loss - Low Power Mode	33

Figure 80. Output Return Loss – High Power Mode	33
Figure 81. Gain - Low Power Mode, Broadband	34
Figure 82. Gain - High Power Mode, Broadband.....	34
Figure 83. Input Return Loss - Low Power Mode, Broadband.....	34
Figure 84. Input Return Loss - High Power Mode, Broadband.....	34
Figure 85. Output Return Loss - Low Power Mode, Broadband.....	34
Figure 86. Output Return Loss – High Power Mode, Broadband	34
Figure 87. Reverse Isolation - Low Power Mode.....	35
Figure 88. Reverse Isolation - High Power Mode	35
Figure 89. Standby Mode Gain.....	35
Figure 90. Current versus Power Supply Voltage.....	35
Figure 91. Standby Mode Reverse Isolation.....	35
Figure 92. Standby Current versus Power Supply Voltage.....	35
Figure 93. Output IP3 - Low Power Mode	36
Figure 94. Output IP3 - High Power Mode.....	36
Figure 95. Output Compression - Low Power Mode.....	36
Figure 96. Output Compression - High Power Mode.....	36
Figure 97. Noise Figure - Low Power Mode	36
Figure 98. Noise Figure - High Power Mode	36
Figure 99. Typical Application Circuit	37
Figure 100. Top View	38
Figure 101. Bottom View	38
Figure 102. Electrical Schematic for the Evaluation Board.....	39
Figure 103. Power Supply Connections	42
Figure 104. Standby Connection.....	42
Figure 105. Control Pin Interface for Signal Integrity.....	44

List of Tables

Table 1.	Pin Descriptions.....	8
Table 2.	Absolute Maximum Ratings.....	9
Table 3.	Recommended Operating Conditions	10
Table 4.	Electrical Characteristics	11
Table 5.	Electrical Characteristics – Band 2p0 (1.8GHz to 2.2GHz) / Low Power Mode	12
Table 6.	Electrical Characteristics – Band 2p0 (1.8GHz to 2.2GHz) / High Power Mode.....	13
Table 7.	Electrical Characteristics – Band 2p5 (2.3GHz to 2.7GHz) / Low Power Mode	14
Table 8.	Electrical Characteristics – Band 2p5 (2.3GHz to 2.7GHz) / High Power Mode.....	15
Table 9.	Electrical Characteristics – Band 3p5 (3.3GHz to 3.8GHz) / Low Power Mode	16
Table 10.	Electrical Characteristics – Band 3p5 (3.3GHz to 3.8GHz) / High Power Mode.....	17
Table 11.	Electrical Characteristics – Band 4p7 (4.4GHz to 5.0GHz) / Low Power Mode	18
Table 12.	Electrical Characteristics – Band 4p7 (4.4GHz to 5.0GHz) / High Power Mode.....	19
Table 13.	Package Thermal Characteristics.....	20
Table 14.	Standby Truth Table	37
Table 15.	Bill of Material (BOM)	40
Table 16.	Digital Pin Voltages and Resistance.....	43

Pin Assignments

Figure 2. Pin Assignments for 3 × 3 × 0.9 mm VFQFPN Package – Top View

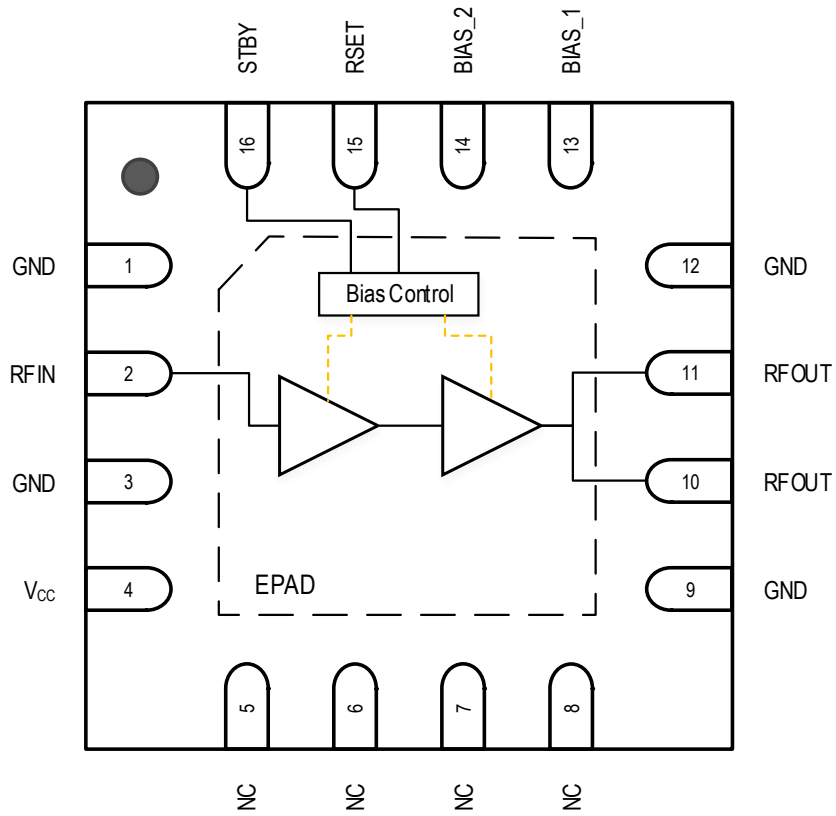

Pin Descriptions

Table 1. Pin Descriptions

Number	Name	Description
1, 3, 9, 12	GND	Internally grounded. This pin must be grounded with a via as close to the pin as possible.
2	RFIN	RF input internally matched to 50Ω. Must use an external DC block.
4	V _{CC} -RF	Pull up to V _{CC} through inductor and use bypass capacitors as close to the pin as possible. In addition to supplying the device with a DC voltage, there is also an RF signal present.
5-8	NC	No internal connection. These pins can be left unconnected, or be connected to ground (recommended). Use a via as close to the pin as possible if grounded.
10, 11	RFOUT	RF output. Pull up to V _{CC} through inductor. Must use external DC block.
13	BIAS_1	Connect via resistor to a common V _{CC} and use bypass capacitors as shown in the Typical Application Circuit. Place network as close to the pin as possible.
14	BIAS_2	Connect via inductor to ground.
15	RSET	Connect via resistor to ground. Resistor value sets the device into its low or high power mode.
16	STBY	Standby pin. With Logic LOW applied to this pin the amplifier is powered off. With Logic HIGH applied to this pin (or if the pin is left unconnected), the part is in full operation mode. Pin is 1.8V logic compatible.
	— EPAD	Exposed Pad. Internally connected to ground. Solder this exposed pad to a PCB pad that uses multiple ground vias to provide heat transfer out of the device into the PCB ground planes. These multiple ground vias are also required to achieve the noted RF performance.

Absolute Maximum Ratings

Stresses above those listed below may cause permanent damage to the device. Functional operation of the device at these or any other conditions above those indicated in the operational section of this specification is not implied. Exposure to absolute maximum rating conditions for extended periods may affect device reliability.

Table 2. Absolute Maximum Ratings

Parameter	Symbol	Minimum	Maximum	Units
V _{CC} to GND	V _{CC}	-0.3	+6.0	V
STBY	V _{CTL}	-0.3	Lower of (5.0, V _{CC} + 0.25)	V
BIAS_1 (into pin)	I _{BIAS_1}		20	mA
BIAS_2 (out of pin)	I _{BIAS_2}		10	mA
RFIN externally applied DC voltage	V _{RFIN}	-0.5	+0.5	V
RFOUT externally applied DC voltage	V _{RFOUT}	-0.5	+5.5	V
Maximum CW Input Power applied for 24 hours. V _{CC} = 5V, T _{EPAD} = 115°C, input / output VSWR < 2:1 based on a 50Ω system. Standby = logic HIGH: ON state. [a]	P _{MAX_IN_ON}		21	dBm
Maximum CW Input Power applied for 24 hour. V _{CC} = 5V, T _{EPAD} = 115°C, input / output VSWR < 2:1 based on a 50Ω system. Standby = logic LOW: OFF state. [a]	P _{MAX_IN_OFF}		21	
Continuous Power Dissipation	P _{DISS}		1.8	W
Storage Temperature Range	T _{st}	-65	150	°C
Lead Temperature (soldering, 10s)			260	°C
ElectroStatic Discharge – HBM (JEDEC/ESDA JS-001-2012)	V _{ESDHBM}		500 (Class 1B)	V
ElectroStatic Discharge – CDM (JEDEC 22-C101F)	V _{ESDCDM}		1000 (Class C3)	V

[a] Exposure to these maximum RF levels can result in significantly higher I_{cc} current draw due to overdriving the amplifier stages.

Recommended Operating Conditions

Table 3. Recommended Operating Conditions

Parameter	Symbol	Condition	Minimum	Typical	Maximum	Units
Power Supply Voltage	V_{CC}		3.15		5.25	V
Operating Temperature Range	T_{EPAD}	Exposed Paddle	-40		+115	°C
Junction Temperature – Amplifier	T_j				150	°C
RF Frequency Range [a]	f_{RF}	Band 2p0 Tuning Set	1.8		2.2	GHz
		Band 2p5 Tuning Set	2.3		2.7	
		Band 3p5 Tuning Set	3.3		3.8	
		Band 4p7 Tuning Set	4.4		5.0	
RFIN Port Impedance	Z_{RFI}	Single Ended		50		Ω
RFOUT Port Impedance	Z_{RFO}	Single Ended		50		Ω

[a] Using external matching, gain flatness is optimized from 1.8GHz to 2.2GHz (Band 2p0 Tuning Set), 2.3GHz to 2.7GHz (Band 2p5H Tuning Set), 3.3GHz to 3.8GHz (Band 3p5 Tuning Set), and 4.4GHz to 5.0GHz (Band 4p7 Tuning Set).

Electrical Characteristics – General

See Typical Application Circuit. Specifications apply when operated as a TX amplifier with tuning optimized for desired band of interest, $V_{CC} = +5.0V$, $T_{EPAD} = +25^{\circ}C$, $STBY = HIGH$, $Z_S = Z_L = 50\Omega$, Evaluation Kit trace and connector losses are de-embedded, unless otherwise stated.

Table 4. Electrical Characteristics

Parameter	Symbol	Condition	Minimum	Typical	Maximum	Units
Logic Input High	V_{IH}		1.17 ^[a]		V_{CC}	V
Logic Input Low	V_{IL}		-0.3		0.63	V
Logic Current	I_{STBY}	STBY	-10		+10	μA
Quiescent Current ^[b]	I_{CC_QL}	Low Power Mode: R3 = 16k Ω		100	130	mA
	I_{CC_QH}	High Power Mode: R3 = 10k Ω		140	178	
Standby Current	I_{CC_STBY}	STBY = LOW		1.5		mA
Standby Switching Time	t_{ON}	50% STBY control to within 0.5dB of the on-state final gain value		270		ns
	t_{OFF}	50% STBY control to 30dBc below nominal gain value		60		

[a] Specifications in the minimum/maximum columns that are shown in **bold italics** are guaranteed by test. Specifications in these columns that are not shown in bold italics are guaranteed by design characterization.

[b] I_{CC} refers to the nominal small signal bias current.

Electrical Characteristics – Band 2p0 (1.8GHz to 2.2GHz) / Low Power Mode

See Typical Application Circuit. Specifications apply when operated as a TX amplifier with tuning optimized for the 1.8GHz to 2.2GHz band, $V_{CC} = +5.0V$, $I_{CC} = 100mA$, $R3 = 16k\Omega$, $f_{RF} = 2.0GHz$, $T_{EPAD} = +25^{\circ}C$, $STBY = HIGH$, $Z_S = Z_L = 50\Omega$, Evaluation Kit trace and connector losses are de-embedded, unless otherwise stated.

Table 5. Electrical Characteristics – Band 2p0 (1.8GHz to 2.2GHz) / Low Power Mode

Parameter	Symbol	Condition	Minimum	Typical	Maximum	Units
Gain	G			29.1		dB
Gain Flatness	G_{FLAT}	$f_{RF} = 1.8GHz$ to $2.2GHz$		0.7		dB
Gain Variation Over Temperature	G_{TEMP}	$T_{EPAD} = -40^{\circ}C$ to $+115^{\circ}C$, referenced to $T_{EPAD} = 25^{\circ}C$		+0.7 / -1.6		dB
STBY Mode Gain	G_{STBY}	STBY = logic LOW $P_{IN} \leq -15dBm$ $f_{RF} = 1.8GHz$ to $2.2GHz$		-45		dB
RF Input Return Loss	RL_{RFIN}	$f_{RF} = 1.8GHz$ to $2.2GHz$		9.4		dB
RF Output Return Loss	RL_{RFOUT}	$f_{RF} = 1.8GHz$ to $2.2GHz$		17.6		dB
Reverse Isolation	ISO_{REV}			50		dB
Noise Figure	NF			1.7		dB
Output Third Order Intercept Point	OIP3	$P_{OUT} = +2dBm$ / tone 1MHz tone separation		32		dBm
Output 1dB Compression Point	OP1dB			23.3		dBm

Electrical Characteristics – Band 2p0 (1.8GHz to 2.2GHz) / High Power Mode

See Typical Application Circuit. Specifications apply when operated as a TX amplifier with tuning optimized for the 1.8GHz to 2.2GHz band, $V_{CC} = +5.0V$, $I_{CC} = 140mA$, $R3 = 10k\Omega$, $f_{RF} = 2.0GHz$, $T_{EPAD} = +25^{\circ}C$, $STBY = HIGH$, $Z_S = Z_L = 50\Omega$, Evaluation Kit trace and connector losses are de-embedded, unless otherwise stated.

Table 6. Electrical Characteristics – Band 2p0 (1.8GHz to 2.2GHz) / High Power Mode

Parameter	Symbol	Condition	Minimum	Typical	Maximum	Units
Gain	G			29.9		dB
Gain Flatness	G_{FLAT}	$f_{RF} = 1.8GHz$ to 2.2GHz		0.7		dB
Gain Variation Over Temperature	G_{TEMP}	$T_{EPAD} = -40^{\circ}C$ to $+115^{\circ}C$, referenced to $T_{EPAD} = 25^{\circ}C$		+0.7 / -1.6		dB
STBY Mode Gain	G_{STBY}	STBY = logic LOW $P_{IN} \leq -15dBm$ $f_{RF} = 1.8GHz$ to 2.2GHz		-45		dB
RF Input Return Loss	RL_{RFIN}	$f_{RF} = 1.8GHz$ to 2.2GHz		8.0		dB
RF Output Return Loss	RL_{RFOUT}	$f_{RF} = 1.8GHz$ to 2.2GHz		16.0		dB
Reverse Isolation	ISO_{REV}			50		dB
Noise Figure	NF			1.8		dB
Output Third Order Intercept Point	OIP3	$P_{OUT} = +2dBm$ / tone 1MHz tone separation		34,8		dBm
Output 1dB Compression Point	OP1dB			24.0		dBm

Electrical Characteristics – Band 2p5 (2.3GHz to 2.7GHz) / Low Power Mode

See Typical Application Circuit. Specifications apply when operated as a TX amplifier with tuning optimized for the 2.3GHz to 2.7GHz band, $V_{CC} = +5.0V$, $I_{CC} = 100mA$, $R3 = 16k\Omega$, $f_{RF} = 2.5GHz$, $T_{EPAD} = +25^{\circ}C$, $STBY = HIGH$, $Z_S = Z_L = 50\Omega$, Evaluation Kit trace and connector losses are de-embedded, unless otherwise stated.

Table 7. Electrical Characteristics – Band 2p5 (2.3GHz to 2.7GHz) / Low Power Mode

Parameter	Symbol	Condition	Minimum	Typical	Maximum	Units
Gain	G			29.3		dB
Gain Flatness	G_{FLAT}	$f_{RF} = 2.3GHz$ to 2.7GHz		0.6		dB
Gain Variation Over Temperature	G_{TEMP}	$T_{EPAD} = -40^{\circ}C$ to $+115^{\circ}C$, referenced to $T_{EPAD} = 25^{\circ}C$		+0.7 / -1.0		dB
STBY Mode Gain	G_{STBY}	STBY = logic LOW $P_{IN} \leq -15dBm$ $f_{RF} = 2.3GHz$ to 2.7GHz		-46		dB
RF Input Return Loss	RL_{RFIN}	$f_{RF} = 2.3GHz$ to 2.7GHz		9.8		dB
RF Output Return Loss	RL_{RFOUT}	$f_{RF} = 2.3GHz$ to 2.7GHz		12.6		dB
Reverse Isolation	ISO_{REV}			49		dB
Noise Figure	NF			1.7		dB
Output Third Order Intercept Point	OIP3	$P_{OUT} = +2dBm$ / tone 1MHz tone separation		32.2		dBm
Output 1dB Compression Point	OP1dB			22.8		dBm

Electrical Characteristics – Band 2p5 (2.3GHz to 2.7GHz) / High Power Mode

See Typical Application Circuit. Specifications apply when operated as a TX amplifier with tuning optimized for the 2.3GHz to 2.7GHz band, $V_{CC} = +5.0V$, $I_{CC} = 140mA$, $R3 = 10k\Omega$, $f_{RF} = 2.5GHz$, $T_{EPAD} = +25^{\circ}C$, $STBY = HIGH$, $Z_S = Z_L = 50\Omega$, Evaluation Kit trace and connector losses are de-embedded, unless otherwise stated.

Table 8. Electrical Characteristics – Band 2p5 (2.3GHz to 2.7GHz) / High Power Mode

Parameter	Symbol	Condition	Minimum	Typical	Maximum	Units
Gain	G			30.3		dB
Gain Flatness	G_{FLAT}	$f_{RF} = 2.3GHz$ to 2.7GHz		0.6		dB
Gain Variation Over Temperature	G_{TEMP}	$T_{EPAD} = -40^{\circ}C$ to $+115^{\circ}C$, referenced to $T_{EPAD} = 25^{\circ}C$		+0.7 / -1.0		dB
STBY Mode Gain	G_{STBY}	STBY = logic LOW $P_{IN} \leq -15dBm$ $f_{RF} = 2.3GHz$ to 2.7GHz		-46		dB
RF Input Return Loss	RL_{RFIN}	$f_{RF} = 2.3GHz$ to 2.7GHz		11.9		dB
RF Output Return Loss	RL_{RFOUT}	$f_{RF} = 2.3GHz$ to 2.7GHz		10.6		dB
Reverse Isolation	ISO_{REV}			49		dB
Noise Figure	NF			1.6		dB
Output Third Order Intercept Point	OIP3	$P_{OUT} = +2dBm$ / tone 1MHz tone separation		35.7		dBm
Output 1dB Compression Point	OP1dB			23.6		dBm

Electrical Characteristics – Band 3p5 (3.3GHz to 3.8GHz) / Low Power Mode

See Typical Application Circuit. Specifications apply when operated as a TX amplifier with tuning optimized for the 3.3GHz to 3.8GHz band, $V_{CC} = +5.0V$, $I_{CC} = 100mA^{[a]}$, $R_3 = 16k\Omega$, $f_{RF} = 3.55GHz$, $T_{EPAD} = +25^\circ C$, $STBY = HIGH$, $Z_S = Z_L = 50\Omega$, Evaluation Kit trace and connector losses are de-embedded, unless otherwise stated.

Table 9. Electrical Characteristics – Band 3p5 (3.3GHz to 3.8GHz) / Low Power Mode

Parameter	Symbol	Condition	Minimum	Typical	Maximum	Units
Gain	G		27.9^[a]	28.9		dB
Gain Flatness	G_{FLAT}	$f_{RF} = 3.3GHz$ to 3.8GHz		0.6		dB
Gain Variation Over Temperature	G_{TEMP}	$T_{EPAD} = -40^\circ C$ to $+115^\circ C$, referenced to $T_{EPAD} = 25^\circ C$		+1.2 / -1.5		dB
STBY Mode Gain	G_{STBY}	STBY = logic LOW $P_{IN} \leq -15dBm$ $f_{RF} = 3.3GHz$ to 3.8GHz		-40		dB
RF Input Return Loss	RL_{RFIN}	$f_{RF} = 3.3GHz$ to 3.8GHz		12.8		dB
RF Output Return Loss	RL_{RFOUT}	$f_{RF} = 3.3GHz$ to 3.8GHz		9.6		dB
Reverse Isolation	ISO_{REV}			49		dB
Noise Figure	NF			1.7	2.5	dB
Output Third Order Intercept Point	OIP3	$P_{OUT} = +2dBm$ / tone 1MHz tone separation	31.2	32.3		dBm
		$P_{OUT} = +2dBm$ / tone 1MHz tone separation $V_{CC} = 4.75V$ to 5.25V $T_{EPAD} = -40^\circ C$ to $+115^\circ C$	29.3			
Output 1dB Compression Point	OP1dB		21.2	22.4		dBm
		$V_{CC} = 4.75V$ to 5.25V $T_{EPAD} = -40^\circ C$ to $+115^\circ C$	19.3			

[a] Specifications in the minimum/maximum columns that are shown in **bold italics** are guaranteed by test. Specifications in these columns that are not shown in bold italics are guaranteed by design characterization.

Electrical Characteristics – Band 3p5 (3.3GHz to 3.8GHz) / High Power Mode

See Typical Application Circuit. Specifications apply when operated as a TX amplifier with tuning optimized for the 3.3GHz to 3.8GHz band, $V_{CC} = +5.0V$, $I_{CC} = 140mA$ ^[a], $R_3 = 10k\Omega$, $f_{RF} = 3.55GHz$, $T_{EPAD} = +25^\circ C$, $STBY = HIGH$, $Z_S = Z_L = 50\Omega$, Evaluation Kit trace and connector losses are de-embedded, unless otherwise stated.

Table 10. Electrical Characteristics – Band 3p5 (3.3GHz to 3.8GHz) / High Power Mode

Parameter	Symbol	Condition	Minimum	Typical	Maximum	Units
Gain	G		28.0 ^[a]	29.6		dB
Gain Flatness	G_{FLAT}	$f_{RF} = 3.3GHz$ to 3.8GHz		0.6		dB
Gain Variation Over Temperature	G_{TEMP}	$T_{EPAD} = -40^\circ C$ to $+115^\circ C$, referenced to $T_{EPAD} = 25^\circ C$		+1.2 / -1.5		dB
STBY Mode Gain	G_{STBY}	STBY = logic LOW $P_{IN} \leq -15dBm$ $f_{RF} = 3.3GHz$ to 3.8GHz		-40		dB
RF Input Return Loss	RL_{RFIN}	$f_{RF} = 3.3GHz$ to 3.8GHz		12.5		dB
RF Output Return Loss	RL_{RFOUT}	$f_{RF} = 3.3GHz$ to 3.8GHz		10.5		dB
Reverse Isolation	ISO_{REV}			49		dB
Noise Figure	NF			1.8	2.5	dB
Output Third Order Intercept Point	OIP3	$P_{OUT} = +2dBm$ / tone 1MHz tone separation	35.3	37.0		dBm
		$P_{OUT} = +2dBm$ / tone 1MHz tone separation $V_{CC} = 4.75V$ to 5.25V $T_{EPAD} = -40^\circ C$ to $+115^\circ C$	33.3			
Output 1dB Compression Point	OP1dB		22.5	24.0		dBm
		$V_{CC} = 4.75V$ to 5.25V $T_{EPAD} = -40^\circ C$ to $+115^\circ C$	21.5			

[a] Specifications in the minimum/maximum columns that are shown in **bold italics** are guaranteed by test. Specifications in these columns that are not shown in bold italics are guaranteed by design characterization.

Electrical Characteristics – Band 4p7 (4.4GHz to 5.0GHz) / Low Power Mode

See Typical Application Circuit. Specifications apply when operated as a TX amplifier with tuning optimized for the 4.4GHz to 5.0GHz band, $V_{CC} = +5.0V$, $I_{CC} = 100mA$, $R3 = 16k\Omega$, $f_{RF} = 4.7GHz$, $T_{EPAD} = +25^{\circ}C$, $STBY = HIGH$, $Z_S = Z_L = 50\Omega$, Evaluation Kit trace and connector losses are de-embedded, unless otherwise stated.

Table 11. Electrical Characteristics – Band 4p7 (4.4GHz to 5.0GHz) / Low Power Mode

Parameter	Symbol	Condition	Minimum	Typical	Maximum	Units
Gain	G			27.7		dB
Gain Flatness	G_{FLAT}	$f_{RF} = 4.4GHz$ to $5.0GHz$		1		dB
Gain Variation Over Temperature	G_{TEMP}	$T_{EPAD} = -40^{\circ}C$ to $+115^{\circ}C$, referenced to $T_{EPAD} = 25^{\circ}C$		+0.8 / -1.2		dB
STBY Mode Gain	G_{STBY}	STBY = logic LOW $P_{IN} \leq -15dBm$ $f_{RF} = 4.4GHz$ to $5.0GHz$		-39		dB
RF Input Return Loss	RL_{RFIN}	$f_{RF} = 4.4GHz$ to $5.0GHz$		7.4		dB
RF Output Return Loss	RL_{RFOUT}	$f_{RF} = 4.4GHz$ to $5.0GHz$		10.2		dB
Reverse Isolation	ISO_{REV}			50		dB
Noise Figure	NF			1.9		dB
Output Third Order Intercept Point	OIP3	$P_{OUT} = +2dBm$ / tone 1MHz tone separation		37.0		dBm
Output 1dB Compression Point	OP1dB			24.5		dBm

Electrical Characteristics – Band 4p7 (4.4GHz to 5.0GHz) / High Power Mode

See Typical Application Circuit. Specifications apply when operated as a TX amplifier with tuning optimized for the 4.4GHz to 5.0GHz band, $V_{CC} = +5.0V$, $I_{CC} = 140mA$, $R3 = 10k\Omega$, $f_{RF} = 4.7GHz$, $T_{EPAD} = +25^{\circ}C$, $STBY = HIGH$, $Z_S = Z_L = 50\Omega$, Evaluation Kit trace and connector losses are de-embedded, unless otherwise stated.

Table 12. Electrical Characteristics – Band 4p7 (4.4GHz to 5.0GHz) / High Power Mode

Parameter	Symbol	Condition	Minimum	Typical	Maximum	Units
Gain	G			28.6		dB
Gain Flatness	G_{FLAT}	$f_{RF} = 4.4GHz$ to $5.0GHz$		1		dB
Gain Variation Over Temperature	G_{TEMP}	$T_{EPAD} = -40^{\circ}C$ to $+115^{\circ}C$, referenced to $T_{EPAD} = 25^{\circ}C$		+0.8 / -1.2		dB
STBY Mode Gain	G_{STBY}	STBY = logic LOW $P_{IN} \leq -15dBm$ $f_{RF} = 4.4GHz$ to $5.0GHz$		-39		dB
RF Input Return Loss	RL_{RFIN}	$f_{RF} = 4.4GHz$ to $5.0GHz$		8.2		dB
RF Output Return Loss	RL_{RFOUT}	$f_{RF} = 4.4GHz$ to $5.0GHz$		11		dB
Reverse Isolation	ISO_{REV}			50		dB
Noise Figure	NF			1.9		dB
Output Third Order Intercept Point	OIP3	$P_{OUT} = +2dBm$ / tone 1MHz tone separation		42.1		dBm
Output 1dB Compression Point	OP1dB			25.1		dBm

Thermal Characteristics

Table 13. Package Thermal Characteristics

Parameter	Symbol	Value	Units
Junction to Ambient Thermal Resistance	θ_{JA}	67.9	°C/W
Junction to Case Thermal Resistance. (Case is defined as the exposed paddle)	θ_{JC_BOT}	22.9	°C/W
Moisture Sensitivity Rating (Per J-STD-020)		MSL 3	

Typical Operating Conditions

Unless otherwise stated the typical operating graphs were measured under the following conditions:

- $V_{CC} = 5.0V$
- $Z_S = Z_L = 50\Omega$ Single Ended
- $I_{CC} = 100mA$ or $140mA$
- $f_{RF} = 2.0GHz$ (Band 2p0)
- $f_{RF} = 2.5GHz$ (Band 2p5)
- $f_{RF} = 3.55GHz$ (Band 3p5)
- $f_{RF} = 4.7GHz$ (Band 4p7)
- $T_{EPAD} = +25^{\circ}C$
- STBY = HIGH
- 1MHz Tone Spacing
- All temperatures are referenced to the exposed paddle

Typical Performance Characteristics (Band 2p0 – 1.8GHz to 2.2GHz)

Figure 3. Gain - Low Power Mode

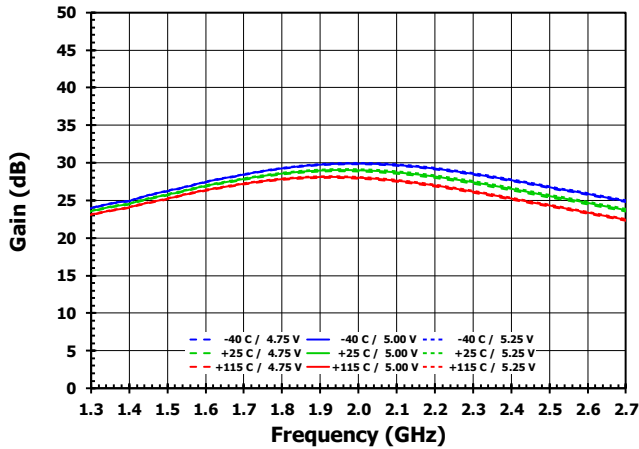

Figure 4. Gain - High Power Mode

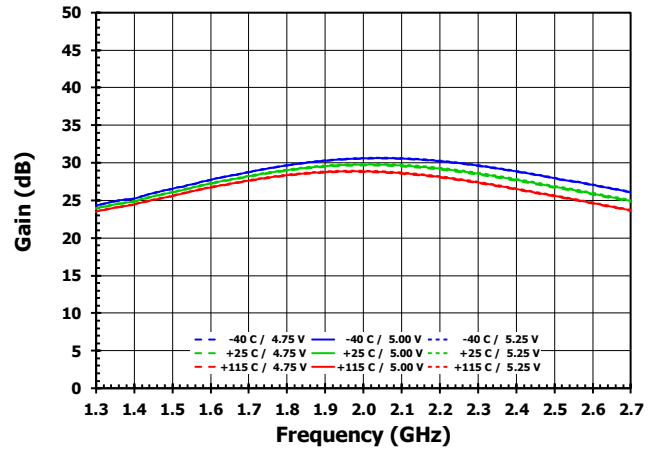

Figure 5. Input Return Loss - Low Power Mode

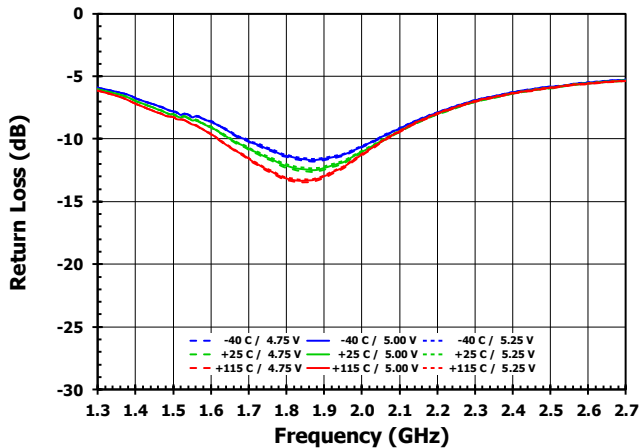

Figure 6. Input Return Loss - High Power Mode

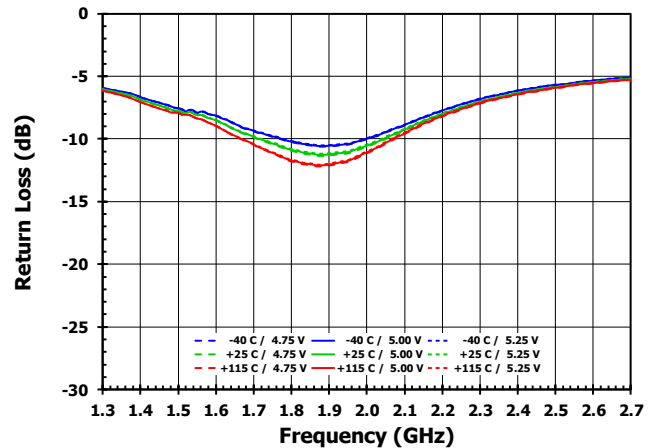

Figure 7. Output Return Loss - Low Power Mode

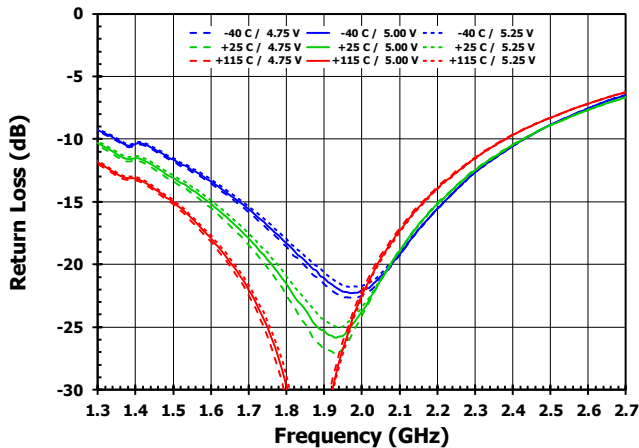
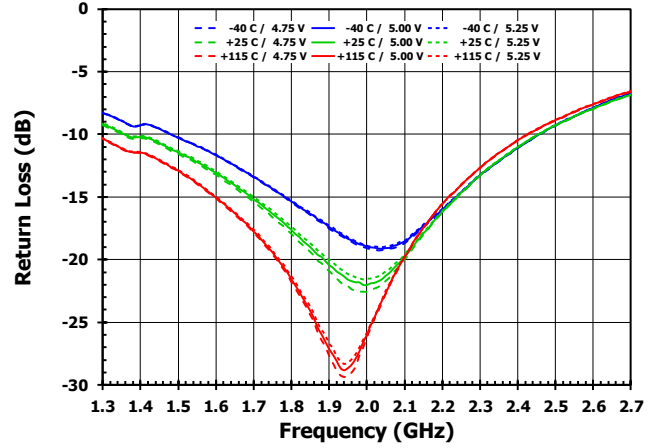

Figure 8. Output Return Loss - High Power Mode



Typical Performance Characteristics (Band 2p0 – 1.8GHz to 2.2GHz)

Figure 9. Gain - Low Power Mode, Broadband

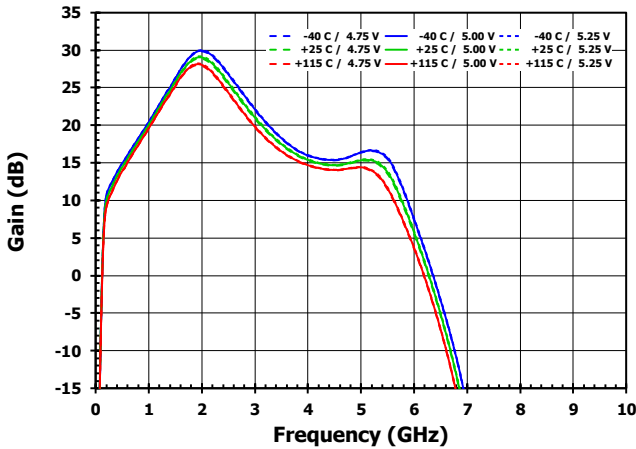

Figure 10. Gain - High Power Mode, Broadband

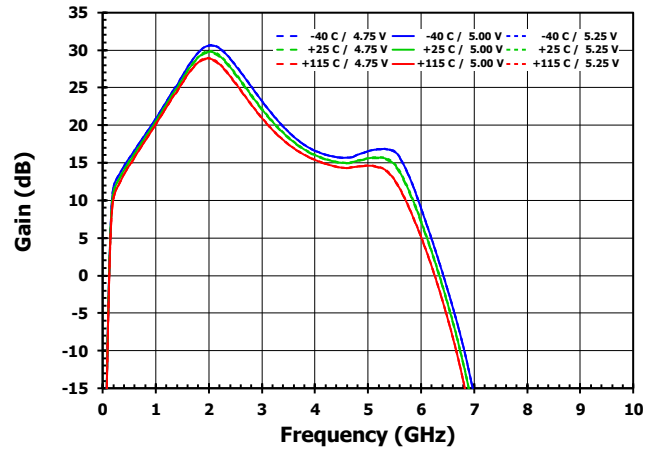

Figure 11. Input Return Loss - Low Power Mode, Broadband

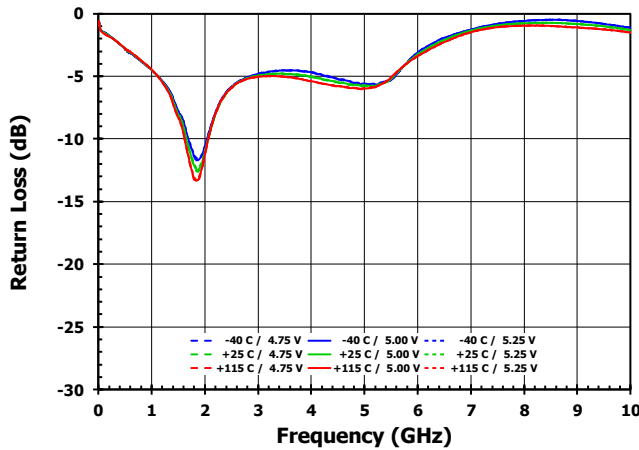

Figure 12. Input Return Loss - High Power Mode, Broadband

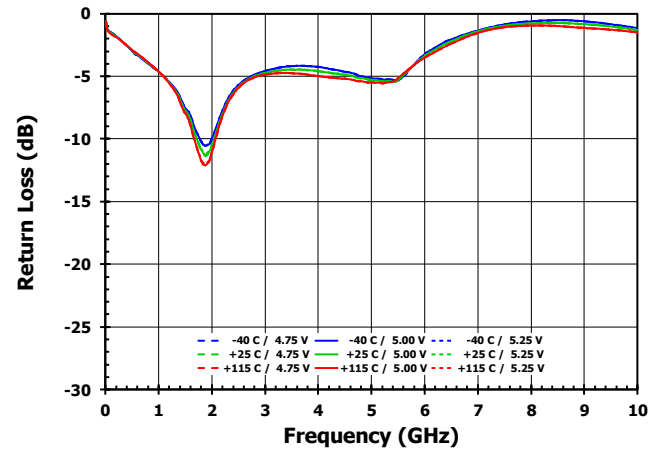

Figure 13. Output Return Loss - Low Power Mode, Broadband

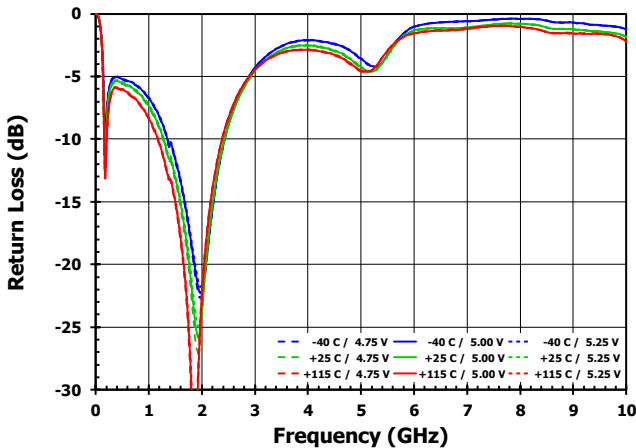
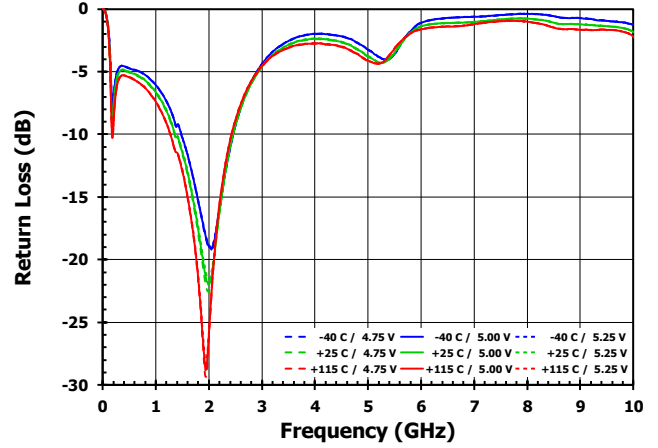

Figure 14. Output Return Loss - High Power Mode, Broadband



Typical Performance Characteristics (Band 2p0 – 1.8GHz to 2.2GHz)

Figure 15. Reverse Isolation - Low Power Mode

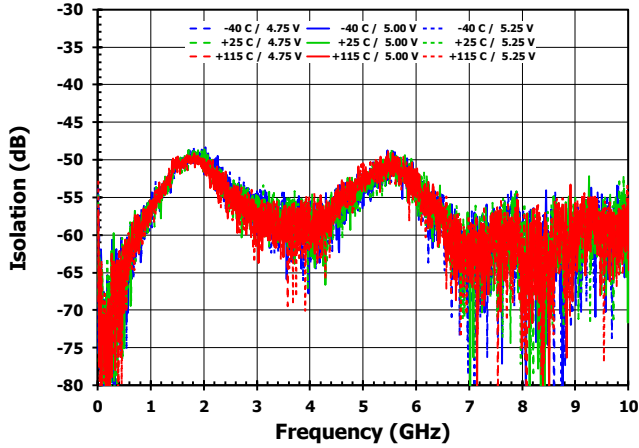

Figure 16. Reverse Isolation - High Power Mode

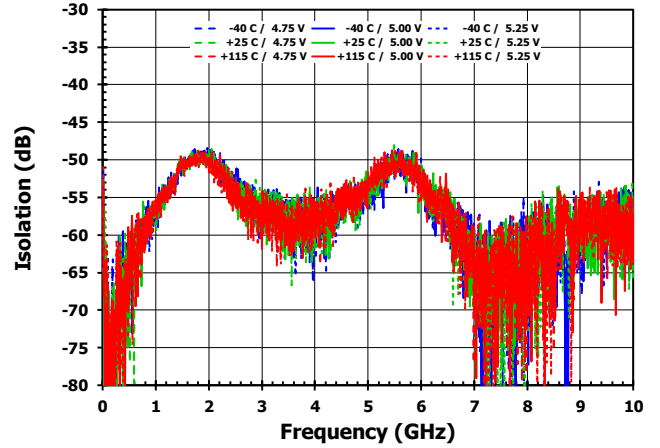

Figure 17. Standby Mode Gain

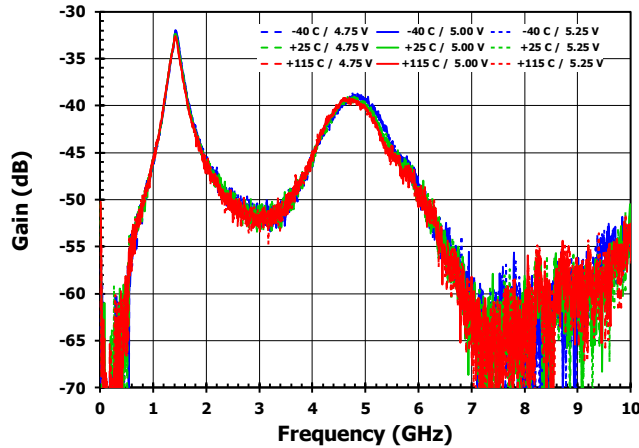

Figure 18. Current versus Power Supply Voltage

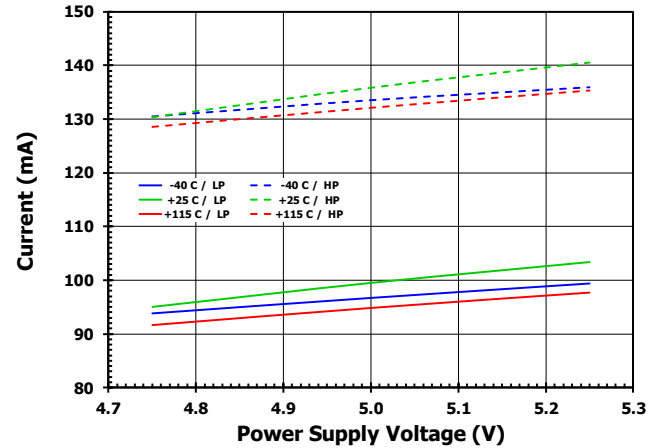

Figure 19. Standby Mode Reverse Isolation

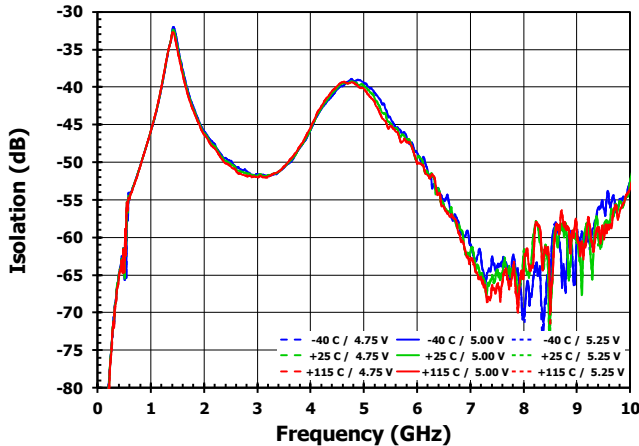
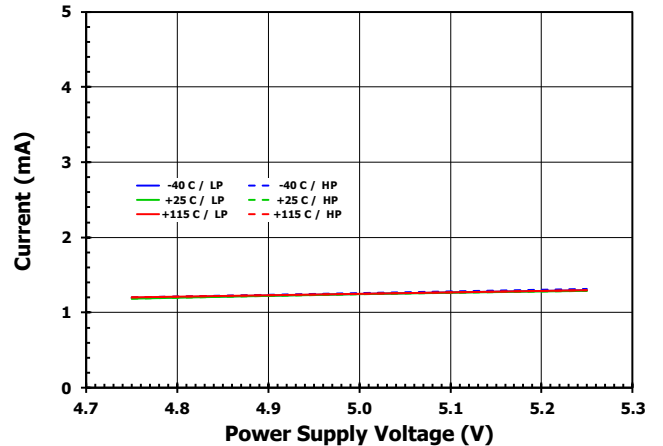

Figure 20. Standby Current versus Power Supply Voltage



Typical Performance Characteristics (Band 2p0 – 1.8GHz to 2.2GHz)

Figure 21. Output IP3 - Low Power Mode

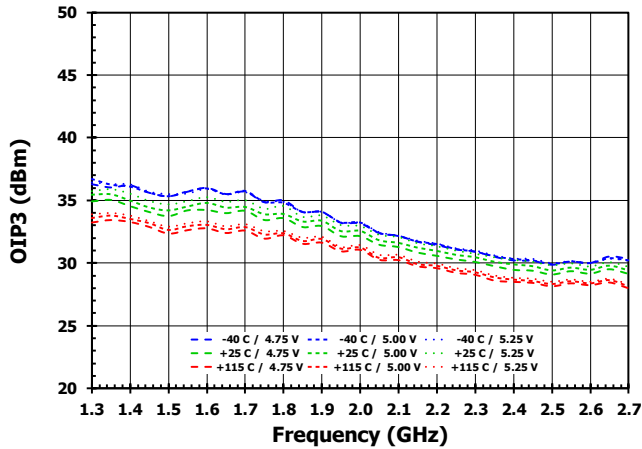

Figure 22. Output IP3 - High Power Mode

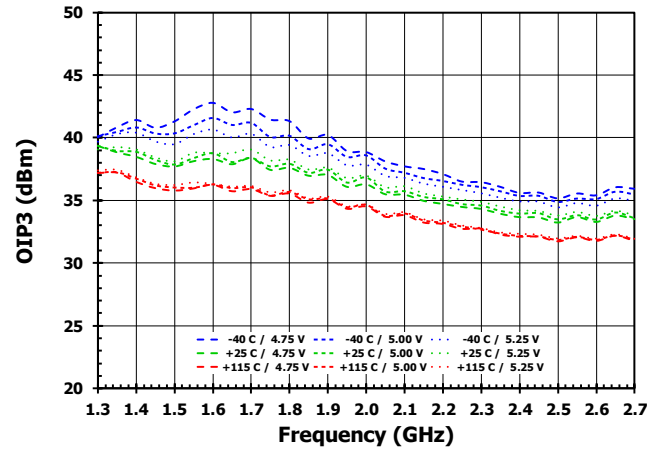

Figure 23. Output Compression - Low Power Mode

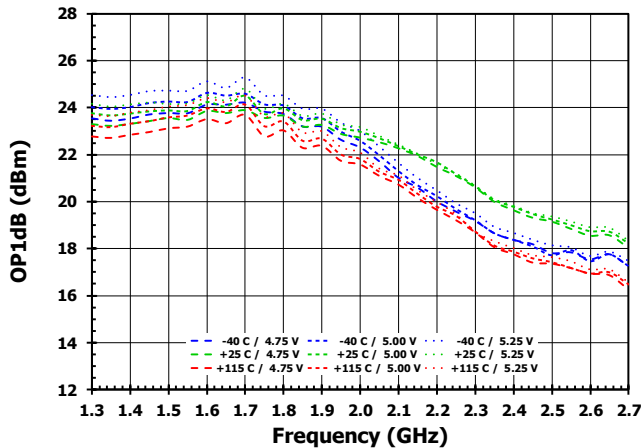

Figure 24. Output Compression - High Power Mode

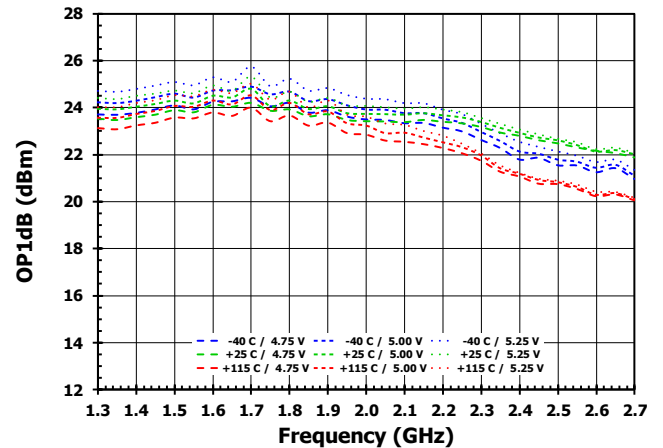

Figure 25. Noise Figure - Low Power Mode

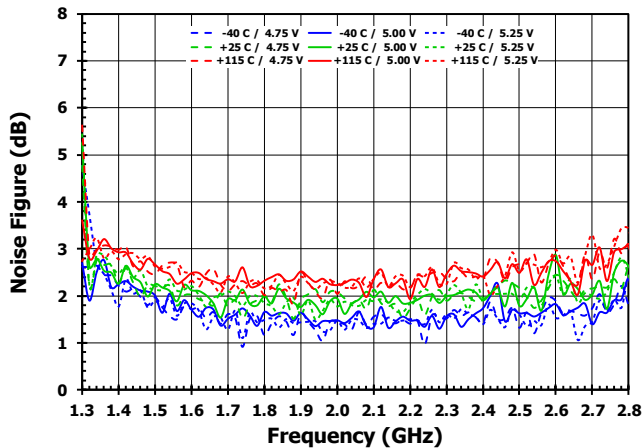
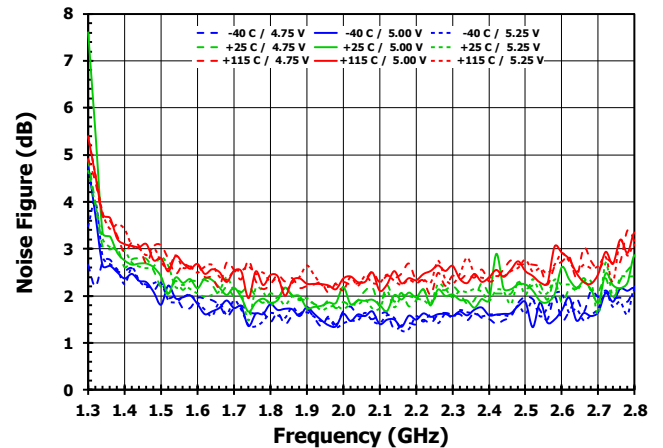

Figure 26. Noise Figure - High Power Mode



Typical Performance Characteristics (Band 2p5 – 2.3GHz to 2.7GHz)

Figure 27. Gain - Low Power Mode

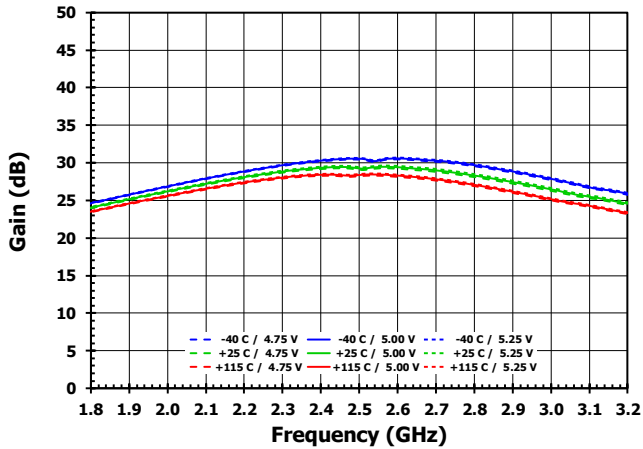

Figure 28. Gain - High Power Mode

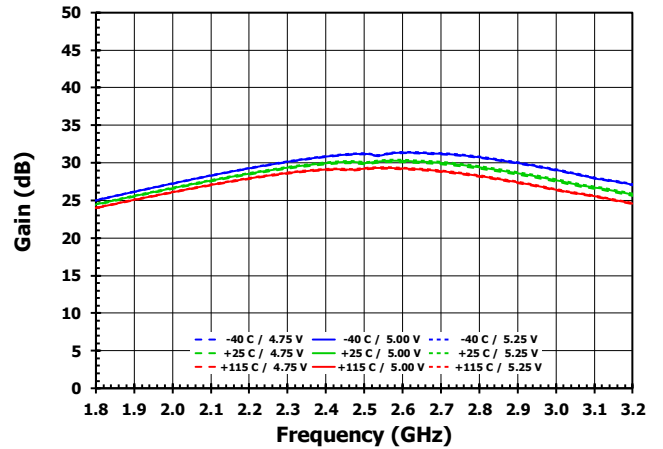

Figure 29. Input Return Loss - Low Power Mode

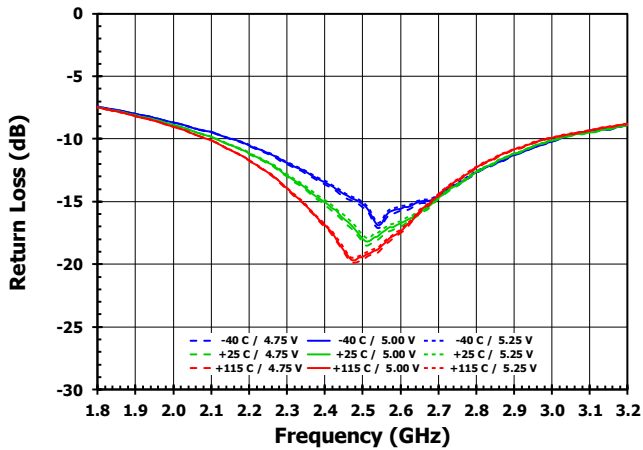

Figure 30. Input Return Loss - High Power Mode

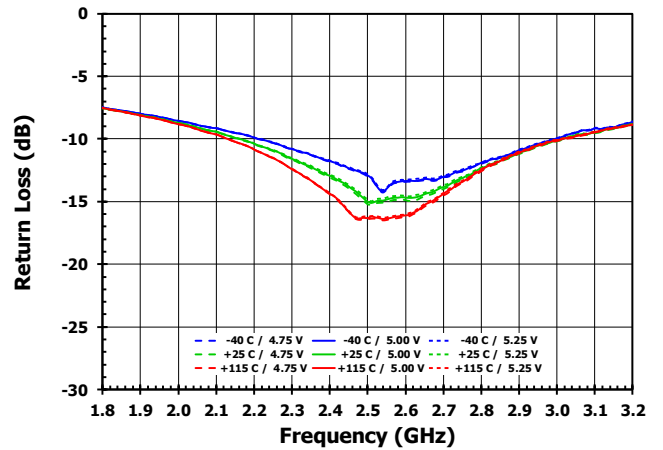

Figure 31. Output Return Loss - Low Power Mode

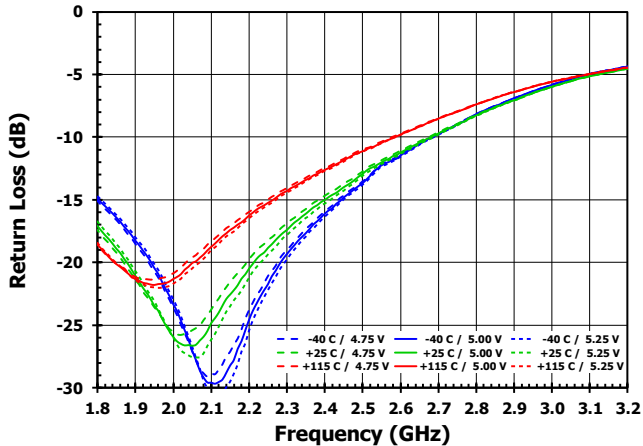
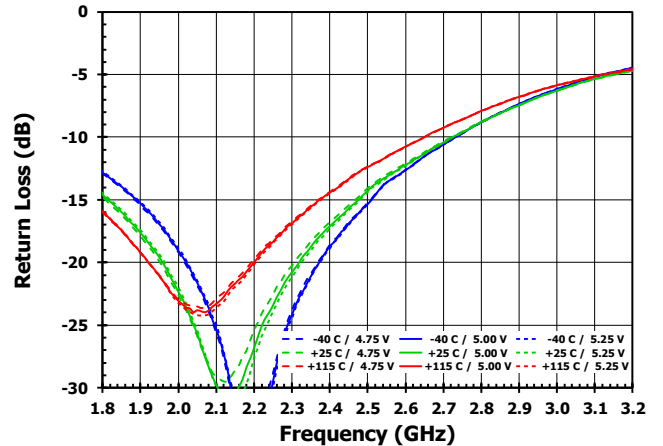

Figure 32. Output Return Loss - High Power Mode



Typical Performance Characteristics (Band 2p5 – 2.3GHz to 2.7GHz)

Figure 33. Gain - Low Power Mode, Broadband

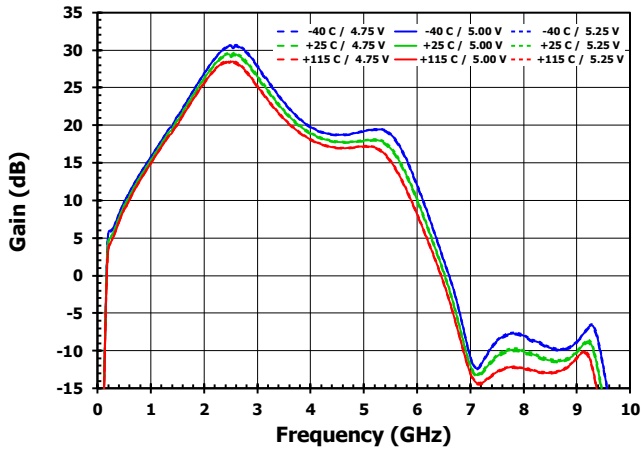

Figure 34. Gain - High Power Mode, Broadband

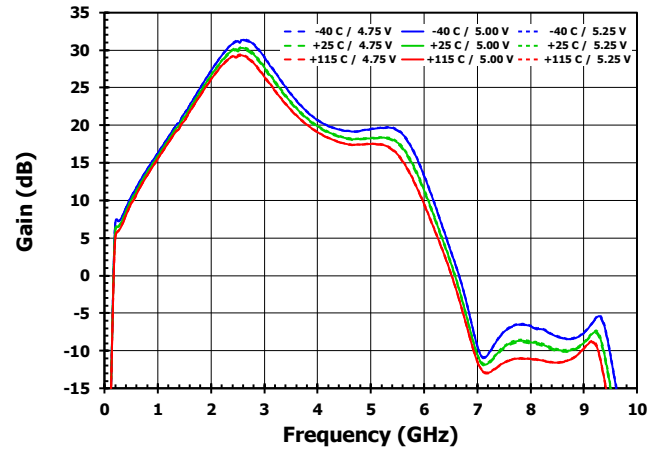

Figure 35. Input Return Loss - Low Power Mode, Broadband

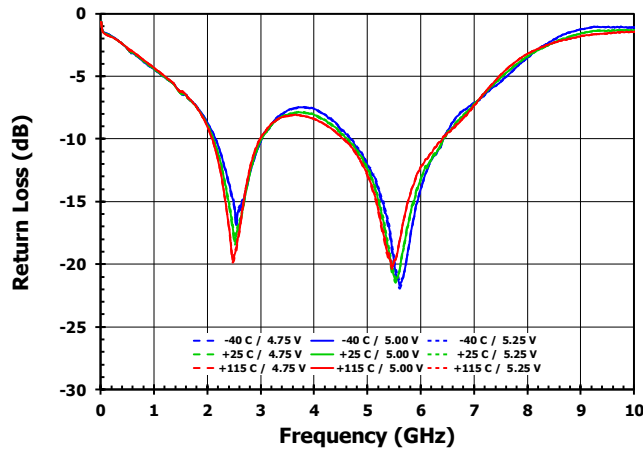

Figure 36. Input Return Loss - High Power Mode, Broadband

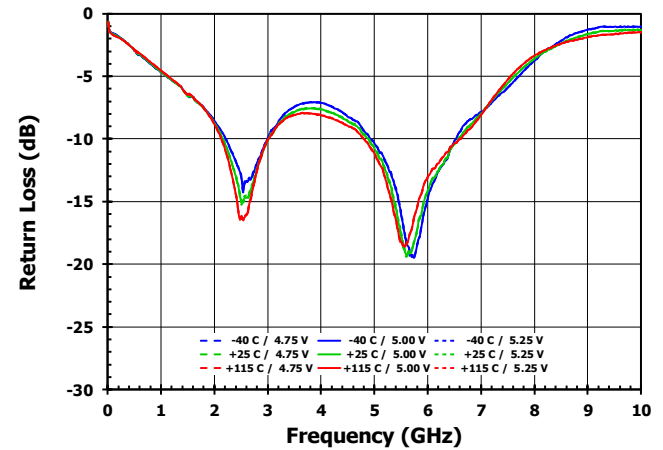

Figure 37. Output Return Loss - Low Power Mode, Broadband

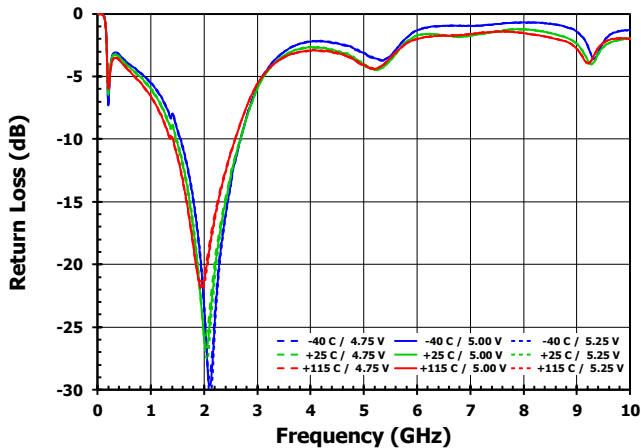
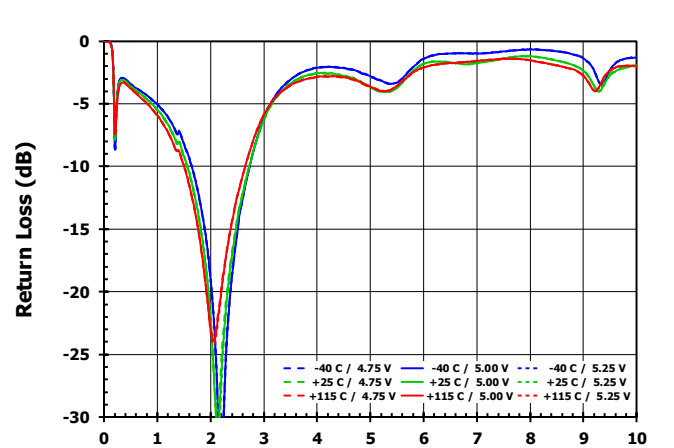

Figure 38. Output Return Loss - High Power Mode, Broadband



Typical Performance Characteristics (Band 2p5 – 2.3GHz to 2.7GHz)

Figure 39. Reverse Isolation - Low Power Mode

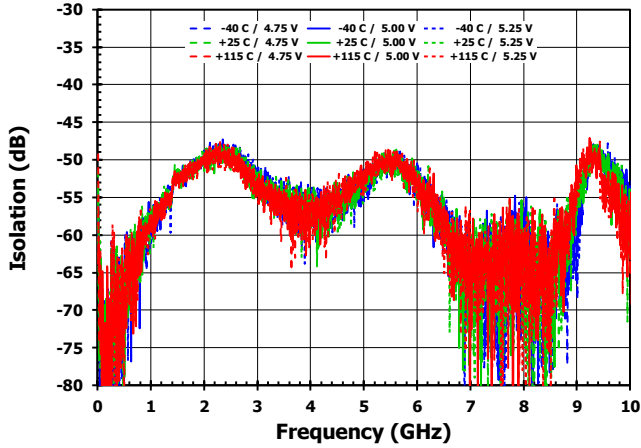

Figure 40. Reverse Isolation - High Power Mode

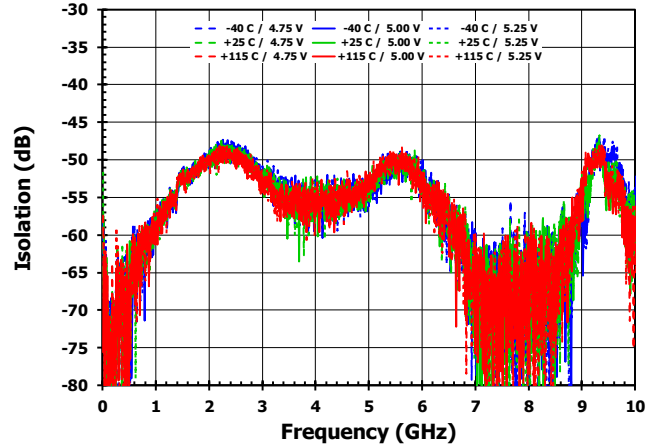

Figure 41. Standby Mode Gain

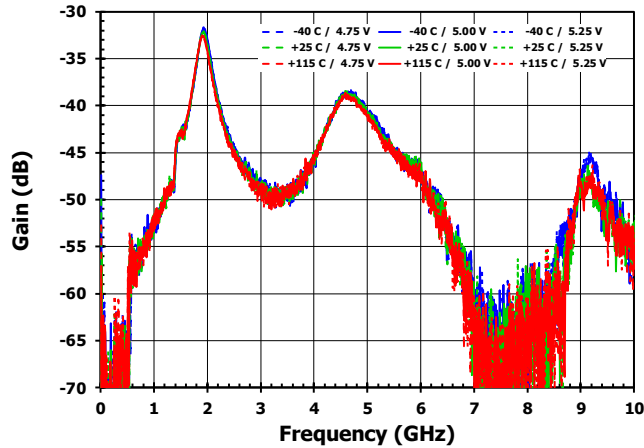

Figure 42. Current versus Power Supply Voltage

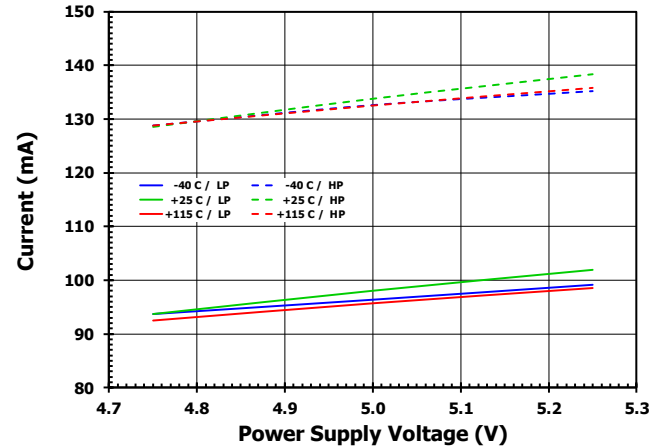

Figure 43. Standby Mode Reverse Isolation

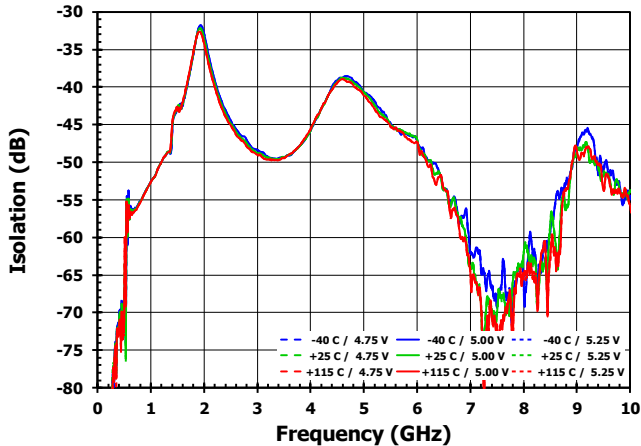
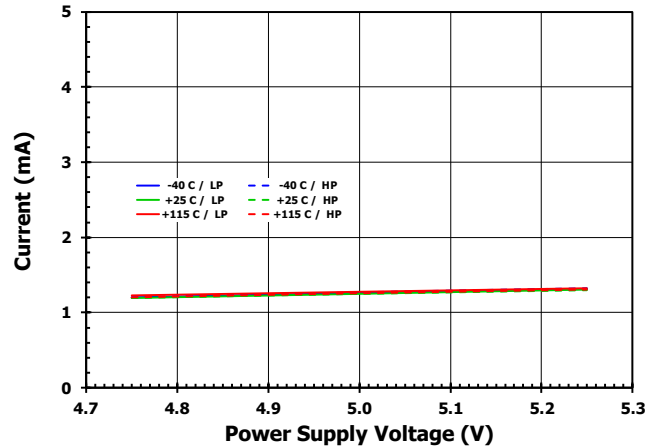

Figure 44. Standby Current versus Power Supply Voltage



Typical Performance Characteristics (Band 2p5 – 2.3GHz to 2.7GHz)

Figure 45. Output IP3 - Low Power Mode

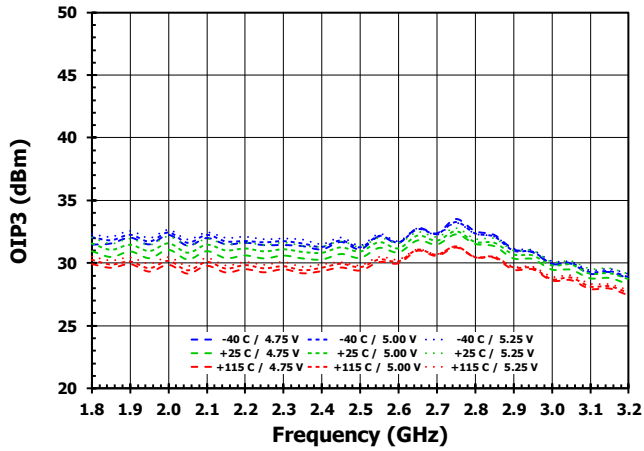

Figure 46. Output IP3 - High Power Mode

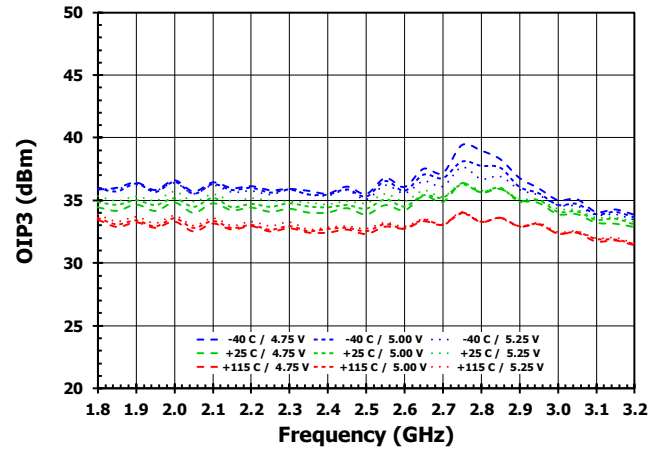

Figure 47. Output Compression - Low Power Mode

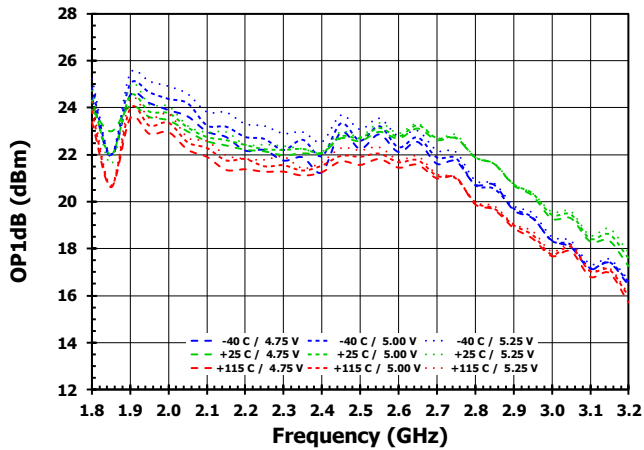

Figure 48. Output Compression - High Power Mode

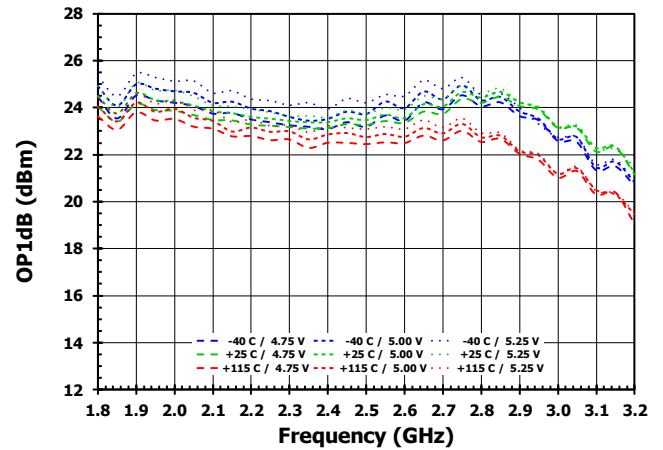

Figure 49. Noise Figure - Low Power Mode

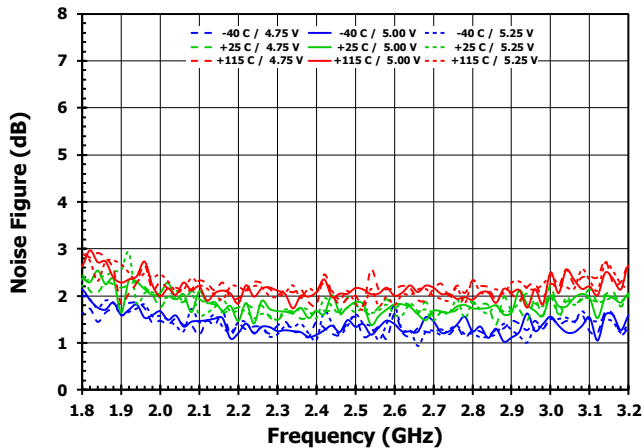
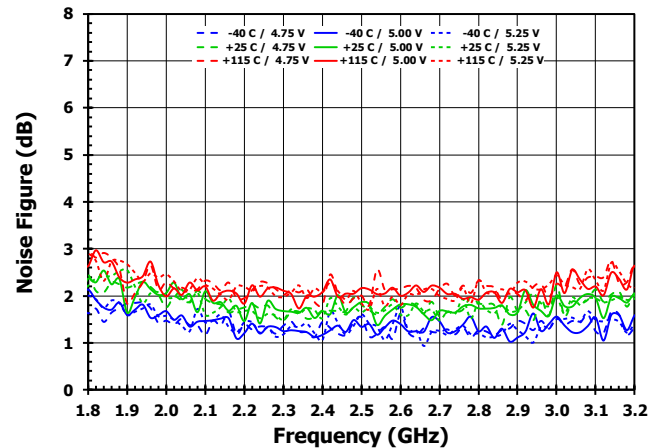

Figure 50. Noise Figure - High Power Mode



Typical Performance Characteristics (Band 3p5 – 3.3GHz to 3.8GHz)

Figure 51. Gain - Low Power Mode

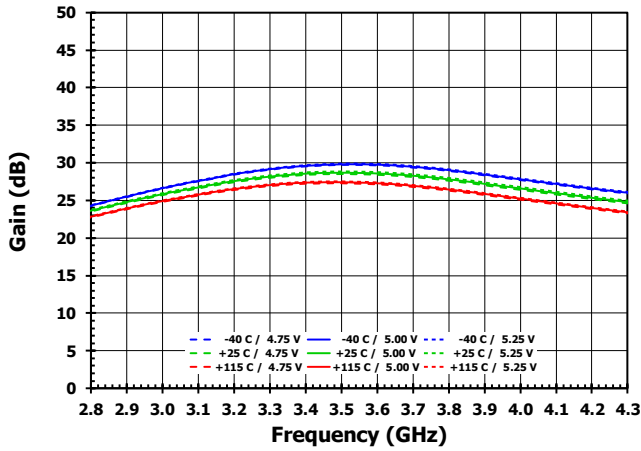

Figure 52. Gain - High Power Mode

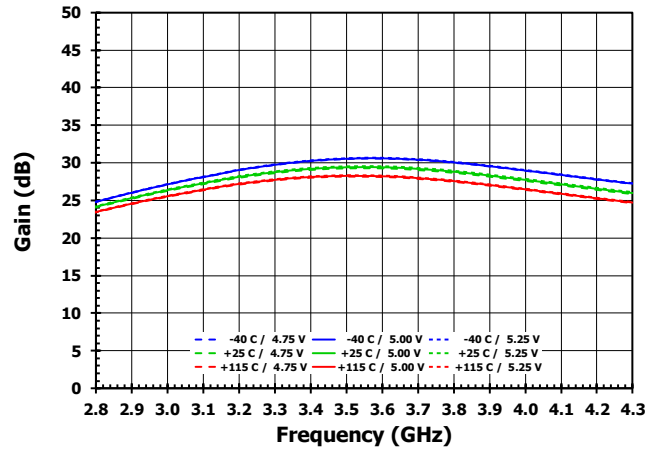

Figure 53. Input Return Loss - Low Power Mode

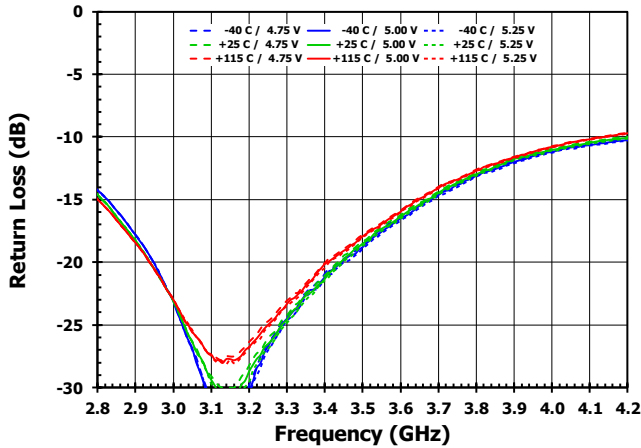

Figure 54. Input Return Loss - High Power Mode

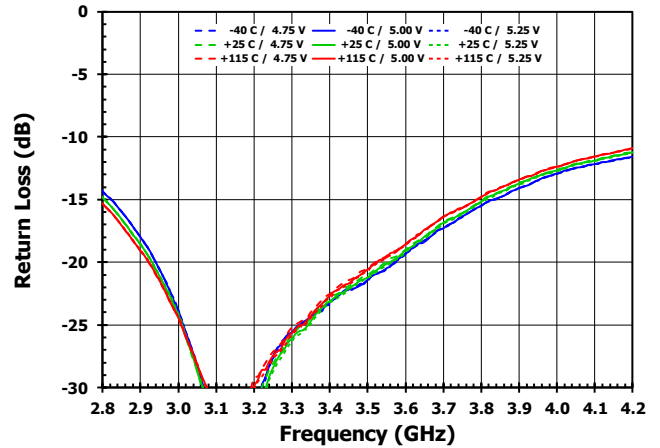

Figure 55. Output Return Loss - Low Power Mode

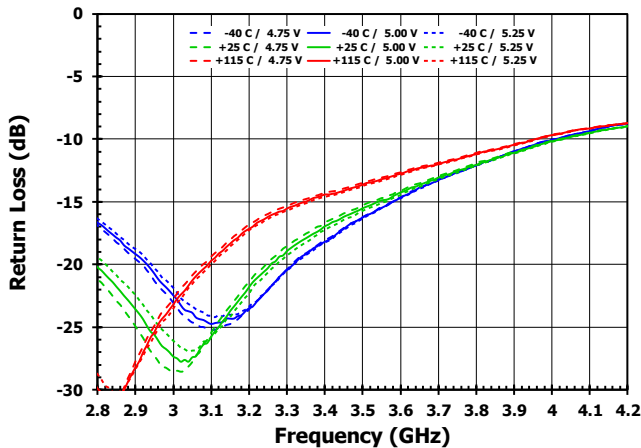
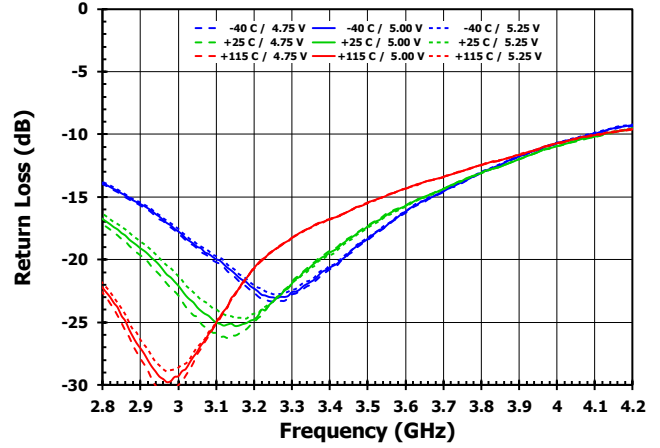

Figure 56. Output Return Loss - High Power Mode



Typical Performance Characteristics (Band 3p5 – 3.3GHz to 3.8GHz)

Figure 57. Gain - Low Power Mode, Broadband

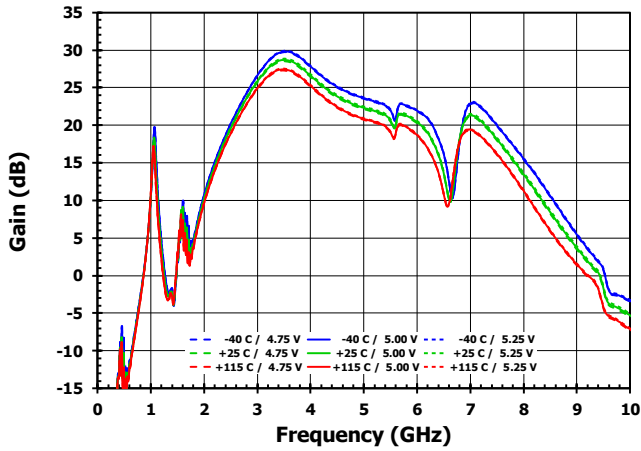

Figure 58. Gain - High Power Mode, Broadband

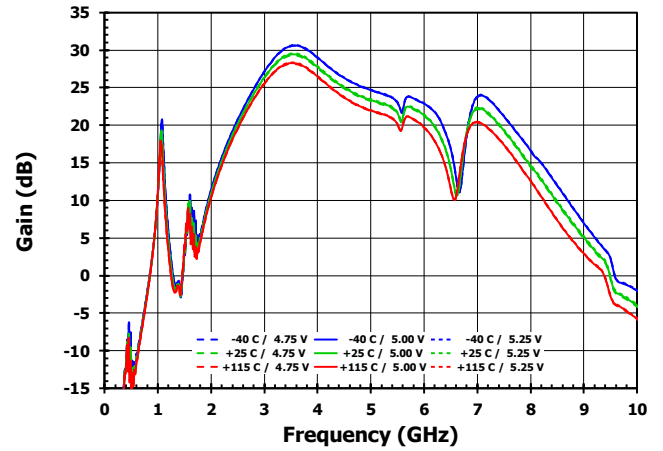

Figure 59. Input Return Loss - Low Power Mode, Broadband

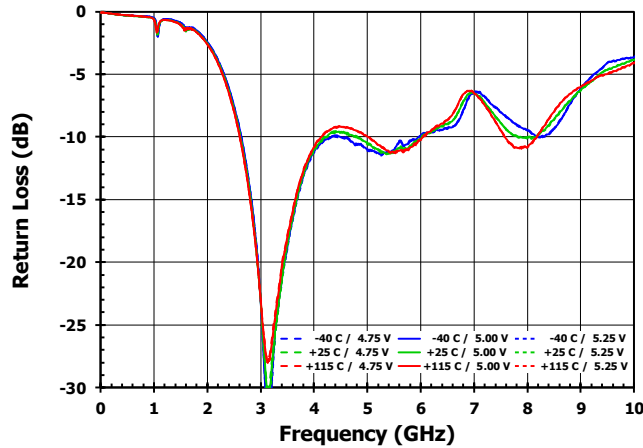

Figure 60. Input Return Loss - High Power Mode, Broadband

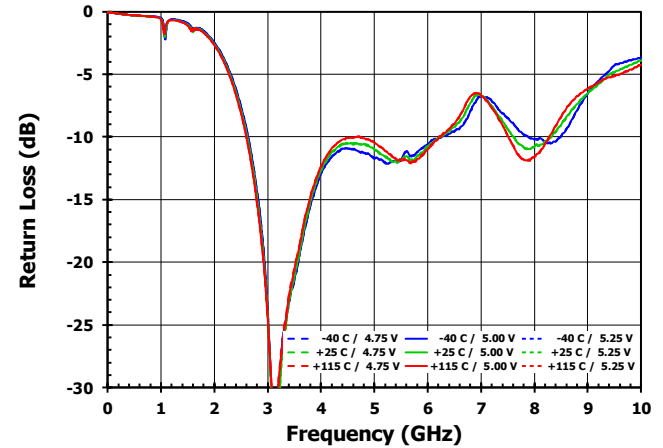

Figure 61. Output Return Loss - Low Power Mode, Broadband

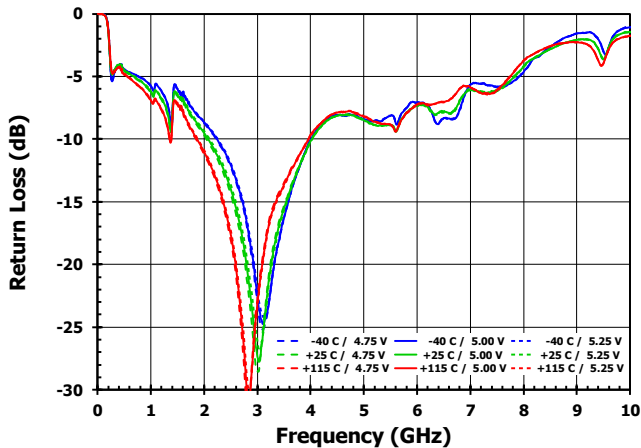
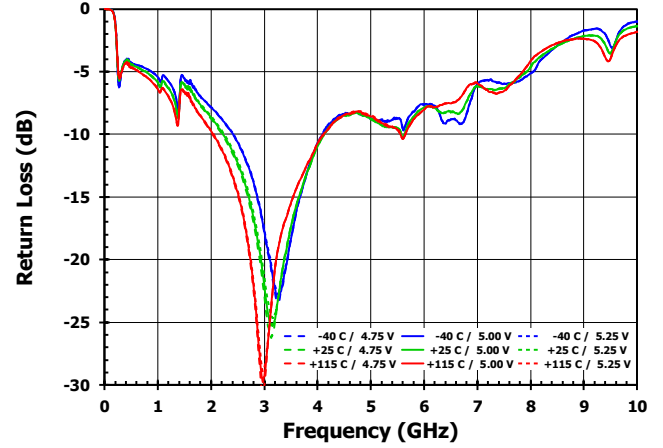

Figure 62. Output Return Loss - High Power Mode, Broadband



Typical Performance Characteristics (Band 3p5 – 3.3GHz to 3.8GHz)

Figure 63. Reverse Isolation - Low Power Mode

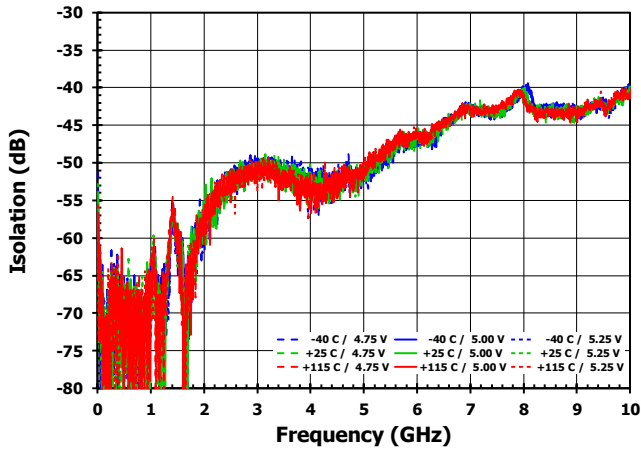

Figure 64. Reverse Isolation - High Power Mode

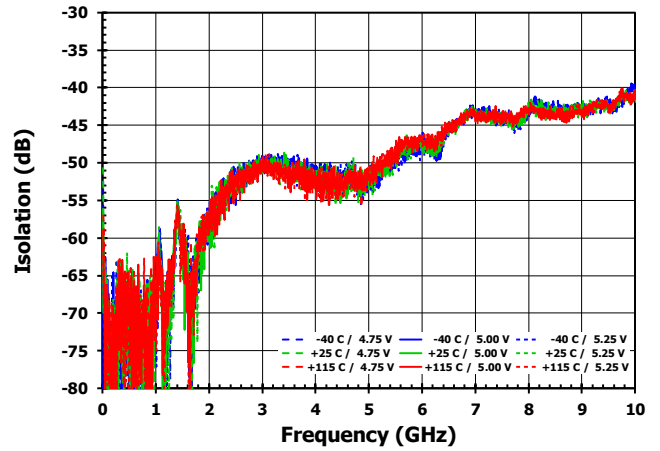

Figure 65. Standby Mode Gain versus Frequency

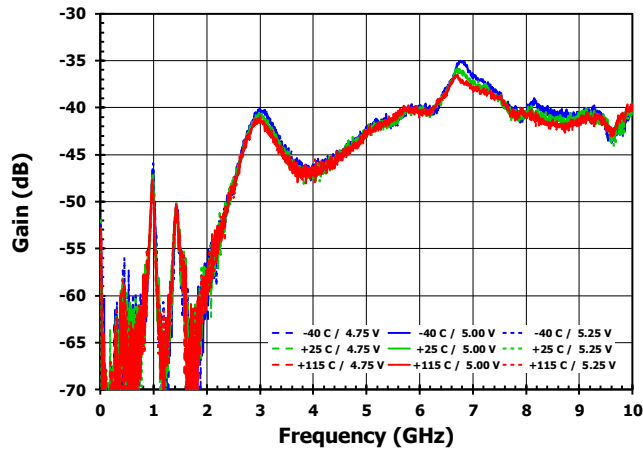

Figure 66. Current versus Power Supply Voltage

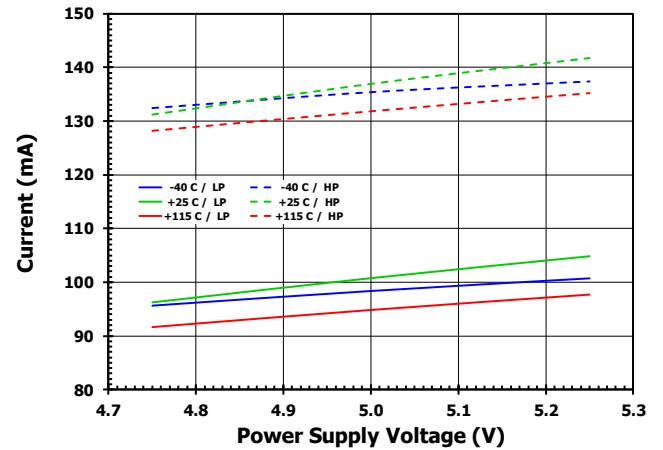

Figure 67. Standby Mode Reverse Isolation

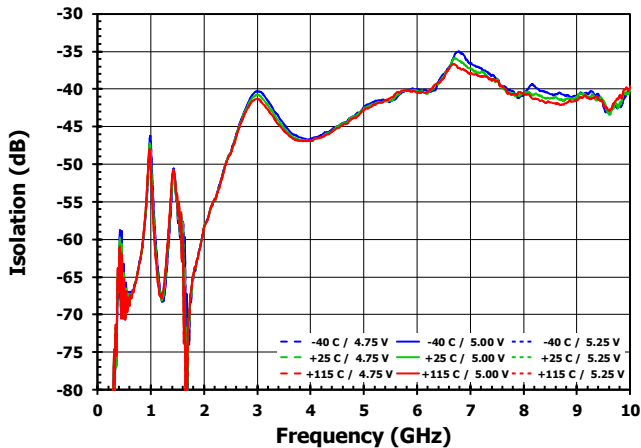
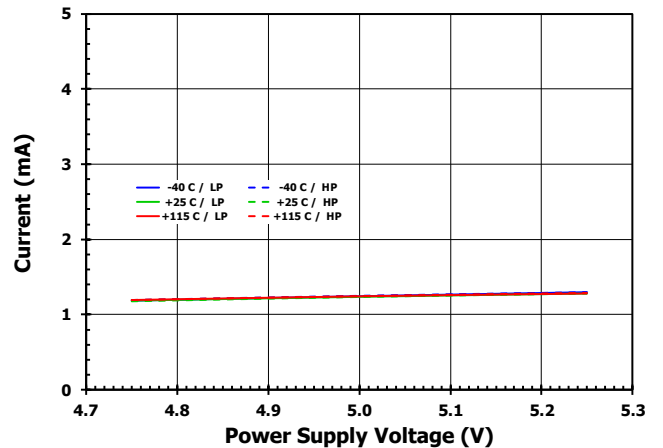

Figure 68. Standby Current versus Power Supply Voltage



Typical Performance Characteristics (Band 3p5 – 3.3GHz to 3.8GHz)

Figure 69. Output IP3 - Low Power Mode

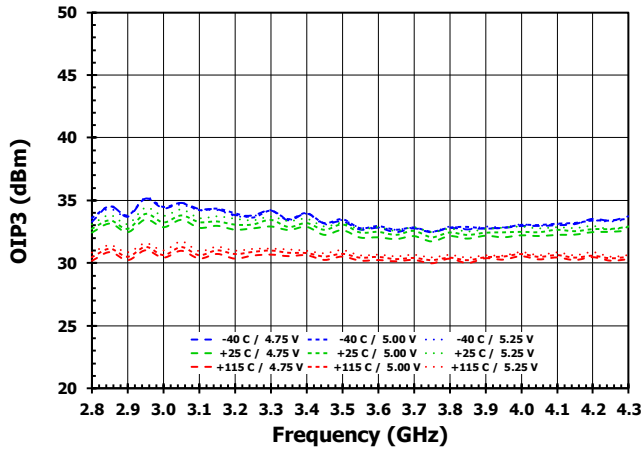

Figure 70. Output IP3 - High Power Mode

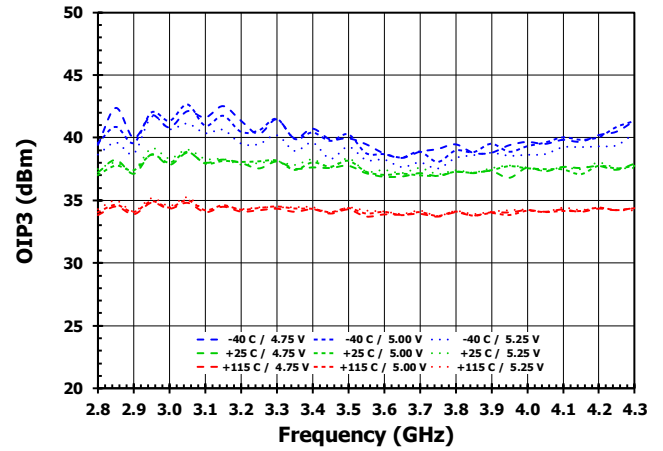

Figure 71. Output Compression - Low Power Mode

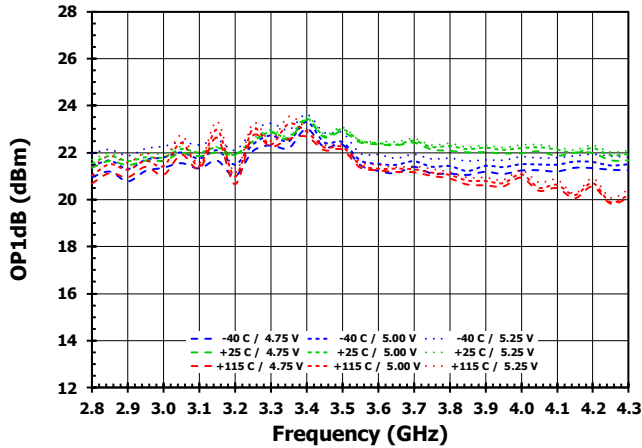

Figure 72. Output Compression - High Power Mode

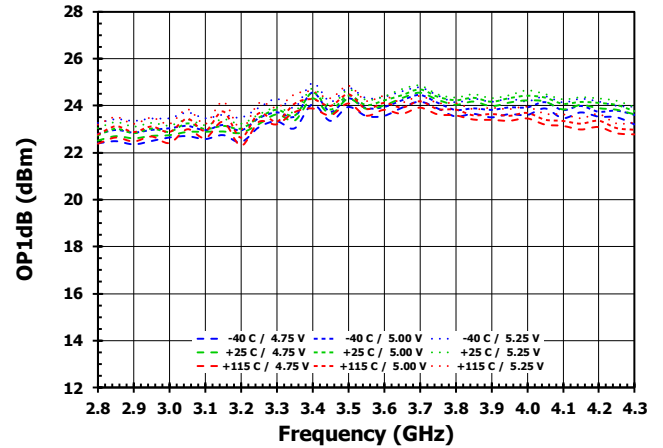

Figure 73. Noise Figure - Low Power Mode

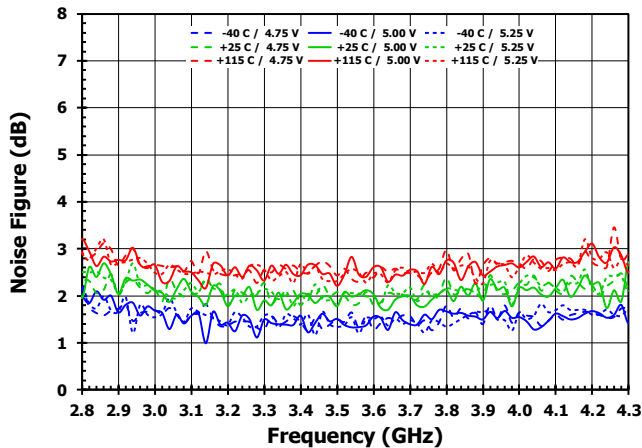
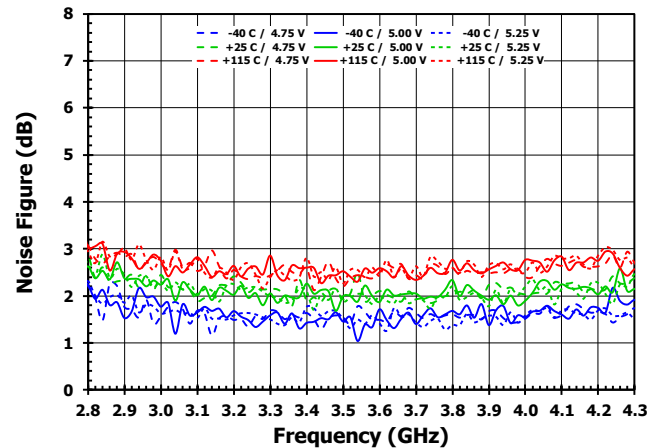

Figure 74. Noise Figure - High Power Mode



Typical Performance Characteristics (Band 4p7 – 4.4GHz to 5.0GHz)

Figure 75. Gain - Low Power Mode

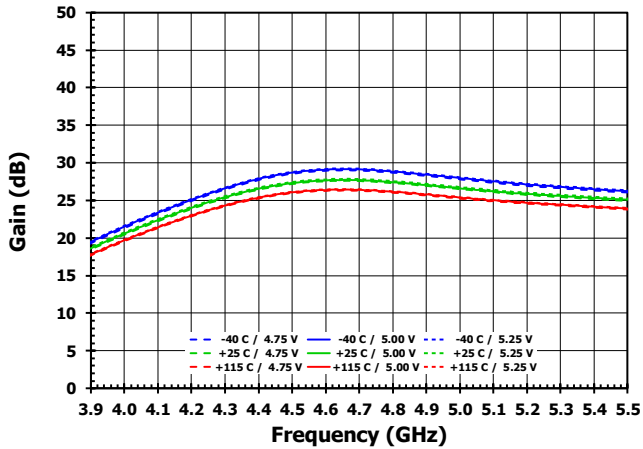

Figure 76. Gain - High Power Mode

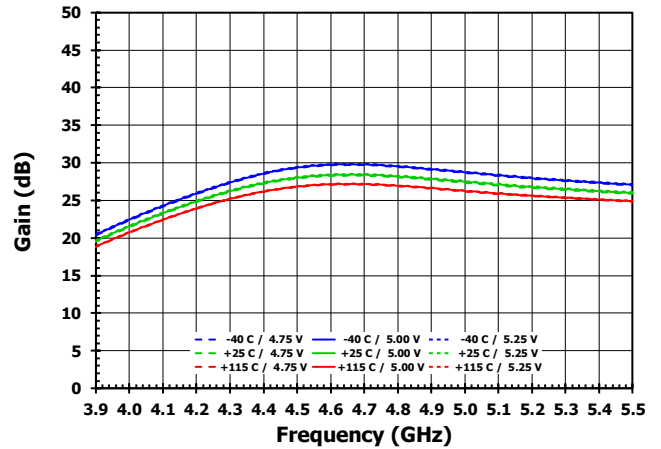

Figure 77. Input Return Loss - Low Power Mode

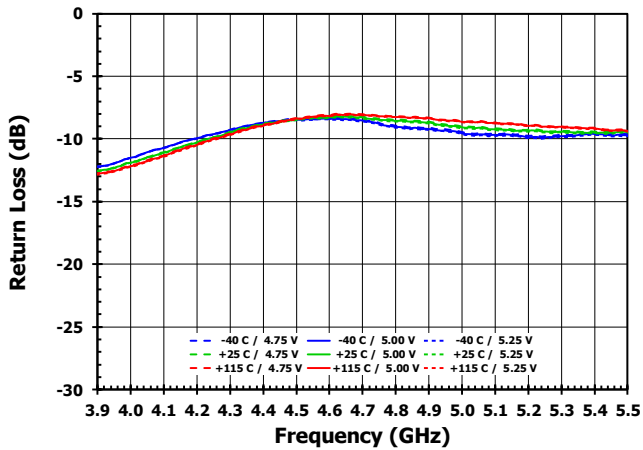

Figure 78. Input Return Loss - High Power Mode

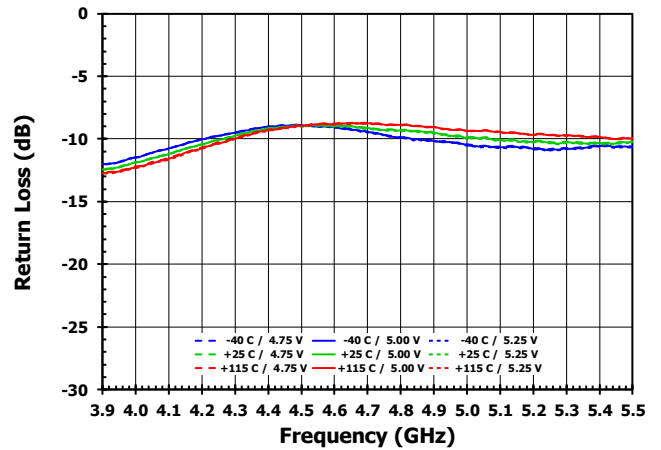

Figure 79. Output Return Loss - Low Power Mode

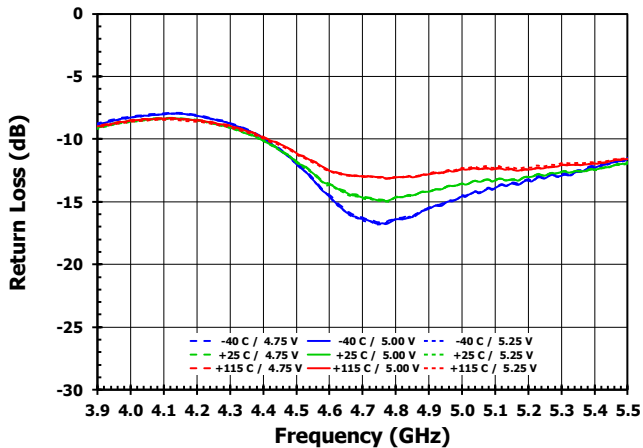
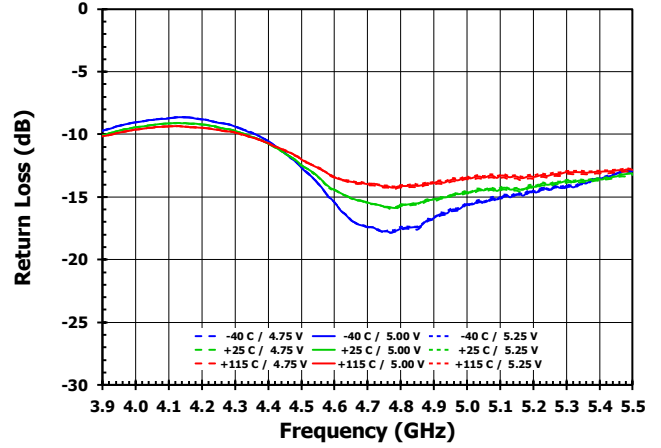

Figure 80. Output Return Loss - High Power Mode



Typical Performance Characteristics (Band 4p7 – 4.4GHz to 5.0GHz)

Figure 81. Gain - Low Power Mode, Broadband

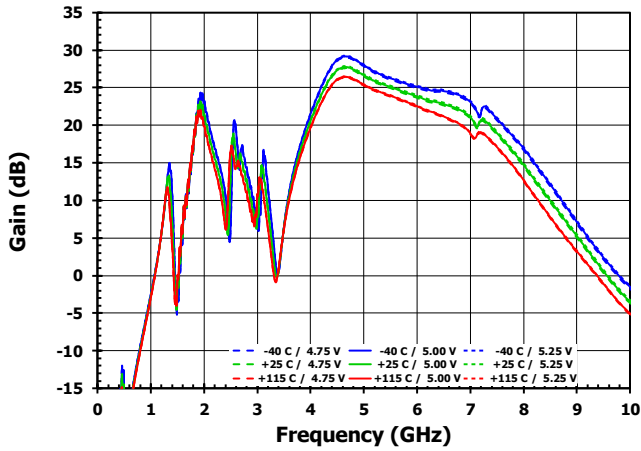

Figure 82. Gain - High Power Mode, Broadband

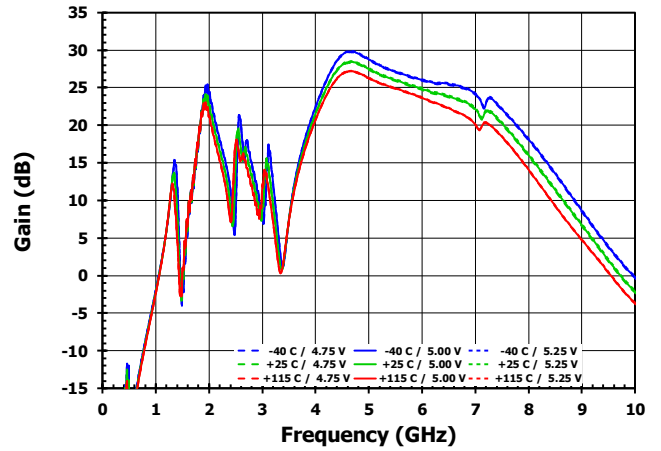

Figure 83. Input Return Loss - Low Power Mode, Broadband

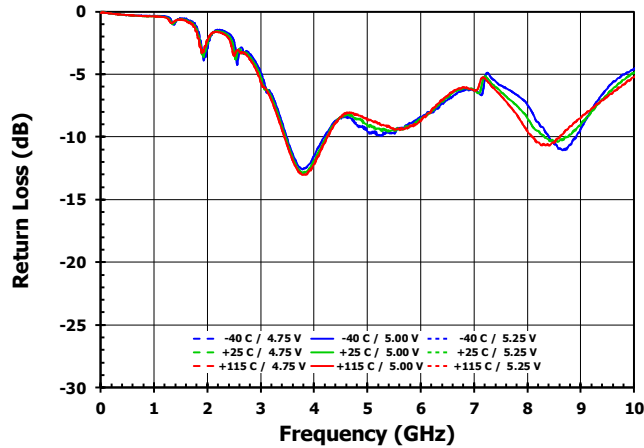

Figure 84. Input Return Loss - High Power Mode, Broadband

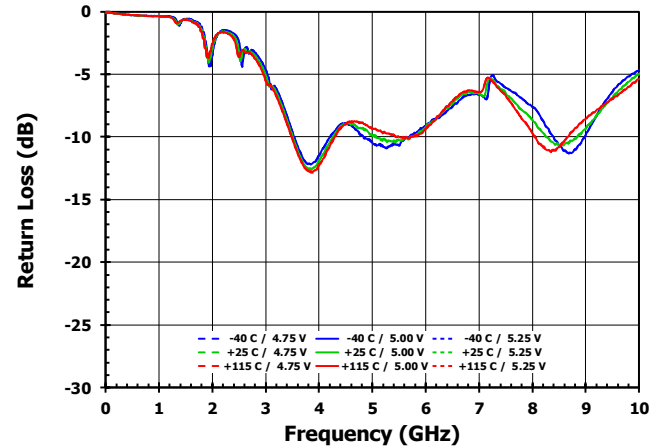

Figure 85. Output Return Loss - Low Power Mode, Broadband

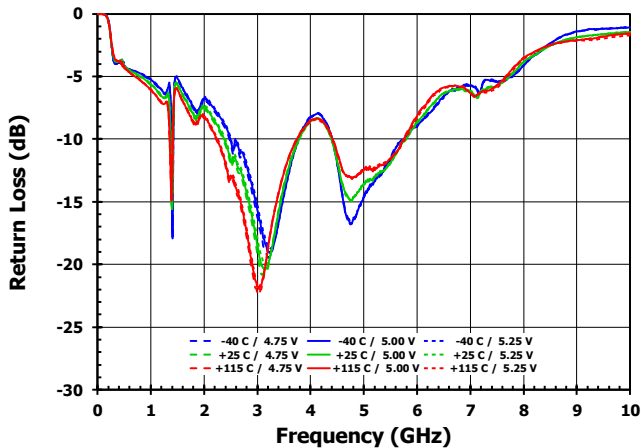
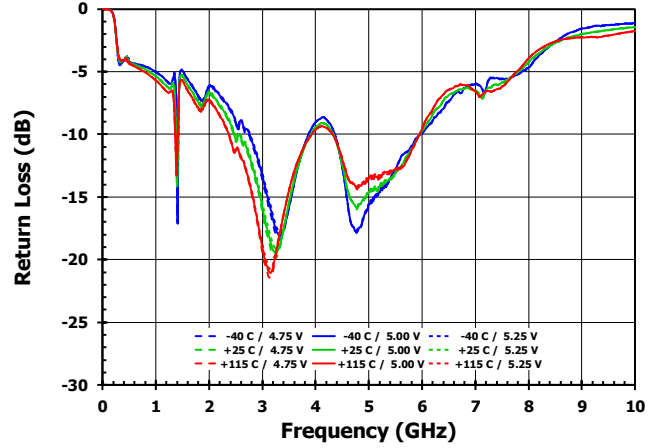

Figure 86. Output Return Loss - High Power Mode, Broadband



Typical Performance Characteristics (Band 4p7 – 4.4GHz to 5.0GHz)

Figure 87. Reverse Isolation - Low Power Mode

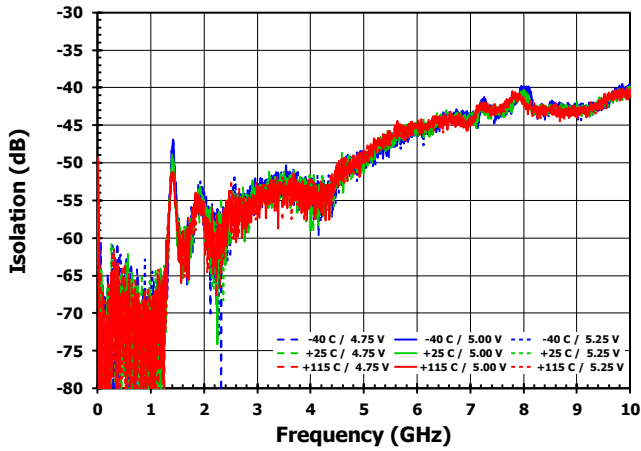

Figure 88. Reverse Isolation - High Power Mode

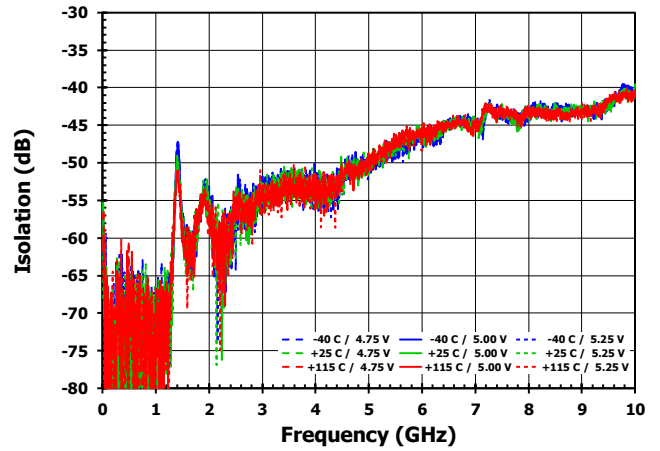

Figure 89. Standby Mode Gain

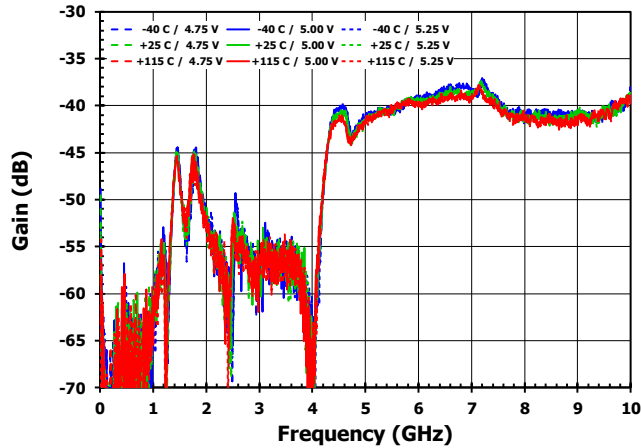

Figure 90. Current versus Power Supply Voltage

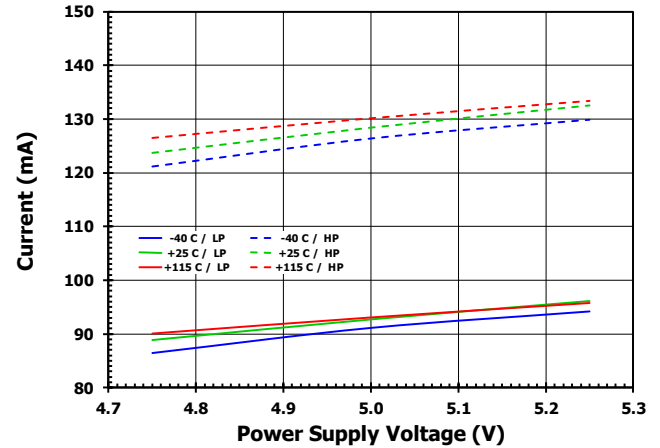

Figure 91. Standby Mode Reverse Isolation

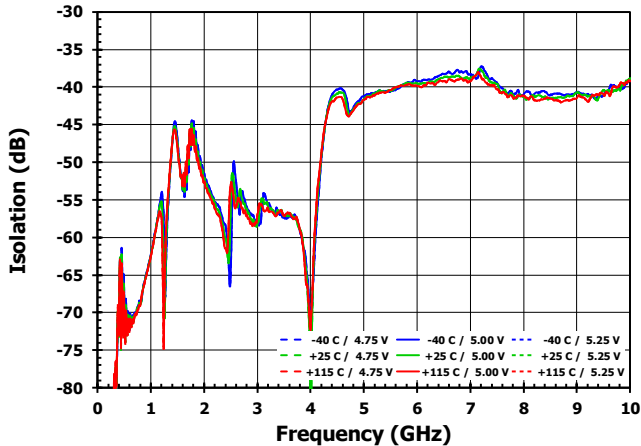
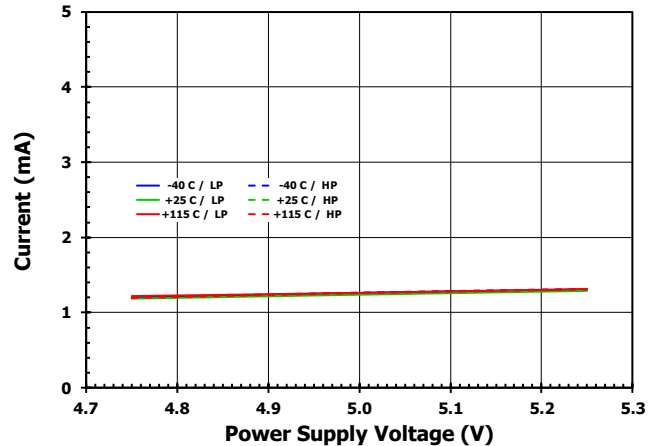

Figure 92. Standby Current versus Power Supply Voltage



Typical Performance Characteristics (Band 4p7 – 4.4GHz to 5.0GHz)

Figure 93. Output IP3 - Low Power Mode

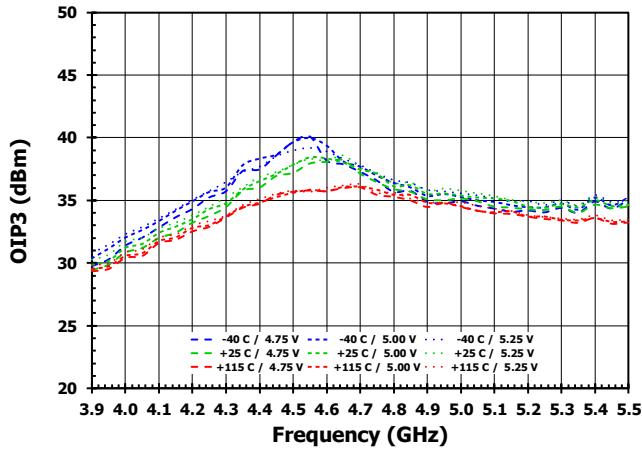

Figure 94. Output IP3 - High Power Mode

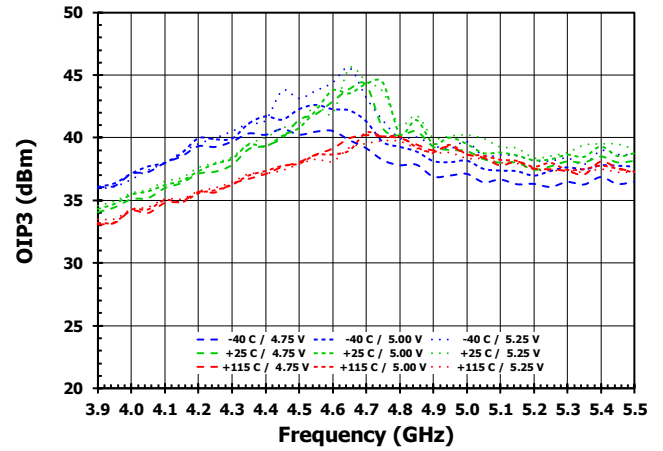

Figure 95. Output Compression - Low Power Mode

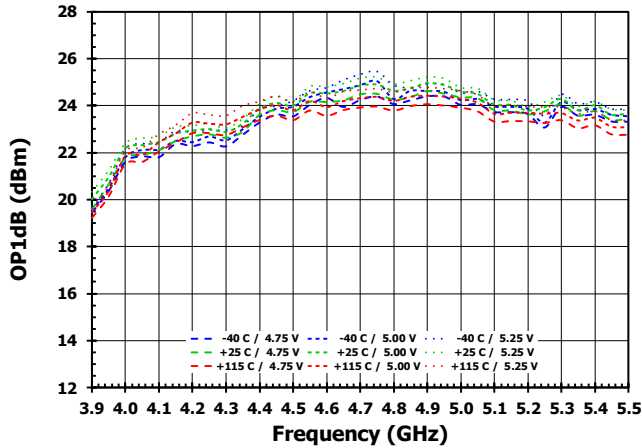

Figure 96. Output Compression - High Power Mode

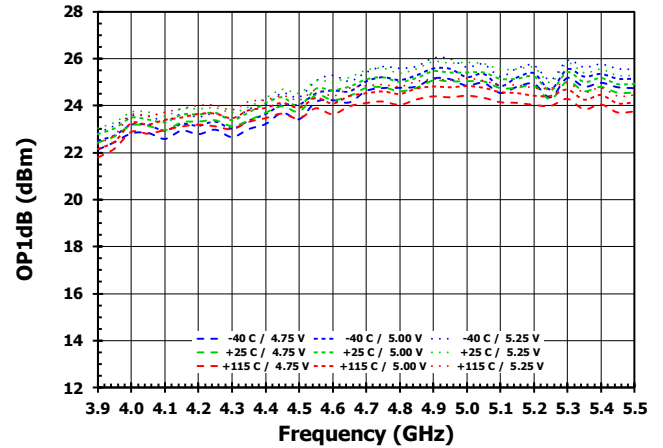

Figure 97. Noise Figure - Low Power Mode

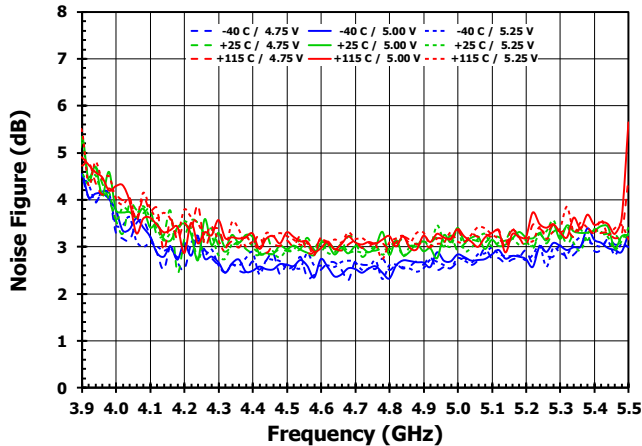
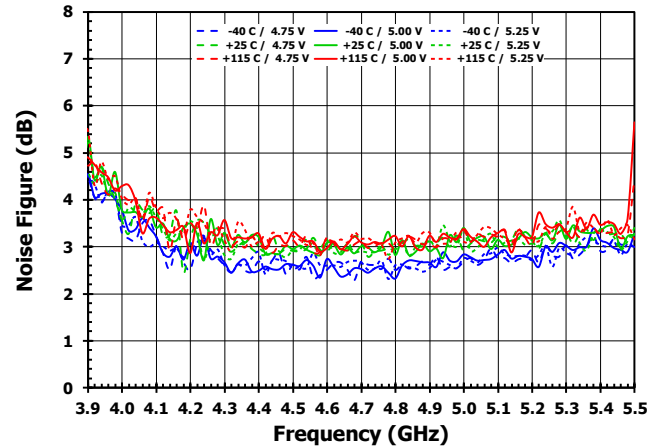

Figure 98. Noise Figure - High Power Mode



Standby

The F1478 can be turned off for low current consumption. This is done by applying a logic voltage to pin 16 using Table 14.

Table 14. Standby Truth Table

STBY	Condition
Logic HIGH	Full operation
Logic LOW	Amplifier OFF

Typical Application Circuit

Figure 99. Typical Application Circuit

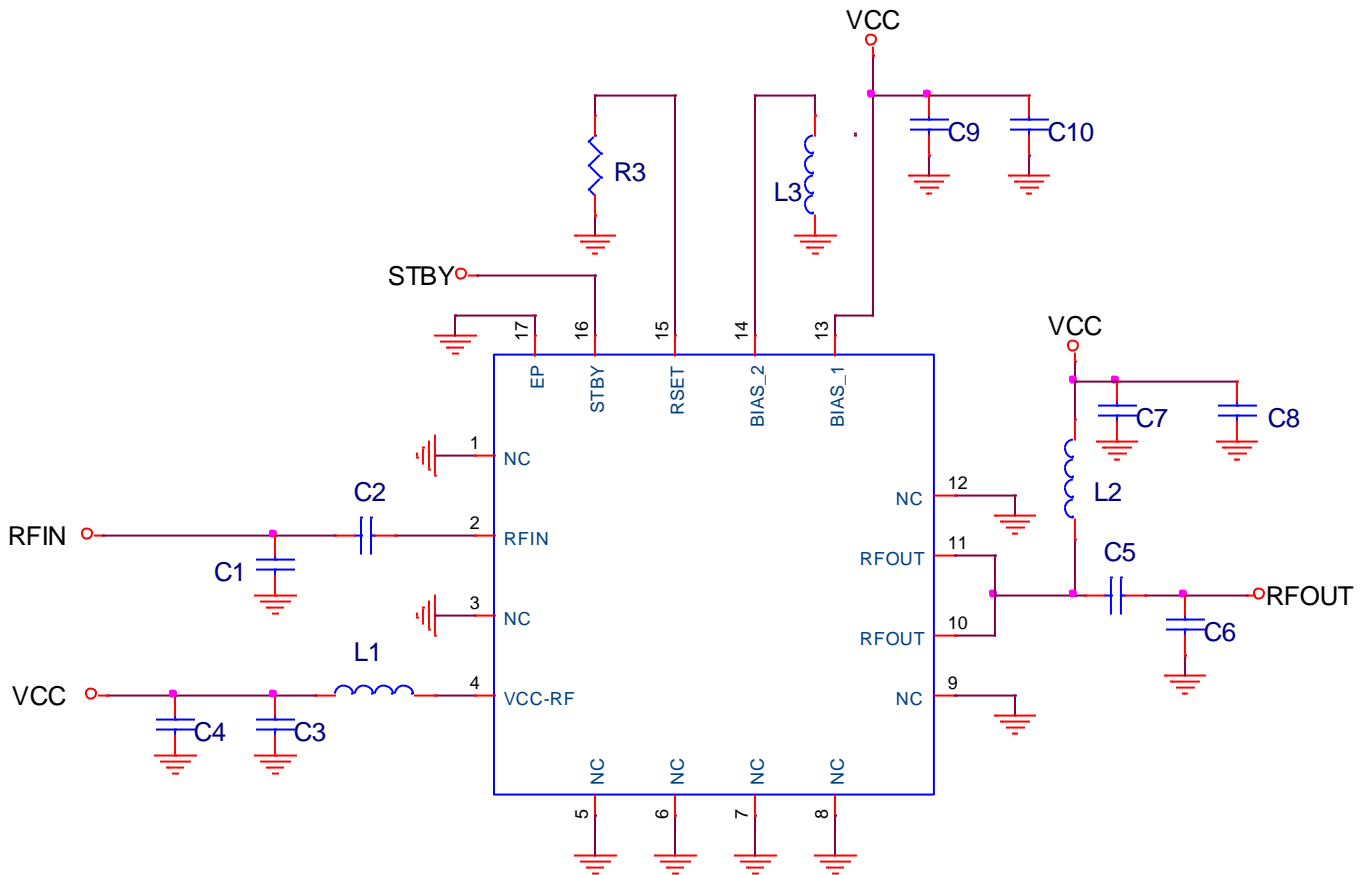

Note 1: All external components are size 0402 *except* C4, C8, and C10. These three capacitors are 0603 components as per the layout shown in Figure 100. Although these capacitors are sized as 0603 on the EVKit, comparable 0402 devices can be used instead.

Note 2: For the 3.3 to 3.8GHz and 4.4 to 5.0GHz bands of operation, the optimal input tuning topology uses a SHUNT INDUCTOR for C1. If there is a DC bias associated with the RF output from a preceding stage, then an additional DC block should be used to prevent a DC short through the shunt inductor placed at C1.

Evaluation Kit Picture

Figure 100. Top View

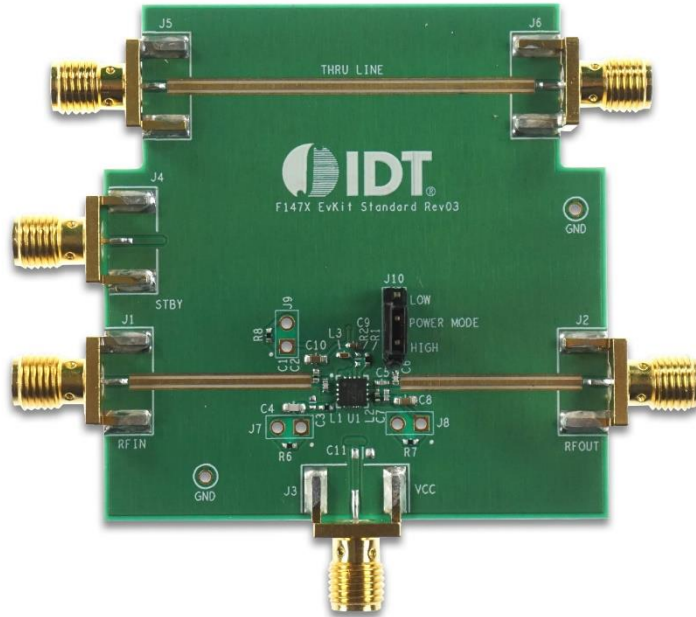
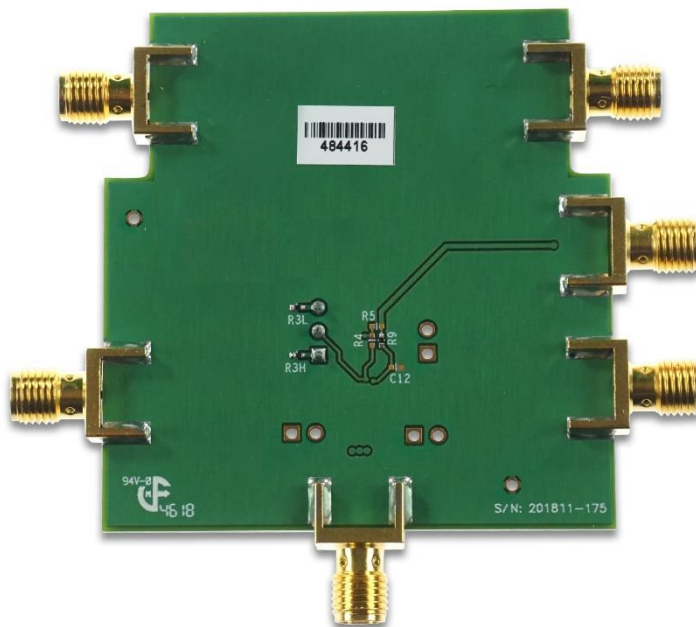

Figure 101. Bottom View



Evaluation Kit Circuit

Figure 102. Electrical Schematic for the Evaluation Board

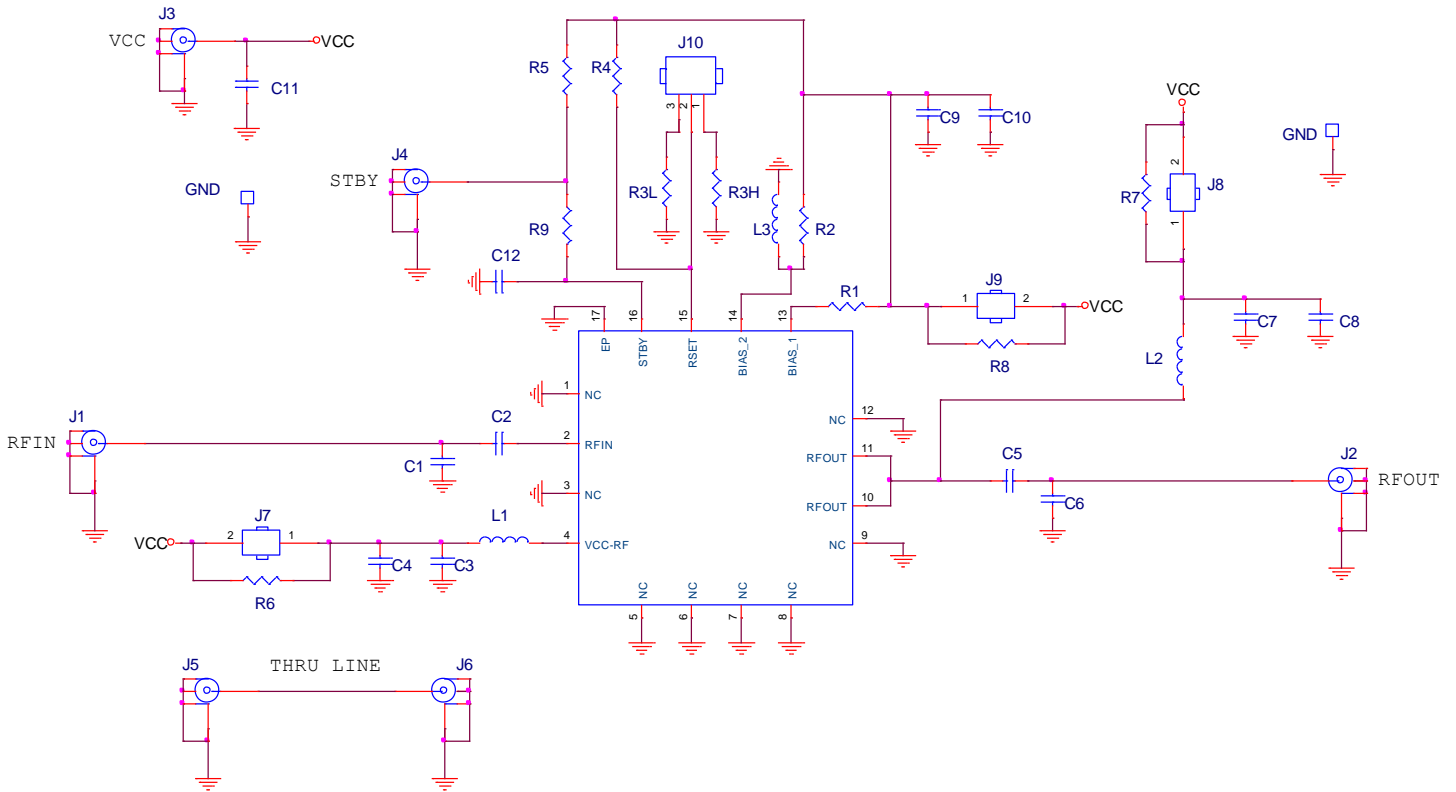

Table 15. Bill of Material (BOM)

Part Reference	QTY	Description	Manufacturer Part #	Manufacturer
C1	1	Band 2p0: 0.9pF \pm 0.1pF, 50V, C0G Ceramic Capacitor (0402)	GJM1555C1HR90B	Murata
		Band 2p5: 0.5pF \pm 0.05pF, 50V, C0G Ceramic Capacitor (0402)	GRM1555C1HR50W	
		Band 3p5: 2.2nH \pm 0.2pF, 900mA Ind (0402)	LQG15HS2N2C02D	Murata
		Band 4p7: 1.8nH \pm 0.2pF, 950mA Ind (0402)	LQG15HS1N8C02D	
C2	1	Band 2p0: 0.1 μ F \pm 5%, 16V, X7R Ceramic Capacitor (0402)	GRM155R71C104K	Murata
		Band 2p5: 0.1 μ F \pm 5%, 16V, X7R Ceramic Capacitor (0402)	GRM155R71C104K	
		Band 3p5: 1.5pF \pm 0.05pF, 50V, C0G Ceramic Capacitor (0402)	GJM1555C1H1R5W	
		Band 4p7: 1.0pF \pm 0.05pF, 50V, C0G Ceramic Capacitor (0402)	GJM1555C1H1R0WD	
C3	1	Band 2p0: 0.5pF \pm 0.05pF, 50V, C0G Ceramic Capacitor (0402)	GRM1555C1HR50W	Murata
		Band 2p5: DNP (Do Not Populate)		
		Band 3p5: DNP (Do Not Populate)		
		Band 4p7: 1.1pF \pm 0.1pF, 50V, C0G Ceramic Capacitor (0402)	GJM1555C1H1R1B	Murata
C4	1	Band 2p0: 0.1 μ F \pm 5%, 50V, X8L Ceramic Capacitor (0603)	GCM188L81H104K	Murata
		Band 2p5: 0.1 μ F \pm 5%, 50V, X8L C0G Ceramic Capacitor (0603)	GCM188L81H104K	
		Band 3p5: 5.1pF \pm 0.25pF, 100V, C0G Ceramic Capacitor (0603)	GQM1885C2A5R1CB	
		Band 4p7: DNP (Do Not Populate)		
C5	1	Band 2p0: 47pF \pm 5%, 50V, C0G Ceramic Capacitor (0402)	GRM1555C1H470J	Murata
		Band 2p5: 10pF \pm 5%, 50V, C0G Ceramic Capacitor (0402)	GRM1555C1H100J	
		Band 3p5: 10pF \pm 5%, 50V, C0G Ceramic Capacitor (0402)	GRM1555C1H100J	
		Band 4p7: 10pF \pm 5%, 50V, C0G Ceramic Capacitor (0402)	GRM1555C1H100J	
C6	1	Band 2p0: 1.3pF \pm 0.05pF, 50V, C0G Ceramic Capacitor (0402)	GJM1555C1H1R3W	Murata

Part Reference	QTY	Description	Manufacturer Part #	Manufacturer
		Band 2p5: 1.2pF \pm 0.05pF, 50V, C0G Ceramic Capacitor (0402)	GRM1555C1H1R2W	
		Band 3p5: 0.3pF \pm 0.05pF%, 50V, C0G Ceramic Capacitor (0402)	GJM1555C1HR30W	
		Band 4p7: 0.3pF \pm 0.05pF, 50V, C0G Ceramic Capacitor (0402)	GJM1555C1HR30W	
C7	1	10pF \pm 5%, 50V, C0G Ceramic Capacitor (0402)	GRM1555C1H100J	Murata
C8	1	0.1 μ F \pm 5%, 50V, X8L Ceramic Capacitor (0603)	GCM188L81H104K	Murata
C9	1	0.1 μ F \pm 5%, 16V, X7R Ceramic Capacitor (0402)	GRM155R71C104K	Murata
C10	1	0.1 μ F \pm 5%, 50V, X8L Ceramic Capacitor (0603)	GCM188L81H104K	Murata
L1	1	Band 2p0: 7.5nH \pm 3%, 550mA Inductor (0402)	LQG15HS7N5H02	Murata
		Band 2p5: 3.0nH \pm 0.3nH, 800mA Inductor (0402)	LQG15HS3N0S02	
		Band 3p5: 7.5 Ω \pm 5%, 1/10W, Chip Resistor (0402)	ERJ-2GEJ7R5X	Panasonic
		Band 4p7: 2.5 Ω \pm 5%, 1/10W, Chip Resistor (0402)	ERJ-2GEJ2R4X	
L2	1	Band 2p0: 27nH \pm 5%, 350mA Inductor (0402)	LQG15HS27NJ02	Murata
		Band 2p5: 18nH \pm 5%, 400mA, Inductor (0402)	LQG15HS18NJ02	
		Band 3p5: 10nH \pm 5%, 500mA, Inductor (0402)	LQG15HS10NJ02	
		Band 4p7: 6.8nH \pm 5%, 600mA, Inductor (0402)	LQG15HS6N8J02	
L3	1	Band 2p0: 6.8nH \pm 5%, 600mA Inductor (0402)	LQG15HS6N8J02	Murata
		Band 2p5: 3.9nH \pm 0.3nH, 750mA Inductor (0402)	LQG15HS3N9S02	
		Band 3p5: 2.4nH \pm 0.1nH, 220mA Inductor (0402)	LQP15MN2N4B02	
		Band 4p7: 1.2nH \pm 0.1nH, 390mA Inductor (0402)	LQP15MN1N2B02	
R1, R6 - R9	1	0 Ω , 1/10W, Resistor (0402)	ERJ-2GE0R00X	Panasonic
R2, R4, R5	0	DNP (Do Not Populate)		
R3	1	High Power Mode: 10k Ω \pm 1%, 0.1W, Resistor (0402)	ERJ-2RKF1002X	Panasonic
		Low Power Mode: 16k Ω \pm 1%, 0.1W, Resistor (0402)	ERJ-2RKF1602X	Panasonic
U1	1	F1478 High Gain RF Amplifier	F1478NLGA	IDT

Evaluation Kit Operation

Power Supply Setup

Set up a power supply in the voltage range of 3.0V to 5.5V, preferably around 5.0V, with the power supply output disabled. Apply the voltage through the J3 connector as shown in Figure 103.

Figure 103. Power Supply Connections

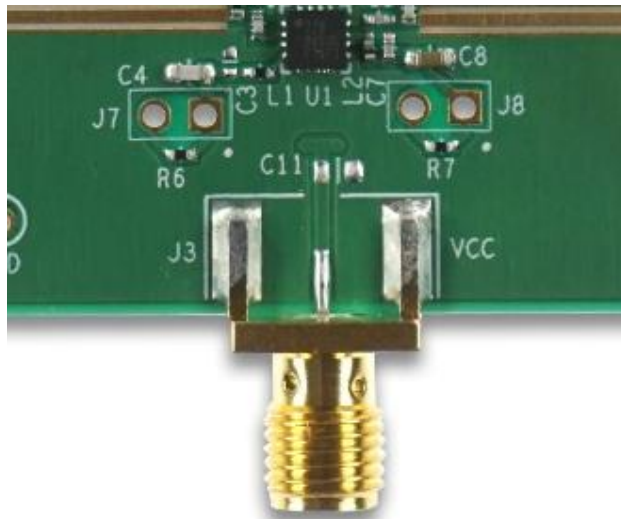

Standby

Set up a power supply in the voltage range of 1.5V to 5.5V with the power supply output disabled. Apply the voltage through the J4 connector as shown in Figure 104.

Figure 104. Standby Connection

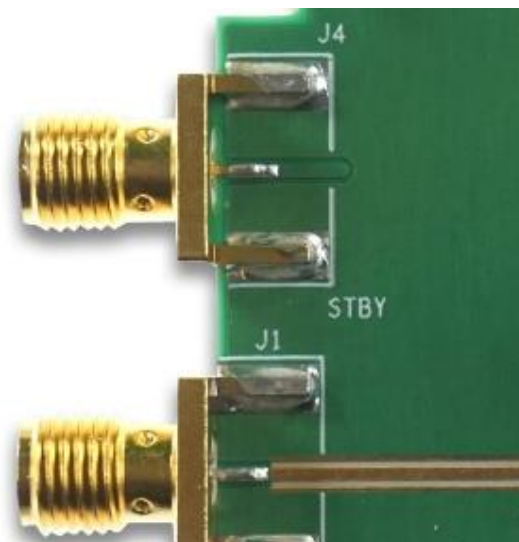

Power-On Procedure

Set up the voltage supplies and Evaluation Board as described in Power Supply Setup

1. Enable the power supply
2. Turn on the power supply

Power-Off Procedure

1. Turn off the power supply
2. Disable the power supply

Application Information

The F1478 has been optimized for use in high performance RF applications ranging from 1.8GHz to 5.0GHz. Separate, broadband tuning options are recommended for operating the device within four sub-bands, specifically 1.8GHz to 2.2GHz (Band 2p0), 2.3GHz to 2.7GHz (Band 2p5), 3.3GHz to 3.8GHz (Band 3p5), and 4.4GHz to 5.0GHz (Band 4p7).

Performance

The high performance is obtained by tuning the F1478 for the input match (RFIN, pin 2), output match (RFOUT, pins 10 and 11), and the interstage V_{CC} (pin 4). RSET (pin 15) is used to set the overall current of the amplifier by setting a resistor to ground. The current will affect all of the amplifier parameters. Bias 2 (pin 13), Bias 1 (pin 14) will mainly affect the intermodulation parameters.

When designing a layout keep the components as close to the package as possible. Use the application circuit shown in Figure 99 and the best RF practices to achieve optimum performance.

Standby Mode (STBY)

The F1478 uses a power down feature for power savings. Connecting pin 16 to a logic HIGH (or leaving the pin unconnected) enables the device. With a logic LOW applied to pin 16, the amplifier is placed in standby mode. The Standby mode is a high isolation state. The level of this isolation is not specified and is dependent on the device.

Digital Pin Voltage and Resistance Values

Table 16 provides the open-circuit DC voltage referenced to ground and resistance values for each of the control pins listed.

Table 16. Digital Pin Voltages and Resistance

Pin	Name	Open Circuit DC Voltage	Internal Connection
16	STBY	V_{CC}	100k Ω pull-up resistor to V_{CC}

Power Supplies

A common V_{CC} power supply should be used for all power supply pins. To minimize noise and fast transients, add de-coupling capacitors to all supply pins. Supply noise can degrade noise figure and fast transients can trigger ESD clamps causing them to fail. Supply voltage change or transients should have a slew rate smaller than $1V / 20\mu s$. In addition, all control pins should remain at 0V ($\pm 0.3V$) while the supply voltage ramps or while it returns to zero.

If control signal integrity is a concern and clean signals cannot be guaranteed due to overshoot, undershoot, ringing, etc., the following circuit is recommended at the input of each control pin. This applies to the standby pin (16) as shown below. Note the recommended resistor and capacitor values do not necessarily match the EVKit BOM for the case of poor control signal integrity. For multiple devices driven by a single control line, the component values will need to be adjusted accordingly so as not to load down the control line.

Figure 105. Control Pin Interface for Signal Integrity

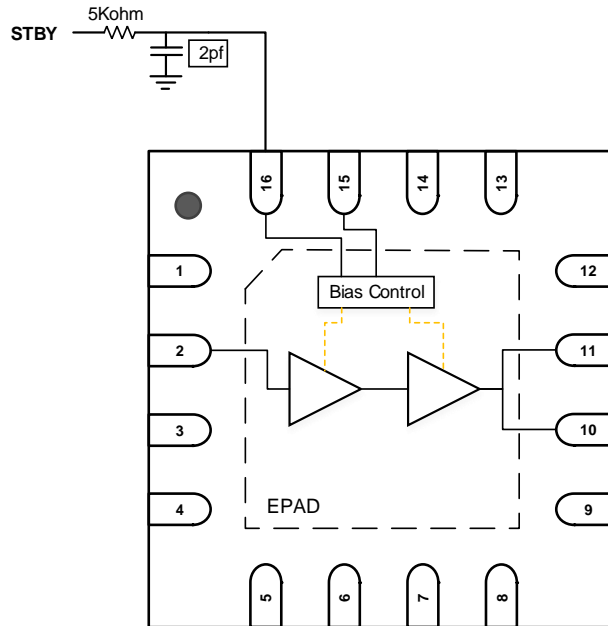

Package Outline Drawings

The package outline drawings are appended at the end of this document and are accessible from the link below. The package information is the most current data available.

www.idt.com/document/psc/16-vfqfn-package-outline-drawing-30-x-30-x-090-mm-050mm-pitch-160-x-160-mm-epad-nlg16p3

Ordering Information

Orderable Part Number	Package	MSL Rating	Shipping Packaging	Temperature
F1478NLGA	3 × 3 × 0.9 mm 16-pin VFQFPN	MSL 3	Tray	-40° to +115°C
F1478NLGA8	3 × 3 × 0.9 mm 16-pin VFQFPN	MSL 3	Tape and Reel	-40° to +115°C
F1478EVB-2p0	Evaluation Board for Band 2p0 – 1.8GHz to 2.2GHz			
F1478EVB-2p5	Evaluation Board for Band 2p5 – 2.3GHz to 2.7GHz			
F1478EVB-3p5	Evaluation Board for Band 3p5 – 3.3GHz to 3.9GHz			
F1478EVB-4p7	Evaluation Board for Band 4p7 – 4.4GHz to 5.0GHz			

Marking Diagram

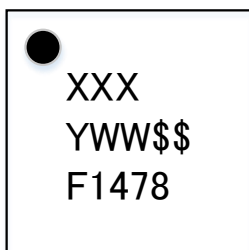

- Line 1 “XXX” represents the last three digits of the lot number.
- Line 2 “YWW” has one digit for the year and two digits for week that the part was assembled. “\$\$” denotes the assembly site.
- Line 3 “F1478” is the part number.

Revision History

Revision Date	Description of Change
March 29, 2019	Initial release.

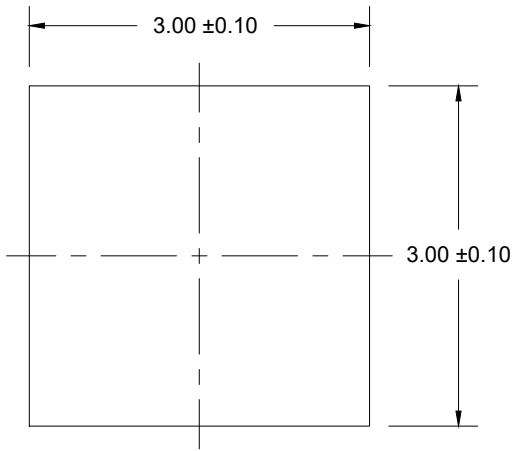

Top View

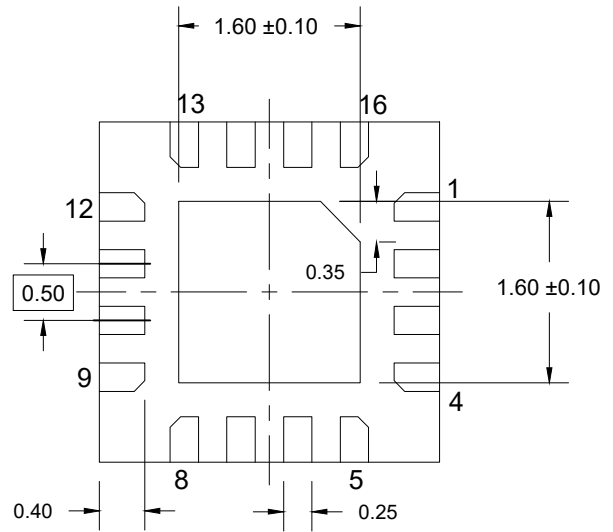

Side View

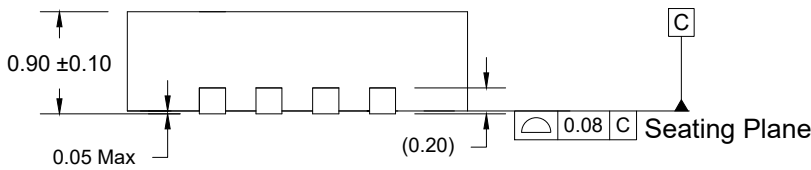

Side View

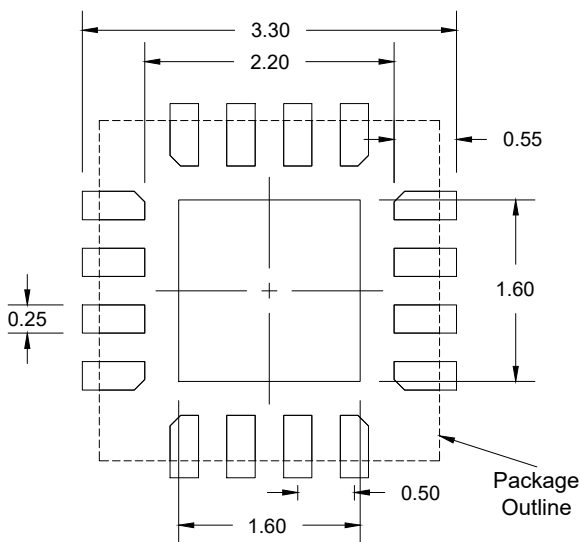

Recommended Land Pattern
(PCB Top View, NSMD Design)

Notes:

1. JEDEC compatible.
2. All dimensions are in mm. and angle are in degrees.
3. Use ± 0.50 mm. for the non-toleranced dimensions.
4. Numbers in () are for references only.

IMPORTANT NOTICE AND DISCLAIMER

RENESAS ELECTRONICS CORPORATION AND ITS SUBSIDIARIES (“RENESAS”) PROVIDES TECHNICAL SPECIFICATIONS AND RELIABILITY DATA (INCLUDING DATASHEETS), DESIGN RESOURCES (INCLUDING REFERENCE DESIGNS), APPLICATION OR OTHER DESIGN ADVICE, WEB TOOLS, SAFETY INFORMATION, AND OTHER RESOURCES “AS IS” AND WITH ALL FAULTS, AND DISCLAIMS ALL WARRANTIES, EXPRESS OR IMPLIED, INCLUDING, WITHOUT LIMITATION, ANY IMPLIED WARRANTIES OF MERCHANTABILITY, FITNESS FOR A PARTICULAR PURPOSE, OR NON-INFRINGEMENT OF THIRD PARTY INTELLECTUAL PROPERTY RIGHTS.

These resources are intended for developers skilled in the art designing with Renesas products. You are solely responsible for (1) selecting the appropriate products for your application, (2) designing, validating, and testing your application, and (3) ensuring your application meets applicable standards, and any other safety, security, or other requirements. These resources are subject to change without notice. Renesas grants you permission to use these resources only for development of an application that uses Renesas products. Other reproduction or use of these resources is strictly prohibited. No license is granted to any other Renesas intellectual property or to any third party intellectual property. Renesas disclaims responsibility for, and you will fully indemnify Renesas and its representatives against, any claims, damages, costs, losses, or liabilities arising out of your use of these resources. Renesas' products are provided only subject to Renesas' Terms and Conditions of Sale or other applicable terms agreed to in writing. No use of any Renesas resources expands or otherwise alters any applicable warranties or warranty disclaimers for these products.

(Disclaimer Rev.1.0 Mar 2020)

Corporate Headquarters

TOYOSU FORESIA, 3-2-24 Toyosu,
Koto-ku, Tokyo 135-0061, Japan
www.renesas.com

Contact Information

For further information on a product, technology, the most up-to-date version of a document, or your nearest sales office, please visit:
www.renesas.com/contact/

Trademarks

Renesas and the Renesas logo are trademarks of Renesas Electronics Corporation. All trademarks and registered trademarks are the property of their respective owners.