

RAA212422

Dual channel 40V 1.1A and 5.5V 1.5A synchronous buck regulators

FN9326  
Rev.1.00  
Jul 8, 2019

The [RAA212422](#) is a dual output regulator combining a 1.1A synchronous buck regulator with an input range of 3V to 40V with a 1.5A synchronous buck regulator with an input voltage range of 2.7V to 5.5V. Because both high-side and low-side MOSFETs are integrated for both regulators, the RAA212422 provides an easy-to-use, high-efficiency, and low BOM-count solution for a variety of applications.

Both regulators feature internal and external compensation, thermal shutdown, and power-good functions. The wide  $V_{IN}$  buck regulator features a PFM mode for improved efficiency at light load. This feature can be disabled if forced PWM mode is desired. It switches at a default frequency of 500kHz; however, it can also be programmed using an external resistor from 300kHz to 2MHz. Other features include programmable soft-start and hiccup overcurrent protection.

The low  $V_{IN}$  buck regulator operates at 1MHz switching frequency, which provides fast load transient response allowing the use of small inductors. Because the high-side MOSFET of the low  $V_{IN}$  buck regulator is a PMOS, a boot capacitor is not needed, reducing the external component count. They operate at 100% duty cycle and in PWM mode only, reducing noise susceptibility and RF interference.

The RAA212422 is available in a small RoHS compliant 3mmx6mm TDFN plastic package with a full-range industrial temperature of -40°C to +125°C.

**Related Literature**

For a full list of related documents, visit our website:

- [RAA212422](#) device page

**Features**

- Wide  $V_{IN}$  buck regulator
  - Input voltage: 3V to 40V with 1.1A output current
  - Internal fixed frequency (500kHz) or adjustable switching frequencies (300kHz to 2MHz)
  - Selectable PFM or PWM mode at light loads
  - Internal or external soft-start
- Low  $V_{IN}$  buck regulator
  - Input voltage: 2.7V to 5.5V, with 1.5A output current
  - $V_{OUT}$  range: 0.6V to  $V_{IN}$
  - Fixed 1MHz switching frequency
- Synchronous operation for high efficiency
- Integrated high-side and low-side MOS devices
- Internal or external compensation option
- Power-good and enable functions
- Thermal shutdown

**Applications**

- Industrial control, medical devices, portable instrumentation, distributed power supplies, and cloud infrastructure
- General purpose point of load DC/DC, set-top boxes and cable modems, FPGA power, DVD, HDD drives, LCD panels, and TV

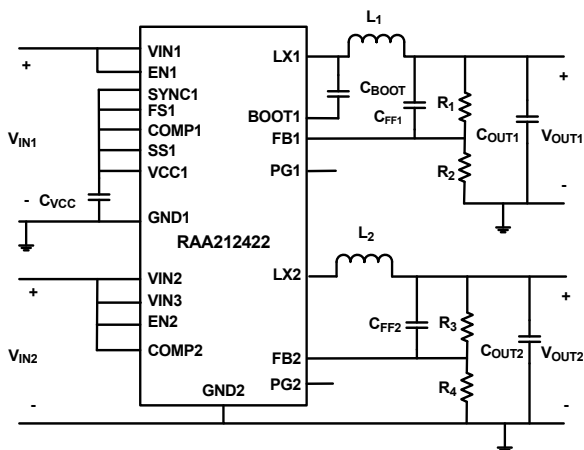

Figure 1. Typical Application

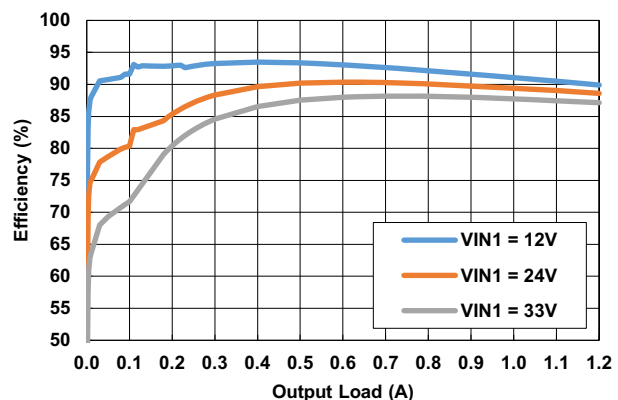

Figure 2. Efficiency vs Load,  $V_{OUT1} = 5V$ ,  $L_1 = 22\mu H$

## Contents

<b>1. Overview</b>	<b>3</b>
1.1 Typical Application Circuits	3
1.2 Block Diagram	5
1.3 Ordering Information	6
1.4 Pin Configurations	6
1.5 Pin Descriptions	6
<b>2. Specifications</b>	<b>8</b>
2.1 Absolute Maximum Ratings	8
2.2 Thermal Information	8
2.3 Recommended Operating Conditions	9
2.4 Electrical Specifications	9
<b>3. Typical Performance Curves</b>	<b>12</b>
3.1 Efficiency Curves	12
3.2 Measurements	15
<b>4. Detailed Description</b>	<b>21</b>
4.1 Power-On Reset /UVLO	21
4.2 Soft-Start (Wide $V_{IN}$ and Low $V_{IN}$ Buck)	21
4.3 Power-Good	21
4.4 PWM Control Scheme (Wide $V_{IN}$ and Low $V_{IN}$ Buck)	22
4.5 Light Load Operation	22
4.6 Output Voltage Selection	23
4.7 Protection Features	24
4.8 Discharge Mode/Soft-Stop (Low $V_{IN}$ Buck)	25
4.9 100% Duty Cycle (Low $V_{IN}$ Buck)	25
4.10 Power Derating Characteristics	25
<b>5. Application Guidelines</b>	<b>26</b>
5.1 Simplifying the Design	26
5.2 Operating Frequency (Wide $V_{IN}$ Buck)	26
5.3 Minimum On/Off-Time Limitation	26
5.4 Synchronization Control (Wide $V_{IN}$ Buck)	27
5.5 Output Inductor Selection	27
5.6 Input Capacitor Selection	27
5.7 Output Capacitor Selection	27
5.8 Loop Compensation Design	28
<b>6. Layout Suggestions</b>	<b>32</b>
<b>7. Revision History</b>	<b>33</b>
<b>8. Package Outline Drawing</b>	<b>34</b>

# 1. Overview

## 1.1 Typical Application Circuits

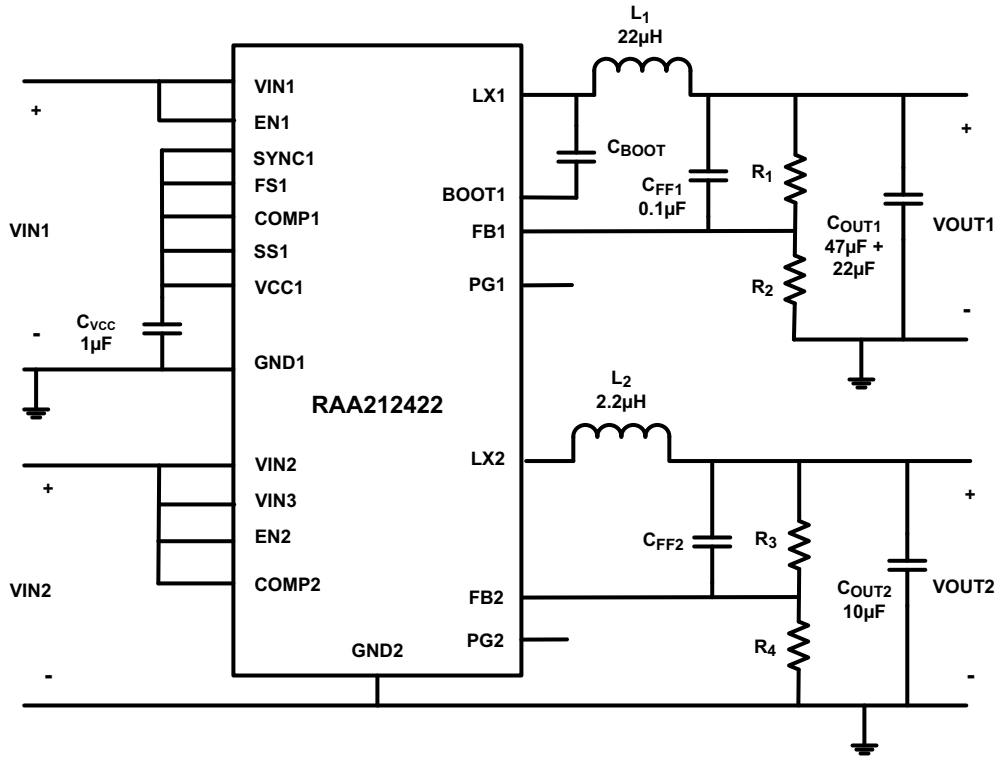

Figure 3. Internal Default Parameter Selection

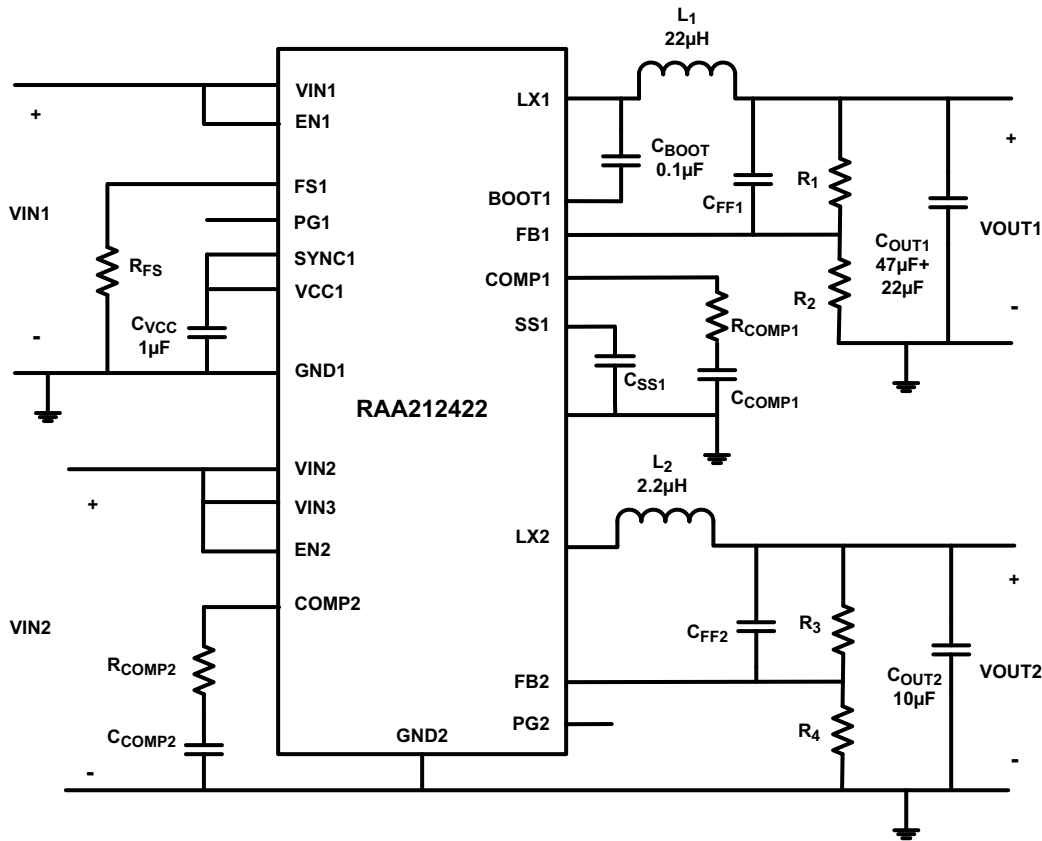

Figure 4. User Programmable Parameter Selection

Table 1. Wide VIN Buck Regulator - External Component Selection

V <sub>OUT1</sub> (V)	L <sub>1</sub> (µH)	C <sub>OUT1</sub> (µF)	R <sub>1</sub> (kΩ)	R <sub>2</sub> (kΩ)	C <sub>FF1</sub> (pF)	R <sub>FS</sub> (kΩ)	R <sub>COMP1</sub> (kΩ)	C <sub>COMP1</sub> (pF)
12	33	2 x 22	90.9	4.75	4.7	115	200	470
5	22	47 + 22	90.9	12.4	22	DNP (Note 1)	130	470
3.3	22	47 + 22	90.9	20	22	DNP (Note 1)	120	470
2.5	22	47 + 22	90.9	28.7	22	DNP (Note 1)	110	470
1.8	10	47 + 22	90.9	45.5	22	DNP (Note 1)	90	470

Note:

1. Connect FS1 to VCC1.

Table 2. Low VIN Buck Regulator - External Component Selection

V <sub>OUT2</sub> (V)	L <sub>1</sub> (µH)	C <sub>OUT2</sub> (µF)	R <sub>3</sub> (kΩ)	R <sub>4</sub> (kΩ)	C <sub>FF2</sub> (pF)	R <sub>COMP1</sub> (kΩ)	C <sub>COMP1</sub> (pF)
0.8	1.5	2x22	33	100	47	40	270
1.2	2.2	2x22	100	100	22	60	270
1.8	2.2	2x22	200	100	15	80	330
2.5	2.2	2x22	316	100	8.2	100	330
3.3	2.2	2x22	450	100	6.8	120	330

### 1.2 Block Diagram

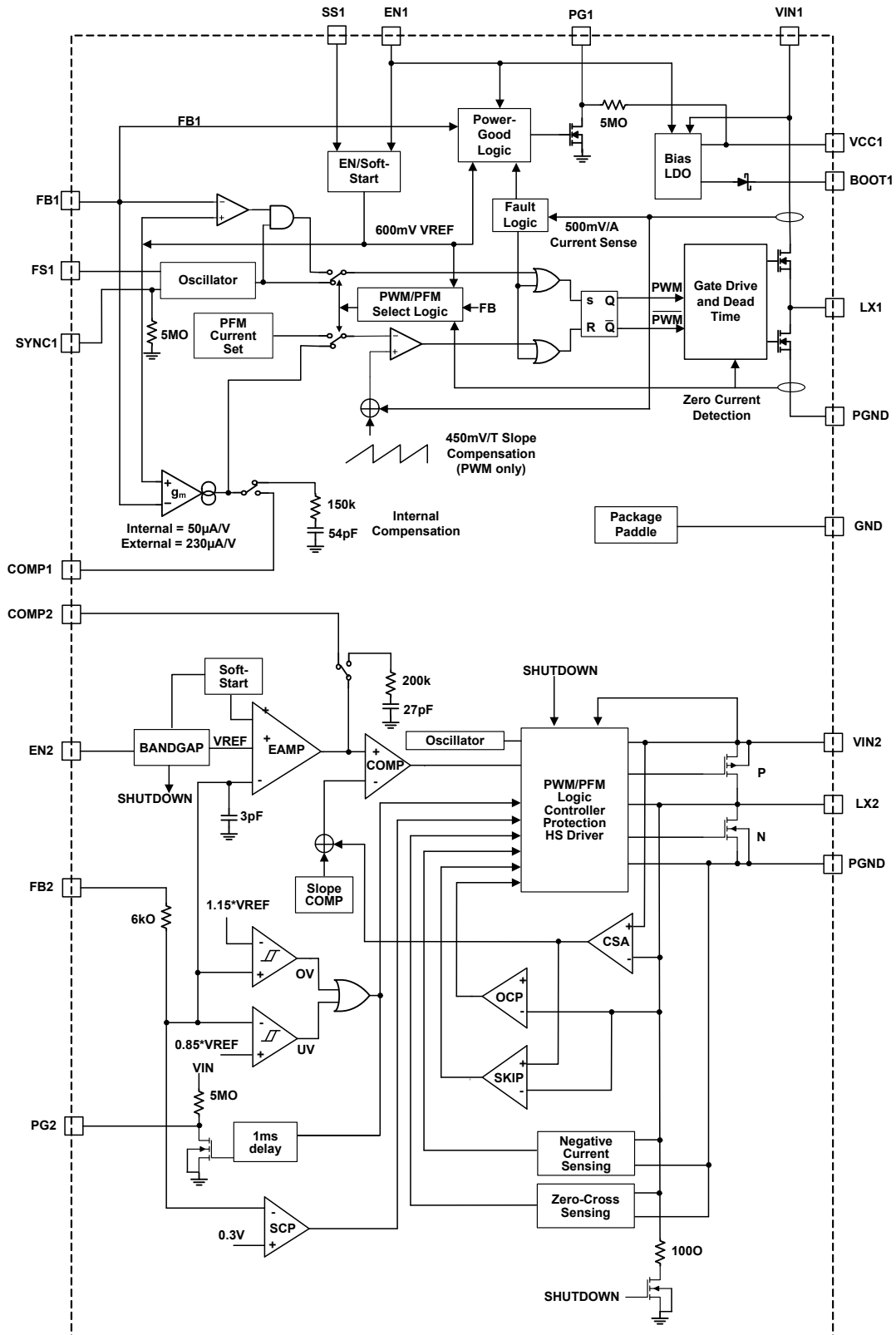

Figure 5. Functional Block Diagram

### 1.3 Ordering Information

Part Number (Notes 3, 4)	Part Marking	Temp Range (°C)	Tape and Reel (Units) (Note 2)	Package (RoHS Compliant)	Pkg. Dwg. #
RAA2124224GNP#AA0	RAA212422	-40 to +125	-	22 Ld QFN	L22.3x6
RAA2124224GNP#HA0	RAA212422	-40 to +125	6k	22 Ld QFN	L22.3x6
RAA2124224GNP#MA0	RAA212422	-40 to +125	250	22 Ld QFN	L22.3x6

Notes:

- See [TB347](#) for details about reel specifications
- These Pb-free plastic packaged products employ special Pb-free material sets, molding compounds/die attach materials, and 100% matte tin plate plus anneal (e3 termination finish, which is RoHS compliant and compatible with both SnPb and Pb-free soldering operations). Pb-free products are MSL classified at Pb-free peak reflow temperatures that meet or exceed the Pb-free requirements of IPC/JEDEC J STD-020.
- For Moisture Sensitivity Level (MSL), see the [RAA212422](#) device page. For more information about MSL, see [TB363](#).

### 1.4 Pin Configurations

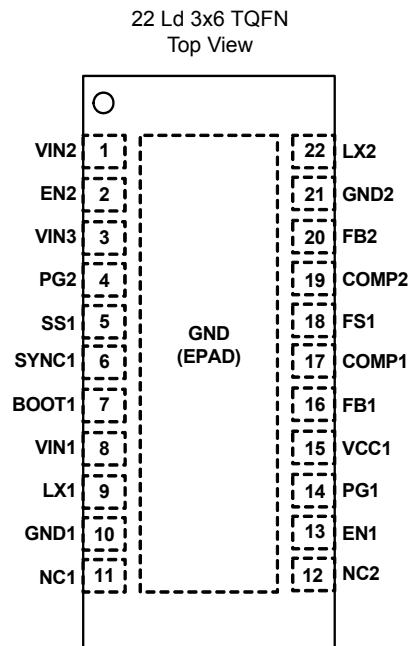

### 1.5 Pin Descriptions

Pin Number	Pin Name	Description
1	VIN2	Input supply for the power stage of the low $V_{IN}$ PWM regulator and the source for the internal linear regulator that provides bias for the low $V_{IN}$ buck regulator. Place a minimum of 10 $\mu$ F ceramic capacitance from VIN2 to GND and as close as possible to the IC for decoupling. The input voltage range is 2.7V to 5.5V.
2	EN2	Device enable input for the low $V_{IN}$ buck regulator. When the input voltage on this pin rises above 1.4V, the device is enabled. The device is disabled when the pin is pulled to ground. A 100 $\Omega$ resistor discharges the output through the LX2 pin when the device is disabled. See <a href="#">Figure 5 on page 5</a> for details.
3	VIN3	Connect VIN3 to VIN2.
4	PG2	Power-good output of the low $V_{IN}$ buck regulator. PG2 is pulled to ground during the soft-start interval and when the output voltage is below regulation limits. An internal 5M $\Omega$ pull-up resistor is on this pin.
5	SS1	Controls the soft-start ramp time for the output of the wide $V_{IN}$ buck regulator. A single capacitor from the SS1 pin to ground determines the output ramp rate. See <a href="#">“Soft-Start (Wide <math>V_{IN}</math> and Low <math>V_{IN}</math> Buck)” on page 21</a> for soft-start details. If the SS1 pin is tied to VCC1, an internal soft-start of 2ms is used.

Pin Number	Pin Name	Description
6	SYNC1	Synchronization and light load operational mode selection input. Connect to logic high or VCC for PWM mode. Connect to logic low or ground for PFM mode. Logic ground enables the IC to automatically choose PFM or PWM operation. Connect to an external clock source for synchronization with positive edge trigger. Sync source must be higher than the programmed IC frequency. There is an internal 5MΩ pull-down resistor to prevent an undefined logic state if SYNC is left floating.
7	BOOT1	Floating bootstrap supply pin for the power MOSFET gate driver for the wide $V_{IN}$ buck regulator. The bootstrap capacitor provides the necessary charge to turn on the internal N-channel MOSFET. Connect an external 100nF capacitor from this pin to LX1.
8	VIN1	The input supply for the power stage of the wide $V_{IN}$ buck regulator and the source for the internal linear bias regulator. Place a minimum of 4.7μF ceramic capacitance from VIN1 to GND1 and close to the IC for decoupling. The input voltage range is 3V to 40V.
9	LX1	Switch node output. It connects the switching FETs with the external output inductor.
10	GND1	Power ground connection. Connect directly to the system GND plane.
11	NC1	No connect
12	NC2	
13	EN1	Wide $V_{IN}$ buck regulator enable input. The regulator and bias LDO are held off when the pin is pulled to ground. When the voltage on this pin rises above 1V, the chip is enabled. Connect this pin to VIN1 for automatic start-up. Do not connect the EN1 pin to VCC1 because the LDO is controlled by EN1 voltage.
14	PG1	Open-drain, power-good output that is pulled to ground when the output voltage of the wide $V_{IN}$ buck regulator is below regulation limits or during the soft-start interval. An internal 5MΩ pull-up resistor is on this pin.
15	VCC1	Output of the wide $V_{IN}$ buck regulator's internal 5V linear bias regulator. Decouple to GND with a 1μF ceramic capacitor at the pin.
16	FB1	Feedback pin for the wide $V_{IN}$ buck regulator. FB1 is the inverting input to the voltage loop error amplifier. COMP1 is the output of the error amplifier. The output voltage is set by an external resistor divider connected to FB1. In addition, the PWM regulator's power-good and UVLO circuits use FB1 to monitor the regulator output voltage.
17	COMP1	Error amplifier output. When this pin is tied to VCC1, internal compensation is used. When only an RC network is connected from COMP1 to GND1, external compensation is used. See <a href="#">"Loop Compensation Design" on page 28</a> for more details.
18	FS1	Frequency selection pin for the wide $V_{IN}$ buck regulator. Tie to VCC1 for 500kHz switching frequency. Connect a resistor to GND1 for adjustable frequency from 300kHz to 2MHz.
19	COMP2	Low $V_{IN}$ buck regulator error amplifier. When COMP2 is tied high to VIN2, internal compensation is used. When COMP2 is connected with a series resistor and capacitor to GND, external compensation is used. See <a href="#">"Loop Compensation Design" on page 28</a> for more details.
20	FB2	Feedback pin for the low $V_{IN}$ buck regulator. FB2 is the negative input to the voltage loop error amplifier. The output voltage is set by an external resistor divider connected to FB2. In addition, the power-good PWM regulator's power-good and undervoltage protection circuits use FB2 to monitor the output voltage.
21	GND2	Power ground for low $V_{IN}$ buck regulator. Connect directly to the system ground plane.
22	LX2	Power stage switching node for output voltage regulation of the low $V_{IN}$ buck regulator. Connect to the output inductor. This pin is discharged by a 100Ω resistor when the device is disabled. See <a href="#">Figure 5 on page 5</a> for details.
EPAD	GND	Ground connection. Connect to the application board GND plane with at least five vias. All voltage levels are measured with respect to this pin. The EPAD MUST NOT float.

## 2. Specifications

### 2.1 Absolute Maximum Ratings

Parameter	Minimum	Maximum	Unit
VIN1 to GND	-0.3	+43	V
LX1 to GND (DC)	-0.3	$V_{IN1} + 0.3$	V
LX1 to GND (20ns)	-2.0	+44	V
EN1 to GND	-0.3	+43	V
BOOT1 to LX1	-0.3	+5.5	V
COMP1, FS1, PG1, SYNC1, SS1, VCC1 to GND	-0.3	+5.9	V
FB1 to GND	-0.3	+2.95	V
VIN2 to GND (DC)	-0.3	+6	V
VIN2 to GND (20ms)	-0.3	+7	V
LX2 to GND (DC)	-0.3	+6	V
LX2 to GND (100ns)	-1.5	+7	V
LX2 to GND (20ms)	-0.3	+7	V
EN2, COMP2, PG2, MODE2	-0.3	$V_{IN2} + 0.3$	V
FB2	-0.3	+2.7	V
ESD Rating	Value		Unit
Human Body Model (Tested per JS-001-2017)	2		kV
Charged Device Model (Tested per JS-002-2014)	1		kV
Latch-Up (Tested per JESD78E; Class 2, Level A)	100		mA

CAUTION: Do not operate at or near the maximum ratings listed for extended periods of time. Exposure to such conditions can adversely impact product reliability and result in failures not covered by warranty.

### 2.2 Thermal Information

Thermal Resistance (Typical)	$\theta_{JA}$ (°C/W)	$\theta_{JC}$ (°C/W)
22 Ld 3x6 QFN Package ( <a href="#">Notes 5, 6</a> )	31.3	2.3

Notes:

- $\theta_{JA}$  is measured in free air with the component mounted on a high-effective thermal conductivity test board with "direct attach" features. See [TB379](#).
- For  $\theta_{JC}$ , the "case temp" location is the center of the exposed metal pad on the package underside.

Parameter	Minimum	Maximum	Unit
Maximum Junction Temperature		+150	°C
Maximum Storage Temperature Range	-65	+150	°C
Ambient Temperature Range	-40	+125	°C
Pb-Free Reflow Profile	Refer to <a href="#">TB493</a>		



## 2.3 Recommended Operating Conditions

Parameter	Minimum	Maximum	Unit
Supply Voltage, $V_{IN1}$	3	40	V
Supply Voltage, $V_{IN2}$	2.7	5.5	V
Junction Temperature	-40	+125	°C

## 2.4 Electrical Specifications

$V_{IN1}$  = 3V to 40V, unless otherwise noted. Typical values are at  $T_A$  = +25°C.

Parameter	Symbol	Test Conditions	Min (Note 9)	Typ	Max (Note 9)	Unit
<b>Wide <math>V_{IN}</math> Buck Regulator</b>						
<b>Supply Voltage</b>						
$V_{IN1}$ Voltage Range	$V_{IN1}$		3		40	V
$V_{IN1}$ Quiescent Supply Current	$I_{Q1}$	$V_{FB1} = 0.7V$ , $SYNC1 = V_{CC1}$		8		mA
$V_{IN1}$ Shutdown Supply Current	$I_{SD1}$	$EN1 = 0V$ , $V_{IN1} = 40V$ (Note 7)		2	6	μA
$V_{CC1}$ Voltage	$V_{CC1}$	$V_{IN1} = 6V$ , $I_{OUT1} = 0$ to 10mA	4.5	5.1	5.7	V
<b>Power-On Reset</b>						
$V_{CC1}$ POR Threshold		Rising edge		2.75	2.95	V
		Falling edge	2.35	2.6		V
<b>Oscillator</b>						
Nominal Switching Frequency	$f_{SW1}$	$FS1$ pin = $V_{CC1}$	430	500	570	kHz
		Resistor from the $FS1$ pin to GND = 340kΩ	240	300	360	kHz
		Resistor from the $FS1$ pin to GND = 32.4kΩ		2000		kHz
Minimum Off-Time	$t_{MIN\_OFF}$	$V_{IN1} = 3V$		150		ns
Minimum On-Time	$t_{MIN\_ON}$	(Note 10)		90		ns
$FS1$ Voltage	$V_{FS1}$	$R_{FS1} = 100k\Omega$	0.39	0.4	0.41	V
Synchronization Frequency	$SYNC1$		300		2000	kHz
$SYNC1$ Pulse-Width			100			ns
<b>Error Amplifier</b>						
Error Amplifier Transconductance Gain	$g_{m1}$	External compensation	165	230	295	μA/V
		Internal compensation		50		μA/V
FB1 Leakage Current		$V_{FB1} = 0.6V$		1	150	nA
Current Sense Amplifier Gain	$R_{T1}$		0.44	0.5	0.55	V/A
FB1 Voltage		$T_A = -40^\circ C$ to $+125^\circ C$	0.590	0.599	0.607	V
<b>Power-Good</b>						
Lower PG1 Threshold - VFB1 Rising				90	94	%
Lower PG1 Threshold - VFB1 Falling			82.5	86		%
Upper PG1 Threshold - VFB1 Rising				116.5	120	%
Upper PG1 Threshold - VFB1 Falling			107	112		%
PG1 Propagation Delay		Percentage of the soft-start time		10		%

$V_{IN1} = 3V$  to  $40V$ , unless otherwise noted. Typical values are at  $T_A = +25^\circ C$ . (Continued)

Parameter	Symbol	Test Conditions	Min (Note 9)	Typ	Max (Note 9)	Unit
PG1 Low Voltage		$I_{SINK} = 3mA$ , $EN1 = V_{CC}$ , $V_{FB1} = 0V$		0.05	0.3	V
<b>Tracking and Soft-Start (SS1)</b>						
Soft-Start Charging Current	$I_{SS1}$		4.2	5.5	6.7	$\mu A$
Internal Soft-Start Ramp Time		$EN1/SS1 = V_{CC1}$	1.5	2.4	3.4	ms
<b>Fault Protection</b>						
Thermal Shutdown Temperature	$T_{SD}$	Rising threshold		150		$^\circ C$
	$T_{HYS}$	Hysteresis		25		$^\circ C$
Current Limit Blanking Time	$t_{OCON}$			17		Clock pulses
Overcurrent and Auto Restart Period	$t_{OCCOFF}$			8		SS cycle
Positive Peak Current Limit	$I_{PLIMIT}$	(Note 8)	1.3	1.6	1.8	A
PFM Peak Current Limit	$I_{PK\_PFM}$	(Note 8)	0.34	0.4	0.5	A
Zero Cross Threshold				15		mA
Negative Current Limit	$I_{NLIMIT}$	(Note 8)	-0.68	-0.6	-0.53	A
<b>Power MOSFET</b>						
High-Side	$R_{HDS}$	$I_{LX1} = 100mA$ , $V_{CC} = 5V$		312		$m\Omega$
Low-Side	$R_{LDS}$	$I_{LX1} = 100mA$ , $V_{CC} = 5V$		173.8		$m\Omega$
PHASE Leakage Current		$EN1 = LX1 = 0V$			300	nA
PHASE Rise Time	$t_{RISE}$	$V_{IN1} = 40V$		10		ns
<b>EN1/SYNC1</b>						
Input Threshold		Falling edge, logic low	0.4	1		V
		Rising edge, logic high		1.2	1.4	V
EN1 Logic Input Leakage Current		$EN1 = 0V/40V$	-0.65		0.65	$\mu A$
SYNC1 Logic Input Leakage Current		$SYNC1 = 0V$		10	100	nA
		$SYNC1 = 5V$		1.0	1.55	$\mu A$
<b>Low <math>V_{IN}</math> Buck Regulator</b>						
<b>Input Supply</b>						
$V_{IN2}$ Undervoltage Lockout Threshold	$V_{UVLO2}$	Rising, no load		2.5	2.7	V
		Falling, no load	2.2	2.4		V
Quiescent Supply Current	$I_{VIN2}$	$f_{SW} = 1MHz$ , no load at the output		7	15	mA
Shut Down Supply Current	$I_{SD2}$	$V_{IN2} = 5.5V$ , $EN2 = low$		5	10	$\mu A$
<b>Output Regulation</b>						
Feedback Voltage	$V_{FB2}$	$T_J = +25^\circ C$	0.595	0.600	0.605	V
		$T_J = -40^\circ C$ to $+125^\circ C$	0.582		0.605	V
$V_{FB2}$ Bias Current	$I_{VFB2}$	$V_{FB2} = 2.7V$ , $T_J = -40^\circ C$ to $+125^\circ C$	-120	50	350	nA
Line Regulation		$V_{IN2} = V_O + 0.5V$ to $5.5V$ (minimal $2.7V$ ) $T_J = -40^\circ C$ to $+125^\circ C$	-0.2	-0.05	0.1	%/V
Load Regulation		See Note 11		< -0.2		%/A
Soft-Start Ramp Time Cycle				1		ms

$V_{IN1}$  = 3V to 40V, unless otherwise noted. Typical values are at  $T_A$  = +25°C. (Continued)

Parameter	Symbol	Test Conditions	Min (Note 9)	Typ	Max (Note 9)	Unit
<b>Protections</b>						
Positive Peak Current Limit	$I_{PLIMIT}$	1.5A application	2.1	2.5	2.9	A
Zero Cross Threshold			-170	-70	30	mA
Negative Current Limit	$I_{NLIMIT}$		-2.3	-1.75	-1	A
Thermal Shutdown		Temperature rising		150		°C
Thermal Shutdown Hysteresis		Temperature falling		25		°C
<b>Compensation</b>						
Error Amplifier Transconductance		COMP2 tied VIN2		40		$\mu$ A/V
		COMP2 with RC		160		$\mu$ A/V
Transresistance	$R_T$		0.24	0.3	0.40	$\Omega$
<b>Power MOSFETs</b>						
P-Channel MOSFET ON-Resistance		$V_{IN2} = 5V, I_{O2} = 200mA$		117		m $\Omega$
N-Channel MOSFET ON-Resistance		$V_{IN2} = 5V, I_{O2} = 200mA$		86		m $\Omega$
LX2 Maximum Duty Cycle				100		%
LX2 Minimum On-Time		(Note 10)		60	85	ns
<b>Oscillator</b>						
Nominal Switching Frequency	$f_{SW2}$		850	1000	1150	kHz
<b>Power-Good</b>						
Output Low Voltage		1mA sinking current			0.3	V
Delay Time (Rising Edge)			0.5	1	2	ms
PGOOD Delay Time (Falling Edge)				15		$\mu$ s
PG2 Pin Leakage Current		$PG2 = V_{IN2}$		0.01	0.1	$\mu$ A
OVP PG2 Rising Threshold			110	119	122	%
OVP PG2 Hysteresis				5		%
UVP PG2 Rising Threshold			80	85	90	%
UVP PG2 Hysteresis				5		%
<b>Enable Logic</b>						
Logic Input Low			0.4			V
Logic Input High					1.4	V
Logic Input Leakage Current	$I_{MODE2}$	Pulled up to 5.5V		5.5	8	$\mu$ A

Notes:

- Test conditions:  $V_{IN1} = 40V$ , FB1 forced above regulation point (0.6V), switching and power MOSFET gate charging current not included.
- Established by both current sense amplifier gain test and current sense amplifier output test at  $I_L = 0A$ .
- Parameters with Min and/or Max limits are 100% tested at +25°C, unless otherwise specified. Temperature limits established by characterization and are not production tested.
- Minimum On-Time required to maintain loop stability.
- Not tested in production. Characterized using evaluation board. See load regulation diagrams (Figures 16 through 19). +105°C  $T_A$  represents near worst case operating point.

### 3. Typical Performance Curves

#### 3.1 Efficiency Curves

Wide  $V_{IN}$  Buck  $f_{SW} = 500\text{kHz}$ ,  $T_A = +25^\circ\text{C}$

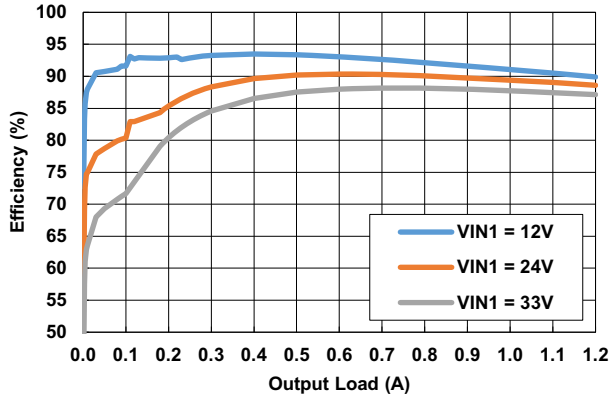

Figure 6. Efficiency vs Load, PFM,  $V_{OUT1} = 5\text{V}$ ,  $L_1 = 22\mu\text{H}$ ,

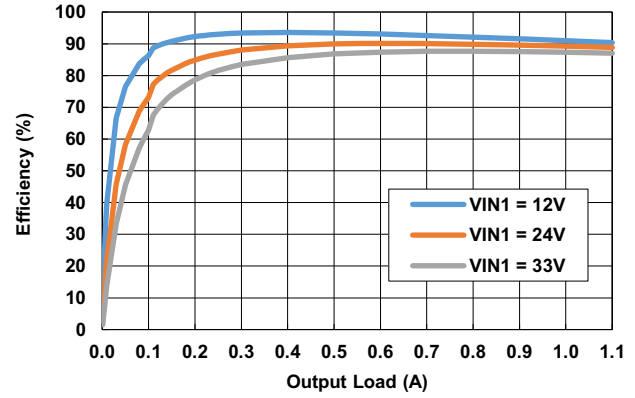

Figure 7. Efficiency vs Load, PWM,  $V_{OUT1} = 5\text{V}$ ,  $L_1 = 22\mu\text{H}$ ,

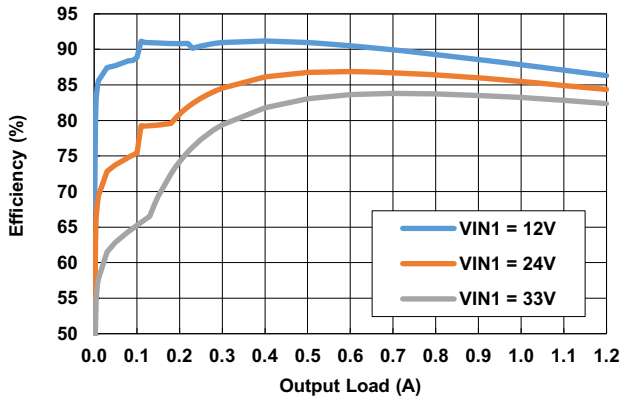

Figure 8. Efficiency vs Load, PFM,  $V_{OUT1} = 3.3\text{V}$ ,  $L_1 = 22\mu\text{H}$

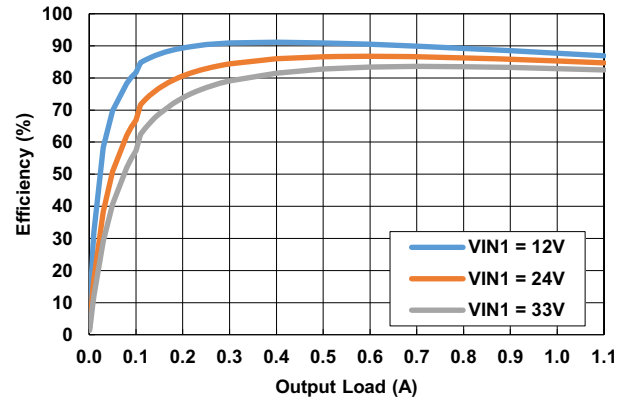

Figure 9. Efficiency vs Load, PWM,  $V_{OUT1} = 3.3\text{V}$ ,  $L_1 = 22\mu\text{H}$

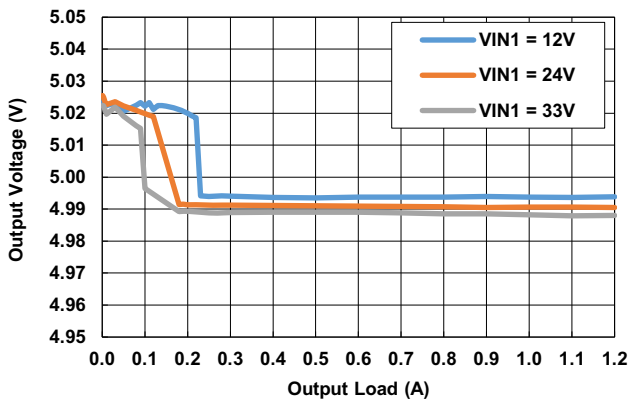

Figure 10.  $V_{OUT}$  Regulation vs Load, PFM,  $V_{OUT1} = 5\text{V}$

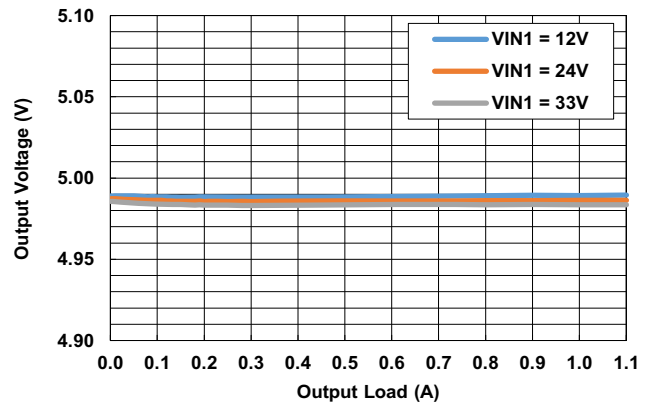

Figure 11.  $V_{OUT}$  Regulation vs Load, PWM,  $V_{OUT1} = 5\text{V}$

Wide  $V_{IN}$  Buck  $f_{SW} = 500kHz$ ,  $T_A = +25^\circ C$  (Continued)

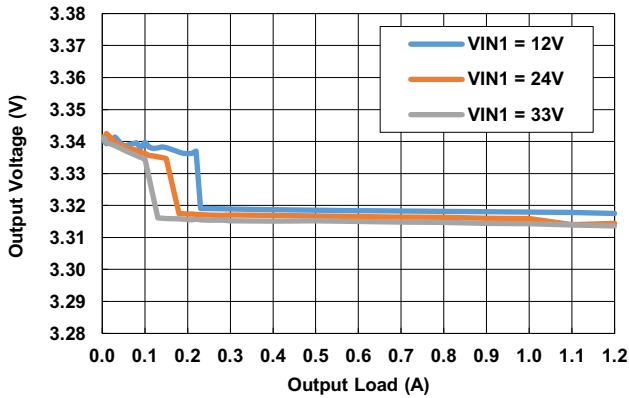

Figure 12.  $V_{OUT}$  Regulation vs Load, PFM,  $V_{OUT1} = 3.3V$

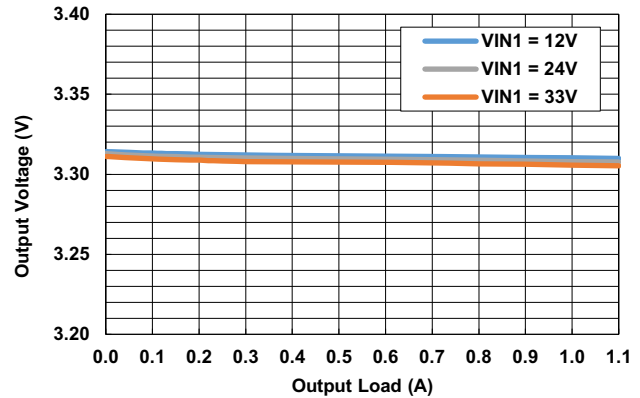

Figure 13.  $V_{OUT}$  Regulation vs Load, PWM,  $V_{OUT1} = 3.3V$

Low  $V_{IN}$  Buck  $f_{SW} = 1MHz$ ,  $T_A = +25^\circ C$

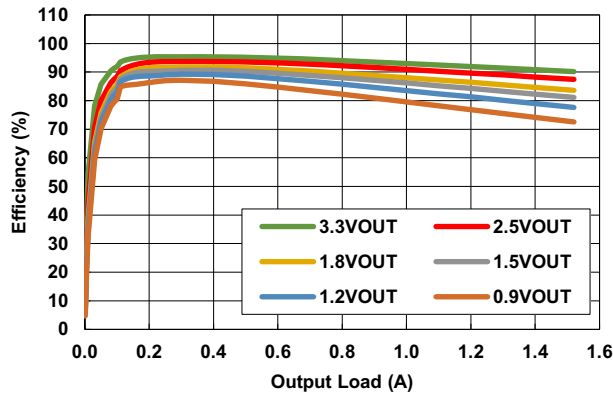

Figure 14. Efficiency vs Load,  $V_{IN2} = 5V$

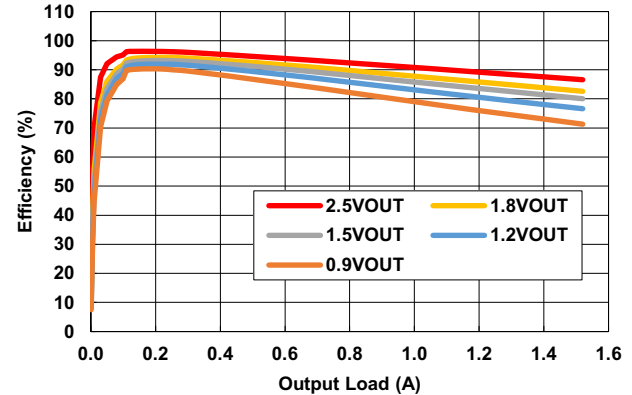

Figure 15. Efficiency vs Load,  $V_{IN2} = 3.3V$

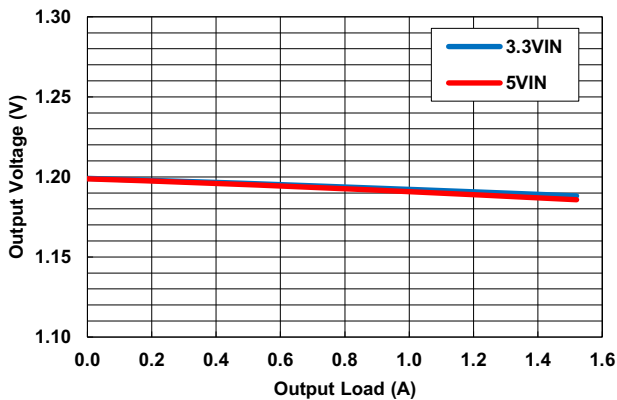

Figure 16.  $V_{OUT}$  Regulation vs Load,  $V_{OUT2} = 1.2V$

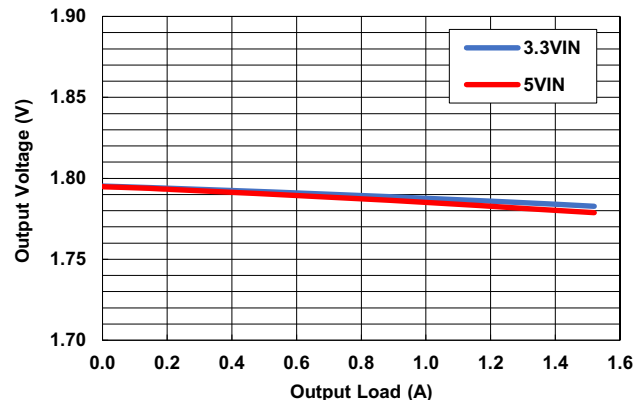

Figure 17.  $V_{OUT}$  Regulation vs Load,  $V_{OUT2} = 1.8V$ ,

Low  $V_{IN}$  Buck  $f_{SW} = 1\text{MHz}$ ,  $T_A = +25^\circ\text{C}$  (Continued)

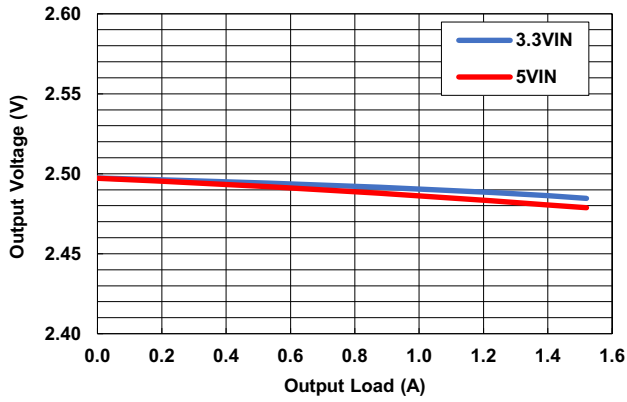

Figure 18.  $V_{OUT}$  Regulation vs Load,  $V_{OUT2} = 2.5\text{V}$

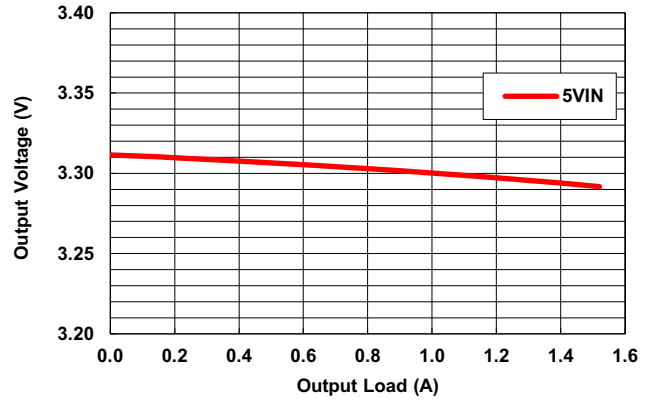

Figure 19.  $V_{OUT}$  Regulation vs Load,  $V_{OUT2} = 3.3\text{V}$

### 3.2 Measurements

Wide  $V_{IN}$  Buck Measurements  $f_{SW} = 500kHz$ ,  $V_{IN1} = 24V$ ,  $V_{OUT1} = 5V$ ,  $T_A = +25^\circ C$

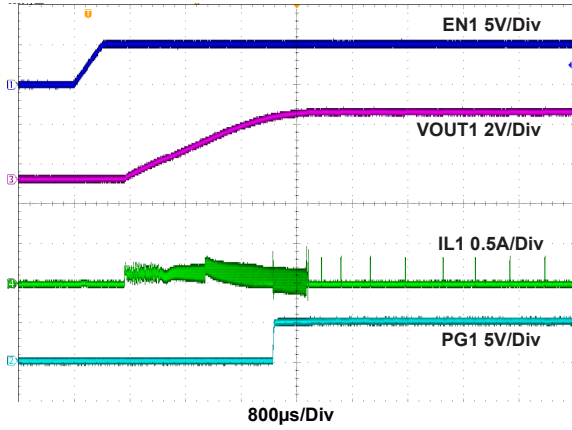

Figure 20. Start-Up at No Load,  $V_{OUT1} = 3.3V$ , PFM

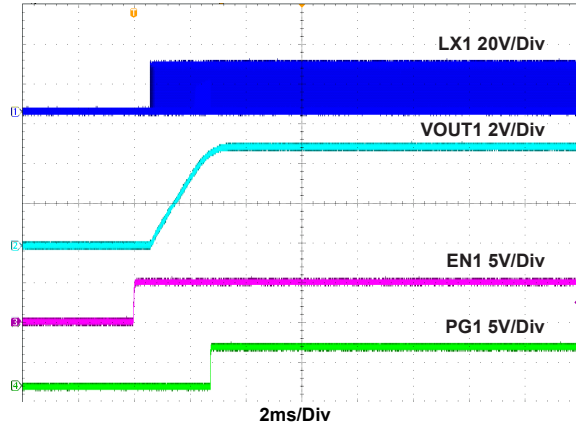

Figure 21. Start-Up at No Load, PWM

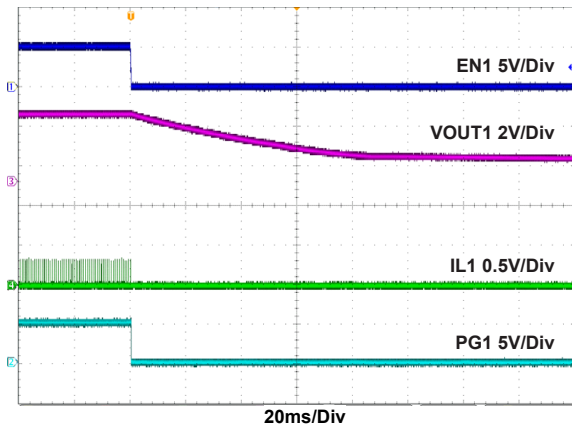

Figure 22. Shutdown at No Load,  $V_{OUT1} = 3.3V$ , PFM

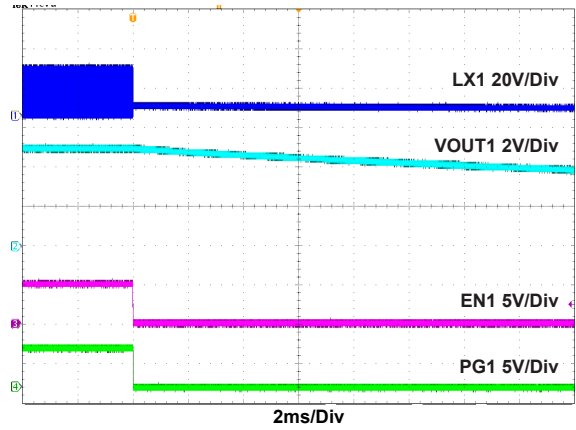

Figure 23. Shutdown at No Load, PWM

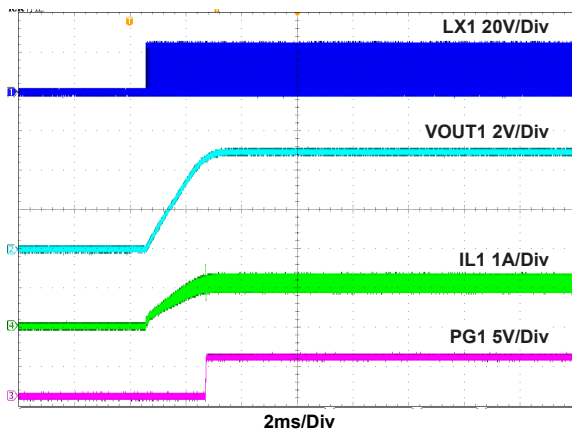

Figure 24. Start-Up at 1.1A, PWM

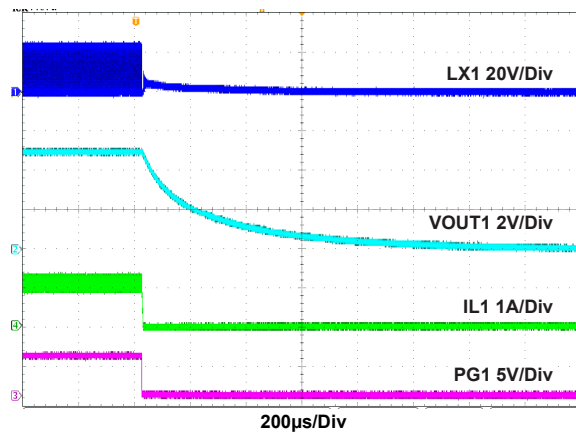

Figure 25. Shutdown at 1.1A, PWM

Wide  $V_{IN}$  Buck Measurements  $f_{SW} = 500kHz$ ,  $V_{IN1} = 24V$ ,  $V_{OUT1} = 5V$ ,  $T_A = +25^\circ C$  (Continued)

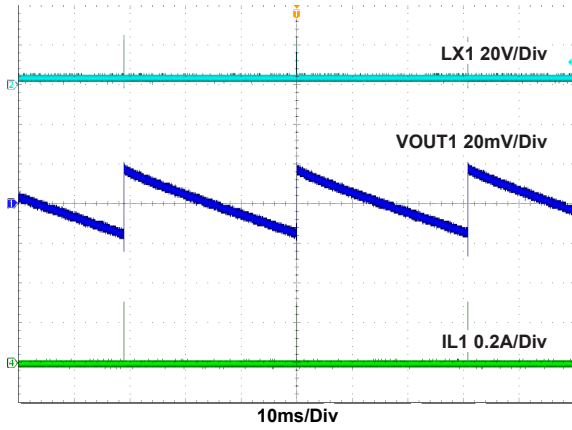

Figure 26. Steady State at No Load, PFM

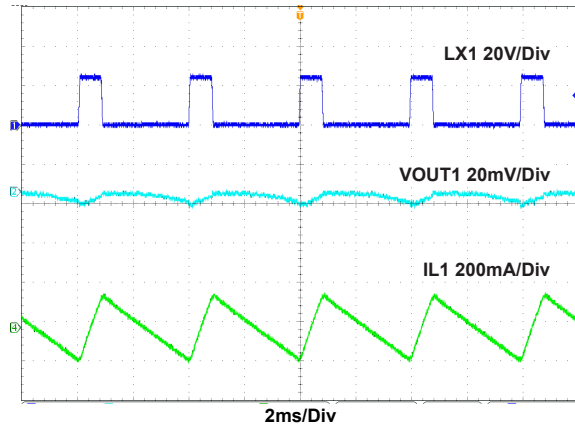

Figure 27. Steady State at No Load, PWM

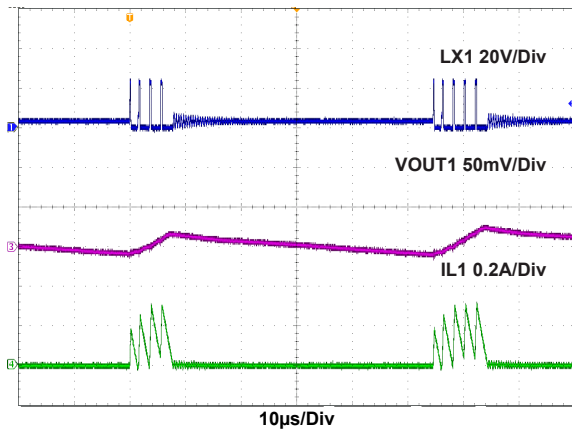

Figure 28. Light Load Operation at 20mA, PFM

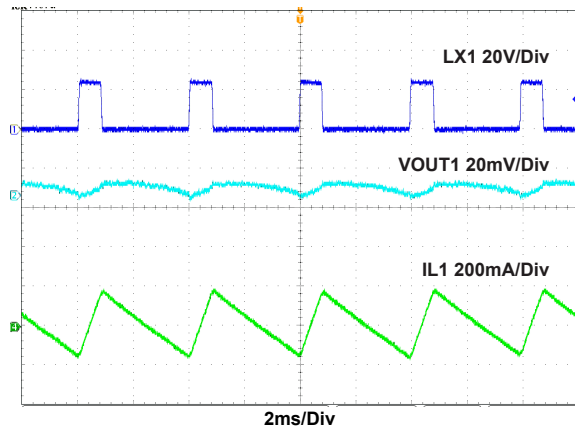

Figure 29. Light Load Operation at 20mA, PWM

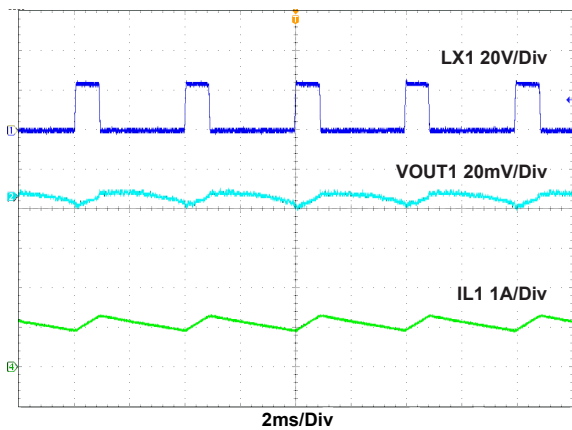

Figure 30. Steady State at 1.1A Load

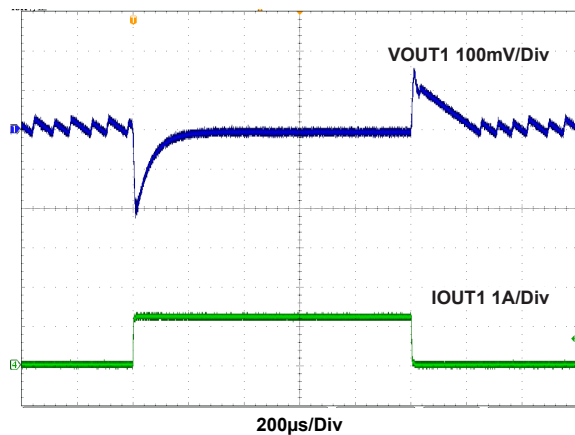

Figure 31. Load Transient, PFM



Wide  $V_{IN}$  Buck Measurements  $f_{SW} = 500\text{kHz}$ ,  $V_{IN1} = 24\text{V}$ ,  $V_{OUT1} = 5\text{V}$ ,  $T_A = +25^\circ\text{C}$  (Continued)

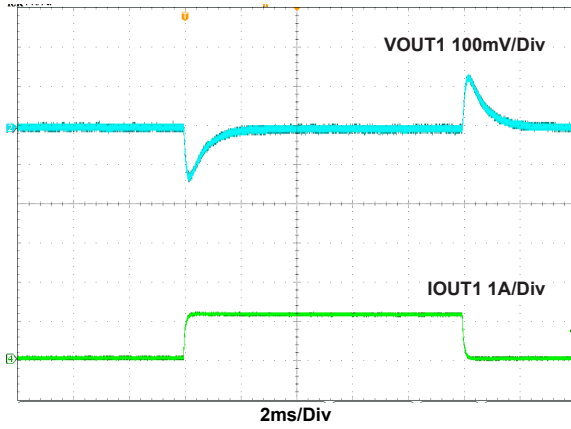

Figure 32. Load Transient, PWM

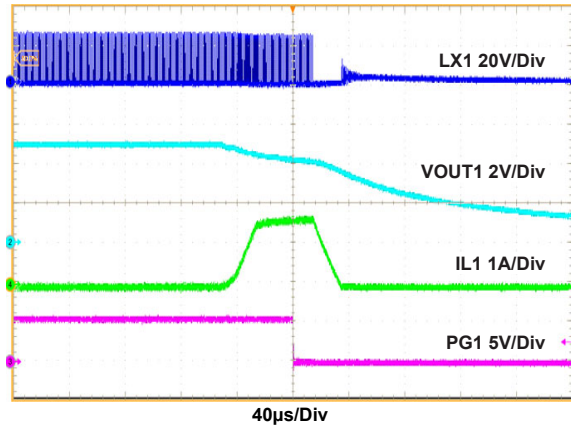

Figure 33. Overcurrent Protection

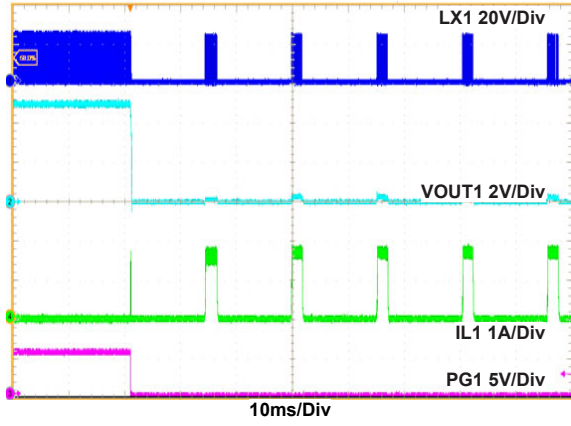

Figure 34. Overcurrent Protection Hiccup

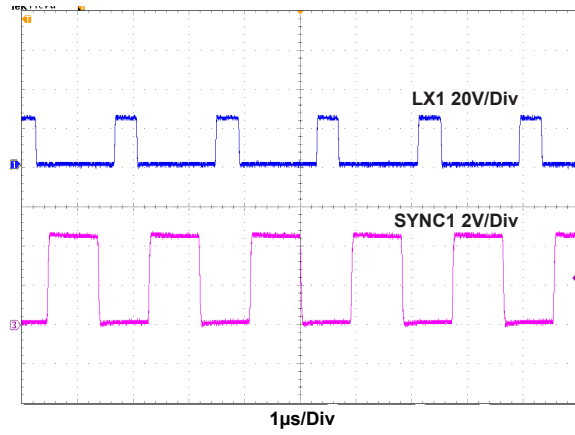

Figure 35. Sync at 550kHz, 1.1A Load

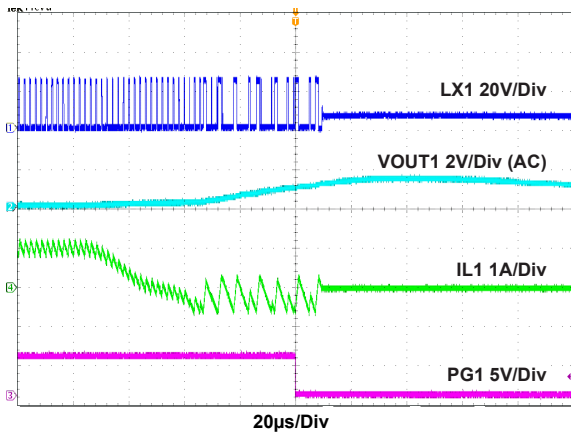

Figure 36. Negative Current Limit

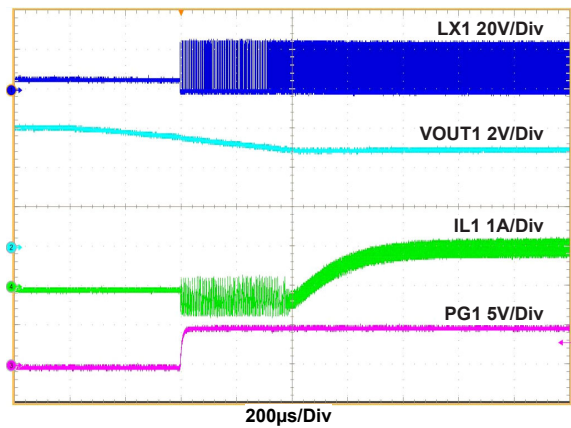

Figure 37. Negative Current Limit Recovery

Low  $V_{IN}$  Buck Measurements Unless otherwise noted:  $V_{IN2} = 5V$ ,  $V_{OUT2} = 1.2V$ ,  $C_{IN2} = C_{OUT2} = 2 \times 22\mu F$ ,  $T_J = +25^\circ C$ ,  $I_{LOAD} = 0A$

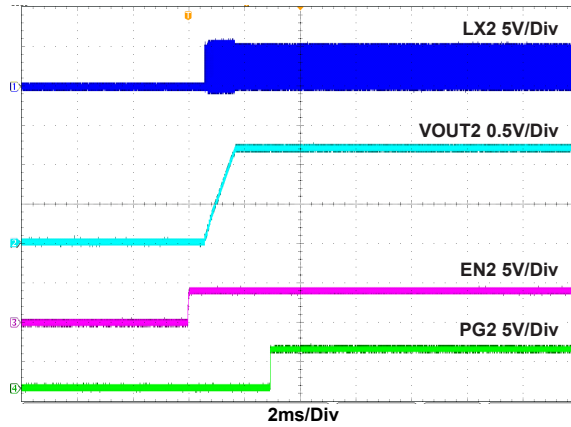

Figure 38. Start-Up by Enable at No Load,  $V_{IN2} = 5V$ ,  $T_A = +25^\circ C$

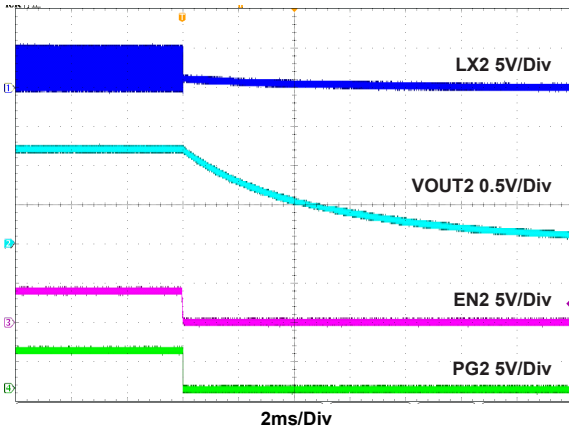

Figure 39. Shutdown by Enable at No Load,  $V_{IN2} = 5V$ ,  $T_A = +25^\circ C$

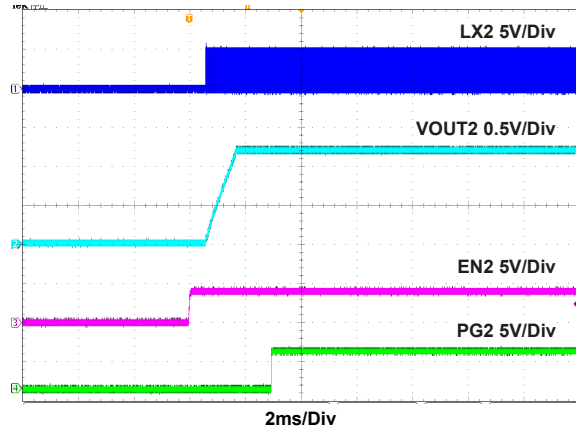

Figure 40. Start-Up by Enable at 1.5A Load,  $V_{IN2} = 5V$ ,  $T_A = +25^\circ C$

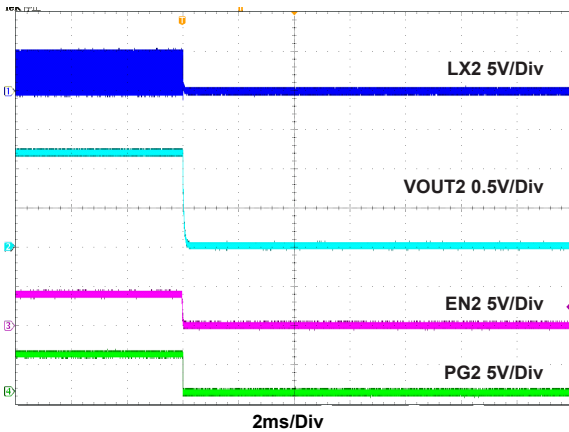

Figure 41. Shutdown by Enable at 1.5A Load,  $V_{IN2} = 5V$ ,  $T_A = +25^\circ C$

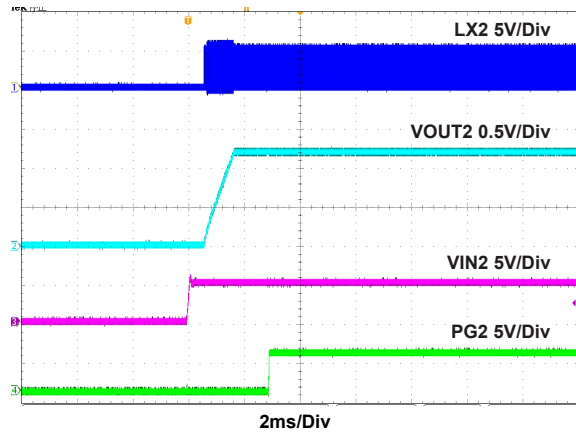

Figure 42. Start-Up by  $V_{IN2}$  at No Load,  $V_{IN2} = 5V$ ,  $T_A = +25^\circ C$

Low  $V_{IN}$  Buck Measurements Unless otherwise noted:  $V_{IN2} = 5V$ ,  $V_{OUT2} = 1.2V$ ,  $C_{IN2} = C_{OUT2} = 2 \times 22\mu F$ ,  $T_J = +25^\circ C$ ,  $I_{LOAD} = 0A$

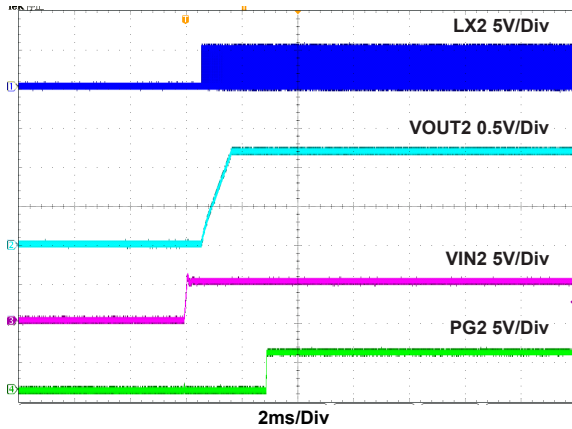

Figure 43. Start-Up by  $V_{IN2}$  at 1.5A Load,  $V_{IN2} = 5V$ ,  $T_A = +25^\circ C$

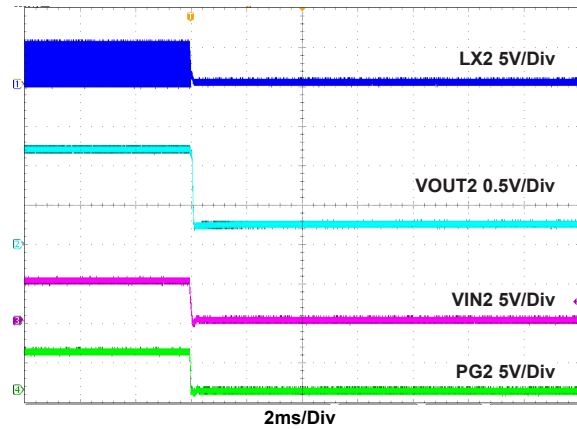

Figure 44. Shutdown by  $V_{IN2}$  at No Load,  $V_{IN2} = 5V$ ,  $T_A = +25^\circ C$

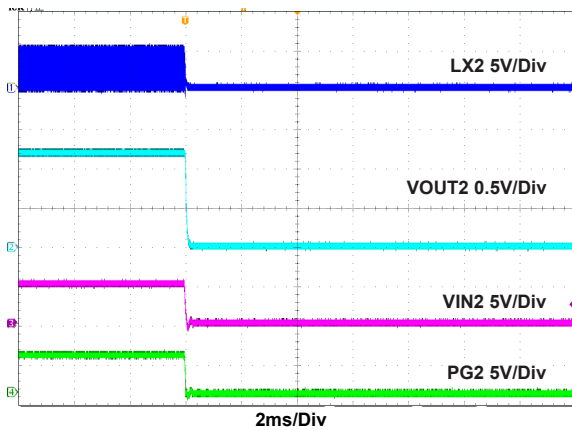

Figure 45. Shutdown by  $V_{IN2}$  at 1.5A Load,  $V_{IN2} = 5V$ ,  $T_A = +25^\circ C$

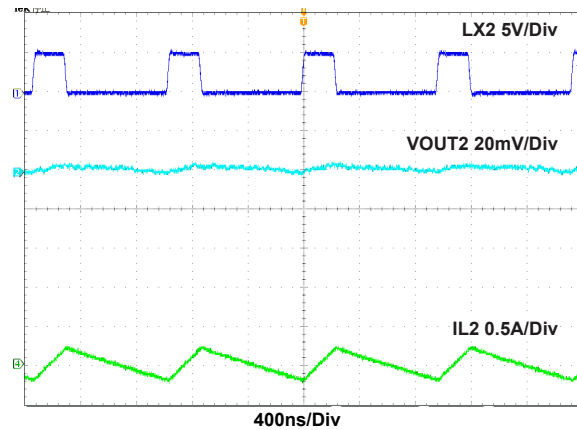

Figure 46. Steady State at No Load,  $V_{IN2} = 5V$ ,  $T_A = +25^\circ C$

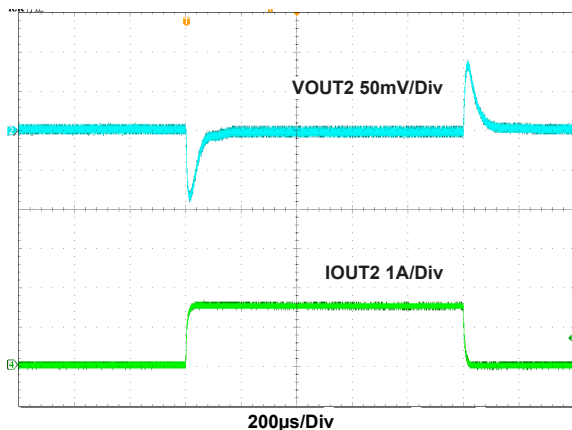

Figure 47. Load Transient,  $V_{IN2} = 5V$ ,  $T_A = +25^\circ C$

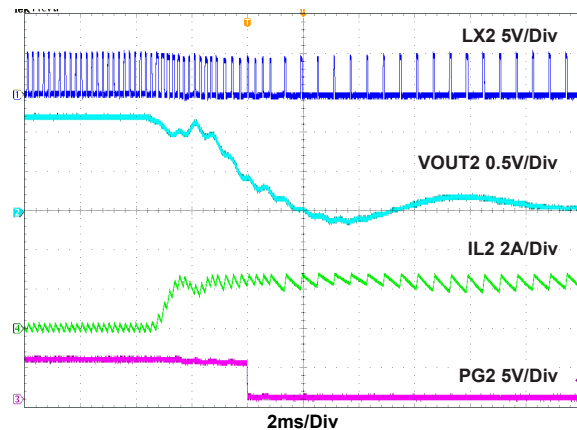

Figure 48. Output Short-Circuit,  $V_{IN2} = 5V$ ,  $T_A = +25^\circ C$

Low  $V_{IN}$  Buck Measurements Unless otherwise noted:  $V_{IN2} = 5V$ ,  $V_{OUT2} = 1.2V$ ,  $C_{IN2} = C_{OUT2} = 2 \times 22\mu F$ ,  $T_J = +25^\circ C$ ,  $I_{LOAD} = 0A$

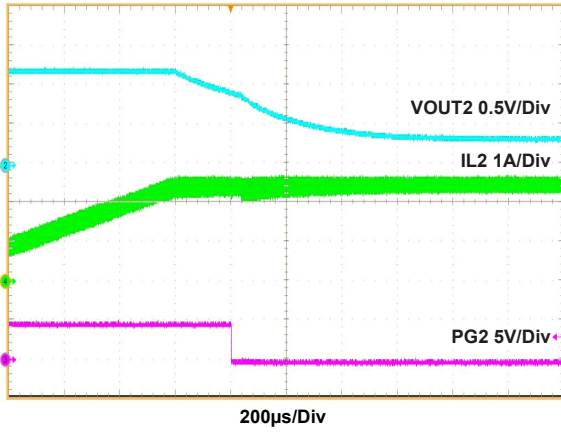

Figure 49. Overcurrent Protection,  $V_{IN2} = 5V$ ,  $T_A = +25^\circ C$

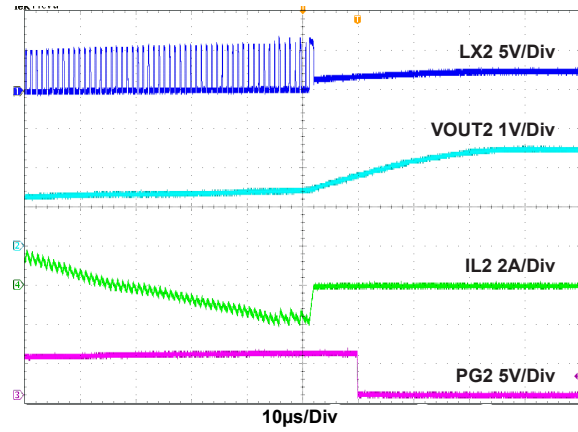

Figure 50. Overvoltage Protection,  $V_{IN2} = 5V$ ,  $T_A = +25^\circ C$

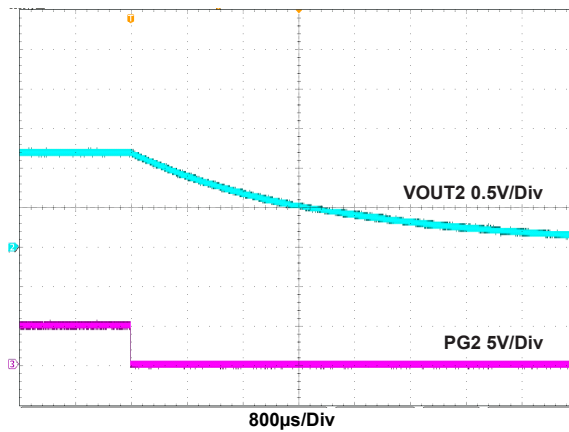

Figure 51. Over-Temperature Protection,  $V_{IN2} = 5V$ ,  $T_A = +160^\circ C$

## 4. Detailed Description

The RAA212422 consists of a constant frequency current mode wide  $V_{IN}$  buck regulator and a low  $V_{IN}$  buck regulator.

The wide  $V_{IN}$  buck regulator can operate from an unregulated DC source, such as a battery, with a voltage ranging from +3V to +40V. An internal linear regulator provides bias to the low voltage portions of the wide  $V_{IN}$  buck regulator. Peak current mode control simplifies feedback loop compensation and rejects input voltage variation.

User-selectable internal feedback loop compensation further simplifies design. The buck regulator is equipped with an internal current sensing circuit and the peak current limit threshold is typically set at 1.6A.

The low  $V_{IN}$  switching regulator operates at 1MHz switching frequency, which enables the use of smaller inductors resulting in small form factor while also providing excellent efficiency. The supply current is typically only 2 $\mu$ A when the regulator is shut down.

### 4.1 Power-On Reset /UVLO

The wide  $V_{IN}$  buck regulator automatically initializes after receiving the input power supply and continually monitors the EN1 pin state. If EN1 is held below its logic rising threshold, the IC is held in shutdown and consumes typically 2 $\mu$ A from the  $V_{IN1}$  supply. If EN1 exceeds its logic rising threshold, the regulator enables the bias linear regulator and begins to monitor the VCC1 pin voltage. When the VCC1 pin voltage passes its rising POR threshold, the controller initializes the switching regulator circuits. If  $V_{CC1}$  never passes the rising POR threshold, the controller does not allow the switching regulator to operate. If  $V_{CC1}$  falls below its falling POR threshold while the switching regulator is operating, the switching regulator shuts down until  $V_{CC1}$  returns.

When the low  $V_{IN}$  buck regulator's input voltage rises above a typical value of 2.5V, the regulator is allowed to turn on. When the input voltage falls below the Undervoltage Lockout (UVLO) threshold, the regulator is disabled.

### 4.2 Soft-Start (Wide $V_{IN}$ and Low $V_{IN}$ Buck)

Both the wide  $V_{IN}$  and low  $V_{IN}$  buck converters feature soft-start to avoid large inrush current.

For the buck converters,  $V_{OUT1}$  ( $V_{OUT2}$ ) is slowly increased at start-up to its final regulated value.

For the wide  $V_{IN}$  buck regulator, soft-start time is determined by the SS1 pin connection. If SS1 is pulled to VCC1, an internal 2ms timer is selected for soft-start. For other soft-start times, connect a capacitor from SS1 to GND. In this case, a 5.5 $\mu$ A current pulls up the SS1 voltage and the FB1 pin follows this ramp until it reaches the 600mV reference level. The wide  $V_{IN}$  buck regulator soft-start time is described by [Equation 1](#):

$$(EQ. 1) \quad \text{Time(ms)} = C(\text{nF}) \cdot 0.109$$

For the low  $V_{IN}$  buck regulator, when the VIN2 pin exceeds its rising POR trip point (nominal 2.5V), the device begins operation. If the EN2 pin is held low externally, nothing happens until this pin is released. When EN2 is released and is above the logic threshold, the internal default soft-start time is 1ms. The typical soft-start time for the low  $V_{IN}$  buck regulator is 1ms.

### 4.3 Power-Good

PG1 is the open-drain output of a window comparator that continuously monitors the wide  $V_{IN}$  buck regulator output voltage using the FB1 pin. PG1 is actively held low when EN1 is low and during the buck regulator soft-start period. After the soft-start period completes, PG1 becomes high impedance if the FB1 pin is within the range specified in the "Electrical Specifications" on [page 9](#). If FB1 exits the specified window, PG1 is pulled low until FB1 returns. Over-temperature faults also force PG1 low until the fault condition is cleared by an attempt to soft-start. An internal 5M $\Omega$  pull-up resistor is on the PG1 pin.

The window comparator output, PG2, continuously monitors the low  $V_{IN}$  buck regulator output voltage. PG2 is actively held low when EN2 is low and during the buck regulator soft-start period. After 1ms delay of the soft-start period, PG2 becomes high impedance as long as the output voltage is within nominal regulation voltage set by VFB2. When VFB2 drops 15% below or raises 15% above the nominal regulation voltage, the device pulls PG2 low. Any fault condition forces PG2 low until the fault condition is cleared by attempts to soft-start. An internal

5M $\Omega$  pull-up resistor is on the PG2 pin. You can add an external resistor from PG2 to VIN2 for more pull-up strength.

#### 4.4 PWM Control Scheme (Wide $V_{IN}$ and Low $V_{IN}$ Buck)

Both the wide  $V_{IN}$  and low  $V_{IN}$  buck regulators employ peak current-mode Pulse-Width Modulation (PWM) control for fast transient response and pulse-by-pulse current limiting, as shown in [Figure 5 on page 5](#). The current loop consists of the current-sensing circuit, slope compensation ramp, PWM comparator, oscillator, and latch. The current sense gain for the wide  $V_{IN}$  buck regulator is typically 500mV/A and the slope compensation rate, Se1, is typically 450mV/T, where T is the switching cycle period. The current sense gain for the low  $V_{IN}$  buck regulator is typically 300mV/A and the slope compensation rate, Se2, is typically 900mV/ $\mu$ s. The control reference for the current loop comes from the error amplifier's output ( $V_{COMP1}$  for wide  $V_{IN}$  and  $V_{COMP2}$  for low  $V_{IN}$  buck regulator).

A PWM cycle begins when a clock pulse sets the PWM latch and the upper FET turns on. The current begins to ramp up in the upper FET and inductor. This current is sensed, converted to a voltage ( $V_{CSA}$ ), and summed with the slope compensation signal. This combined signal is compared to  $V_{COMP1}$  ( $V_{COMP2}$ ) and the latch is reset when the signal is equal to  $V_{COMP1}$  ( $V_{COMP2}$ ). Upon latch reset the upper FET turns off and the lower FET turns on, allowing current to ramp down in the inductor. The lower FET remains on until the clock initiates another PWM cycle.

[Figure 52](#) shows the typical operating waveforms during PWM operation. The dotted lines illustrate the sum of the current sense and slope compensation signal.

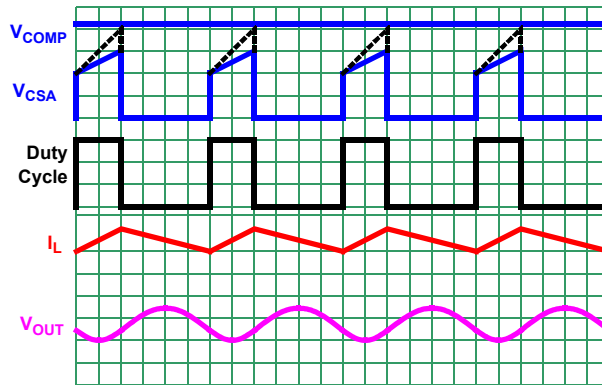

Figure 52. PWM Operation Waveforms

The output voltage is regulated as the error amplifier varies  $V_{COMP1}$  ( $V_{COMP2}$ ) and thus varies the output inductor current. The error amplifier is a transconductance type and its output (COMP1 or COMP2) is terminated with a series RC network to GND. This termination is internal (150k/54pF) if the COMP1 pin is tied to VCC1 for the wide  $V_{IN}$  buck. For the low  $V_{IN}$  buck, the termination is a 200k $\Omega$  and 27pF series R-C network. In addition, the transconductance for COMP1 = VCC1 is 50 $\mu$ A/V vs 230 $\mu$ A/V for external R-C connection. Its non-inverting input is internally connected to a 600mV reference voltage and its inverting input is connected to the output voltage using the FB1 pin and its associated divider network. The maximum error amplifier voltage of the low  $V_{IN}$  buck (COMP2) is clamped to 1.6V.

#### 4.5 Light Load Operation

At light loads, converter efficiency can be improved by enabling Pulsed Frequency Modulation (PFM). Connecting the SYNC1 pin to GND allows the controller to choose PFM operation automatically when the load current is low. [Figure 53 on page 23](#) shows the DCM operation. The IC enters the DCM mode of operation when eight consecutive cycles of inductor current crossing zero are detected. This corresponds to a load current equal to 1/2 the peak-to-peak inductor ripple current and set by [Equation 2](#):

$$(EQ. 2) \quad I_{OUT} = \frac{V_{OUT}(1-D)}{2Lf_{SW}}$$

where  $D$  = duty cycle,  $f_{SW}$  = switching frequency,  $L$  = inductor value,  $I_{OUT}$  = output loading current, and  $V_{OUT}$  = output voltage.

While operating in PFM mode, the regulator controls the output voltage with a simple comparator and pulsed FET current. A comparator signals the point where FB equals the 600mV reference, and the regulator begins providing pulses of current until FB moves above the 600mV reference by 1%. The current pulses are approximately 400mA and are issued at a frequency equal to the converter's programmed PWM operating frequency.

Due to the pulsed current nature of PFM mode, the converter can supply limited current to the load. If the load current rises beyond the limit,  $V_{OUT}$  begins to decline. A second comparator signals an FB voltage 2% lower than the 600mV reference and forces the converter to return to PWM operation.

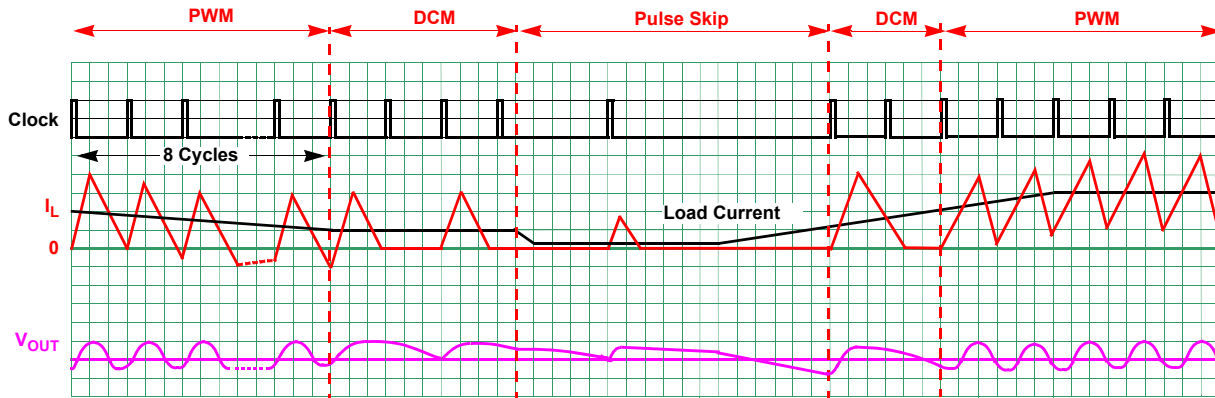

Figure 53. DCM Mode Operation Waveforms

### 4.6 Output Voltage Selection

The regulator output voltage is easily programmed using an external resistor divider to scale  $V_{OUT1}$  relative to the internal reference voltage. The scaled voltage is applied to the inverting input of the error amplifier; refer to [Figure 54](#) for more information.

The output voltage programming resistor,  $R_2$ , depends on the value chosen for the feedback resistor,  $R_1$ , and the needed output voltage,  $V_{OUT1}$ , of the regulator. [Equation 3](#) describes the relationship between  $V_{OUT1}$  and the resistor values.

$$(EQ. 3) \quad R_2 = \frac{R_1 \cdot 0.6V}{V_{OUT1} - 0.6V}$$

If the output voltage is 0.6V,  $R_2$  is left unpopulated and  $R_1$  is 0Ω.

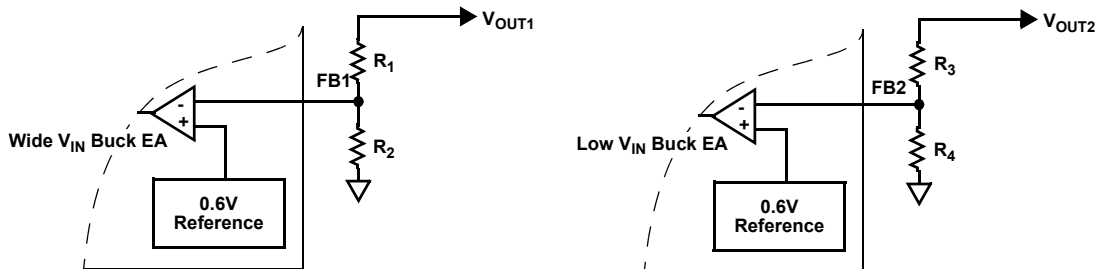

Figure 54. External Resistor Divider



Similarly, the output voltage of the low  $V_{IN}$  buck can be set by an external resistor divider network. Calculate the values of resistors  $R_3$  and  $R_4$  using [Equation 4](#).

$$(EQ. 4) \quad R_4 = \frac{R_3 \cdot 0.6V}{V_{OUT2} - 0.6V}$$

If the target output voltage is 0.6V,  $R_4$  is left unpopulated and  $R_3$  is shorted. There is a leakage current from  $V_{IN2}$  to LX2. Renesas recommends preloading the output with 10 $\mu$ A minimum. For better performance, add a feedforward capacitor in parallel with  $R_1$ . Check loop analysis before use in an application.

## 4.7 Protection Features

The RAA212422 is protected from overcurrent, negative overcurrent, over-temperature, and boot undervoltage. The protection circuits operate automatically.

### 4.7.1 Overcurrent Protection

During PWM on-time of the wide  $V_{IN}$  buck regulator, current through the upper FET is monitored and compared to a nominal 1.6A peak overcurrent limit. If the current reaches the limit, the upper FET turns off until the next switching cycle. In this way, FET peak current is always well limited.

If the overcurrent condition persists for typically 17 sequential clock cycles, the regulator begins its hiccup sequence. In this case, both FETs turn off and PG1 is pulled low. This condition is maintained for eight soft-start periods, after which the regulator attempts a normal soft-start.

If the output fault persists, the regulator repeats the hiccup sequence indefinitely. Output faults are not dangerous even if the output is shorted during soft-start.

If  $V_{OUT1}$  is shorted very quickly, FB1 may collapse below 5/8 of its target value before the typical 17 cycles of overcurrent are detected. The RAA212422 recognizes this condition and begins to lower its switching frequency proportional to the FB1 pin voltage. This ensures that the current never runs away (even with  $V_{OUT1}$  near 0V).

The low  $V_{IN}$  buck regulator is protected from overcurrent by monitoring the CSA output with the OCP comparator, as shown in the [Figure 5 on page 5](#). The current-sensing circuit has a gain of 300mV/A from the P-FET current to the CSA output. When the CSA output reaches a threshold, the OCP comparator is tripped to turn off the P-FET immediately. The overcurrent function protects the switching converter from a shorted output by monitoring the current flowing through the upper MOSFET.

Upon detection of an overcurrent condition, the upper MOSFET immediately turns off and does not turn on again until the next switching cycle. If the overcurrent condition stops, the output resumes back into regulation point.

### 4.7.2 Short-Circuit Protection (Low $V_{IN}$ Buck)

The low  $V_{IN}$  buck regulator Short-Circuit Protection (SCP) comparator monitors the VFB2 pin voltage for output short-circuit faults. When the VFB2 voltage is lower than 0.3V, the SCP comparator forces the PWM oscillator frequency to drop below the normal operation value. This comparator is effective during startup or an output short-circuit event.

### 4.7.3 Negative Current Limit

For the wide  $V_{IN}$  buck regulator, if an external source drives current into  $V_{OUT1}$ , the controller attempts to regulate  $V_{OUT1}$  by reversing its inductor current to absorb the externally sourced current. If the external source is low impedance, the current may be reversed to unacceptable levels and the controller initiates its negative current limit protection. Similar to normal overcurrent, negative current protection is enabled by monitoring the current through the lower FET. When the valley point of the inductor current reaches negative current limit, the lower FET is turned off and the upper FET is forced on until current reaches the positive current limit or an internal clock signal is issued. At this point, the lower FET is allowed to operate. If the current is again pulled to the negative limit on the next cycle, the upper FET is forced on and the current is forced to 1/6 of the positive



current limit. At this point, the controller turns off both FETs and waits for COMP1 to indicate return to normal operation. During this time, the controller applies a 100Ω load from LX1 to PGND and attempt to discharge the output. Negative current limit is a pulse-by-pulse style operation and recovery is automatic.

For the low  $V_{IN}$  buck regulator, similar to the overcurrent, the negative current protection is enabled by monitoring the current across the low-side N-FET, as shown in [Figure 5 on page 5](#). When the valley point of the inductor current reaches -1.5A for two consecutive cycles, both P-FET and N-FET shut off. The 100Ω in parallel to the N-FET activates discharging the output into regulation. The control begins to switch when output is within regulation.

#### 4.7.4 Over-Temperature Protection

Over-temperature protection limits the maximum junction temperature of both the wide  $V_{IN}$  and low  $V_{IN}$  buck regulators in the RAA212422. When the junction temperature ( $T_J$ ) of the wide  $V_{IN}$  buck converter exceeds +150°C, both FETs are turned off and the controller waits for the temperature to decrease by approximately 25°C. During this time PG1 is pulled low. When the temperature is within an acceptable range, the controller initiates a normal soft-start sequence. For continuous operation, do not exceed the +125°C junction temperature rating.

For the low  $V_{IN}$  buck regulator, when the internal temperature reaches +150°C, the regulator is completely shut down. As the temperature drops by 25°C, the device resumes operation by stepping through the soft-start.

#### 4.7.5 Boot Undervoltage Protection (Wide $V_{IN}$ Buck)

During PWM operation near dropout ( $V_{IN1}$  near  $V_{OUT1}$ ), the regulator may hold the upper FET on for multiple clock cycles. To prevent the boot capacitor from discharging, the lower FET is forced on for approximately 200ns every 10 clock cycles.

If the boot capacitor voltage falls below 1.8V, the boot undervoltage protection circuit turns on the lower FET for 400ns to recharge the capacitor. This operation can arise during long periods of no switching, such as PFM no load situations.

### 4.8 Discharge Mode/Soft-Stop (Low $V_{IN}$ Buck)

When a transition to shutdown mode occurs or the  $V_{IN}$  UVLO is set, the output discharges to GND through an internal 100Ω switch.

### 4.9 100% Duty Cycle (Low $V_{IN}$ Buck)

The RAA212422 features 100% duty cycle operation to maximize the battery life. When the battery voltage drops to a level at which the device can no longer maintain the regulation at the output, the regulator completely turns on the P-FET. The maximum dropout voltage under the 100% duty cycle operation is the product of the load current and the ON-resistance of the P-FET.

### 4.10 Power Derating Characteristics

To prevent the buck regulators from exceeding the maximum junction temperature, some thermal analysis is required. The temperature rise is given by [Equation 5](#):

$$(EQ. 5) \quad T_{RISE} = (PD)(\theta_{JA})$$

where PD is the power dissipated by the regulator and  $\theta_{JA}$  is the thermal resistance from the junction of the die to the ambient temperature. The junction temperature,  $T_J$ , is given by [Equation 6](#):

$$(EQ. 6) \quad T_J = (T_A + T_{RISE})$$

where  $T_A$  is the ambient temperature.

The actual junction temperature should not exceed the absolute maximum junction temperature of +125°C when considering the thermal design.

## 5. Application Guidelines

### 5.1 Simplifying the Design

Although the wide  $V_{IN}$  buck converter of RAA212422 offers user programmed options for most parameters, the easiest implementation with fewest components involves selecting internal settings for SS1, COMP1, and FS1.

The low  $V_{IN}$  buck converter offers both internal and external compensation options. [Tables 1 and 2 on page 4](#) provide component value selections for a variety of output voltages for the wide  $V_{IN}$  and low  $V_{IN}$  buck regulators and allow the designer to implement solutions with minimal effort. X5R or X7R ceramic capacitors are recommended for small solution size and low profile designs.

### 5.2 Operating Frequency (Wide $V_{IN}$ Buck)

The RAA212422 wide  $V_{IN}$  buck converter operates at a default switching frequency of 500kHz if the FS1 pin is tied to VCC1. Tie a resistor from the FS1 pin to GND to program the switching frequency from 300kHz to 2MHz, as shown in [Equation 7](#).

$$(EQ. 7) \quad R_{FS1}[k\Omega] = 108.75k\Omega \cdot (t - 0.2\mu s) / (1\mu s)$$

where:

t is the switching period in  $\mu s$

[Figure 55](#) shows the desired switching frequency and its corresponding  $R_{FS1}$ .

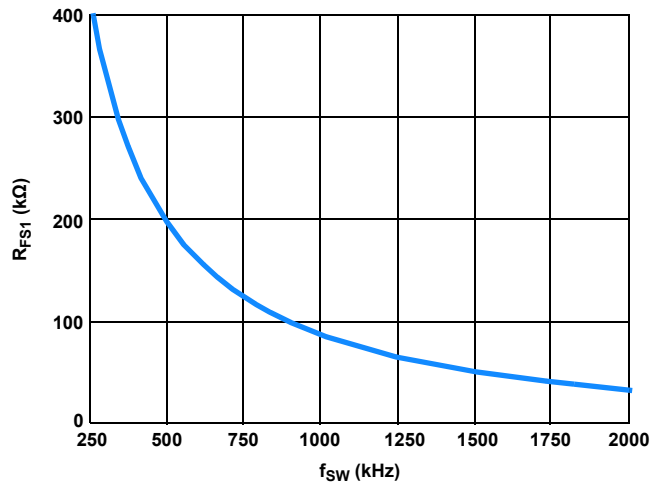

Figure 55. R<sub>FS1</sub> Selection vs f<sub>SW</sub>

### 5.3 Minimum On/Off-Time Limitation

Minimum on-time ( $t_{MIN\_ON}$ ) is the shortest duration of time that the HS FET can be turned on and minimum off time ( $t_{MIN\_OFF}$ ) is the shortest duration of time that the HS FET can be turned off. The typical  $t_{MIN\_ON}$  is 90ns and the typical  $t_{MIN\_OFF}$  is 150ns. For a given  $t_{MIN\_ON}$  and  $t_{MIN\_OFF}$ , a higher switching frequency results in a narrower range of allowed duty cycle, which translates to a smaller allowed  $V_{IN}$  range.

For a given output voltage ( $V_{OUT}$ ) and switching frequency ( $f_{SW}$ ), the maximum allowed voltage is given by [\(Equation 8\)](#):

$$(EQ. 8) \quad V_{IN(max)} = \frac{V_{OUT}}{f_{SW} \times t_{MIN\_ON}}$$

The minimum allowed voltage is given by ([Equation 9](#)):

$$(EQ. 9) \quad V_{IN(min)} = \frac{V_{OUT}}{1 - f_{SW} \times t_{MIN\_OFF}}$$

[Table 3](#) shows the recommended switching frequencies for the various  $V_{OUT}$  to operate up to the maximum  $V_{IN}$  (40V).

**Table 3. Recommended Switching Frequencies for Various  $V_{OUT}$**

$V_{IN(max)}$ (V)	$V_{OUT}$ (V)	$f_{SW}$ (kHz)
40	5	500
40	3.3	500
40	2.5	500
40	1.8	300

#### 5.4 Synchronization Control (Wide $V_{IN}$ Buck)

The wide  $V_{IN}$  buck converter operation frequency can be synchronized up to 2MHz by an external signal applied to the SYNC1 pin. The rising edge on the SYNC1 triggers the rising edge of LX1. To properly synchronize, the external source must be at least 10% greater than the programmed free running IC frequency.

#### 5.5 Output Inductor Selection

The inductor value determines the converter's ripple current. A reasonable starting point for choosing the ripple current,  $\Delta I$ , is 30% of the total load current. You can calculate the inductor value using [Equation 10](#):

$$(EQ. 10) \quad L = \frac{V_{IN} - V_{OUT}}{f_{SW} \times \Delta I} \cdot \frac{V_{OUT}}{V_{IN}}$$

As an example, using  $V_{IN1} = 24V$ ,  $V_{OUT1} = 5V$ ,  $f_{sw} = 500kHz$ ,  $I_{OUT1} = 1.1A$ , and  $\Delta i/I_{OUT1} = 30\%$ , the inductance is calculated as follows:

$$(EQ. 11) \quad L_1 = \frac{24V - 5V}{500kHz \times 0.3 \times 1.1A} \cdot \frac{5V}{24V} = 24\mu H$$

Choose a standard inductance value of 22 $\mu$ H.

Increasing the inductance value reduces the ripple current and thus the ripple voltage. However, the larger inductance value may reduce the converter's response time to a load transient. The inductor current rating should be such that it does not saturate in overcurrent conditions. For typical RAA212422 applications, inductor values are generally in the 10 $\mu$ H to 47 $\mu$ H range for the wide  $V_{IN}$  buck regulator and 1 $\mu$ H to 2.2 $\mu$ H for the low  $V_{IN}$  buck regulator. Generally, higher  $V_{OUT}$  requires higher inductance.

#### 5.6 Input Capacitor Selection

The main functions for the input capacitor are to provide decoupling of the parasitic inductance and a filtering function to prevent the switching current from flowing back to the battery rail. A good starting point for input capacitor selection is to use at least two 10 $\mu$ F for the wide  $V_{IN}$  buck regulator and at least two 22 $\mu$ F for the low  $V_{IN}$  buck regulator, X5R or X7R ceramic capacitors.

#### 5.7 Output Capacitor Selection

An output capacitor is required to filter the inductor current. Output ripple voltage and transient response are two critical factors when considering an output capacitance choice. The current mode control loop allows the use of low ESR ceramic capacitors and enables small solution size on the PCB. You can also use electrolytic and polymer capacitors.

Although ceramic capacitors offer excellent overall performance and reliability, the actual in-circuit capacitance must be considered. Ceramic capacitors are rated using large peak-to-peak voltage swings and with no DC bias. In DC/DC converter applications, these conditions do not reflect reality. As a result, the actual capacitance may be considerably lower than the advertised value. Consult the manufacturer’s datasheet to determine the actual in-application capacitance. Most manufacturers publish capacitance vs DC bias so that this effect can be easily accommodated. The effects of AC voltage are not frequently published. The result of these considerations may require an effective capacitance much lower than nominal and this value should be used in all design calculations. However, ceramic capacitors are a very good choice in many applications due to their reliability and extremely low ESR.

Use [Equation 12](#) to calculate the required capacitance to meet the ripple voltage level. Additional capacitance can be used.

$$(EQ. 12) \quad V_{OUTripplle} = \left( \frac{\Delta I}{8 \cdot f_{SW} \cdot C_{OUT}} + \Delta I \cdot ESR + \frac{ESL \cdot V_{IN}}{L} \right)$$

where:

- $\Delta I$  is the inductor’s peak-to-peak ripple current
- $f_{SW}$  is the switching frequency
- $C_{OUT}$  is the output capacitor
- ESR is the equivalent series resistance of the output capacitor
- ESL is the equivalent series inductance of the output capacitor
- L is the output filter inductance

### 5.8 Loop Compensation Design

When COMP1 is not connected to VCC1, the COMP1 pin is active for external loop compensation. The RAA212422 buck converter uses constant frequency peak current mode control architecture to achieve a fast loop transient response. An accurate current sensing pilot device in parallel with the upper MOSFET is used for peak current control signal and overcurrent protection. The inductor is not considered a state variable because its peak current is constant and the system becomes a single order system. It is much easier to design a Type II compensator to stabilize the loop than to implement voltage mode control. Peak current mode control has an inherent input voltage feed-forward function to achieve good line regulation. [Figure 56](#) shows the small signal model of the synchronous buck regulator.

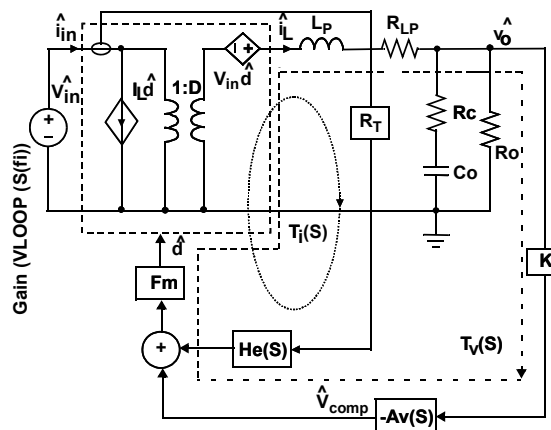
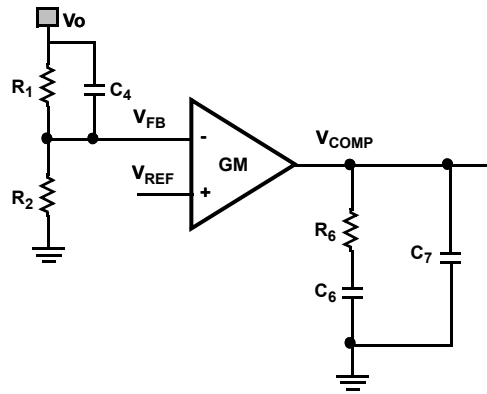

Figure 56. Small Signal Model of Synchronous Buck Regulator



**Figure 57. Type II Compensator**

Figure 57 shows the Type II compensator and its transfer function is expressed as shown in Equation 13:

$$(EQ. 13) \quad A_v(s) = \frac{\hat{V}_{COMP}}{V_{FB}} = \frac{GM \cdot R_2}{(C_6 + C_7) \cdot (R_1 + R_2)} \frac{\left(1 + \frac{s}{\omega_{cz1}}\right)\left(1 + \frac{s}{\omega_{cz2}}\right)}{s\left(1 + \frac{s}{\omega_{cp1}}\right)\left(1 + \frac{s}{\omega_{cp2}}\right)}$$

where

$$\omega_{cz1} = \frac{1}{R_6 C_6}, \quad \omega_{cz2} = \frac{1}{R_1 C_4}, \quad \omega_{cp1} = \frac{C_6 + C_7}{R_6 C_6 C_7}, \quad \omega_{cp2} = \frac{R_1 + R_2}{C_4 R_1 R_2}$$

Compensator design goal:

- High DC gain
- Choose loop bandwidth  $f_c$  less than 100kHz
- Gain margin: >10dB
- Phase margin: >40°

The compensator design procedure is as follows:

The loop gain at crossover frequency of  $f_c$  has a unity gain; therefore, the compensator resistance  $R_6$  is determined by Equation 14.

$$(EQ. 14) \quad R_6 = \frac{2\pi f_c V_o C_o R_{cs} k}{GM \cdot V_{FB}} = k_1 \cdot f_c V_o C_o$$

where:

- GM is the transconductance,  $g_m$ , of the voltage error amplifier in each phase
- $R_{cs}$  is the current sense trans-resistance
- k is a constant to compensate for cross over frequency difference because the feed forward zero is placed at the vicinity of  $f_c$
- $k_1$  is a constant that depends on the internal parameters of the buck converter. For the wide  $V_{IN}$  buck regulator,  $k_1$  is  $16.1 \times 10^3$ . For the low  $V_{IN}$  buck regulator,  $k_1$  is  $13.9 \times 10^3$

Place the compensator zero in the vicinity of the power stage pole at full load. As an example, the compensator zero is placed at twice the frequency of the power stage pole at full load. Compensator capacitor  $C_6$  is then given by [Equation 15](#).

$$(EQ. 15) \quad C_6 = \frac{R_o C_o}{2R_6} = \frac{V_o C_o}{2I_o R_6}$$

An inherent integrator pole at DC by virtue of the compensation circuit helps to achieve high DC gain. Place another compensator pole at either ESR zero frequency or half switching frequency, whichever is lower, in [Equation 16](#). An optional zero can boost the phase margin.  $\omega_{CZ2}$  is a zero due to  $R_1$  and  $C_4$ .

$$(EQ. 16) \quad C_7 = \max\left(\frac{R_c C_o}{R_6}, \frac{1}{\pi f_{SW} R_6}\right)$$

Put feedforward zero at  $f_{zff}$  to boost the phase at cross-over. The  $f_{zff}$  can be chosen in the vicinity of  $f_c$  depending on the amount of phase boost required.

$$(EQ. 17) \quad C_4 = \frac{1}{2\pi f_{zff} R_1}$$

Example 1: If  $V_{IN1} = 24V$ ,  $V_{O1} = 5V$ ,  $I_{O1} = 1.1A$ ,  $f_{SW} = 500kHz$ ,  $R_2 = 90.9k\Omega$ ,  $C_{o1} = 32.1\mu F/5m\Omega$ ,  $L_1 = 22\mu H$ , and  $f_c = 50kHz$ , compensator resistance  $R_6$ :

$$(EQ. 18) \quad R_6 = 16.1 \times 10^3 \cdot 50kHz \cdot 5V \cdot 32.1\mu F = 129.3k\Omega$$

Use 130k $\Omega$  as the closest standard value for  $R_6$ .

$$(EQ. 19) \quad C_6 = \frac{5V \cdot 32.1\mu F}{1.1A \cdot 130k\Omega \cdot 2} = 0.497nF$$

$$(EQ. 20) \quad C_7 = \max\left(\frac{5m\Omega \cdot 32.1\mu F}{130k\Omega}, \frac{1}{\pi \cdot 500kHz \cdot 130k\Omega}\right) = (1.2pF, 4.9pF)$$

There is approximately 3pF parasitic capacitance from  $V_{COMP1}$  to GND; Therefore,  $C_7$  is optional. Use  $C_6 = 470pF$  and  $C_7 = \text{Open}$ . Choose  $f_{zff}$  to be  $1.5 \times f_c$ .

$$(EQ. 21) \quad C_4 = \frac{1}{2\pi \cdot 50kHz \cdot 1.5 \cdot 90.9k\Omega} = 23.3pF$$

Use  $C_4 = 22pF$ . [Figure 58 on page 31](#) shows the simulated voltage loop gain, which has a 44kHz loop bandwidth with an 84° phase margin and 21dB gain margin. In the above example, 22 $\mu F$ +47 $\mu F$  1206 case size ceramic capacitors are used. The effective output capacitance after voltage derating is 32.1 $\mu F$ . In practice, ceramic capacitors have significant derating on voltage and temperature, depending on the type. Refer to the ceramic capacitor datasheet for more details.

The previous description is one of the methodologies to design the compensation network and can be used as a general guideline. However, it is not the only way to choose compensation components. The optimal compensation components may vary depending on your requirements.

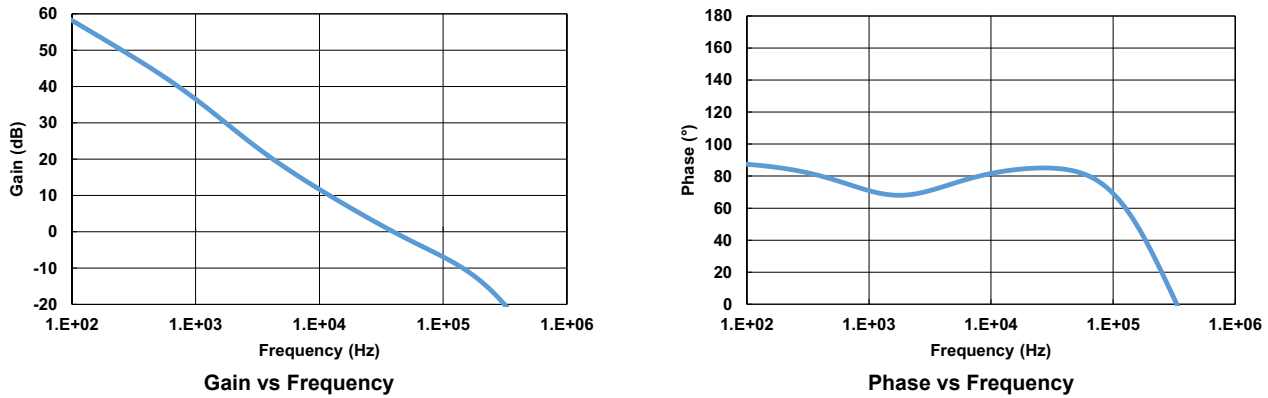

Figure 58. Simulated Loop Gain

Example 2:  $V_{IN2} = 5V$ ,  $V_{O2} = 1.2V$ ,  $I_{O2} = 1.5A$ ,  $f_{SW} = 1MHz$ ,  $R_1 = R_2 = 100k\Omega$ ,  $C_{o1} = 44.6\mu F/5m\Omega$ ,  $L_1 = 2.2\mu H$ ,  $f_c = 80kHz$ , then compensator resistance  $R_6$ :

$$(EQ. 22) \quad R_6 = 13.9 \times 10^3 \cdot 80kHz \cdot 1.2V \cdot 44.6\mu F = 59.5k\Omega$$

Use  $60k\Omega$  as the closest standard value for  $R_6$ .

$$(EQ. 23) \quad C_6 = \frac{1.2V \cdot 44.6\mu F}{1.5A \cdot 60k\Omega \times 2} = 297pF$$

$$(EQ. 24) \quad C_7 = \max\left(\frac{5m\Omega \cdot 44.6\mu F}{60k\Omega}, \frac{1}{\pi \cdot 1MHz \cdot 60k\Omega}\right) = (3.7pF, 5.3pF)$$

There is approximately 3pF parasitic capacitance from  $V_{COMP1}$  to GND; Therefore,  $C_7$  is optional. Use  $C_6 = 270pF$  and  $C_7 = OPEN$ . Choose  $f_{zff}$  to be at  $f_c$ .

$$(EQ. 25) \quad C_4 = \frac{1}{2\pi \cdot 80kHz \cdot 100k\Omega} = 20pF$$

Use  $C_4 = 22pF$ . [Figure 59](#) shows the simulated voltage loop gain. It shows that it has a 81kHz loop bandwidth with a 62° phase margin and 22dB gain margin.

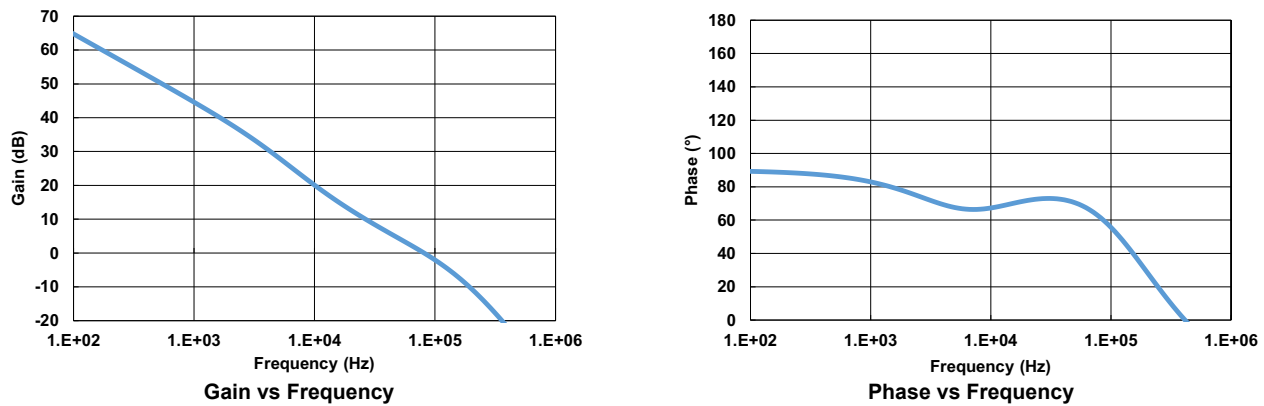

Figure 59. Simulated Loop Gain

## 6. Layout Suggestions

Proper layout of the power converter minimizes EMI and noise, and ensure first pass success of the design. Follow these layout guidelines to help optimize the design.

- (1) Place the input ceramic capacitors as close as possible to the IC VIN pin and power ground. Keep this loop (input ceramic capacitor, IC VIN pin, and power ground) as small as possible to reduce the trace parasitic inductance and hence reduce voltage spikes.
- (2) Place the input aluminum bulk capacitor close to the input ceramic capacitors.
- (3) Keep the phase node copper area small, but large enough to handle the load current.
- (4) Place the output capacitors close to the power stage components.
- (5) Place vias at the bottom pad of the IC. Place the bottom pad in a ground copper plane with an area as large as possible in multiple layers for better heat dissipation and removal.
- (6) One of the most critical connections is to connect the GND pin to the package GND pad. Use vias to directly connect the GND pad to the system GND plane. This connection ensures a low impedance path for all return current and an excellent thermal path to dissipate heat.
- (7) Place the 1 $\mu$ F ceramic decoupling capacitor at the VCC1 pin (the closest place to the IC). Place vias close to the ground pad of this capacitor.
- (8) Keep the bootstrap capacitor close to the IC.
- (9) Place the feedback divider close to the FB1 pin and do not route any feedback components near LX1 or BOOT1. If external components are used for SS1, COMP1, or FS1, the same advice applies.
- (10) Similarly, for the low  $V_{IN}$  buck regulator, place the feedback divider close to the FB2 pin and do not route any feedback components near LX2. If external components are used for COMP2, the same advice applies.
- (11) Connect the EPAD to the ground plane with low-thermal resistance vias.
- (12) Connect GND1, GND2, and EPAD to the ground plane.



## 7. Revision History

Rev.	Date	Description
1.00	Jul 8, 2019	Updated Title Updated page 1 description. Updated Features section. Updated Figures 1, 2, and 5. Updated the title for Figures 12, 13, 20, and 22. Updated SYNC1 pin description. Added PFM Peak Current Limit spec on page 10. Updated "Typical Performance Curves". Added "Light Load Operation" on page 22. Updated Boot Undervoltage Protection (Buck) section. Added Minimum On/Off-Time Limitation section.
0.00	Nov 9, 2018	Initial release.

# 8. Package Outline Drawing

For the most recent package outline drawing, see [L22.3x6](#).

L22.3x6  
 22 Lead Thin Dual Flat No-Lead Plastic Package (TDFN)  
 Rev 0, 3/18

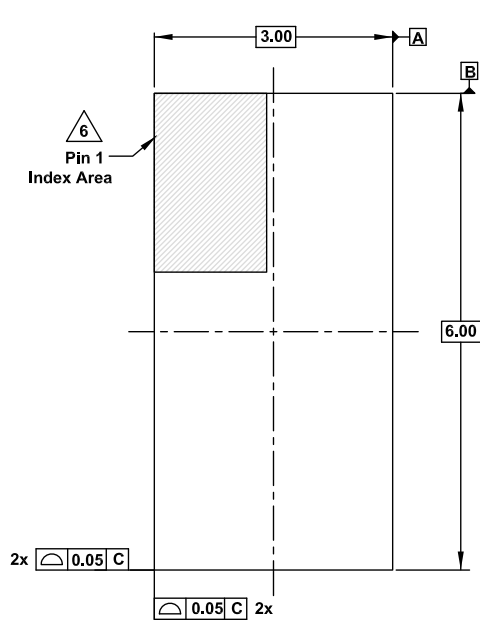

Top View

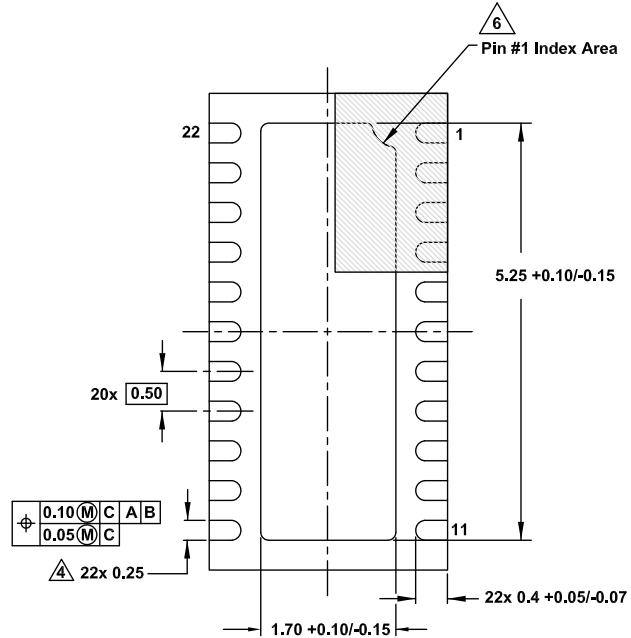

Bottom View

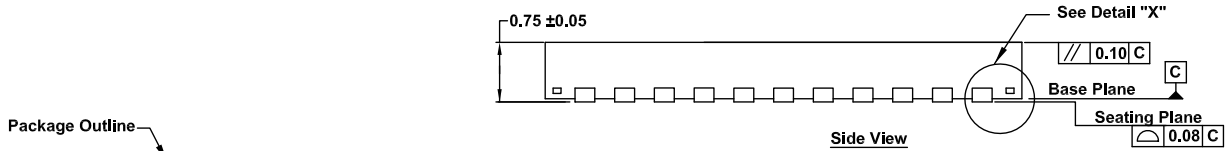

Side View

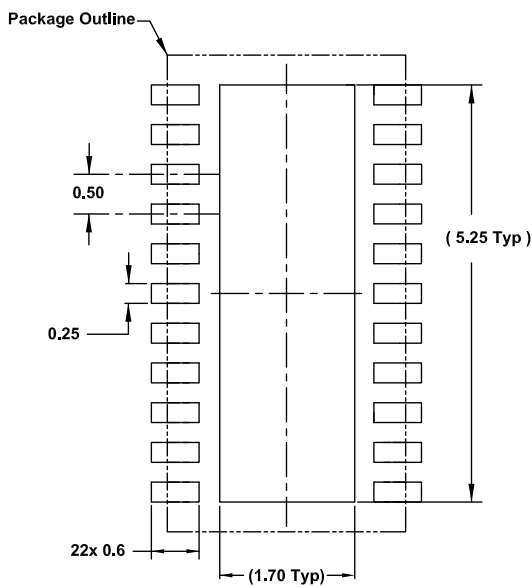

Typical Recommended Land Pattern

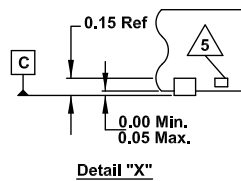

Detail "X"

Notes:

1. Dimensions are in millimeters.  
Dimensions in ( ) for reference only.
2. Dimensioning and tolerancing conform to AMSEY14.5m-1994.
3. Unless otherwise specified, tolerance : Decimal ±0.05
4. Dimension applies to the metallized terminal and is measured between 0.20mm and 0.30mm from the terminal tip.
5. Tiebar shown (if present) is a non-functional feature.
6. The configuration of the pin #1 identifier is optional, but must be located within the zone indicated. The pin #1 identifier may be either a mold or mark feature.

## Notice

1. Descriptions of circuits, software and other related information in this document are provided only to illustrate the operation of semiconductor products and application examples. You are fully responsible for the incorporation or any other use of the circuits, software, and information in the design of your product or system. Renesas Electronics disclaims any and all liability for any losses and damages incurred by you or third parties arising from the use of these circuits, software, or information.
  2. Renesas Electronics hereby expressly disclaims any warranties against and liability for infringement or any other claims involving patents, copyrights, or other intellectual property rights of third parties, by or arising from the use of Renesas Electronics products or technical information described in this document, including but not limited to, the product data, drawings, charts, programs, algorithms, and application examples.
  3. No license, express, implied or otherwise, is granted hereby under any patents, copyrights or other intellectual property rights of Renesas Electronics or others.
  4. You shall not alter, modify, copy, or reverse engineer any Renesas Electronics product, whether in whole or in part. Renesas Electronics disclaims any and all liability for any losses or damages incurred by you or third parties arising from such alteration, modification, copying or reverse engineering.
  5. Renesas Electronics products are classified according to the following two quality grades: "Standard" and "High Quality". The intended applications for each Renesas Electronics product depends on the product's quality grade, as indicated below.
    - "Standard": Computers; office equipment; communications equipment; test and measurement equipment; audio and visual equipment; home electronic appliances; machine tools; personal electronic equipment; industrial robots; etc.
    - "High Quality": Transportation equipment (automobiles, trains, ships, etc.); traffic control (traffic lights); large-scale communication equipment; key financial terminal systems; safety control equipment; etc.Unless expressly designated as a high reliability product or a product for harsh environments in a Renesas Electronics data sheet or other Renesas Electronics document, Renesas Electronics products are not intended or authorized for use in products or systems that may pose a direct threat to human life or bodily injury (artificial life support devices or systems; surgical implantations; etc.), or may cause serious property damage (space system; undersea repeaters; nuclear power control systems; aircraft control systems; key plant systems; military equipment; etc.). Renesas Electronics disclaims any and all liability for any damages or losses incurred by you or any third parties arising from the use of any Renesas Electronics product that is inconsistent with any Renesas Electronics data sheet, user's manual or other Renesas Electronics document.
  6. When using Renesas Electronics products, refer to the latest product information (data sheets, user's manuals, application notes, "General Notes for Handling and Using Semiconductor Devices" in the reliability handbook, etc.), and ensure that usage conditions are within the ranges specified by Renesas Electronics with respect to maximum ratings, operating power supply voltage range, heat dissipation characteristics, installation, etc. Renesas Electronics disclaims any and all liability for any malfunctions, failure or accident arising out of the use of Renesas Electronics products outside of such specified ranges.
  7. Although Renesas Electronics endeavors to improve the quality and reliability of Renesas Electronics products, semiconductor products have specific characteristics, such as the occurrence of failure at a certain rate and malfunctions under certain use conditions. Unless designated as a high reliability product or a product for harsh environments in a Renesas Electronics data sheet or other Renesas Electronics document, Renesas Electronics products are not subject to radiation resistance design. You are responsible for implementing safety measures to guard against the possibility of bodily injury, injury or damage caused by fire, and/or danger to the public in the event of a failure or malfunction of Renesas Electronics products, such as safety design for hardware and software, including but not limited to redundancy, fire control and malfunction prevention, appropriate treatment for aging degradation or any other appropriate measures. Because the evaluation of microcomputer software alone is very difficult and impractical, you are responsible for evaluating the safety of the final products or systems manufactured by you.
  8. Please contact a Renesas Electronics sales office for details as to environmental matters such as the environmental compatibility of each Renesas Electronics product. You are responsible for carefully and sufficiently investigating applicable laws and regulations that regulate the inclusion or use of controlled substances, including without limitation, the EU RoHS Directive, and using Renesas Electronics products in compliance with all these applicable laws and regulations. Renesas Electronics disclaims any and all liability for damages or losses occurring as a result of your noncompliance with applicable laws and regulations.
  9. Renesas Electronics products and technologies shall not be used for or incorporated into any products or systems whose manufacture, use, or sale is prohibited under any applicable domestic or foreign laws or regulations. You shall comply with any applicable export control laws and regulations promulgated and administered by the governments of any countries asserting jurisdiction over the parties or transactions.
  10. It is the responsibility of the buyer or distributor of Renesas Electronics products, or any other party who distributes, disposes of, or otherwise sells or transfers the product to a third party, to notify such third party in advance of the contents and conditions set forth in this document.
  11. This document shall not be reprinted, reproduced or duplicated in any form, in whole or in part, without prior written consent of Renesas Electronics.
  12. Please contact a Renesas Electronics sales office if you have any questions regarding the information contained in this document or Renesas Electronics products.
- (Note1) "Renesas Electronics" as used in this document means Renesas Electronics Corporation and also includes its directly or indirectly controlled subsidiaries.
- (Note2) "Renesas Electronics product(s)" means any product developed or manufactured by or for Renesas Electronics.

(Rev.4.0-1 November 2017)

## Corporate Headquarters

TOYOSU FORESIA, 3-2-24 Toyosu,  
Koto-ku, Tokyo 135-0061, Japan  
[www.renesas.com](http://www.renesas.com)

## Contact Information

For further information on a product, technology, the most up-to-date version of a document, or your nearest sales office, please visit:  
[www.renesas.com/contact/](http://www.renesas.com/contact/)

## Trademarks

Renesas and the Renesas logo are trademarks of Renesas Electronics Corporation. All trademarks and registered trademarks are the property of their respective owners.