

Product Overview

The QPB7400 is a low-cost RF amplifier designed for applications from 47 to 1218 MHz. The balance of low noise and distortion provides an ideal solution for a wide range of broadband amplifiers used in cable television applications such as optical receivers and low noise front ends.

The QPB7400 has features allowing a great deal of design-in flexibility. Gain and return loss are adjustable with an external feedback resistor. An internal bias circuit mitigates the effect of temperature and process variation and an external resistor may be used to adjust the bias current to optimize distortion or noise performance.

The QPB7400 is fabricated using 6-inch GaAs pHEMT technology to optimize performance and cost. It provides excellent gain and return loss consistency inherent to the pHEMT process.

Functional Block Diagram

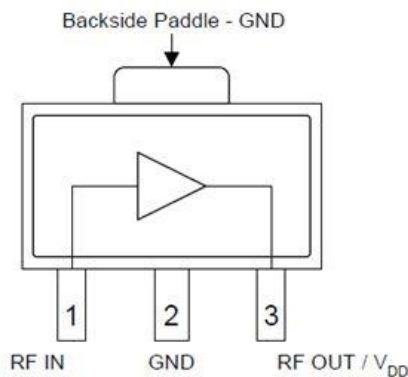

Top View



3-pin SOT-89 Package

Key Features

- Gain, return loss, and bias externally adjustable
- 47–1218 MHz bandwidth (DOCSIS 3.1 Compatible)
- CCN – 65 dBc, CSO – 70 dBc, and CTB – 77 dBc for 33 dBmV/ch at output (-6 dB for QAM), 80 NTSC + 108 QAM, flat loading
- +5 V Biasing, 105 mA Current Consumption
- On-chip active bias for consistent bias current and repeatable performance over temperature
- Low Noise: 3.5 dB to 1218 MHz
- +41 dBm typical OIP3
- +60 dBm typical OIP2
- pHEMT device technology

Applications

- Single-ended and Push-Pull Optical Receivers
- Low-noise Drop Amplifiers
- Distribution Amplifiers
- Multi-Dwelling Units
- Single-ended Gain Block

Ordering Information

Part No.	Description
QPB7400SQ	Sample bag with 25 pieces
QPB7400SR	7" reel with 100 pieces
QPB7400TR13	13" reel with 2500 pieces
QPB7400PCK	PCBA with 5 piece sample bag

Absolute Maximum Ratings

Parameter	Rating
Supply Voltage (V _{DD})	+7 V
Supply Current (I _{DD})	130mA
Maximum Input Level	60dBmV
Operating Temperature Range	-40 to +100°C
T _j for >10 ⁶ hours MTTF	+165 °C
Storage Temperature	-65 to +150 °C

Operation of this device outside the parameter ranges given above may cause permanent damage.

Recommended Operating Conditions

Parameter	Min	Typ	Max	Units
Supply Voltage (V _{DD})	+4.5		+5.5	V
Supply Current (I _{DD})		105		mA

Electrical specifications are measured at specified test conditions. Specifications are not guaranteed over all recommended operating conditions.

Electrical Specifications

Parameter	Condition ⁽¹⁾	Min	Typ	Max	Unit
Frequency Range		47		1218	MHz
Gain			+10.5		dB
Gain Slope			-0.5		dB
Noise Figure			+3.5		dB
Input Return Loss			+18		dB
Output Return Loss			+18		dB
Output P1dB			+17		dBm
Output IP2	f1 = 225 MHz, f2 = 325 MHz, Pout = +5 dBm / tone		+60		dBm
Output IP3	f1 = 225 MHz, f2 = 325 MHz, Pout = +5 dBm / tone		+41		dBm
CSO	33 dBmV / ch at output, flat loading (-6 dB for QAM), 80 ch NTSC + 108 QAM to 1218 MHz		-70		dBc
CTB			-80		
CCN			-65		
Thermal Resistance	Junction to case		+42		°C / W

Notes:

1. Typical performance at these conditions: Temp. = +25 °C, V_{DD} = +5 V, 75 Ω system

Evaluation Board Schematic

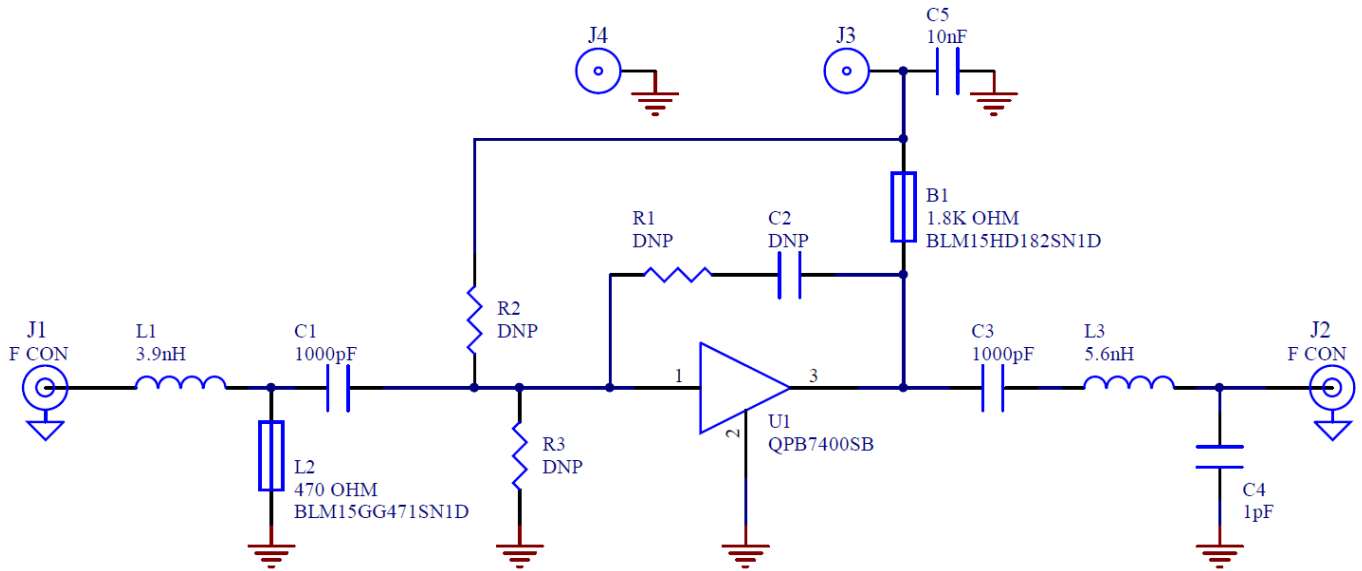

Bill of Materials (BOM)

Description	Designator	Manufacturer	Part Number
QPB7400 Low Gain GP CATV Amplifier	U1	Qorvo	QPB7400SB
PCB, QPB7400		Viasystems Technologies Corp., L.L.	QPB7400-4000(C)
CAP, 1000 pF, 10 %, 50 V, 0402	C1, C3	Murata Electronics	GRM155R71H102KA01D
CAP, 1 pF ±0.10 pF, 50 V, 0402	C4	AVX/Kyocera Asia, Ltd	04025A1R0BAT2A
CAP, 10000 pF, 10 %, 50 V, X7R, 0402	C5	Murata Electronics	GRM155R71H103KA88D
IND, 3.9 nH, 5%, Ceramic, Lead-free, 0402	L1	Murata Electronics	LL1005-FHL3N9S
IND, 5.6 nH, +/- .5, LF Ceramic, 0402	L3	Murata Electronics	LL1005-FHL5N6S
Ferrite Bead, 1.8 K Ω, 200 mA, 0402	B1	Murata Electronics	BLM15HD182SN1D
Ferrite Bead, 470 Ω, 200 mA, 0402	L2	Murata Electronics	BLM15GG471SN1D
Solder Turret	J3, J4	Mill-Max Manufacturing	2533-0-00-44-00-00-07-0
Connector 75 Ω, Edge Launch F	J1, J2	Lighthouse Technologies	LTI-FSF55NT-P
Not Populated	C2, R1, R2, R3		

Evaluation Board Assembly Drawing

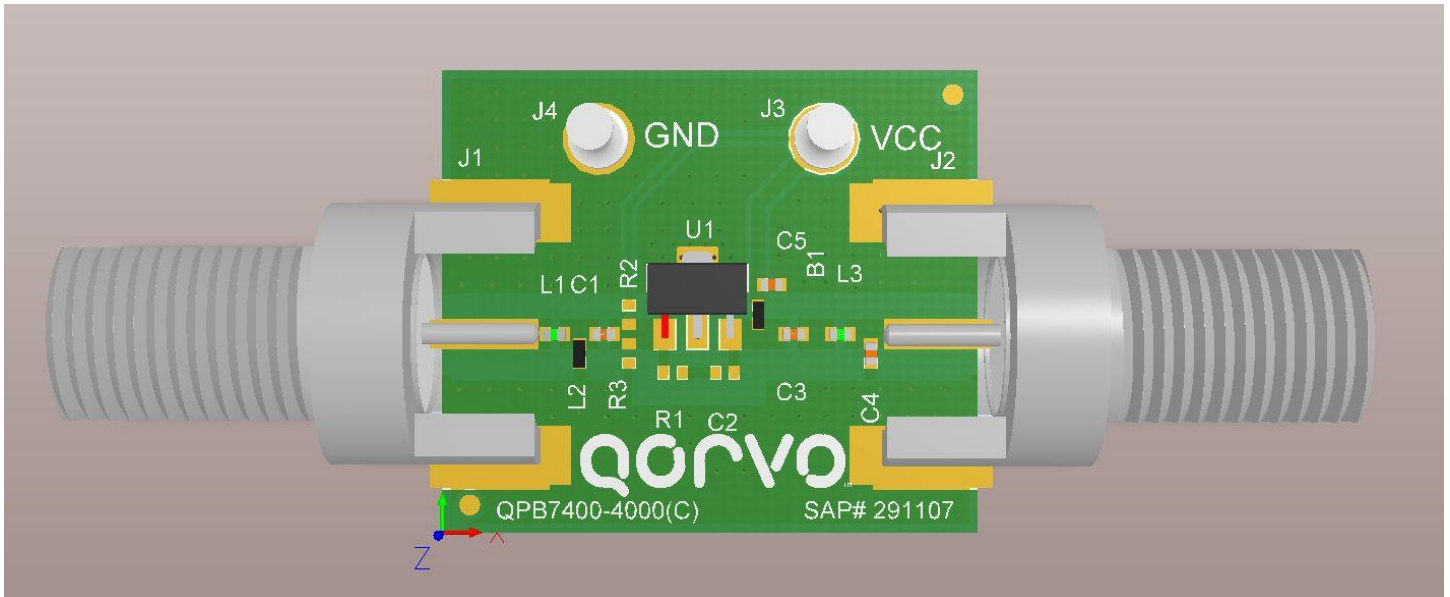

Typical Application Schematic, 47MHz – 1218MHz

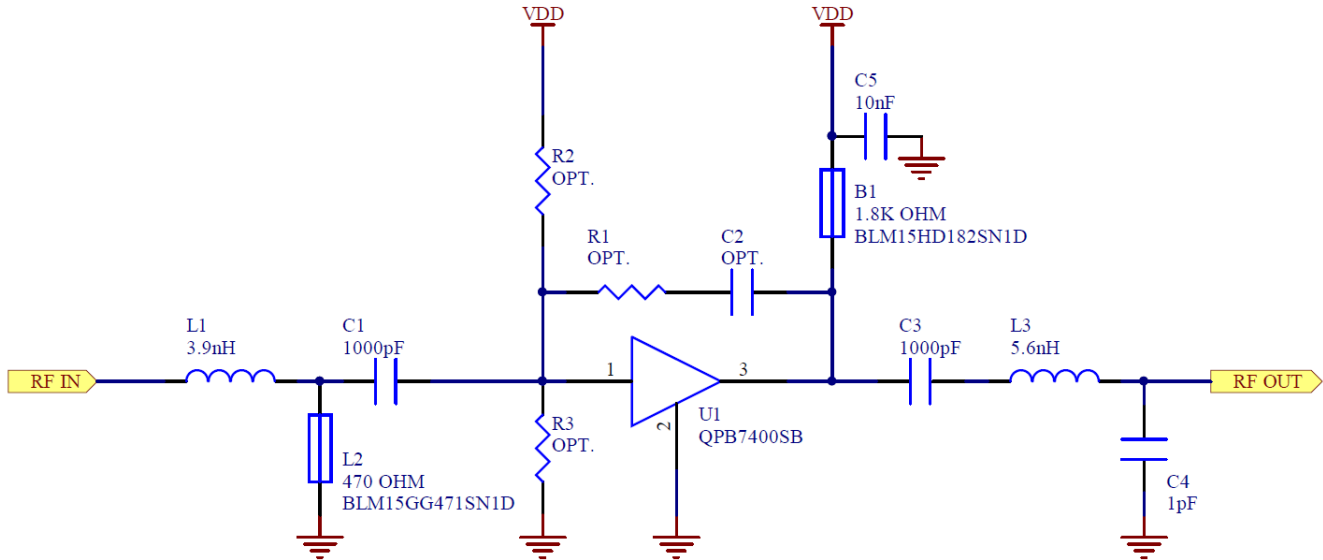

Notes:

1. L1/L2 tunes input return loss (L2 improves low frequency return loss).
2. C1 and C3 are for DC blocking.
3. L3/C4 tunes output return loss.
4. B1 is a broadband impedance choke for DC bias.
5. R1 provides optional feedback to reduce gain to as low as 7.5dB (typ. gain of 10.5dB with no feedback). When feedback is employed, C2 is required for DC blocking. Refer to Additional Application Data section for values of feedback versus gain.
6. R2, R3 are pullup and pulldown options that can be added to adjust the bias current to tradeoff distortion performance or reduce power consumption. Refer to Additional Application Data section for resistance values versus current and performance tradeoffs.

Additional Application Data; Feedback Resistor Options

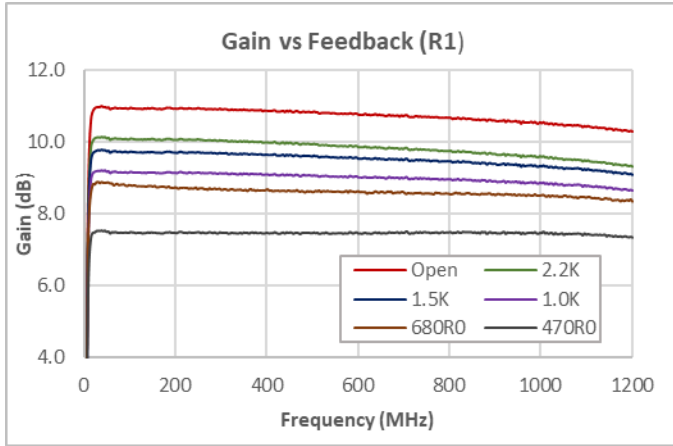

Performance at 1GHz for values of R1			
R1 (ohms)	Gain (dB)	S11 (dB)	S22 (dB)
Open	10.5	-19.8	-22.6
2.2K	9.6	-17.3	-17.6
1.5K	9.3	-16.9	-17.1
1.0K	8.9	-15.7	-16.1
680	8.5	-15.9	-15.4
470	7.5	-12.5	-13.2

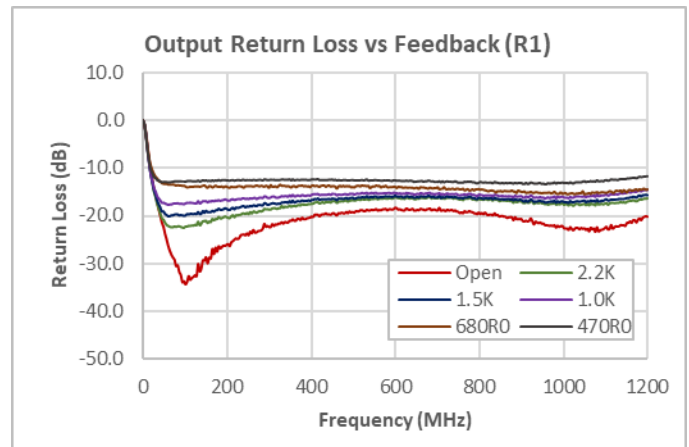
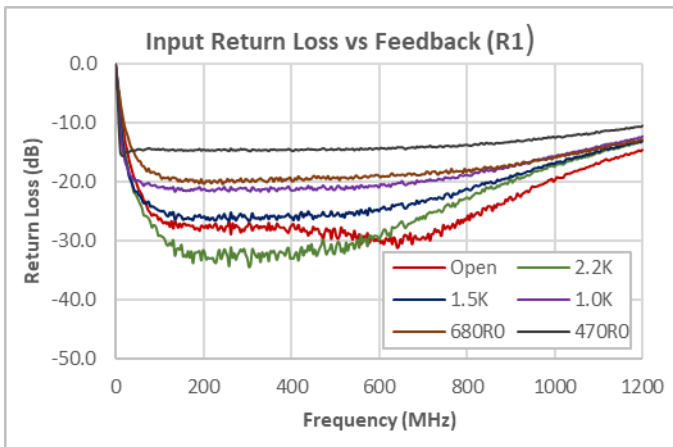

Notes:

- (1) R1 value as noted, C2 = 10nF, V_{DD} = 5V

Additional Application Data; Pullup Resistor Options

Bias Current vs R2/R3

R2 Pullup (ohms)	R3 Pulldown (ohms)	IDD (mA)
Open	3.3K	91
Open	4.7K	94
Open	10K	99
Open	Open	105
10K	Open	109
4.7K	Open	115
3.3K	Open	119

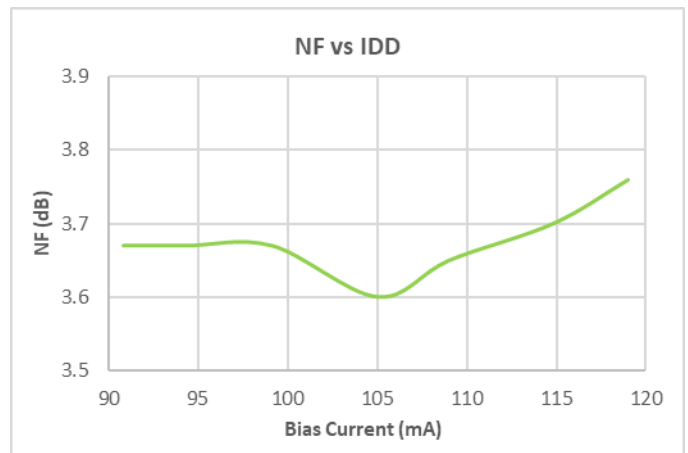
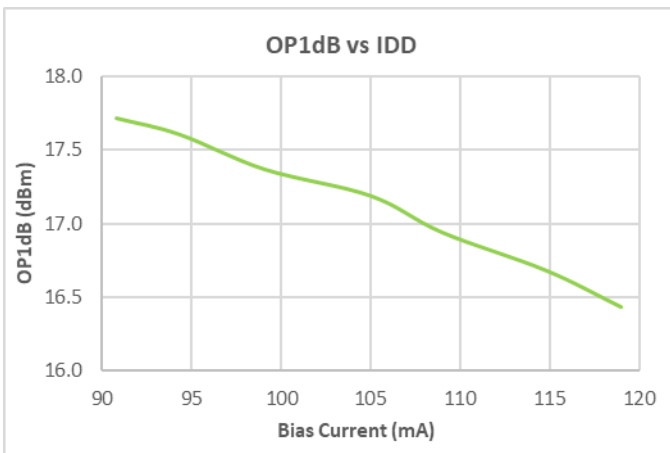
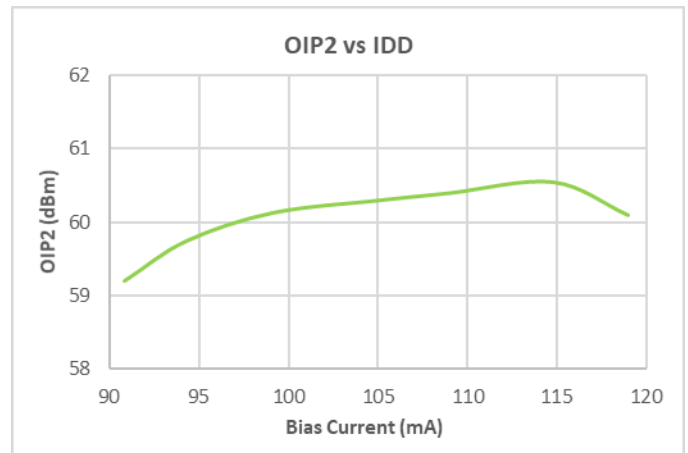
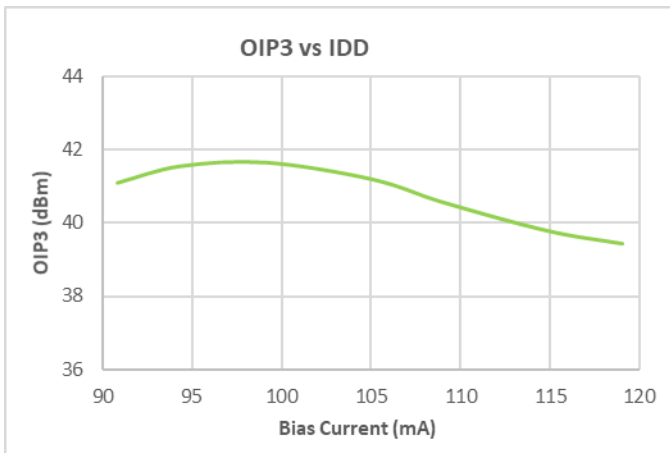

Notes:
(1) $V_{DD} = 5V$

Performance Data – 5V

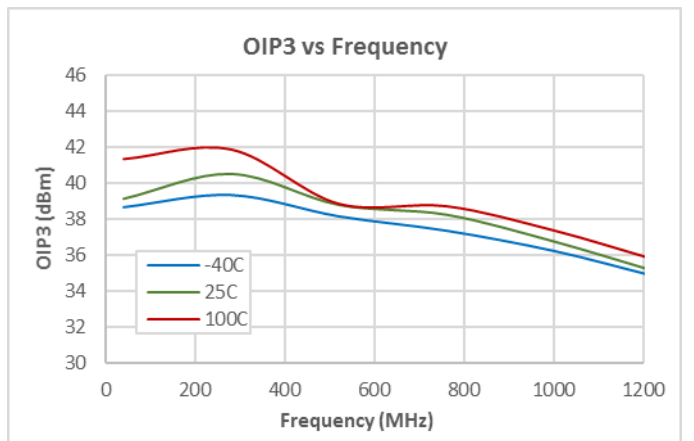
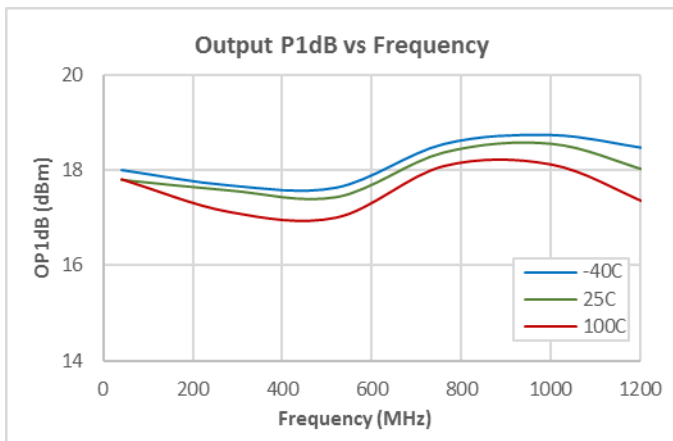
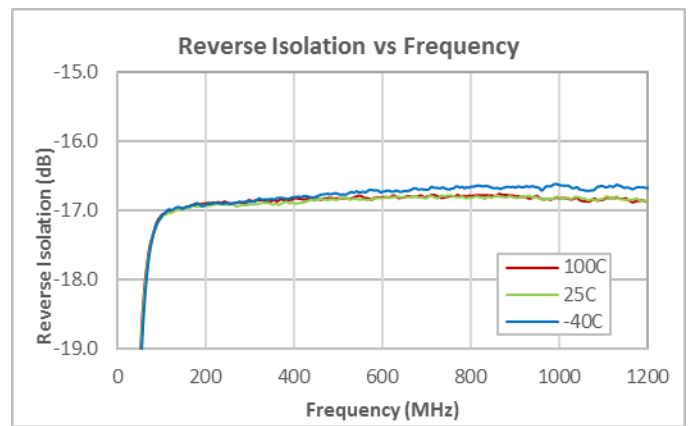
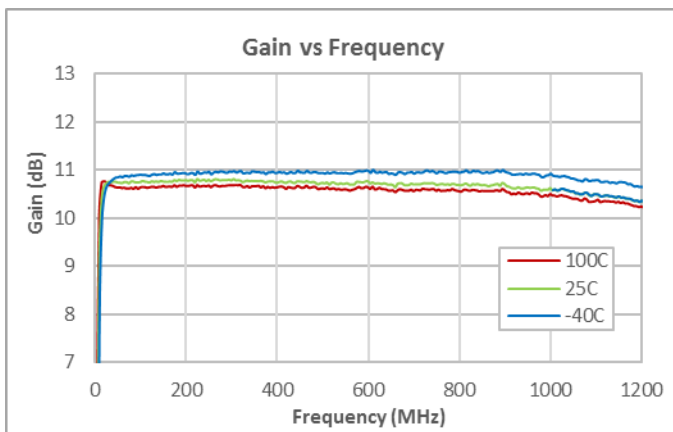
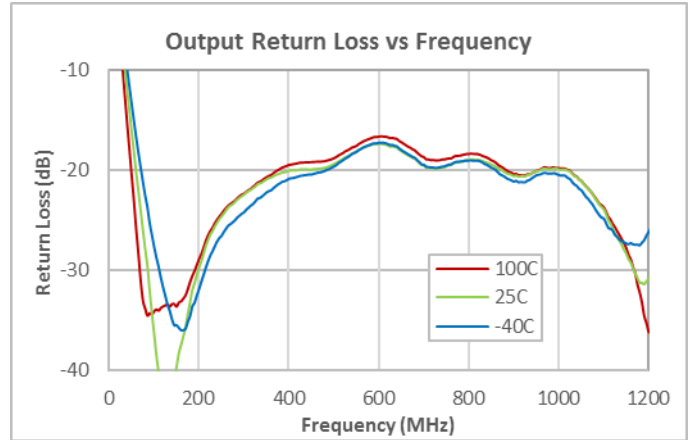
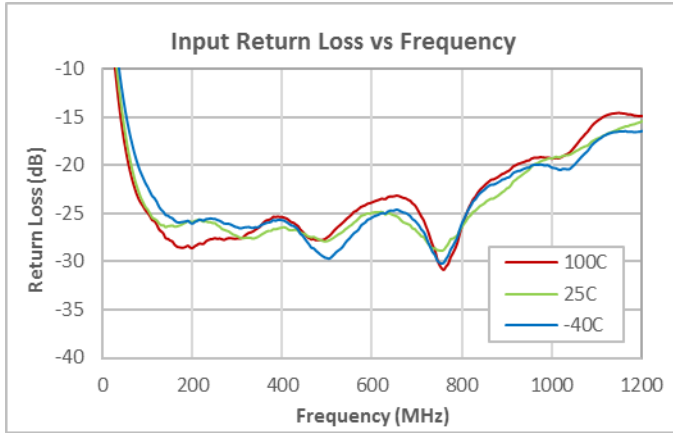

Notes:
(2) OIP3: Pout = +5dBm/tone

Performance Data – 5V

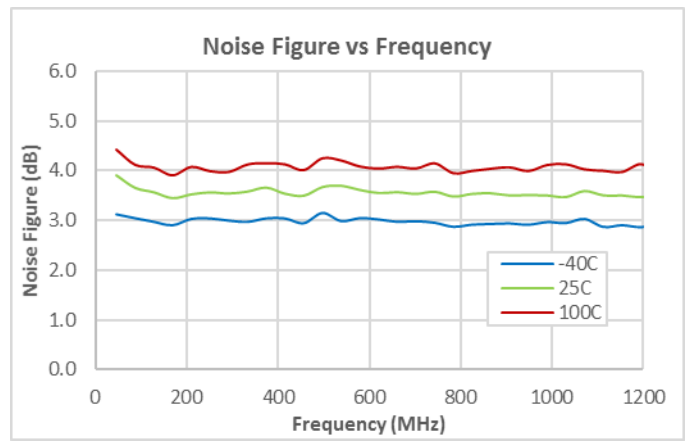
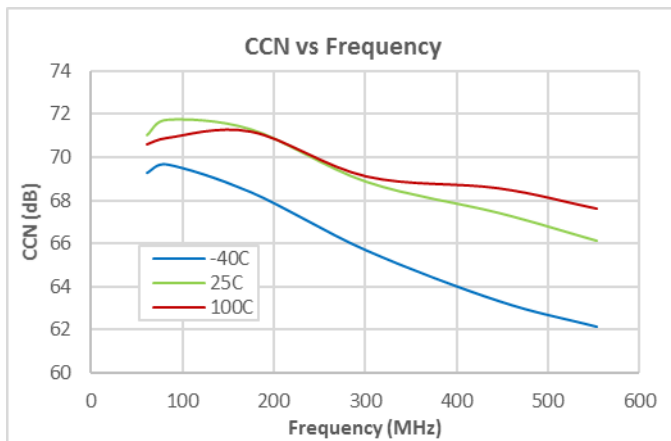
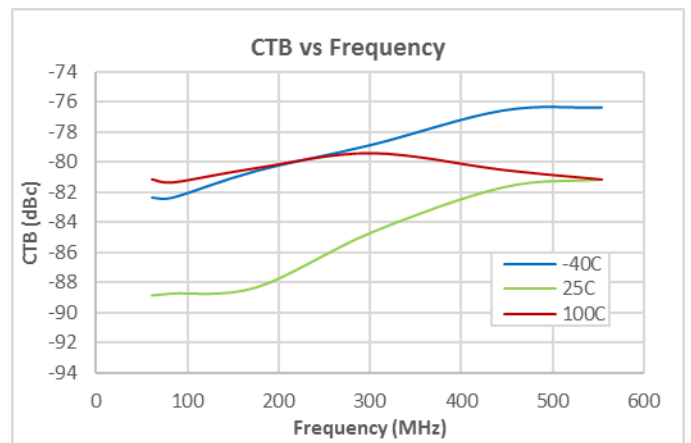
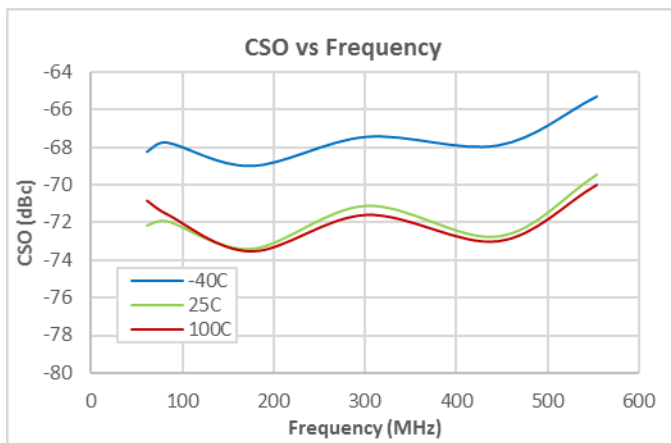
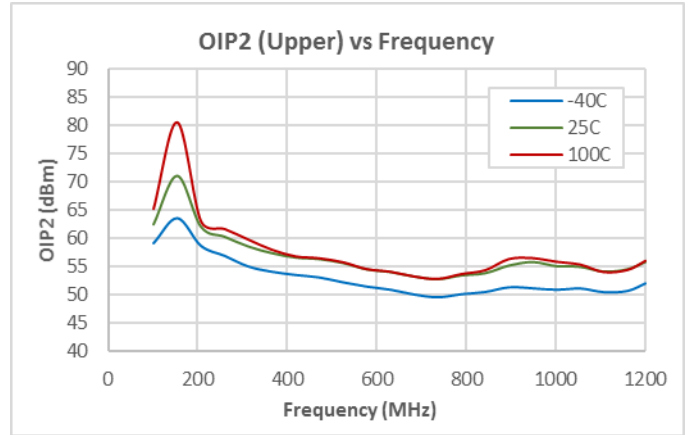
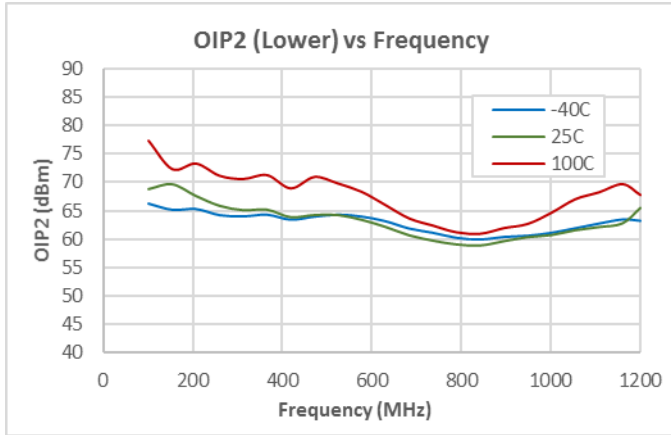

Notes:

- (1) OIP2: Pout = +5 dBm/ tone
- (2) CSO/CTB, CCN: 33 dBmV/ ch at output, flat loading (-6 dB for QAM), 80 ch NTSC + 108 QAM to 1218 MHz

Performance Data – 5V

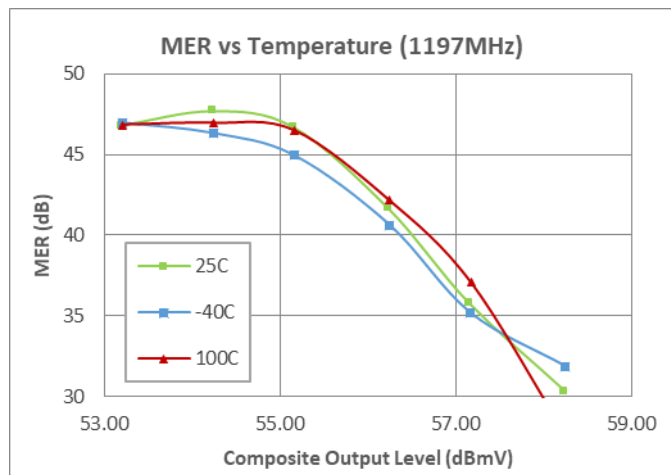
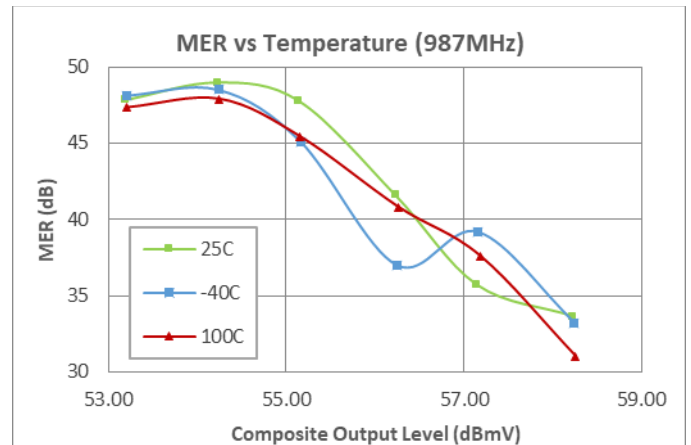
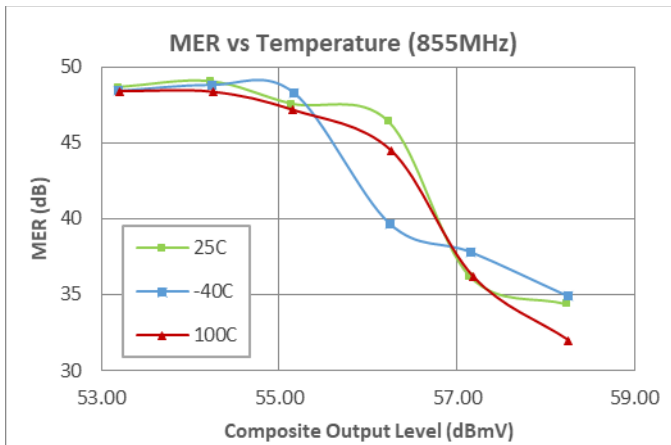
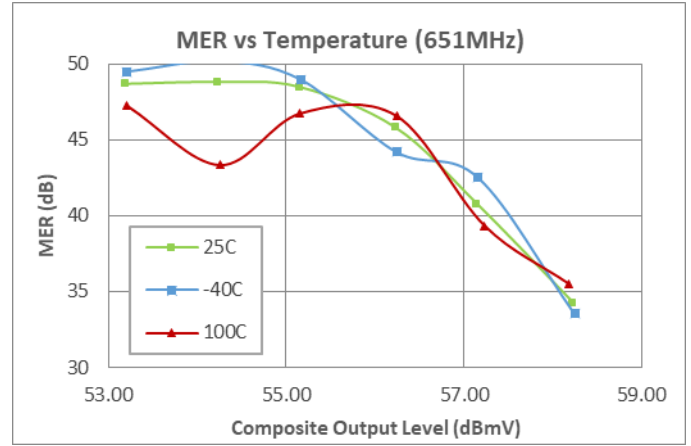
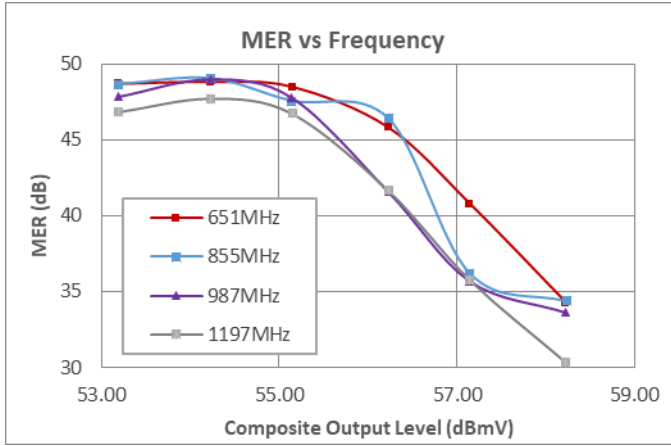

Notes:

- (1) MER: 79 ch NTSC + 111 QAM to 1218 MHz, 0db tilt (QAM -6dB), ITU-T J.83, Annex B

Pin Configuration and Description

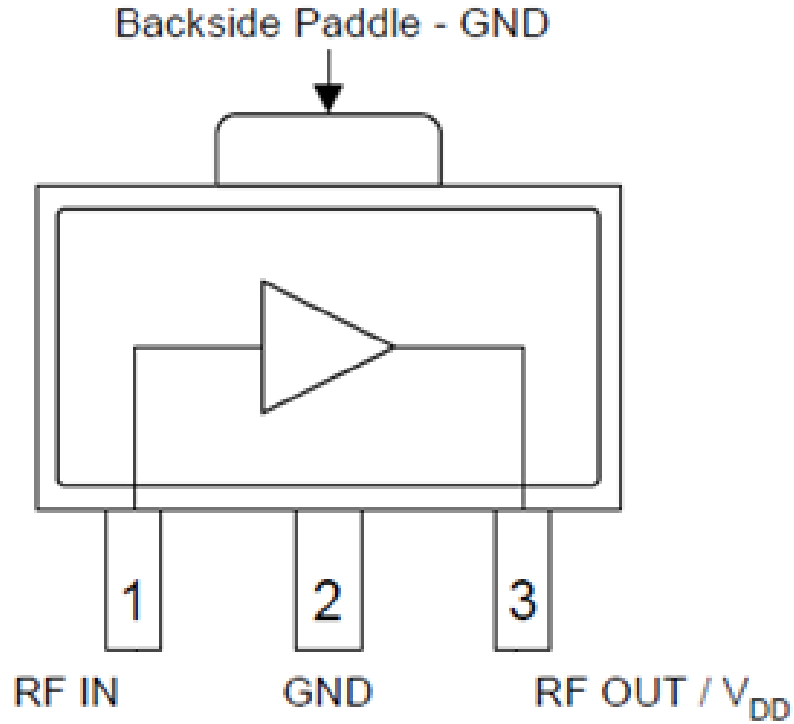

Pin Number	Label	Description
1	RF IN	RF Input – DC blocking capacitor required
2	GND	GND – DC, RF, and Thermal
3	RF OUT/VDD	RF Output – VDD bias choke required

Package Marking

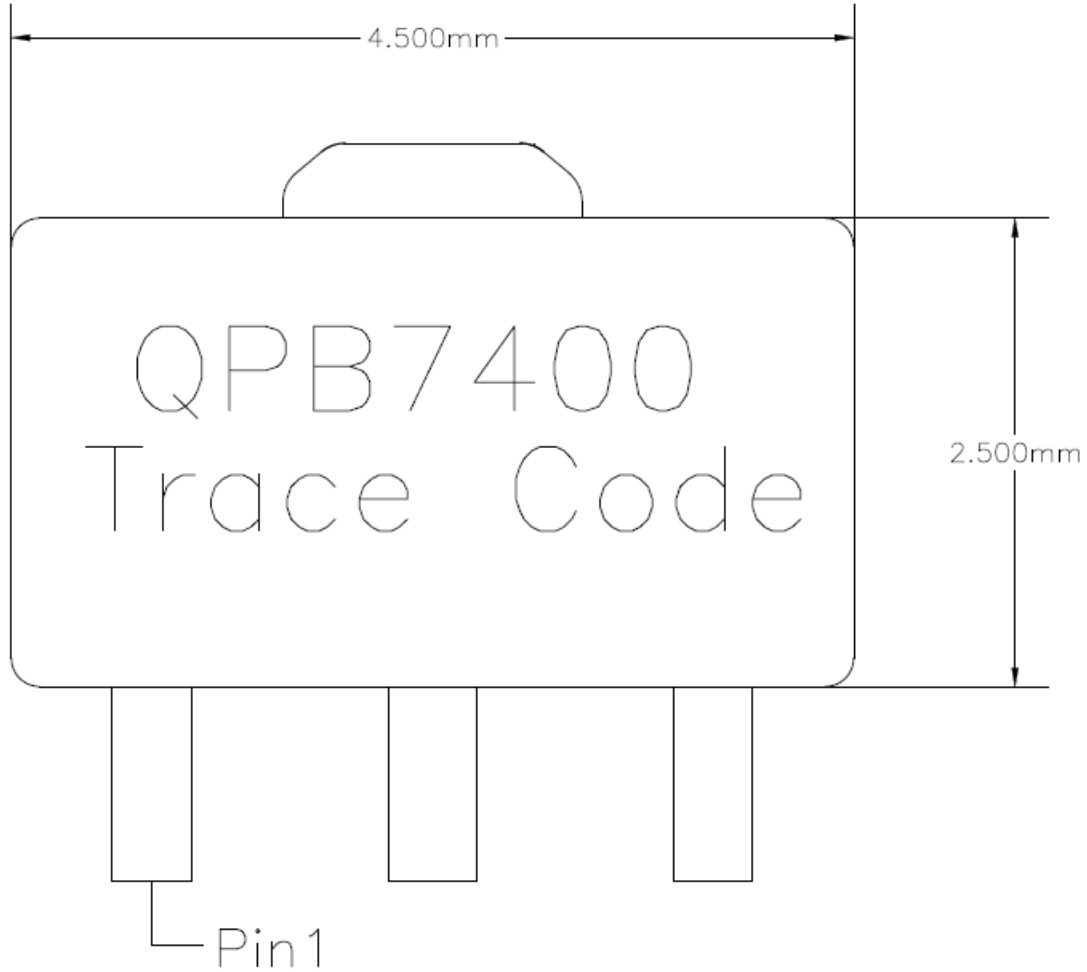

Line 1 – Part Number
Line 2 – Short Trace Code (Up to 4 Characters)
Trace Code to be assigned by Sub Con

PCB Mounting Pattern

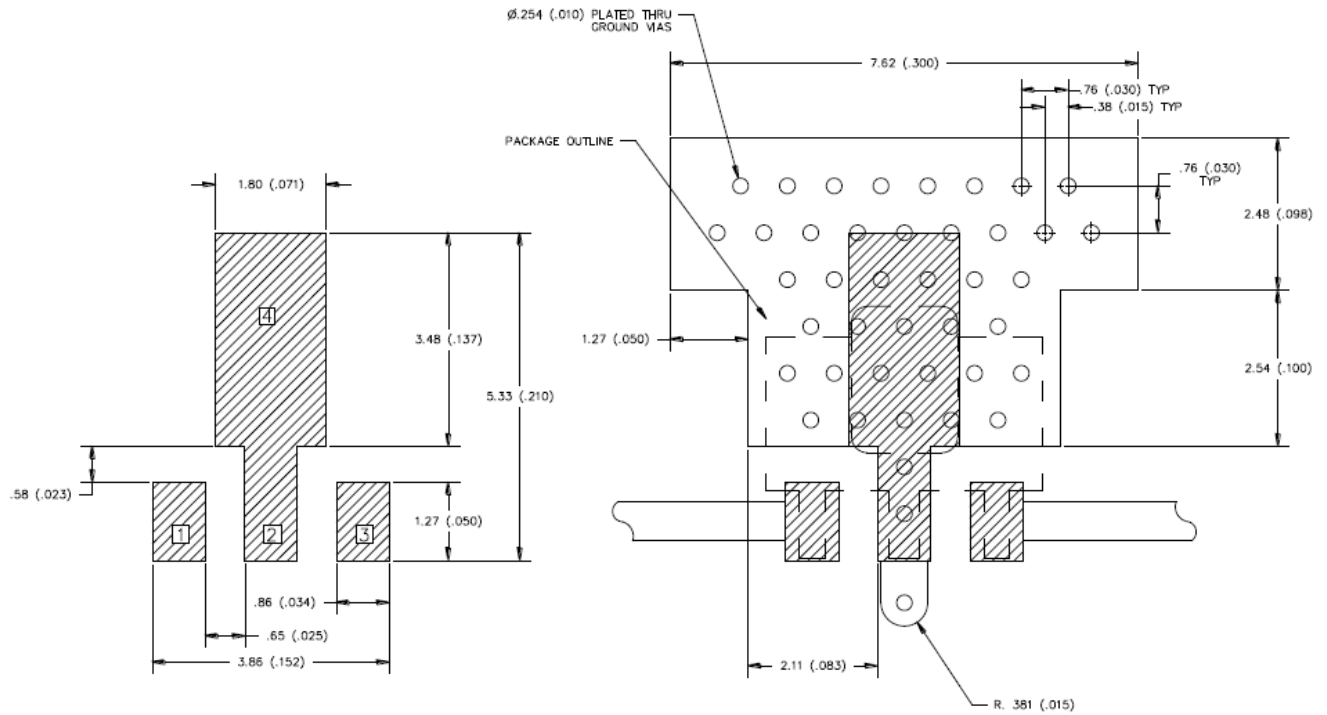

Notes:

1. Ground/thermal vias are critical for the proper performance of this device. Vias should use a .35 mm (#80/.0135") diameter drill and have a final, plated thru diameter of 0.25 mm (0.010").
2. Add as much copper as possible to inner and outer layers near the part to ensure optimal thermal performance.
3. RF trace width depends upon the PC board material and construction.
4. All dimensions are in millimeters (inches). Angles are in degrees.

Handling Precautions

Parameter	Rating	Standard
ESD – Human Body Model (HBM)	Class 1B (500-1000V)	ESDA / JEDEC JS-001-2014
ESD – Charged Device Model (CDM)	Class C3 (>1000V)	JEDEC JESD22-C101F
MSL1 – Moisture Sensitivity Level	Level 1	IPC/JEDEC J-STD-020



Caution!
ESD-Sensitive Device

Solderability

Compatible with both lead-free (260 °C max. reflow temp.) and tin/lead (245 °C max. reflow temp.) soldering processes. Solder profiles available upon request.

Contact plating: Matte Sn

RoHS Compliance

This part is compliant with 2011/65/EU RoHS directive (Restrictions on the Use of Certain Hazardous Substances in Electrical and Electronic Equipment) as amended by Directive.

This product also has the following attributes:

- Lead Free
- Halogen Free (Chlorine, Bromine)
- Antimony Free
- TBBP-A (C₁₅H₁₂Br₄O₂) Free
- PFOS Free
- SVHC Free



Contact Information

For the latest specifications, additional product information, worldwide sales and distribution locations:

Tel: 1-844-890-8163

Web: www.qorvo.com

Email: customer.support@qorvo.com

Important Notice

The information contained herein is believed to be reliable; however, Qorvo makes no warranties regarding the information contained herein and assumes no responsibility or liability whatsoever for the use of the information contained herein. All information contained herein is subject to change without notice. Customers should obtain and verify the latest relevant information before placing orders for Qorvo products. The information contained herein or any use of such information does not grant, explicitly or implicitly, to any party any patent rights, licenses, or any other intellectual property rights, whether with regard to such information itself or anything described by such information. **THIS INFORMATION DOES NOT CONSTITUTE A WARRANTY WITH RESPECT TO THE PRODUCTS DESCRIBED HEREIN, AND QORVO HEREBY DISCLAIMS ANY AND ALL WARRANTIES WITH RESPECT TO SUCH PRODUCTS WHETHER EXPRESS OR IMPLIED BY LAW, COURSE OF DEALING, COURSE OF PERFORMANCE, USAGE OF TRADE OR OTHERWISE, INCLUDING THE IMPLIED WARRANTIES OF MERCHANTABILITY AND FITNESS FOR A PARTICULAR PURPOSE.**

Without limiting the generality of the foregoing, Qorvo products are not warranted or authorized for use as critical components in medical, life-saving, or life-sustaining applications, or other applications where a failure would reasonably be expected to cause severe personal injury or death.

Copyright 2019 © Qorvo, Inc. | Qorvo is a registered trademark of Qorvo, Inc.