

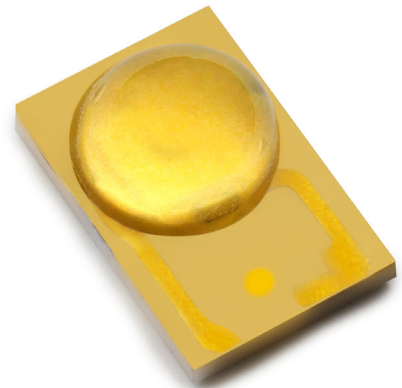

LUXEON Rebel PLUS

The original high power LED

LUXEON Rebel PLUS is designed with the highest possible efficacy and light output from an industry standard 4530 package with a 2.5mm² dome. With hot testing and color binning, every LUXEON Rebel PLUS is tested and specified at real world operating conditions—85°C. Our exceptional color control enables design simplicity for luminaire manufacturers and ensures that they can be confident in color consistency from LED to LED. The superior quality of light, light output, and real world efficacy enable leading performance and efficient solution development in a wide variety of outdoor and industry lighting segments.



FEATURES AND BENEFITS

3- and 5-step MacAdam ellipse: *Freedom from Binning* for superior quality of light

Ability to deliver high lm/\$ for Indoor applications

Low typical V_f ~2.8V

Small optical source size

Full range of CCTs in 80CRI minimum

LM-80 test report available

PRIMARY APPLICATIONS

High Bay & Low Bay

Outdoor

Table of Contents

General Product Information	2
Product Test Conditions	2
Part Number Nomenclature	2
Lumen Maintenance	2
Environmental Compliance	2
Performance Characteristics	3
Product Selection Guide	3
Optical Characteristics	3
Electrical and Thermal Characteristics	4
Absolute Maximum Ratings	4
Characteristic Curves	5
Spectral Power Distribution Characteristics	5
Light Output Characteristics	5
Forward Current Characteristics	6
Radiation Pattern Characteristics	7
Product Bin and Labeling Definitions	7
Decoding Product Bin Labeling	7
Luminous Flux Bins	8
Color Bin Definitions	8
Forward Voltage Bins	9
Mechanical Dimensions	9
Reflow Soldering Guidelines	10
JEDEC Moisture Sensitivity	10
Pad Configuration	11
Solder Pad Design	11
Packaging Information	12
Pocket Tape Dimensions	12
Reel Dimensions	13

General Product Information

Product Test Conditions

LUXEON Rebel PLUS LEDs are tested and binned with a DC drive current of 350mA at a junction temperature, T_j , of 85°C.

Part Number Nomenclature

Part numbers for LUXEON Rebel PLUS follow the convention below:

L X 1 8 – P 1 **A A** – **B**

Where:

A A – designates nominal ANSI CCT (27=2700K, 30=3000K, 35=3500K, 40=4000K, 50=5000K)

B – designates color definition (3=3 SDCM and 5=5 SDCM)

Therefore, the following part number is used for a LUXEON Rebel PLUS 3000K with 3 SDCM:

L X 1 8 – P 1 **3 0** – **3**

Lumen Maintenance

Please contact your local Sales Representative or Lumileds Technical Solutions Manager for more information about the long-term performance of this product.

Environmental Compliance

Lumileds LLC is committed to providing environmentally friendly products to the solid-state lighting market. LUXEON Rebel PLUS is compliant to the European Union directives on the restriction of hazardous substances in electronic equipment, namely the RoHS Directive 2011/65/EU and REACH Regulation (EC) 1907/2006. Lumileds LLC will not intentionally add the following restricted materials to its products: lead, mercury, cadmium, hexavalent chromium, polybrominated biphenyls (PBB) or polybrominated diphenyl ethers (PBDE).

Performance Characteristics

Product Selection Guide

Table 1. Product performance of LUXEON Rebel PLUS at 350mA and 700mA, $T_j=85^\circ\text{C}$.

NOMINAL CCT	MINIMUM CRI ^[1, 2]	LUMINOUS FLUX ^[1] (lm)		TYPICAL LUMINOUS EFFICACY (lm/W)	TYPICAL LUMINOUS FLUX (lm)	TYPICAL LUMINOUS EFFICACY (lm/W)	PART NUMBER
		MINIMUM	TYPICAL				
		350mA					
2700K	80	80	85	88	156	78	LX18-P127-x
3000K	80	85	95	98	166	83	LX18-P130-x
3500K	80	90	98	101	172	86	LX18-P135-x
4000K	80	90	103	107	180	90	LX18-P140-x
5000K	80	95	106	110	186	93	LX18-P150-x

Notes for Table 1:

1. Lumileds maintains a tolerance of ± 2 on CRI and $\pm 6.5\%$ on luminous flux measurements.
2. Typical CRI is approximately 2 points higher than the minimum CRI specified, but this is not guaranteed.

Optical Characteristics

Table 2. Optical characteristics for LUXEON Rebel PLUS at 350mA, $T_j=85^\circ\text{C}$.

PART NUMBER	TYPICAL TOTAL INCLUDED ANGLE ^[1]	TYPICAL VIEWING ANGLE ^[2]
LX18-P127-x	160°	120°
LX18-P130-x	160°	120°
LX18-P135-x	160°	120°
LX18-P140-x	160°	120°
LX18-P150-x	160°	120°

Notes for Table 2:

1. Total angle at which 90% of total luminous flux is captured.
2. Viewing angle is the off axis angle from the LED centerline where the luminous intensity is $\frac{1}{2}$ of the peak value.

Electrical and Thermal Characteristics

Table 3. Electrical and thermal characteristics for LUXEON Rebel PLUS at 350mA, T_j=85°C.

PART NUMBER	FORWARD VOLTAGE ^[1] (V _f)			TYPICAL TEMPERATURE COEFFICIENT OF FORWARD VOLTAGE ^[2] (mV/°C)	TYPICAL THERMAL RESISTANCE—JUNCTION TO SOLDER PAD (°C/W)
	MINIMUM	TYPICAL	MAXIMUM		
LX18-P127-x	2.5	2.8	3.0	-1.0 to -3.0	9.0°
LX18-P130-x	2.5	2.8	3.0	-1.0 to -3.0	9.0°
LX18-P135-x	2.5	2.8	3.0	-1.0 to -3.0	9.0°
LX18-P140-x	2.5	2.8	3.0	-1.0 to -3.0	9.0°
LX18-P150-x	2.5	2.8	3.0	-1.0 to -3.0	9.0°

Notes for Table 3:

1. Lumileds maintains a tolerance of ±0.06V on forward voltage measurements.
2. Measured between 25°C and 110°C.

Absolute Maximum Ratings

Table 4. Absolute maximum ratings for LUXEON Rebel PLUS.

PARAMETER	MAXIMUM PERFORMANCE
DC Forward Current ^[1, 2]	1000mA
Peak Pulsed Forward Current ^[1, 3]	1000mA
LED Junction Temperature ^[1] (DC & Pulse)	150°C
ESD Sensitivity (ANSI/ESDA/JEDEC JS-001-2012)	< 8000V Human Body Model (HBM) Class 3A JESD22-A114-E
Operating Case Temperature ^[1]	-40°C to 135°C
LED Storage Temperature	-40°C to 135°C
Soldering Temperature	JEDEC 020c 260°C
Allowable Reflow Cycles	3
Reverse Voltage (V _{reverse})	LUXEON LEDs are not designed to be driven in reverse bias

Notes for Table 4:

1. Proper current derating must be observed to maintain the junction temperature below the maximum allowable junction temperature.
2. Residual periodic variations due to power conversion from alternating current (AC) to direct current (DC), also called "ripple," are acceptable if the following conditions are met:
 - The frequency of the ripple current is 100Hz or higher
 - The average current for each cycle does not exceed the maximum allowable DC forward current
 - The maximum amplitude of the ripple does not exceed the maximum peak pulsed forward current
3. Pulsed operation with the maximum peak pulsed forward current is acceptable if the pulse on-time is ≤5ms per cycle and the duty cycle is ≤50%.

Characteristic Curves

Spectral Power Distribution Characteristics

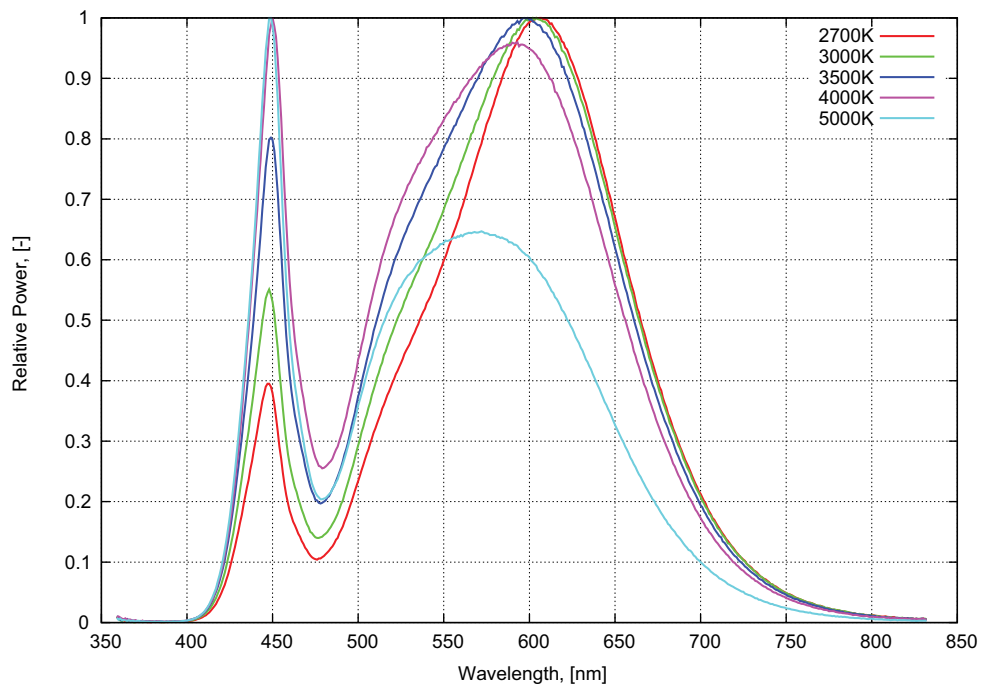

Figure 1. Typical normalized power vs. wavelength for LUXEON Rebel PLUS at test current, $T_j=85^{\circ}\text{C}$.

Light Output Characteristics

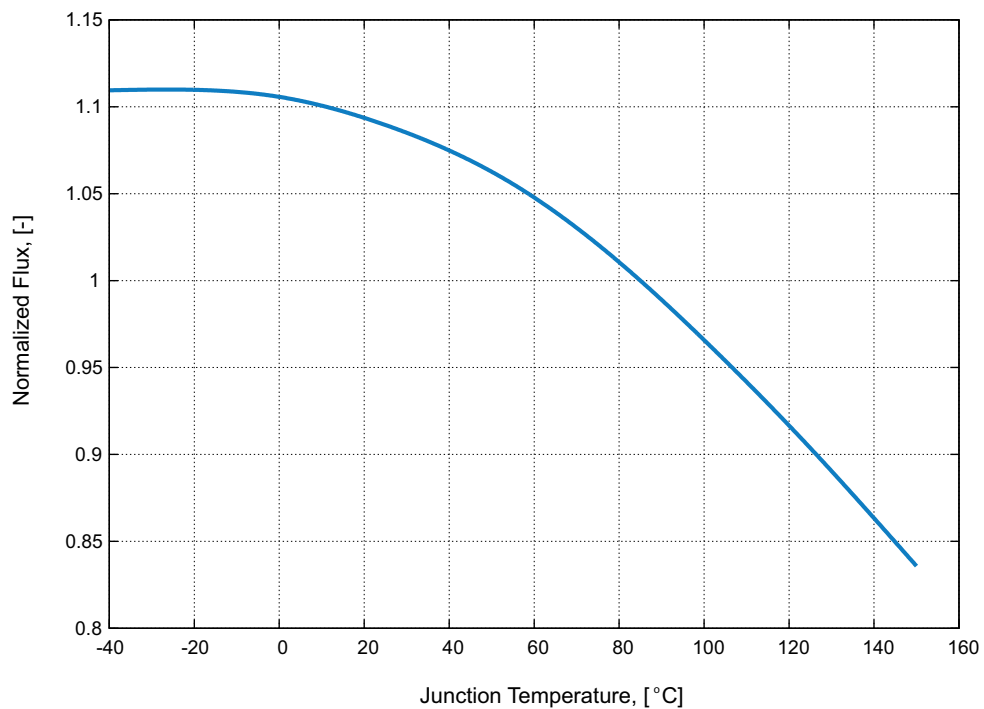

Figure 2. Typical normalized light output vs. junction temperature for LUXEON Rebel PLUS at 350mA.

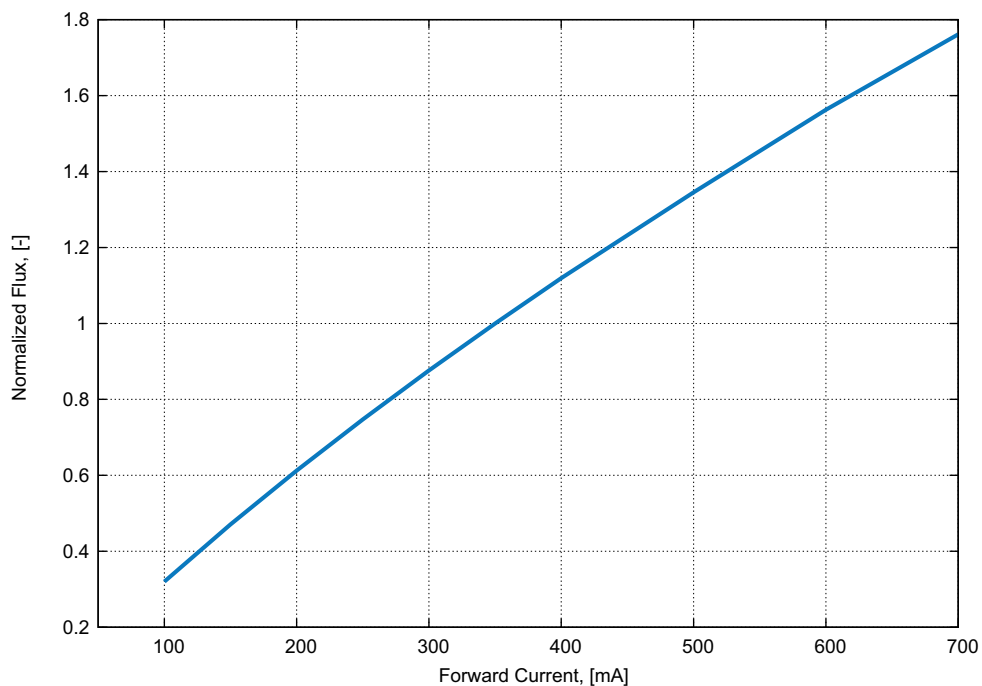

Figure 3. Typical normalized light output vs. forward current for LUXEON Rebel PLUS at $T_j=85^\circ\text{C}$.

Forward Current Characteristics

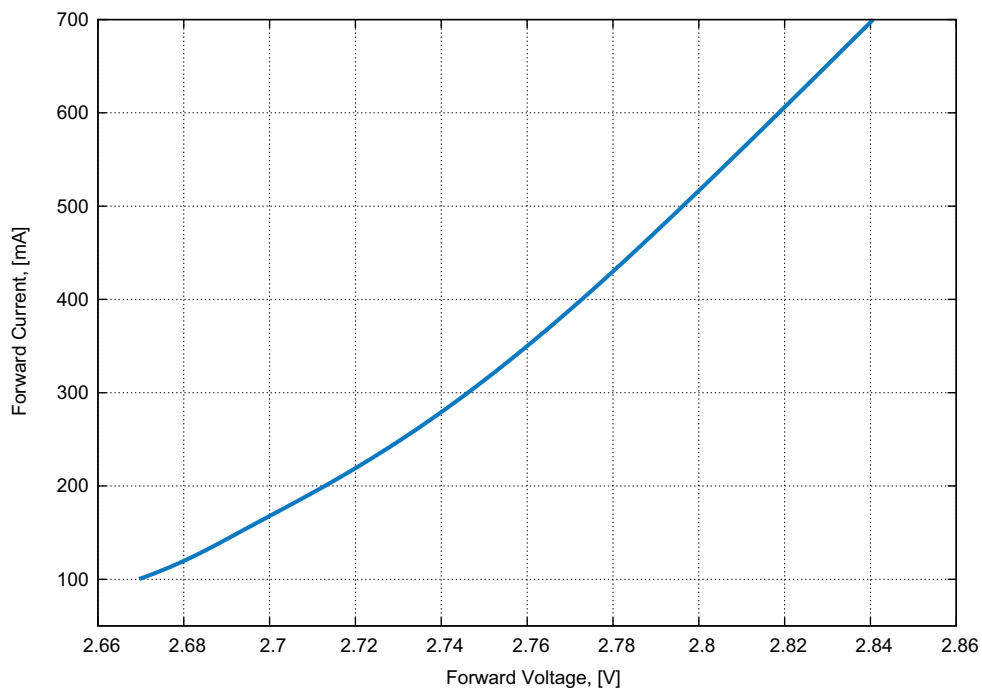

Figure 4. Typical forward current vs. forward voltage for LUXEON Rebel PLUS at $T_j=85^\circ\text{C}$.

Radiation Pattern Characteristics

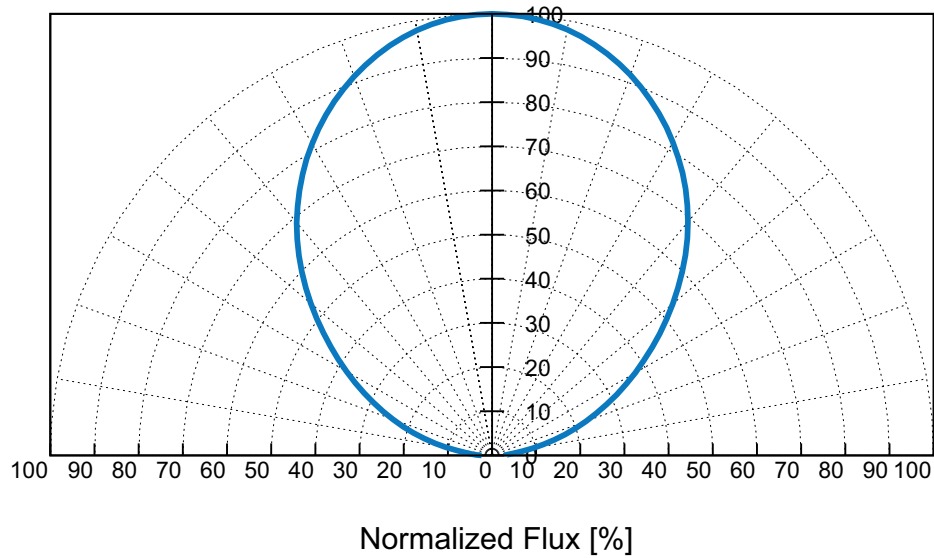

Figure 5. Typical polar radiation pattern for LUXEON Rebel PLUS at 350mA, $T_j=85^{\circ}\text{C}$.

Product Bin and Labeling Definitions

Decoding Product Bin Labeling

In the manufacturing of semiconductor products, there are variations in performance around the average values given in the technical datasheet. For this reason, Lumileds bins LED components for luminous flux or radiometric power, color point, peak or dominant wavelength and forward voltage.

LUXEON Rebel PLUS LEDs are labeled using a 4-digit alphanumeric CAT code following the format below:

A B C D

Where:

- A** – designates luminous flux bin (example: B=85 to 95 lumens, D=105 to 115 lumens)
- B C** – designates color bin (13, 1A, 1B, 1C, 1D)
- D** – designates forward voltage bin (1=2.50 to 2.75V, 2=2.75 to 3.00V)

Therefore, a LUXEON Rebel PLUS with a lumen range of 85 to 95, color bin of 1D and a forward voltage range of 2.50 to 2.75V has the following CAT code:

B 1 D 1

Luminous Flux Bins

Table 5 lists the standard luminous flux bins for LUXEON Rebel PLUS emitters. Although several bins are outlined, product availability in a particular bin varies by production run and by product performance. Not all bins are available in all CCTs.

Table 5. Luminous flux bin definitions for LUXEON Rebel PLUS.

BIN	LUMINOUS FLUX ^[1] (lm)	
	MINIMUM	MAXIMUM
A	75	85
B	85	95
C	95	105
D	105	115
E	115	125
F	125	135

Notes for Table 5:

1. Lumileds maintains a tolerance of ±6.5% on luminous flux measurements.

Color Bin Definitions

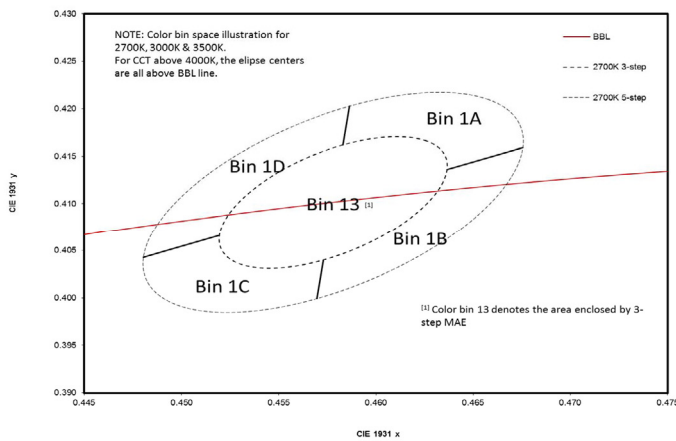

Figure 6. Color space definition for LUXEON Rebel PLUS.

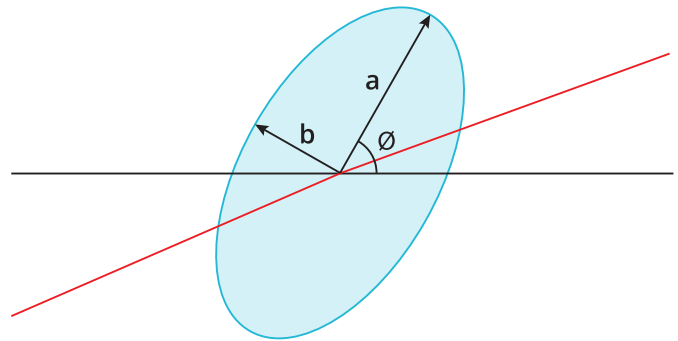

Figure 7. 3- and 5-step MacAdam ellipse illustration for Table 6.

Table 6. 3- and 5-step MacAdam ellipse color bin definitions for LUXEON Rebel PLUS, T_j=85°C.

NOMINAL CCT	COLOR SPACE	CENTER POINT ^[1] (cx, cy)	MAJOR AXIS, a	MINOR AXIS, b	ELLIPSE ROTATION ANGLE, θ
2700K	Single 3-step MacAdam ellipse	(0.4578, 0.4101)	0.00810	0.00420	53.70°
3000K	Single 3-step MacAdam ellipse	(0.4338, 0.4030)	0.00834	0.00408	53.20°
3500K	Single 3-step MacAdam ellipse	(0.4073, 0.3917)	0.00927	0.00414	54.00°
4000K	Single 3-step MacAdam ellipse	(0.3818, 0.3797)	0.00939	0.00402	53.70°
5000K	Single 3-step MacAdam ellipse	(0.3447, 0.3553)	0.00822	0.00354	59.60°
2700K	Single 5-step MacAdam ellipse	(0.4578, 0.4101)	0.01350	0.00700	53.70°
3000K	Single 5-step MacAdam ellipse	(0.4338, 0.4030)	0.01390	0.00680	53.20°
3500K	Single 5-step MacAdam ellipse	(0.4073, 0.3917)	0.01545	0.00690	54.00°
4000K	Single 5-step MacAdam ellipse	(0.3818, 0.3797)	0.01565	0.00670	53.70°
5000K	Single 5-step MacAdam ellipse	(0.3447, 0.3553)	0.01370	0.00590	59.60°

Notes for Table 6:

1. Lumileds maintains a tolerance of ±0.005 on x and y coordinates in the CIE 1931 color space.

Forward Voltage Bins

Table 7. Forward voltage bin definitions for LUXEON Rebel PLUS, $T_j=85^\circ\text{C}$.

BIN	FORWARD VOLTAGE ⁽¹⁾ (V _f)	
	MINIMUM	MAXIMUM
1	2.50	2.75
2	2.75	3.00

Notes for Table 7:

1. Lumileds maintains a tolerance of $\pm 0.06\text{V}$ on forward voltage measurements.

Mechanical Dimensions

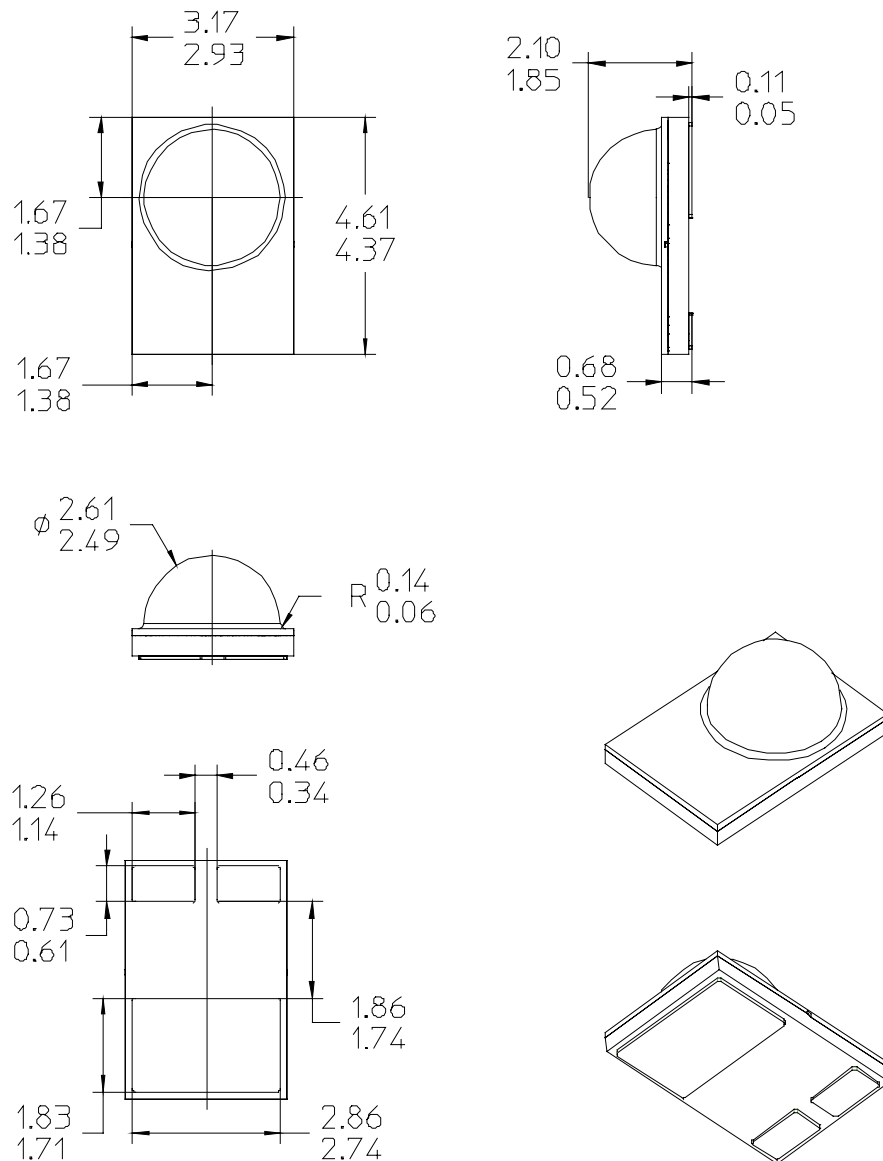

Figure 8. Mechanical dimensions for LUXEON Rebel PLUS.

Notes for Figure 8:

1. Drawings are not to scale.
2. All dimensions are in millimeters.

Reflow Soldering Guidelines

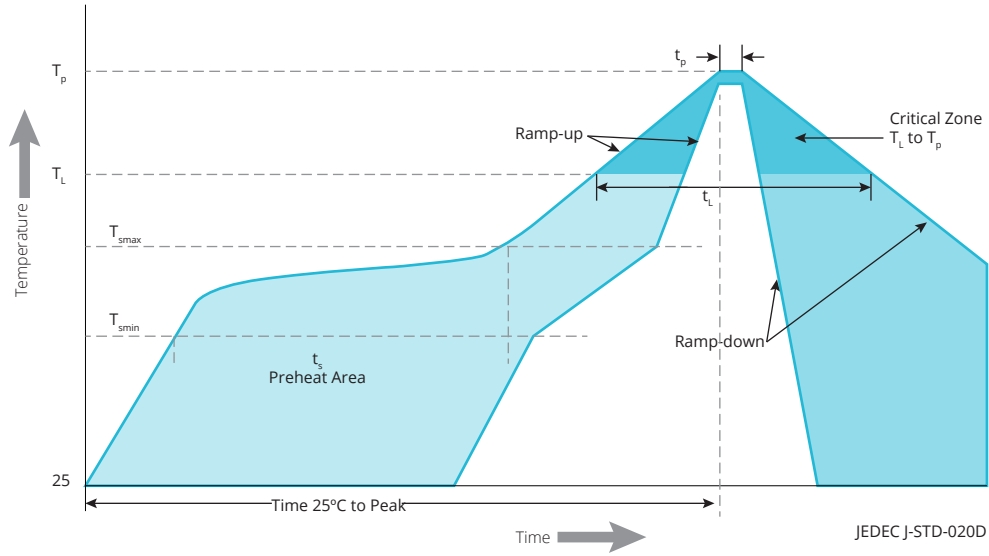

Figure 9. Visualization of the acceptable reflow temperature profile as specified in Table 8.

Table 8. Reflow profile characteristics for LUXEON Rebel PLUS.

PROFILE FEATURE	LEAD-FREE ASSEMBLY
Preheat Minimum Temperature (T_{smin})	150°C
Preheat Maximum Temperature (T_{smax})	200°C
Preheat Time (t_{smin} to t_{smax})	60 to 180 seconds
Ramp-Up Rate (T_L to T_p)	3°C / second maximum
Liquidus Temperature (T_L)	217°C
Time Maintained Above Temperature T_L (t_t)	60 to 150 seconds
Peak / Classification Temperature (T_p)	260°C
Time Within 5°C of Actual Temperature (t_p)	20 to 40 seconds
Ramp-Down Rate (T_p to T_L)	6°C / second maximum
Time 25°C to Peak Temperature	8 minutes maximum

JEDEC Moisture Sensitivity

Table 9. Moisture sensitivity levels for LUXEON Rebel PLUS.

LEVEL	FLOOR LIFE		SOAK REQUIREMENTS STANDARD	
	TIME	CONDITIONS	TIME	CONDITIONS
1	Unlimited	≤30°C / 85% RH	168 Hours +5 / -0	85°C / 85% RH

Pad Configuration

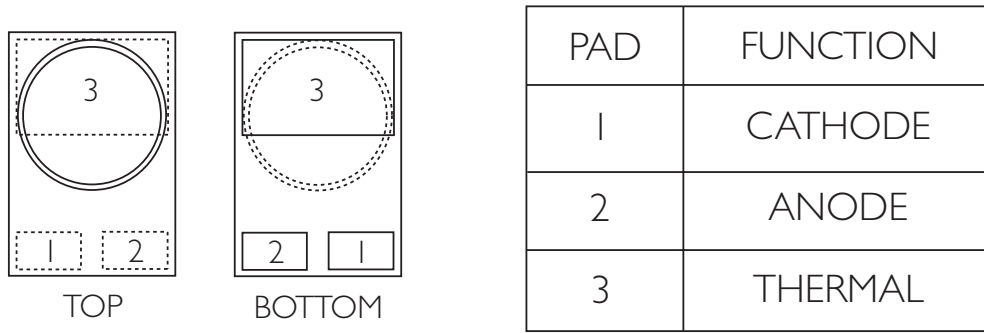

Figure 10. Pad configuration for LUXEON Rebel PLUS.

Notes for Figure 10:

1. The Thermal Pad is electrically isolated from the Anode and Cathode contact pads.

Solder Pad Design

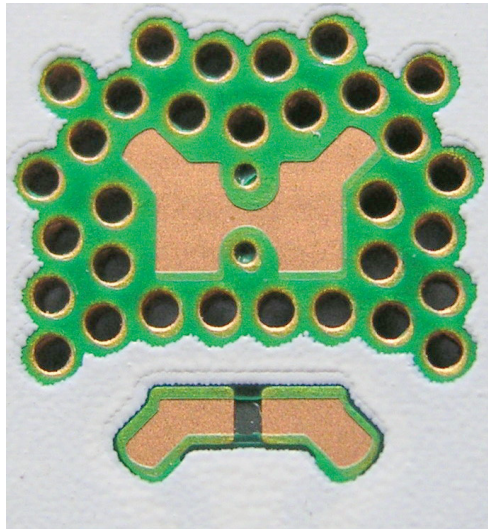

Figure 11. Solder pad layout for LUXEON Rebel PLUS.

Notes for Figure 11:

1. The photograph shows the recommended LUXEON Rebel PLUS layout on Printed Circuit Board (PCB). This design easily achieves a thermal resistance of 7K/W.
2. Application Brief AB32 provides extensive details for this layout. Printed Circuit Board layout files (.dmg) are available at lumileds.com.

Packaging Information

Pocket Tape Dimensions

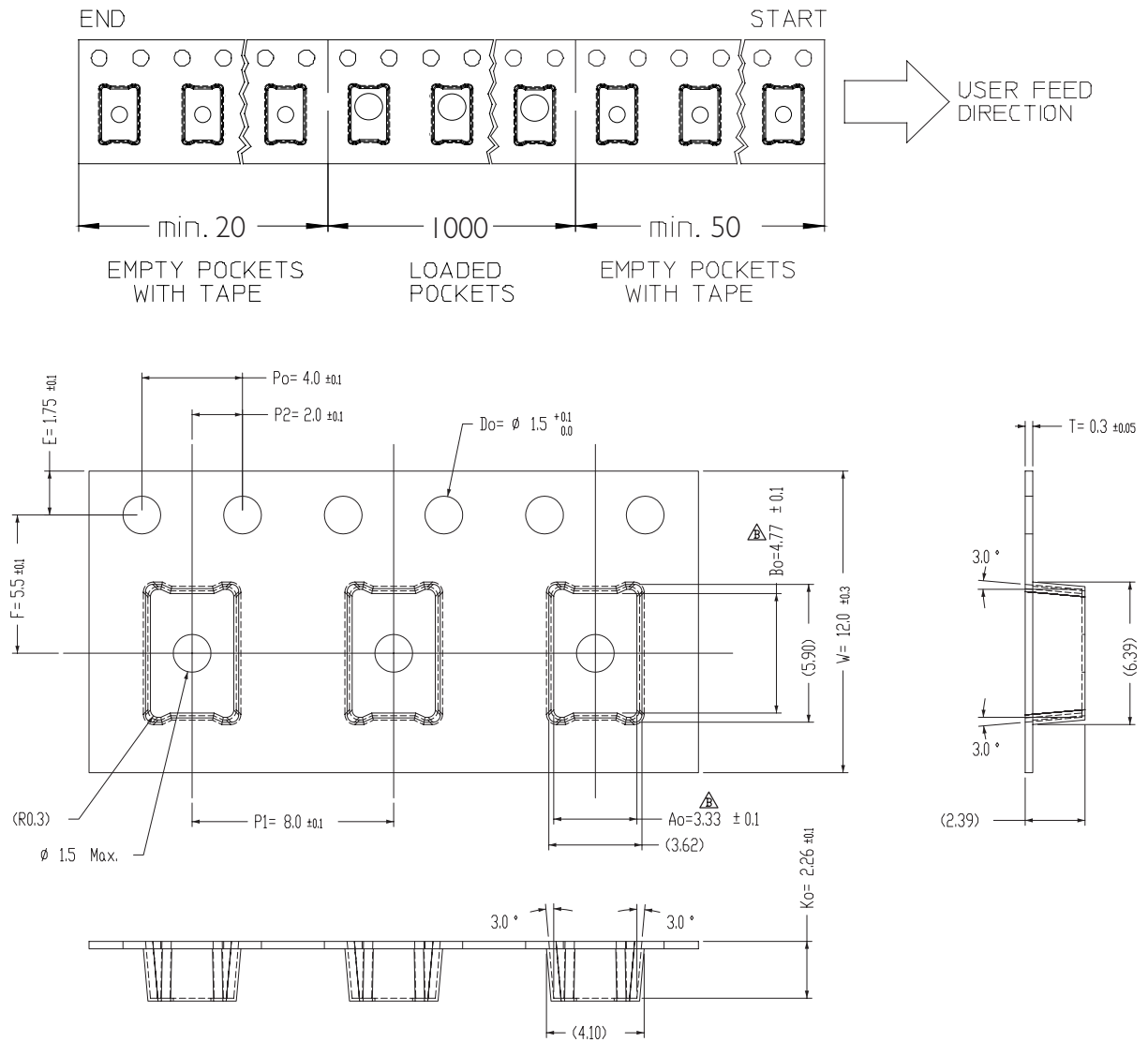

Figure 12. Pocket tape dimensions for LUXEON Rebel PLUS.

Notes for Figure 12:

1. Drawings are not to scale.
2. All dimensions are in millimeters.

Reel Dimensions

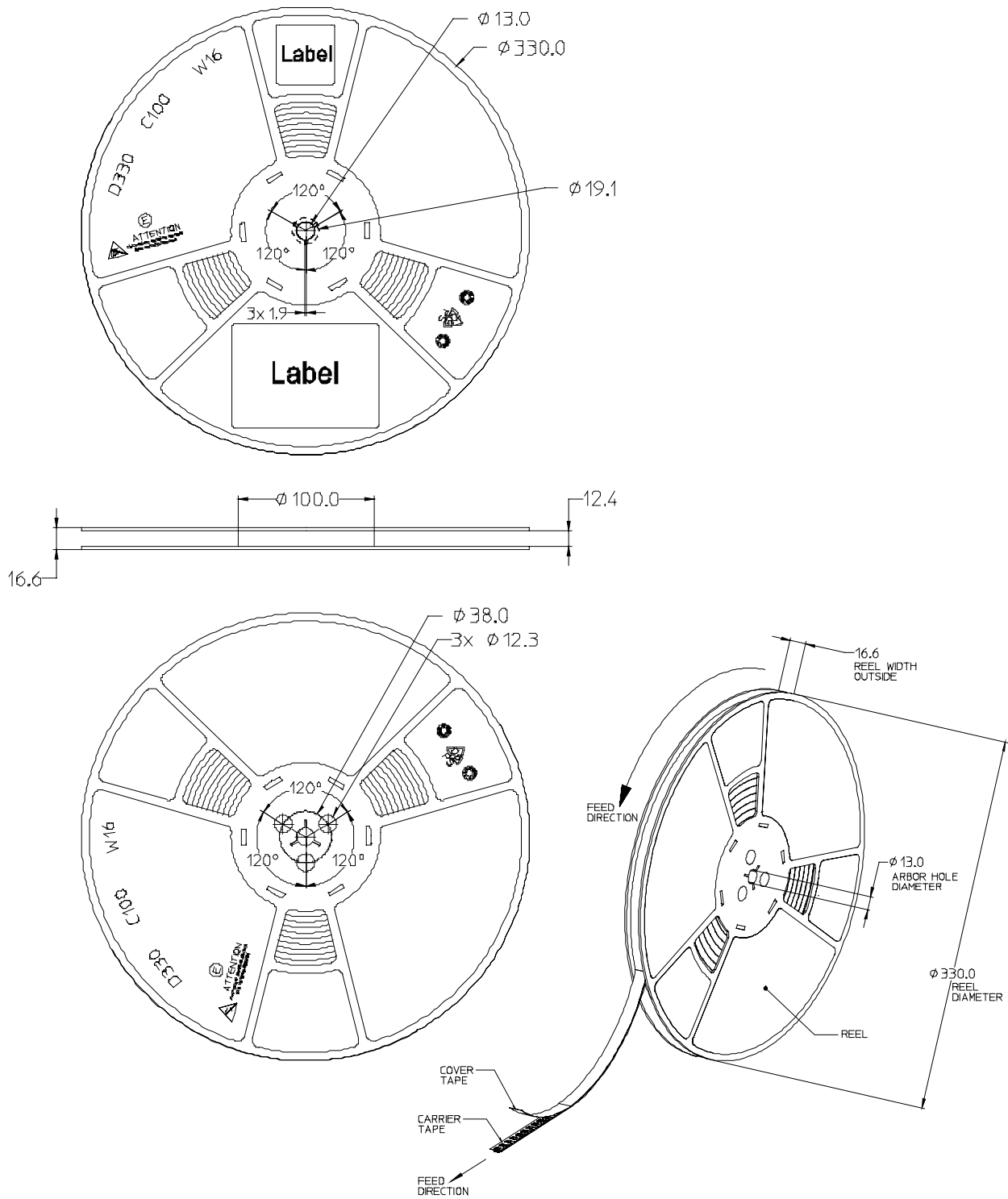

Figure 13. Reel dimensions for LUXEON Rebel PLUS.

Notes for Figure 13:

1. Drawings are not to scale.
2. All dimensions are in millimeters.

About Lumileds

Lumileds is the global leader in light engine technology. The company develops, manufactures and distributes groundbreaking LEDs and automotive lighting products that shatter the status quo and help customers gain and maintain a competitive edge.

With a rich history of industry “firsts,” Lumileds is uniquely positioned to deliver lighting advancements well into the future by maintaining an unwavering focus on quality, innovation and reliability.

To learn more about our portfolio of light engines, visit lumileds.com.



©2017 Lumileds Holding B.V. All rights reserved.
LUXEON is a registered trademark of the Lumileds Holding B.V. in the United States and other countries.

lumileds.com

Neither Lumileds Holding B.V. nor its affiliates shall be liable for any kind of loss of data or any other damages, direct, indirect or consequential, resulting from the use of the provided information and data. Although Lumileds Holding B.V. and/or its affiliates have attempted to provide the most accurate information and data, the materials and services information and data are provided “as is,” and neither Lumileds Holding B.V. nor its affiliates warrants or guarantees the contents and correctness of the provided information and data. Lumileds Holding B.V. and its affiliates reserve the right to make changes without notice. You as user agree to this disclaimer and user agreement with the download or use of the provided materials, information and data. A listing of Lumileds product/patent coverage may be accessed at lumileds.com/patents.