

SAC-5P- 5,0-PUR/M12FR P

Order No.: 1442777



<http://catalog.phoenixcontact.net/phoenix/treeViewClick.do?UID=1442777>

Sensor/Actuator cable, 5-position, PUR halogen-free, black-gray RAL 7021, free cable end, on Socket angled M12, A-coded, Cable length: 5 m, with plastic knurl

Commercial data	
EAN	 4 046356 535687
Note	Made-to-order
sales group	D112
Pack	1 Pcs.
Customs tariff	85444290
Gross weight in pieces	0.1827 KG
Net weight per piece	0.1827 KG
Catalog page information	Page 138 (PC-2011)

Product notes

WEEE/RoHS-compliant since:
09/30/2009



<http://www.download.phoenixcontact.com>
Please note that the data given here has been taken from the online catalog. For comprehensive information and data, please refer to the user documentation. The General Terms and Conditions of Use apply to Internet downloads.

Technical data	
Dimensions	
Length of cable	5 m
Stripping length of the free conductor end	50 mm
Ambient conditions	
Ambient temperature (operation)	-25 °C ... 90 °C (Plug / socket)

Degree of protection	IP65
	IP67
	IP68

General

Rated current at 40°C	4 A
Rated voltage	60 V
Number of positions	5
Contact resistance	≤ 5 mΩ
Insulation resistance	≥ 100 MΩ
Coding	A - standard
Standards/regulations	M12 connector IEC 61076-2-101
Status display	No
Protective circuit/component	Unwired
Surge voltage category	II
Pollution degree	3
Insertion/withdrawal cycles	≥ 100
Torque	0.4 Nm (M12 connector)

Material

Inflammability class according to UL 94	HB
Contact material	CuSn
Contact surface material	Ni/Au
Contact carrier material	TPU GF
Material of grip body	TPU, hardly inflammable, self-extinguishing
Material, knurls	Polyamide
Sealing material	NBR

Cable

Cable type	PUR halogen-free black
Cable type (abbreviation)	PUR
UL AWM style	20549
Conductor cross section	5x 0.34 mm ² (signal line)
AWG signal line	22
Conductor structure signal line	42x 0.10 mm
Core diameter including insulation	1.27 mm ±0.02 mm (signal line)
Thickness, insulation	approx. 0.7 mm

Wire colors	brown, white, blue, black, green-yellow
External sheath, color	black-gray RAL 7021
External cable diameter D	5 mm ±0.15 mm
Smallest bending radius, fixed installation	25 mm
Smallest bending radius, movable installation	50 mm
Number of bending cycles	4000000
Bending radius	50 mm
Traversing path	10 m
Traversing rate	3 m/s
Acceleration	10 m/s ²
Cable weight	35 kg/km
Outer sheath, material	PUR
Conductor material	Bare Cu litz wires
Insulation resistance	≥ 16 GΩ*km (at 20 °C)
Conductor resistance	max. 58 Ω/km (at 20 °C)
Nominal voltage, cable	300 V
Test voltage, cable	3000 V
Special properties	Flexible cable conduit capable
	Silicone-free
	Free of substances which would hinder coating with paint or varnish
	Flexible
Flame resistance	in accordance with DIN UL-Style 20549
Halogen-free	in accordance with DIN VDE 0472 part 815
Resistance to oil	in accordance with DIN EN 60811-2-1
Other resistance	Highly resistant to acids, alkaline solutions and solvents
	hydrolysis and microbe resistant
	Resistant to salt water
	partly UV-resistant in accordance with DIN EN ISO 4892-2-A
Ambient temperature (operation)	-40 °C ... 80 °C (cable, fixed installation)
	-25 °C ... 80 °C (cable, flexible installation)

Certificates / Approvals



Certification GOST

Certifications applied for:

Certification Ex:

Accessories

Item	Designation	Description
Fuse		
1558991	SAC-M12-EXCLIP-F	Fuse clip for the socket side of sensor/actuator cables with M12 connector and M12 connectors which can be assembled with QUICKON fast connection technology, prevents the disconnection of plug-in connections without tools
Marking		
1051993	B-STIFT	Marker pen, for manual labeling of unprinted Zack strips, smear-proof and waterproof, line thickness 0.5 mm
1013944	PABA RD/15	Insert label, Strip, red, unlabeled, can be labeled with: Plotter, Mounting type: Thread on, Cable diameter: 0.6-50 mm, Lettering field: 15 x 4 mm
1013151	PABA WH/15	Insert label, Strip, white, unlabeled, can be labeled with: Plotter, Mounting type: Thread on, Cable diameter: 0.6-50 mm, Lettering field: 15 x 4 mm
1013698	PABA YE/15	Insert label, Strip, yellow, unlabeled, can be labeled with: Plotter, Mounting type: Thread on, Cable diameter: 0.6-50 mm, Lettering field: 15 x 4 mm
1013038	PATG 2/15	Conductor marker carrier, transparent, unlabeled, Mounting type: Slide on, Cable diameter: 2-4 mm, Lettering field: 4 x 15 mm
1013041	PATG 3/15	Conductor marker carrier, transparent, unlabeled, Mounting type: Slide on, Cable diameter: 4-7 mm, Lettering field: 4 x 15 mm
1013054	PATG 4/15	Conductor marker carrier, transparent, unlabeled, Mounting type: Slide on, Cable diameter: 6-10 mm, Lettering field: 4 x 15 mm
Protection and sealing elements		
1430899	PROT-M12 MS-PA-CHAIN	M12 sealing cap with fixing band, for sensor cables, for free M12 sockets
Tools		
1212207	CUTFOX-S VDE	Diagonal cutter for copper and aluminum conductors, VDE-tested
1208432	SAC BIT M12-D15	Nut for assembling sensor/actuator cables with M12 connector and for M12 connectors with QUICKON fast connection technology, for 4 mm hexagonal drive

1208429	TSD 04 SAC	Torque screwdriver, with preset torque of 0.4 Nm and 4 mm hexagonal drive for M12 connectors
1212224	TSD-M 1,2NM	Torque screw driver, accuracy as per EN ISO 6789 standard, adjustable from 0.3 - 1.2 Nm
1212600	TSD-M SAC-BIT ADAPTER	Adapter bit for TSD-M...torque tools, E6.3-1/4" drive with 4 mm hexagon to accommodate SAC bits
1212150	WIREFOX 10	Stripping tool, for cables and conductors from 0.02 - 10 mm ² , self-adjusting, stripping length of up to 18 mm, cutting capacity of up to 10 mm ² stranded/1.5 mm ² solid, replaceable stripping blade
1212623	WIREFOX SAC	Stripping pliers, for halogen-free sensor/actuator cables (SAC cables), with PUR and PVC insulation, from Ø of 4.4 to 7 mm, any stripping length
1212757	WIREFOX SAC-1	Stripping pliers, for halogen-free sensor/actuator cables (SAC cables), with PUR and PVC insulation, from Ø of 3.2 to 4.4 mm, any stripping length

Drawings

Dimensioned drawing

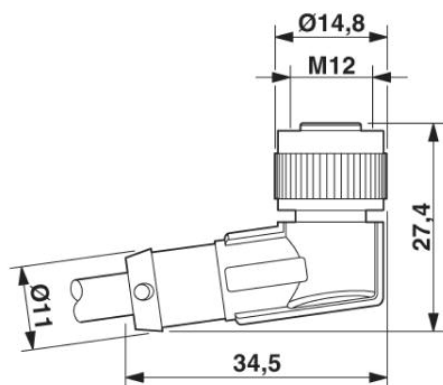

M12 x 1 socket, angled

Circuit diagram

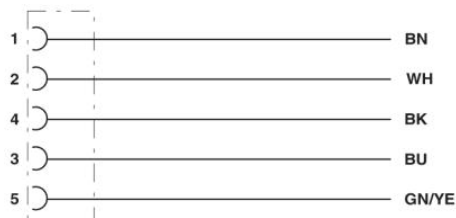

Contact assignment of the M12 sockets

Schematic diagram

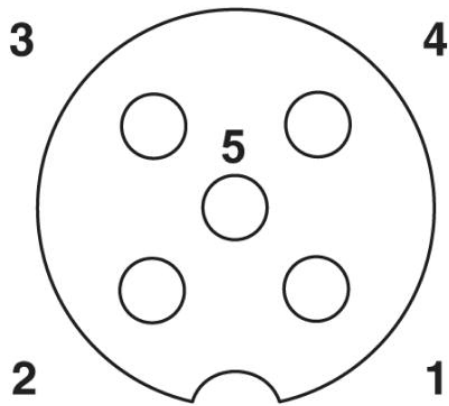

Pin assignment M12 socket, 5-pos., A-coded, socket side view

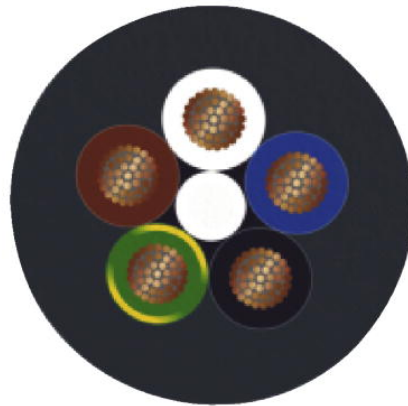

PUR halogen-free black [PUR]

Address

PHOENIX CONTACT Deutschland GmbH
Flachmarktstr. 8
32825 Blomberg, Germany
Phone +49 5235 3 12000
Fax +49 5235 3 41200
<http://www.phoenixcontact.com>



© 2014 Phoenix Contact
Technical modifications reserved;