

SAC-4P- 5,0-542/M8 FR BK

Order No.: 1406242



<http://catalog.phoenixcontact.net/phoenix/treeViewClick.do?UID=1406242>

Sensor/Actuator cable, 4-position, PVC, Yellow RAL 1021, free cable end, on Socket angled M8, Cable length: 5 m



Commercial data	
EAN	 4 046356 798099
Note	Made-to-order
sales group	D111
Pack	1 Pcs.
Customs tariff	85444290
Gross weight in pieces	0.1311 KG
Net weight per piece	0.1234 KG

Product notes

WEEE/RoHS-compliant since:
04/02/2012



<http://www.download.phoenixcontact.com>
Please note that the data given here has been taken from the online catalog. For comprehensive information and data, please refer to the user documentation. The General Terms and Conditions of Use apply to Internet downloads.

Technical data

Dimensions	
Length of cable	5 m
Ambient conditions	
Ambient temperature (operation)	-25 °C ... 90 °C (Plug / socket)

Degree of protection	IP65
	IP67
	IP68

General

Rated current at 40°C	4 A
Rated voltage	30 V
Number of positions	4
Contact resistance	≤ 5 mΩ
Insulation resistance	≥ 100 MΩ
Coding	A - standard
Standards/regulations	M8 connector IEC 61076-2-104
Status display	No
Protective circuit/component	Unwired
Surge voltage category	II
Pollution degree	3
Insertion/withdrawal cycles	≥ 100
Torque	0.2 Nm (M8 connectors)

Material

Inflammability class according to UL 94	HB
Contact material	CuSn
Contact surface material	Ni/Au
Contact carrier material	TPU GF
Material of grip body	TPU, hardly inflammable, self-extinguishing
Material, knurls	Zinc die-cast, nickel-plated
Sealing material	NBR

Cable

Cable type	PVC yellow 105 °C
Cable type (abbreviation)	542
UL AWM style	2517 (105°C/300 V)
AWG signal line	24
Core diameter including insulation	1.12 mm ±0.03 mm
Wire colors	brown, blue, black, white
Overall twist	4 wires, twisted
External sheath, color	yellow

External cable diameter D	4.4 mm ±0.2 mm
Minimum bending radius, flexible installation	8 x D
Cable weight	25 kg/km
Outer sheath, material	PVC
Material conductor insulation	PVC
Conductor material	Tin-plated Cu litz wires
Nominal voltage, cable	300 V
Other resistance	UV resistant
Ambient temperature (operation)	-30 °C ... 105 °C (cable, fixed installation)

Certificates / Approvals



Certification cULus Listed

Certifications applied for:

Certification Ex:

Accessories

Item	Designation	Description
------	-------------	-------------

Protection and sealing elements

1430860	PROT-M 8 MS-PA-CHAIN	M8 sealing cap made of plastic with fixing band for sensor cables, for M8 sockets
---------	----------------------	---

Tools

1208461	SAC BIT M8-D10	Nut for assembling sensor/actuator cables with M8 connector and for M8 connectors with QUICKON fast connection technology, for 4 mm hexagonal drive
1208487	TSD 02 SAC	Torque screwdriver, with preset torque of 0.2 Nm and 4 mm hexagonal drive for M8 connectors

Drawings

Dimensioned drawing

Socket M8 x 1, angled

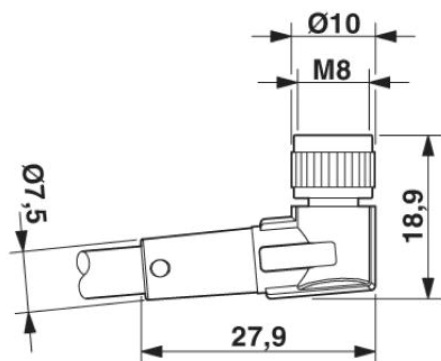

Circuit diagram

Contact assignment of M8 socket

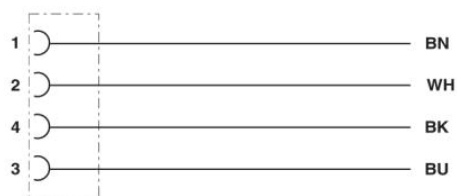

Schematic diagram

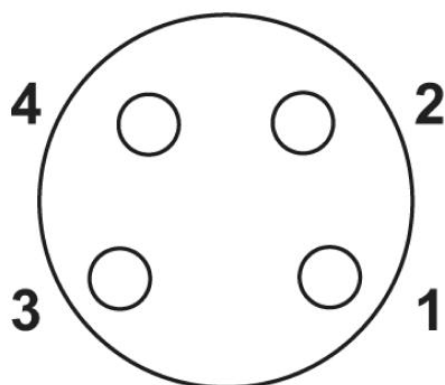

Pin assignment M8 socket, 4-pos., view female side

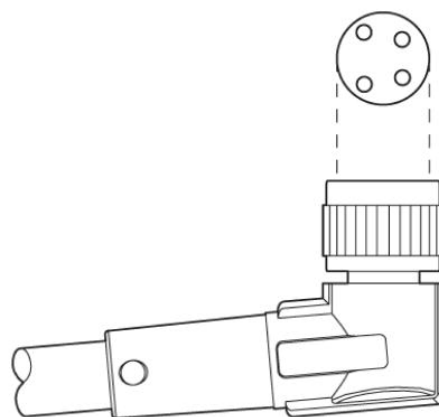

Layout of connector pin assignments

Address

PHOENIX CONTACT Deutschland GmbH
Flachmarktstr. 8
32825 Blomberg, Germany
Phone +49 5235 3 12000
Fax +49 5235 3 41200
<http://www.phoenixcontact.com>



© 2014 Phoenix Contact
Technical modifications reserved;