

SAC-4P-M12MS/5,0-PUR/M12FR

Order No.: 1696400



<http://catalog.phoenixcontact.net/phoenix/treeViewClick.do?UID=1696400>

Sensor/Actuator cable, 4-position, PUR halogen-free, black-gray RAL 7021, Plug straight M12, A-coded, on Socket angled M12, A-coded, Cable length: 5 m

Commercial data	
EAN	 4 017918 483685
sales group	D111
Pack	1 Pcs.
Customs tariff	85444290
Gross weight in pieces	0.1661 KG
Net weight per piece	0.1644 KG

Product notes

WEEE/RoHS-compliant since:
06/01/2005



<http://www.download.phoenixcontact.com>
Please note that the data given here has been taken from the online catalog. For comprehensive information and data, please refer to the user documentation. The General Terms and Conditions of Use apply to Internet downloads.

Technical data	
Dimensions	
Length of cable	5 m
Ambient conditions	
Ambient temperature (operation)	-25 °C ... 90 °C (Plug / socket)

Degree of protection	IP65
	IP67
	IP68

General

Rated current at 40°C	4 A
Rated voltage	250 V
Number of positions	4
Contact resistance	≤ 5 mΩ
Insulation resistance	≥ 100 MΩ
Coding	A - standard
Status display	No
Surge voltage category	II
Pollution degree	3
Insertion/withdrawal cycles	≥ 100

Material

Inflammability class according to UL 94	HB
Contact material	CuSn
Contact surface material	Ni/Au
Contact carrier material	TPU GF
Material of grip body	TPU, hardly inflammable, self-extinguishing
Material, knurls	Zinc die-cast, nickel-plated
Sealing material	NBR

Cable

Cable type	PUR halogen-free black
Cable type (abbreviation)	PUR
Cable abbreviation	Li9Y11Y-HF
UL AWM style	20549 / 10493 (80°C/300 V)
Conductor cross section	4x 0.34 mm ²
AWG signal line	22
Conductor structure signal line	42x 0.10 mm
Core diameter including insulation	1.27 mm ±0.02 mm
Thickness, insulation	≥ 0.21 mm
Wire colors	brown, white, blue, black
Overall twist	4 wires, twisted

External sheath, color	black-gray RAL 7021
Outer sheath thickness	approx. 0.8 mm
External cable diameter D	4.7 mm ±0.15 mm
Minimum bending radius, fixed installation	5 x D
Minimum bending radius, flexible installation	10 x D
Number of bending cycles	4000000
Minimum bending radius, drag chain applications	10 x D
Traversing path	10 m
Traversing rate	3 m/s
Acceleration	10 m/s ²
Cable weight	30 kg/km
Outer sheath, material	PUR
Material conductor insulation	PP
Conductor material	Bare Cu litz wires
Insulation resistance	≥ 1 GΩ*km
Conductor resistance	≤ 58 Ω/km
Nominal voltage, cable	≤ 300 V
Test voltage, cable	≥ 3000 V
Special properties	Flexible cable conduit capable
	Silicone-free
	Free of substances which would hinder coating with paint or varnish
	Flexible
Flame resistance	in accordance with DIN UL-Style 20549
	in accordance with FT1 as per UL 758
Halogen-free	in accordance with DIN VDE 0472 part 815
	in accordance with DIN EN 50267-2-1
Resistance to oil	in accordance with DIN EN 60811-2-1
Other resistance	Highly resistant to acids, alkaline solutions and solvents
	hydrolysis and microbe resistant
	partly UV-resistant in accordance with DIN EN ISO 4892-2-A
	Low adhesion
	abrasion-resistant
Ambient temperature (operation)	-40 °C ... 80 °C (cable, fixed installation)
	-25 °C ... 80 °C (cable, flexible installation)

Certificates / Approvals



Certification cULus Listed

Certifications applied for:

Certification Ex:

Accessories

Item	Designation	Description
Fuse		
1558991	SAC-M12-EXCLIP-F	Fuse clip for the socket side of sensor/actuator cables with M12 connector and M12 connectors which can be assembled with QUICKON fast connection technology, prevents the disconnection of plug-in connections without tools
1558988	SAC-M12-EXCLIP-M	Fuse clip for the pin side of sensor/actuator cables with M12 connector and M12 connectors which can be assembled with QUICKON fast connection technology, prevents the disconnection of plug-in connections without tools

Marking

1051993	B-STIFT	Marker pen, for manual labeling of unprinted Zack strips, smear-proof and waterproof, line thickness 0.5 mm
1013944	PABA RD/15	Insert label, Strip, red, unlabeled, can be labeled with: Plotter, Mounting type: Thread on, Cable diameter: 0.6-50 mm, Lettering field: 15 x 4 mm
1013151	PABA WH/15	Insert label, Strip, white, unlabeled, can be labeled with: Plotter, Mounting type: Thread on, Cable diameter: 0.6-50 mm, Lettering field: 15 x 4 mm
1013698	PABA YE/15	Insert label, Strip, yellow, unlabeled, can be labeled with: Plotter, Mounting type: Thread on, Cable diameter: 0.6-50 mm, Lettering field: 15 x 4 mm
1013122	PATO 2/15	Conductor marker carrier, transparent, unlabeled, Mounting type: clip on, Cable diameter: 2.8-4.4 mm, Lettering field: 4 x 15 mm
1013135	PATO 3/15	Conductor marker carrier, transparent, unlabeled, Mounting type: clip on, Cable diameter: 4.4-6.7 mm, Lettering field: 4 x 15 mm
1013148	PATO 4/15	Conductor marker carrier, transparent, unlabeled, Mounting type: clip on, Cable diameter: 6.7-10 mm, Lettering field: 4 x 15 mm

Protection and sealing elements

1430873	PROT-M12 FS-PA-CHAIN	M12 sealing cap made of plastic with fixing band, for sensor cables, for free M12 sockets
1430899	PROT-M12 MS-PA-CHAIN	M12 sealing cap with fixing band, for sensor cables, for free M12 sockets

Tools

1208432	SAC BIT M12-D15	Nut for assembling sensor/actuator cables with M12 connector and for M12 connectors with QUICKON fast connection technology, for 4 mm hexagonal drive
1208429	TSD 04 SAC	Torque screwdriver, with preset torque of 0.4 Nm and 4 mm hexagonal drive for M12 connectors
1212224	TSD-M 1,2NM	Torque screw driver, accuracy as per EN ISO 6789 standard, adjustable from 0.3 - 1.2 Nm
1212600	TSD-M SAC-BIT ADAPTER	Adapter bit for TSD-M...torque tools, E6.3-1/4" drive with 4 mm hexagon to accommodate SAC bits

Drawings

Dimensioned drawing

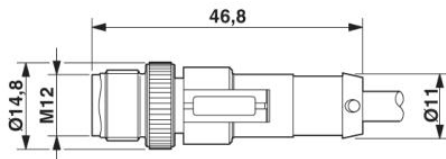

M12 x 1 plug, straight

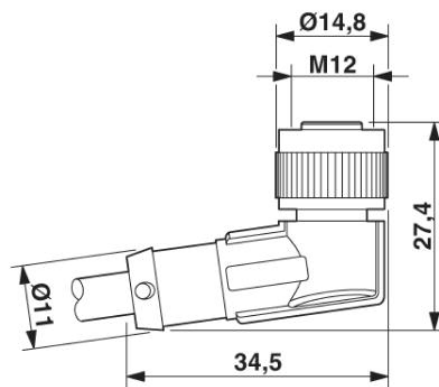

M12 x 1 socket, angled

Circuit diagram

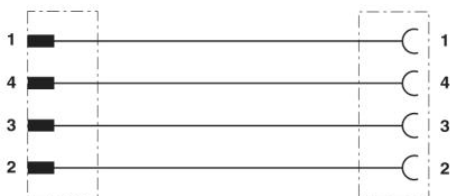

Contact assignment of the M12 plug and the M12 socket

Schematic diagram

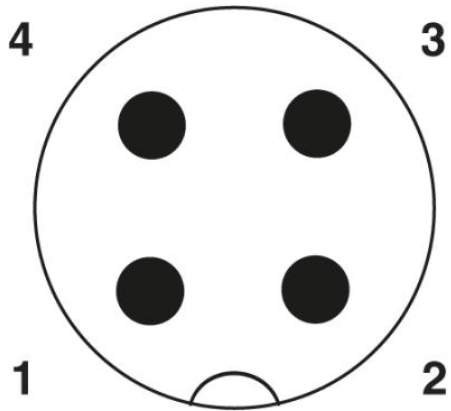

Pin assignment M12 plug, 4-pos., A-coded, view plug side

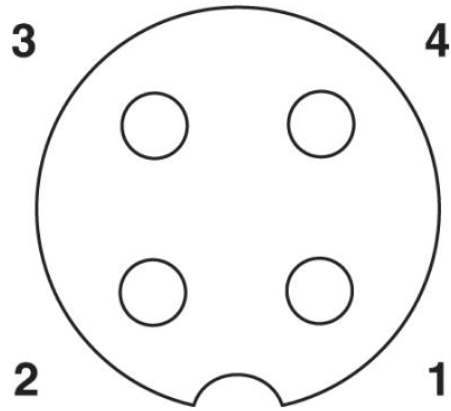

Pin assignment M12 socket, 4-pos., A-coded, view female side

PUR halogen-free black [PUR]

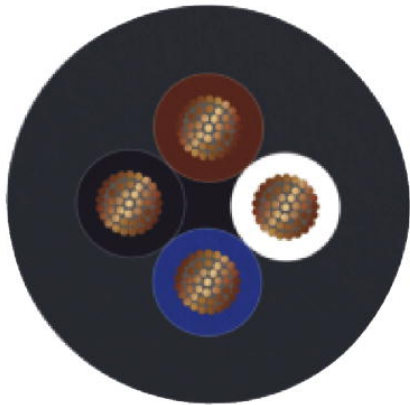

Address

PHOENIX CONTACT Deutschland GmbH
Flachmarktstr. 8
32825 Blomberg, Germany
Phone +49 5235 3 12000
Fax +49 5235 3 41200
<http://www.phoenixcontact.com>



© 2014 Phoenix Contact
Technical modifications reserved;