

SAC-5P-MS/0,5-542/ FRSH SCO BK

Order No.: 1406135



<http://catalog.phoenixcontact.net/phoenix/treeViewClick.do?UID=1406135>

Sensor/Actuator cable, 5-position, PVC, Yellow RAL 1021, shielded, Plug straight M12 SPEEDCON, A-coded, on Socket angled M12 SPEEDCON, A-coded, Cable length: 0.5 m



Product notes

WEEE/RoHS-compliant since:
04/03/2012



Commercial data

EAN	 4 046356 799140
Note	Made-to-order
sales group	D117
Pack	1 Pcs.
Customs tariff	85444290
Gross weight in pieces	0.06695 KG
Net weight per piece	0.06695 KG

<http://www.download.phoenixcontact.com>
Please note that the data given here has been taken from the online catalog. For comprehensive information and data, please refer to the user documentation. The General Terms and Conditions of Use apply to Internet downloads.

Technical data

Dimensions

Length of cable	0.5 m
-----------------	-------

Ambient conditions

Ambient temperature (operation)	-25 °C ... 90 °C (Plug / socket)
Degree of protection	IP65
	IP67

General

Rated current at 40°C	4 A
Rated voltage	60 V
Number of positions	5
Contact resistance	≤ 5 mΩ
Insulation resistance	≥ 100 MΩ
Coding	A - standard
Standards/regulations	M12 connector IEC 61076-2-101
Status display	No
Protective circuit/component	Unwired
Surge voltage category	II
Pollution degree	3
Insertion/withdrawal cycles	≥ 100
Torque	0.4 Nm (M12 connector)

Material

Inflammability class according to UL 94	HB
Contact material	CuSn
Contact surface material	Ni/Au
Contact carrier material	TPU GF
Material of grip body	TPU, hardly inflammable, self-extinguishing
Material, knurls	Zinc die-cast, nickel-plated
Sealing material	NBR

Cable

Cable type	PVC yellow 105 °C
Cable type (abbreviation)	542
UL AWM style	2517 (105°C/300 V)
AWG signal line	22
Core diameter including insulation	1.27 mm ±0.03 mm
Wire colors	Brown, blue, black, white, gray
Overall twist	5 wires around filler to the core
Shielding	Tinned copper braided shield
Optical shield covering	85 %
External sheath, color	yellow
External cable diameter D	5.9 mm ±0.2 mm

Minimum bending radius, flexible installation	12 x D
Cable weight	57 kg/km
Outer sheath, material	PVC
Material, filler	PP
Material conductor insulation	PVC
Conductor material	Tin-plated Cu litz wires
Nominal voltage, cable	300 V
Special properties	UL standards PLTC and ITC
Other resistance	UV resistant
Ambient temperature (operation)	-30 °C ... 105 °C (cable, fixed installation)

Certificates / Approvals

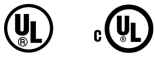

Certification cULus Listed

Certifications applied for:

Certification Ex:

Accessories

Item	Designation	Description
Fuse		
1558991	SAC-M12-EXCLIP-F	Fuse clip for the socket side of sensor/actuator cables with M12 connector and M12 connectors which can be assembled with QUICKON fast connection technology, prevents the disconnection of plug-in connections without tools
1558988	SAC-M12-EXCLIP-M	Fuse clip for the pin side of sensor/actuator cables with M12 connector and M12 connectors which can be assembled with QUICKON fast connection technology, prevents the disconnection of plug-in connections without tools

Protection and sealing elements

1430873	PROT-M12 FS-PA-CHAIN	M12 sealing cap made of plastic with fixing band, for sensor cables, for free M12 sockets
1430899	PROT-M12 MS-PA-CHAIN	M12 sealing cap with fixing band, for sensor cables, for free M12 sockets

Tools

1208432	SAC BIT M12-D15	Nut for assembling sensor/actuator cables with M12 connector and for M12 connectors with QUICKON fast connection technology, for 4 mm hexagonal drive
1208429	TSD 04 SAC	Torque screwdriver, with preset torque of 0.4 Nm and 4 mm hexagonal drive for M12 connectors
1212224	TSD-M 1,2NM	Torque screw driver, accuracy as per EN ISO 6789 standard, adjustable from 0.3 - 1.2 Nm
1212600	TSD-M SAC-BIT ADAPTER	Adapter bit for TSD-M...torque tools, E6.3-1/4" drive with 4 mm hexagon to accommodate SAC bits

Drawings

Dimensioned drawing

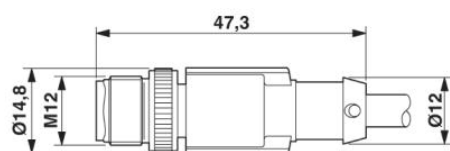

Plug, M12 x 1, straight, shielded

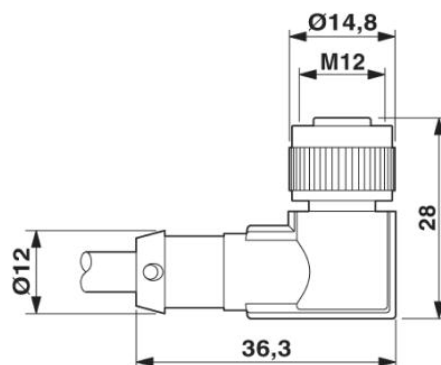

M12 x 1 socket, angled, shielded

Circuit diagram

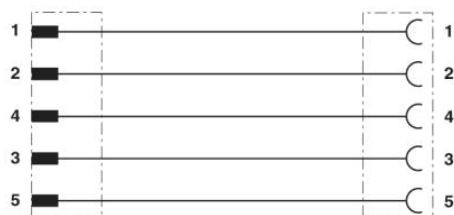

Contact assignment of the M12 plug and the M12 socket

Schematic diagram

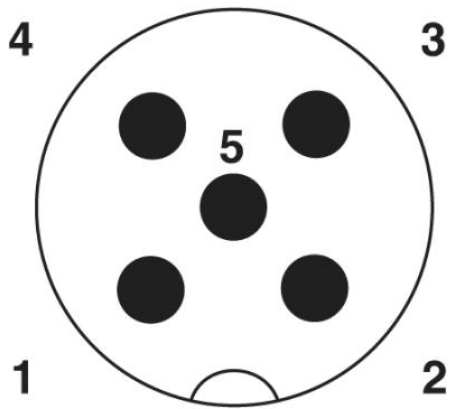

Pin assignment M12 male connector, 5-pos., A-coded, male side

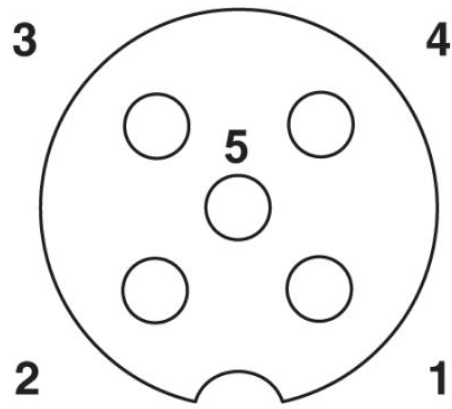

Pin assignment M12 socket, 5-pos., A-coded, socket side view

Address

PHOENIX CONTACT Deutschland GmbH
Flachmarktstr. 8
32825 Blomberg, Germany
Phone +49 5235 3 12000
Fax +49 5235 3 41200
<http://www.phoenixcontact.com>



© 2014 Phoenix Contact
Technical modifications reserved;