

CC 2,5/ 2-GF-5,08-LR P26THR

Order No.: 1792627

<http://catalog.phoenixcontact.net/phoenix/treeViewClick.do?UID=1792627>

Header, Nominal current: 12 A, Rated voltage (III/2): 320 V, Number of positions: 2, Pitch: 5.08 mm, Color: black, Contact surface: Tin, Assembly: SMD/THT/THR

Commercial data	
EAN	 4 046356 615631
Note	Made-to-order
sales group	E172
Pack	50 Pcs.
Customs tariff	85366990
Gross weight in pieces	0.00242 KG
Net weight per piece	0.00242 KG
Catalog page information	Page 299 (C-1-2013)

Product notes

WEEE/RoHS-compliant since:
08/18/2010



<http://www.download.phoenixcontact.com>
Please note that the data given here has been taken from the online catalog. For comprehensive information and data, please refer to the user documentation. The General Terms and Conditions of Use apply to Internet downloads.

Technical data	
Dimensions	
Length	12 mm
Height	11.2 mm
Pitch	5.08 mm
Dimension a	5.08 mm
Pin dimensions	1 x 1 mm
Hole diameter	1.6 mm

General

Range of articles	CC 2,5/...-GF-LR
Insulating material group	IIIa
Rated surge voltage (III/3)	4 kV
Rated surge voltage (III/2)	4 kV
Rated surge voltage (II/2)	4 kV
Rated voltage (III/3)	250 V
Rated voltage (III/2)	320 V
Rated voltage (II/2)	400 V
Connection in acc. with standard	EN-VDE
Nominal current I _N	12 A
Insulating material	LCP
Inflammability class according to UL 94	V0
Color	black
Number of positions	2

Certificates / Approvals



Certification

cULus Recognized, GOST

Certifications applied for:

Certification Ex:

Drawings

Drilling plan/solder pad geometry

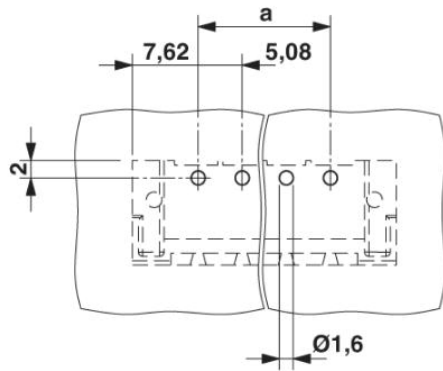

Dimensioned drawing

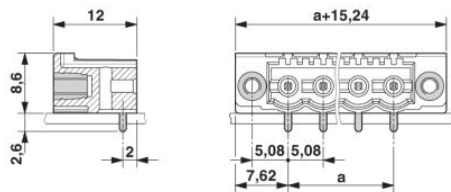

Schematic diagram

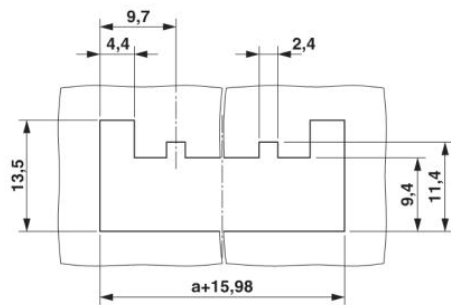

Panel cutout

Address

PHOENIX CONTACT Deutschland GmbH
Flachmarktstr. 8
32825 Blomberg, Germany
Phone +49 5235 3 12000
Fax +49 5235 3 41200
<http://www.phoenixcontact.com>



© 2014 Phoenix Contact
Technical modifications reserved;